

CSR | Corporate Social Responsibility 2010

Environmental Report

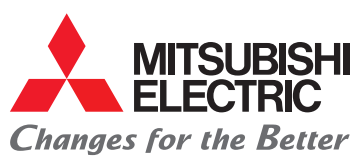
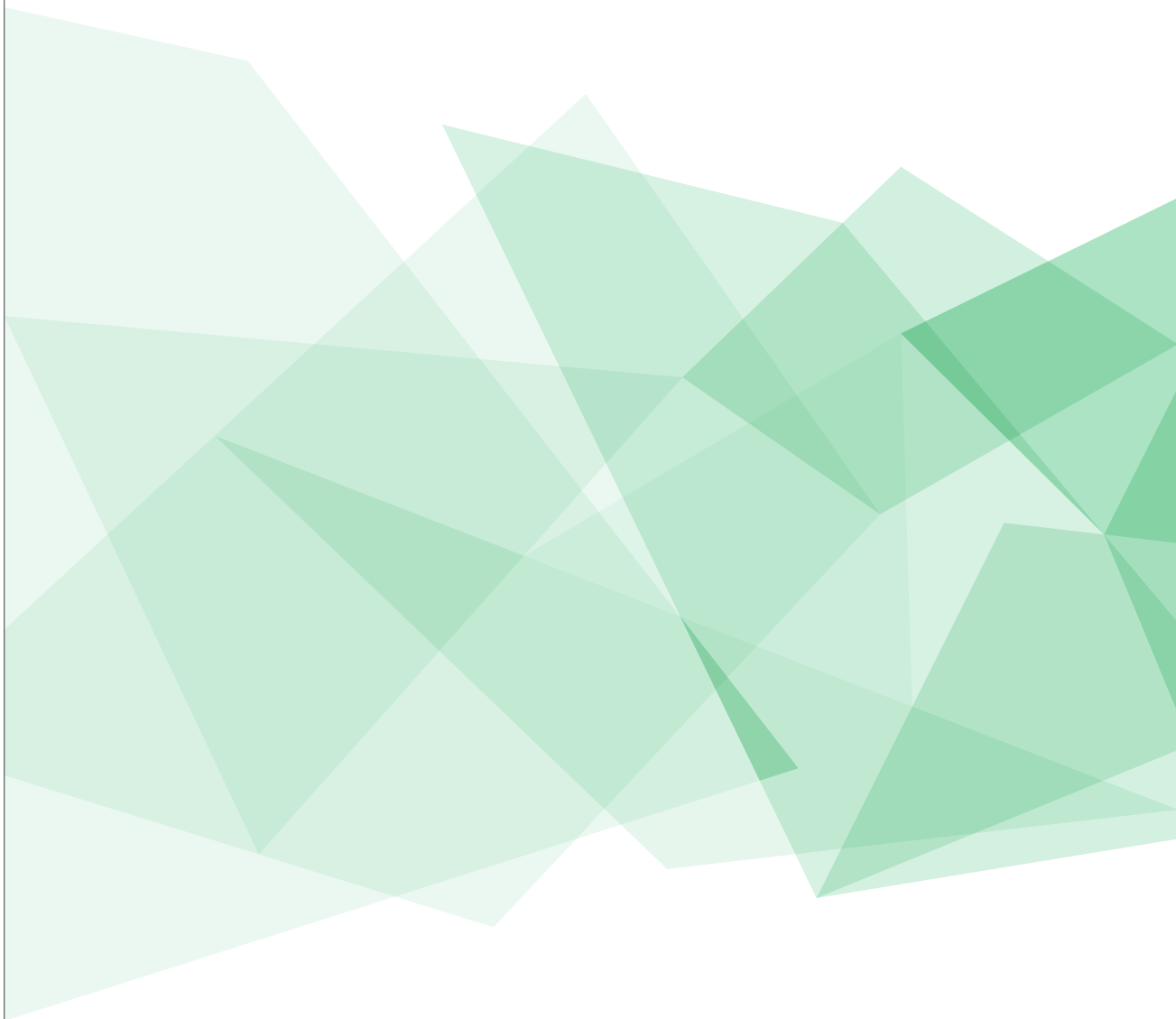

Contents

Environmental Report	1
Policy, Vision & Plan	3
Group Environmental Policy	4
Environmental Statement: Eco Changes	5
Environmental Vision 2021	6
Aiming to Be a Leading Environmental Company	11
6th Environmental Plan (Fiscal 2010–2012)	13
Evolution of the Environmental Plan	26
Targets & Achievements of the 6th Environmental Plan	27
Environmental Management	34
Aiming to Achieve Environmental Vision 2021	35
Expanding Global Environmental Management	36
Expanding ISO 14001 Conformity	42
Complying with Environmental Regulations	44
Efforts towards Compliance	45
Environmental Risk Management	46
Environmental Audits	48
Environmental Education	51
Training Key Environmental Personnel	53
Environmental Communication	55
Product-Related Initiatives	61
Design for Environment	62
Basic Stance	63
Calculating Factor X	65
Reducing CO2 from Product Usage	67
Reducing Resource Inputs	70
Progress in Fiscal 2010	71
Closed-Loop Recycling of Plastics	73
Complying with Chemical Substance Regulations	75
Green Accreditation System	76
Status of RoHS Compliance	77
Status of REACH Compliance	78
Recycling End-of-Life Products	79
Product Environmental Data	84
Energy & Electric Systems	85

Contents

Ozone Generator	86
Super Energy Efficient Transformers	88
Elevator Systems	90
Escalator	91
Industrial Automation Systems	92
Electronic Hybrid Functional Control Panel	93
Computerized Numerical Controller M700VS Series	94
Wire Electric Discharge Machine	95
Automatic Power Factor Controller	97
Electronic Measuring Instrument	98
Electronic Multi-Measuring Instrument	100
Energy Measuring Unit	101
Laser Processing Machine	102
EPS Motor	103
Spindle Motor	105
Information & Communication Systems	106
Optical Network Unit	107
Mitsubishi Logistics Information System: Dr. Logis	109
Integrated Environmental Information System	110
Environmentally Resistant Wide-Area Optical Ethernet Switch	112
UHF-Band RFID Reader-Writer	113
WDM Optical Transmission Equipment	114
Information Equipment Recycling Service	116
Electronic Devices	118
DIP-IPM Module	119
Laminated Bus Bar	121
Home Appliances	123
Jet Towel Hand Dryer	124
Hot Water Floor Heating System	125
Compact Cube for Commercial Use	127
Room Air Conditioner	129
Refrigerator	131
Photovoltaic Module	133
Photovoltaic Inverter	135
Eco Cute for Household Use	137

Contents

Eco Cute for Commercial Applications	140
Ventilator	141
Energy Recovery Ventilator for Commercial Use	143
Lossnay Central Ventilator System	145
<hr/>	
Environmental Contribution in Business	147
Environment-Related Business	148
Reducing CO ₂ through Business Activities	149
Photovoltaic Systems Business	150
Heat Pump-Related Business	152
Power Devices Business	154
Reducing CO ₂ from Power Generation	156
<hr/>	
Production & Logistics-Related Initiatives	159
Reducing CO ₂ from Production	160
Reducing Emissions of Non-CO ₂ Greenhouse Gases	171
Zero Emissions	173
Using Water Effectively	177
Managing Chemical Substances	180
Managing Chemical Substances in Production	181
Reducing VOC Emissions	184
Reducing CO ₂ from Logistics	186
Reducing the Use of Disposable Packaging Materials	190
<hr/>	
Respecting Biodiversity	194
Group Biodiversity Action Guidelines	195
Business Activities and Biodiversity	197
Fostering Environmental Awareness	199
<hr/>	
Fiscal 2009 Achievements	203
Scope of Report	204
Material Balance	205
Environmental Accounting	210
Environmental Performance Data	216
Awards	248



[▶ Mitsubishi Electric Group Environmental Vision 2021—Overview](#)  (1.35 MB)

▶ Policy, Vision & Plan



Group Environmental Policy
Environmental Statement: Eco Changes
Environmental Vision 2021
Aiming to be a Leading Environmental Company
6th Environmental Plan
Evolution of the Environmental Plan

▶ Targets & Achievements of the 6th Environmental Plan



An overview and self-evaluation of progress and achievements made by the Mitsubishi Electric Group in fiscal 2010, vis-a-vis the targets set out in the 6th Environmental Plan.

▶ Environmental Management



Aiming to Achieve Environmental Vision 2021
Expanding Global Environmental Management
Expanding ISO 14001 Conformity
Complying with Environmental Regulations
Environmental Audits
Environmental Education
Training Key Environmental Personnel
Environmental Communication

▶ Product-Related Initiatives



Design for Environment
Reducing CO₂ from Product Usage
Reducing Resource Inputs
Complying with Chemical Substance Regulations
Recycling End-of-Life Products

▶ Product Environmental Data



Energy & Electric Systems
Industrial Automation Systems
Information & Communication Systems
Electronic Devices
Home Appliances

▶ Environmental Contribution in Business



Environment-Related Businesses
Reducing CO₂ from Power Generation

▶ **Production & Logistics-
Related Initiatives**



- Reducing CO2 from Production
- Reducing Emissions of Non-CO2 Greenhouse Gases
- Zero Emissions
- Using Water Effectively
- Managing Chemical Substances
- Reducing CO2 from Logistics
- Reducing the Use of Disposable Packaging Materials

▶ **Respecting
Biodiversity**



- Group Biodiversity Action Guidelines
- Business Activities and Biodiversity
- Fostering Environmental Awareness

▶ **Data & Charts**

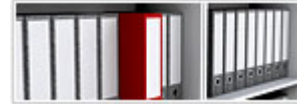

- Scope of Report
- Material Balance
- Environmental Accounting
- Environmental Performance Data
- Awards

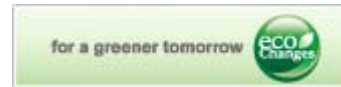

[Back Issues](#)



Environmental Report

Policy, Vision & Plan



▶ Group Environmental Policy

Learn more about our environmental policy, which forms the basis of the Mitsubishi Electric Group's environmental management system.

▶ Environmental Statement: Eco Changes

Read about the Mitsubishi Electric Group's environmental corporate statement, introduced globally in July 2010.

▶ Environmental Vision 2021

Find out about Mitsubishi Electric's long-range vision, with specific targets to be achieved by the year 2021, the centennial of the company's founding.

▶ Aiming to Be a Leading Environmental Company

Read about the Mitsubishi Electric Group's aspiration to become a "200-year company" through energy- and resource-efficient manufacturing and environment-related business.

▶ 6th Environmental Plan (Fiscal 2010-2012)

Learn more about our current environmental plan, including its background and focus, points of emphasis and specific activities.

▶ Evolution of the Environmental Plan

Our environmental plan is reformulated every three years. Follow the evolution from initial development to the current 6th Environmental Plan.

Group Environmental Policy

Mitsubishi Electric Group Environmental Policy

The Mitsubishi Electric Group recognizes that our planet needs to be protected for future generations. Limiting our impact on the environment is thus one of our top management priorities. While respecting social norms, we shall endeavor in our business activities to realize a sustainable society through technology and action.

We will apply our technological expertise and new innovations to reduce the environmental impact of our business and to help preserve biodiversity. The Mitsubishi Electric Group will also strive to make positive contributions through the continuous improvement of our products and services, focusing on size and weight reduction, high performance, resource savings and energy efficiency.

We encourage employees and their families to take part in environmental activities with their communities, and thereby foster environmental awareness. As a responsible corporate citizen, we will also inform the public about our environmental initiatives to promote mutual understanding.

In addition to abiding by the law and respecting social norms, we shall remain sensitive to societal changes and make environmental consideration a permanent part of our activities.

As represented by our corporate statement "Changes for the Better", our ultimate aim is to improve the quality of people's lives while making positive contributions to the Earth's environment.

May 2010
President & CEO
Kenichiro Yamanishi

Environmental Statement: Eco Changes

for a greener tomorrow



Eco Changes is the Mitsubishi Electric Group's environmental statement, and expresses the Group's stance on environmental management. Through a wide range of businesses for homes, offices, factories, infrastructure and even outer space, we are helping contribute to the realization of a sustainable society.

In line with the Mitsubishi Electric Group's corporate statement, "Changes for the Better," which reflects our drive to always seek improvement and make changes accordingly, Eco Changes represents our efforts to work together with our customers to change the global environment for the better. Behind these multifold improvements is our wish for each employee in the Group to instigate positive changes, and our strong desire to bring about a variety of changes in product development, production and shipping, in product, system and service usage, and in recycling.

Eco Changes is the Mitsubishi Electric Group's commitment to continuously strive for a greener tomorrow through cutting-edge global environmental technologies and outstanding strength in manufacturing.

Eco Changes Logo Design Concept

The logo's vivid green sphere represents the world of changes for the better, from in the home to outer space. The "movement" design expresses the improvements made by employees, and the taking of immediate action along with our customers to bring positive changes to society.

News Releases

June 30, 2010

Mitsubishi Electric Introduces "Eco Changes" Statement Outside Japan  (28KB)



Learn more about Eco Changes and the activities related to it.

Environmental Vision 2021

Environmental Vision 2021 is the long-term environmental management vision of the Mitsubishi Electric Group. With the guideline of making positive contributions to the earth and its people through technology and action, the Company is working toward the realization of a sustainable society utilizing wide-ranging and sophisticated technologies as well as the promotion of proactive and ongoing actions by our employees. The Vision sets 2021 as its target year, coinciding with the 100th anniversary of Mitsubishi Electric's founding.

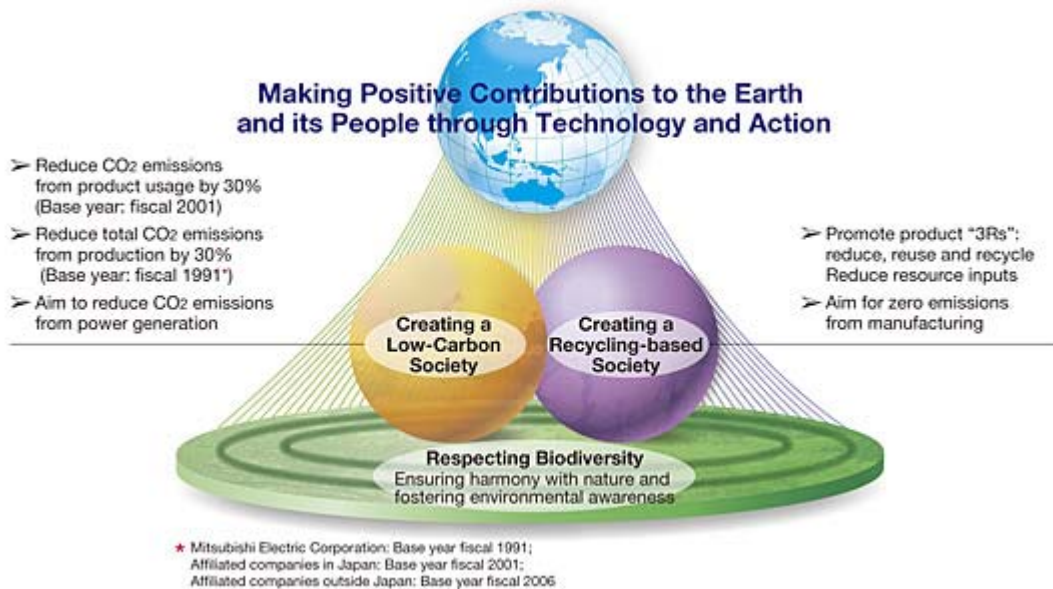

Creating a Low-Carbon Society

To help create a low-carbon society, we will:

- Work to create and popularize innovative energy-saving products to achieve the goal of reducing CO₂ emissions from product usage by 30% compared to fiscal 2001
- Strive to reduce CO₂ emissions from product production by 30% (520,000 tons) across the entire Mitsubishi Electric Group as a prerequisite for sustainable growth
- Reduce CO₂ emissions from power generation and contribute to the creation of a low-carbon society by supplying the power industry with products and systems that do not emit CO₂, including solar power and nuclear power systems

Creating a Recycling-Based Society

To help create a recycling-based society, we will:

- Develop sustainable resource cycles by reducing waste output, reusing resources and recycling resources to give them new life
- Strive for zero waste output from production processes

Respecting Biodiversity: Ensuring Harmony with Nature and Fostering Environmental Awareness

To help ensure harmony with nature and cultivate greater environmental awareness, we will:

- Strive to respect biodiversity in our business activities
- Teach employees the importance of maintaining harmony with nature by providing opportunities for nature observation and direct participation in conservation activities to inculcate autonomous actions for the sake of the environment
- Engage in nature conservation activities to restore damaged woodland environments

Efforts Focused on the creation of a Low-Carbon Society

Aiming to Reduce CO₂ Emissions from Product Usage by 30%

Contributing to the creation of a low-carbon society through the provision of a wide variety of energy-saving products.

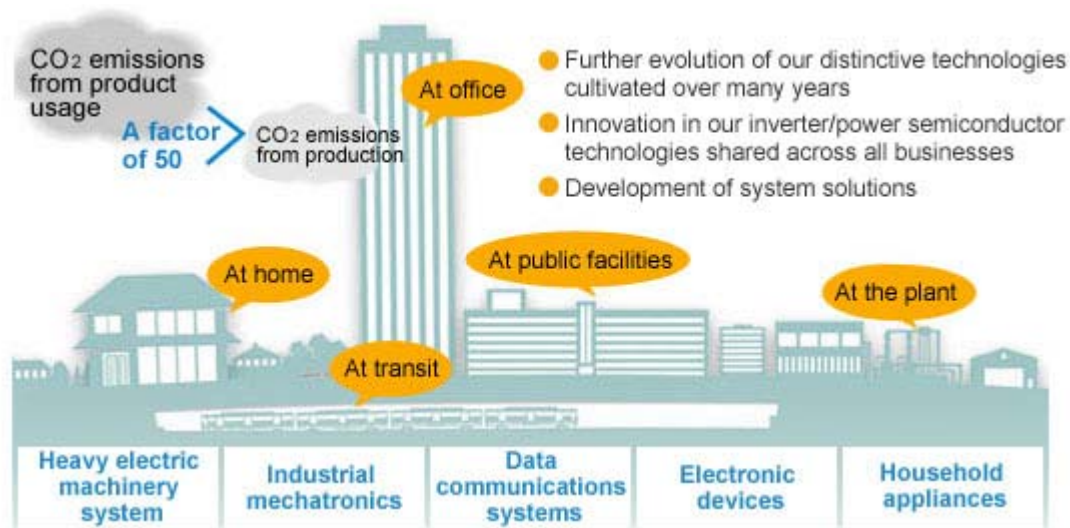

Aiming to Reduce Total CO2 Emissions from Production by 30%

Raising the efficiency and performance of air conditioning, lighting and other utility equipment, as well as improving production lines to reduce the amount of CO2 emitted during production and contributing to the creation of a low-carbon society.

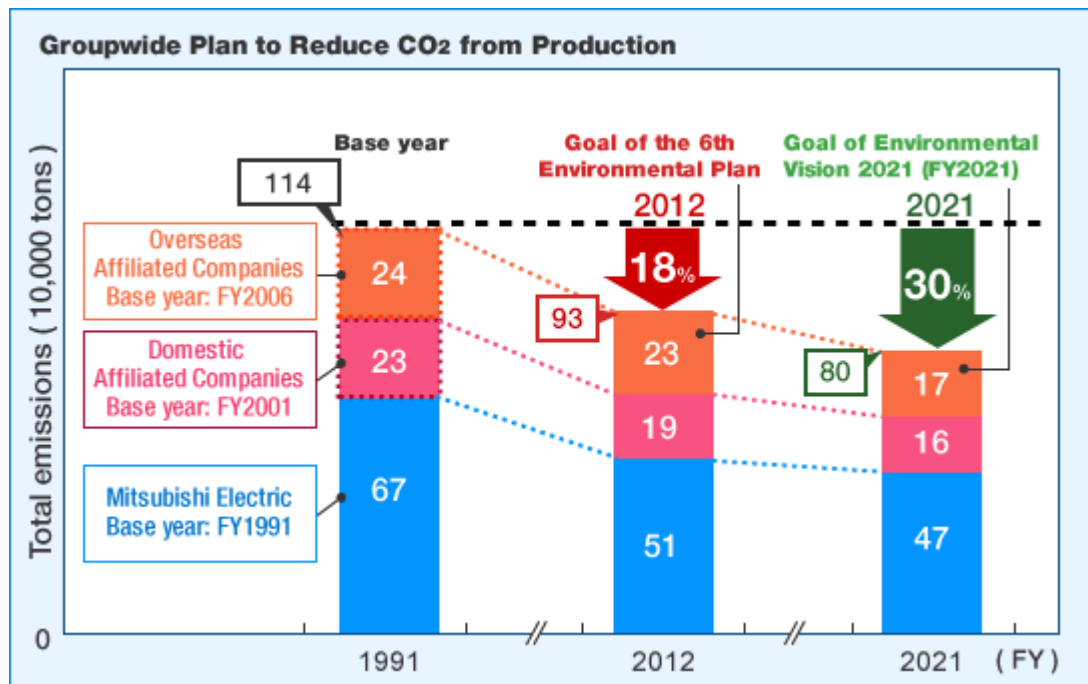

Helping to Reduce CO2 Emissions from Power Generation

We will help reduce CO2 emissions from power generation and contribute to the creation of a low-carbon society by supplying the power industry with products and systems that do not emit CO2, including photovoltaic power and nuclear power systems.

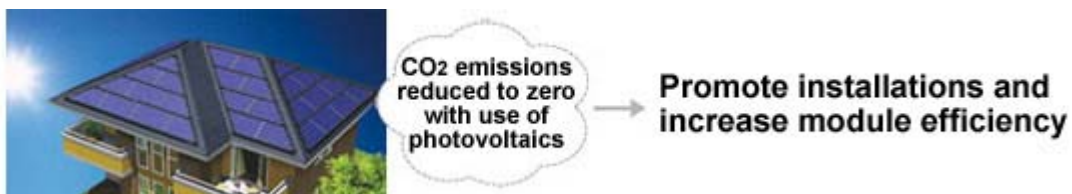

Initiatives to Help Create a Recycling-Based Society

Making Use of DfE and LCA Technologies to Promote the 3Rs

Creating products that contribute to the 3Rs (reduce, reuse and recycle) throughout the product lifecycle.

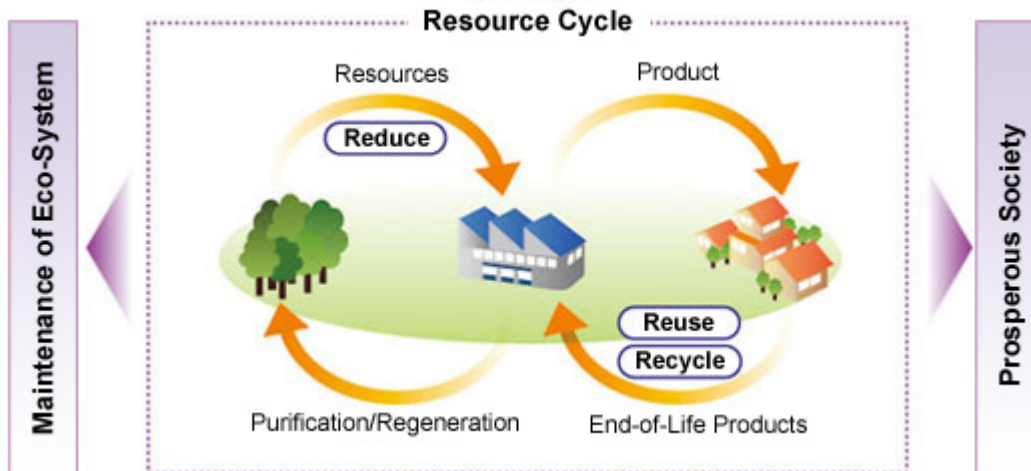

Zero Emissions (Eliminating Waste that Heads Directly to Landfill)

Restricting the generation of waste and promoting the efficient reuse and resource reconversion of waste.

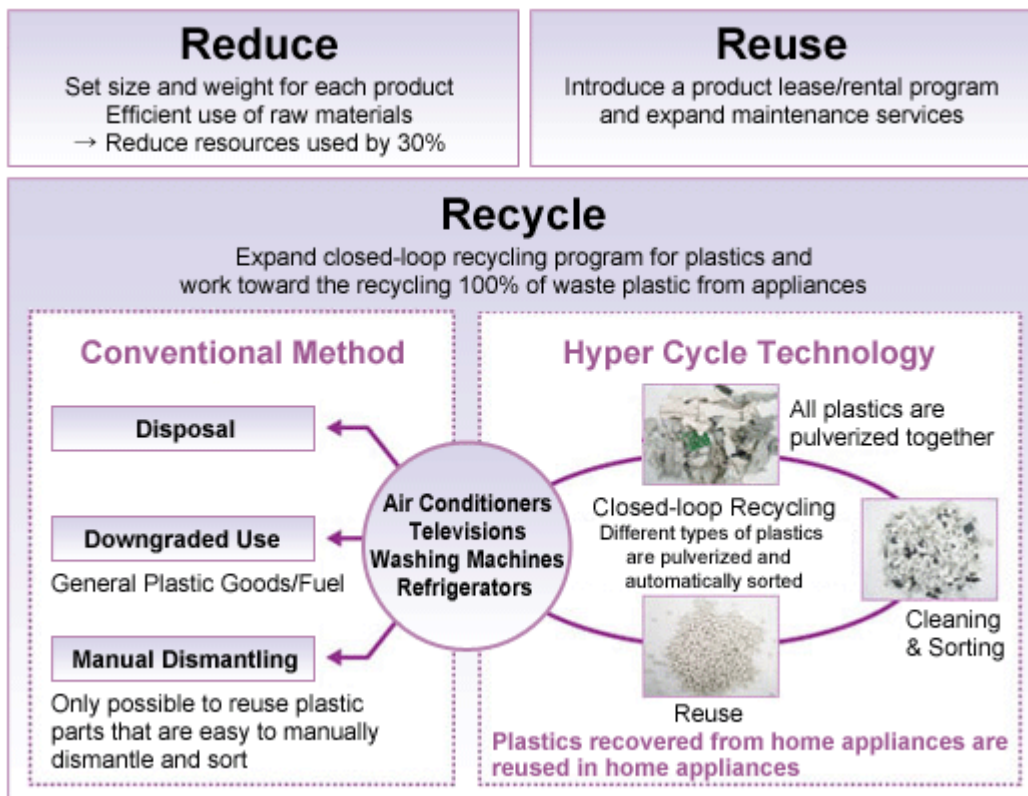

Respecting Biodiversity : Ensuring Harmony with Nature and Fostering Environmental Awareness

Mitsubishi Electric Outdoor Classroom and Leadership Training

We provide education for children and leadership training for 1,000 people in the promotion of nature observation and conservation.



Forest Development

Reforestation aids in the creation of a low-carbon society, protects against natural disasters, and contributes to the preservation of biodiversity.

Woodland preservation activities involve local residents, employees, families, and nearly one million people from all over the world join forces to engage in this nature conservation activity.

Aiming to Be a Leading Environmental Company

Based on its long-term Environmental Vision 2021, the Mitsubishi Electric Group is striving to create a low-carbon, recycling-based society, and helping contribute through its business activities to the development of a sustainable society.

Specifically, we are promoting greater energy and resource efficiency through reducing CO₂ emissions from production and reducing resource inputs. We are also carrying out initiatives to reduce society's overall CO₂ emissions through improvements in product energy-saving performance.

Through these activities, the Mitsubishi Electric Group is furthering its environmental management to enhance its corporate structure and contribute to society, with the aim of becoming a lasting, leading environmental company.

Environmental Vision 2021

Environmental Vision 2021 Conceptual Diagram



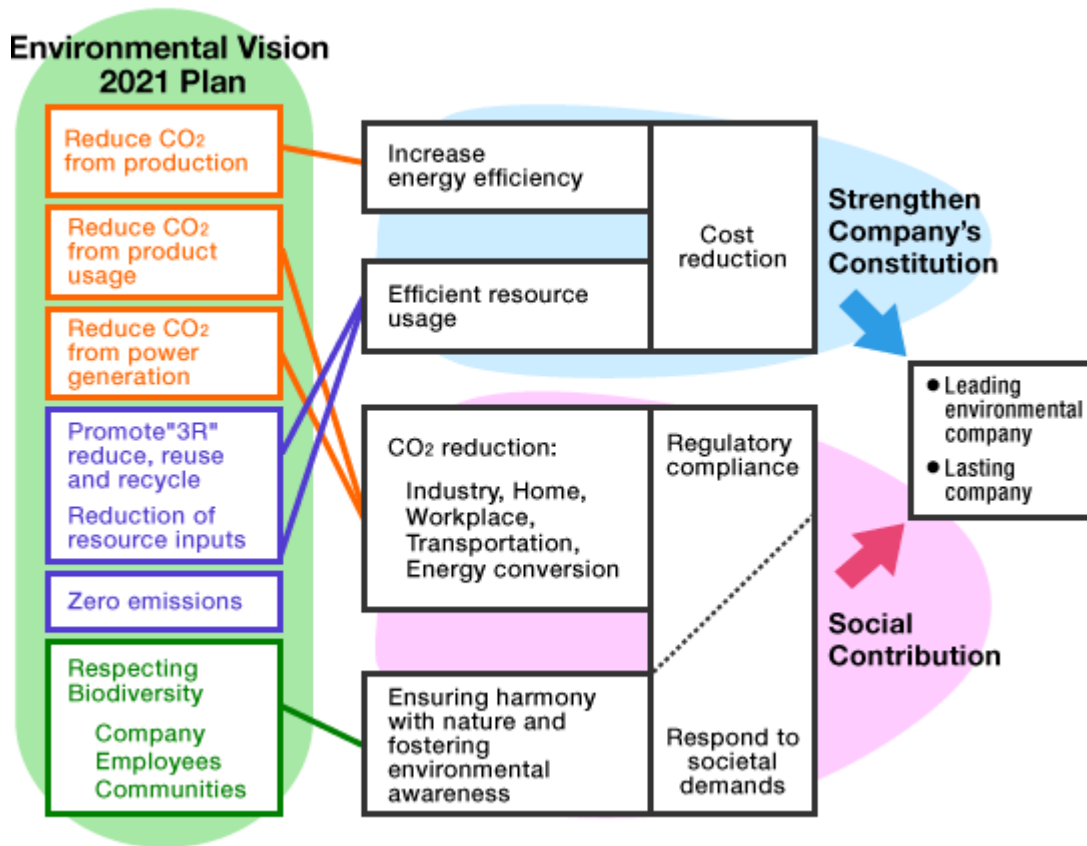

6th Environmental Plan (Fiscal 2010–2012)

Background

The 6th Environmental Plan outlines the actions and objectives to be achieved during the three years from fiscal 2010 to fiscal 2012, on the way to realizing our [Environmental Vision 2021](#). After carefully reviewing the achievements and issues surrounding the 5th Environmental Plan (fiscal 2007 to fiscal 2009), as well as the changes in the social environment, we formulated three areas of focus and identified three points of emphasis.

Focus of the 6th Environmental Plan

Establish targets and action plan for environmental performance to realize Environmental Vision 2021	Respond to social changes and imperatives surrounding environmental issues	Contribute to the creation of a sustainable society through the expansion of environment-related business
--	--	---

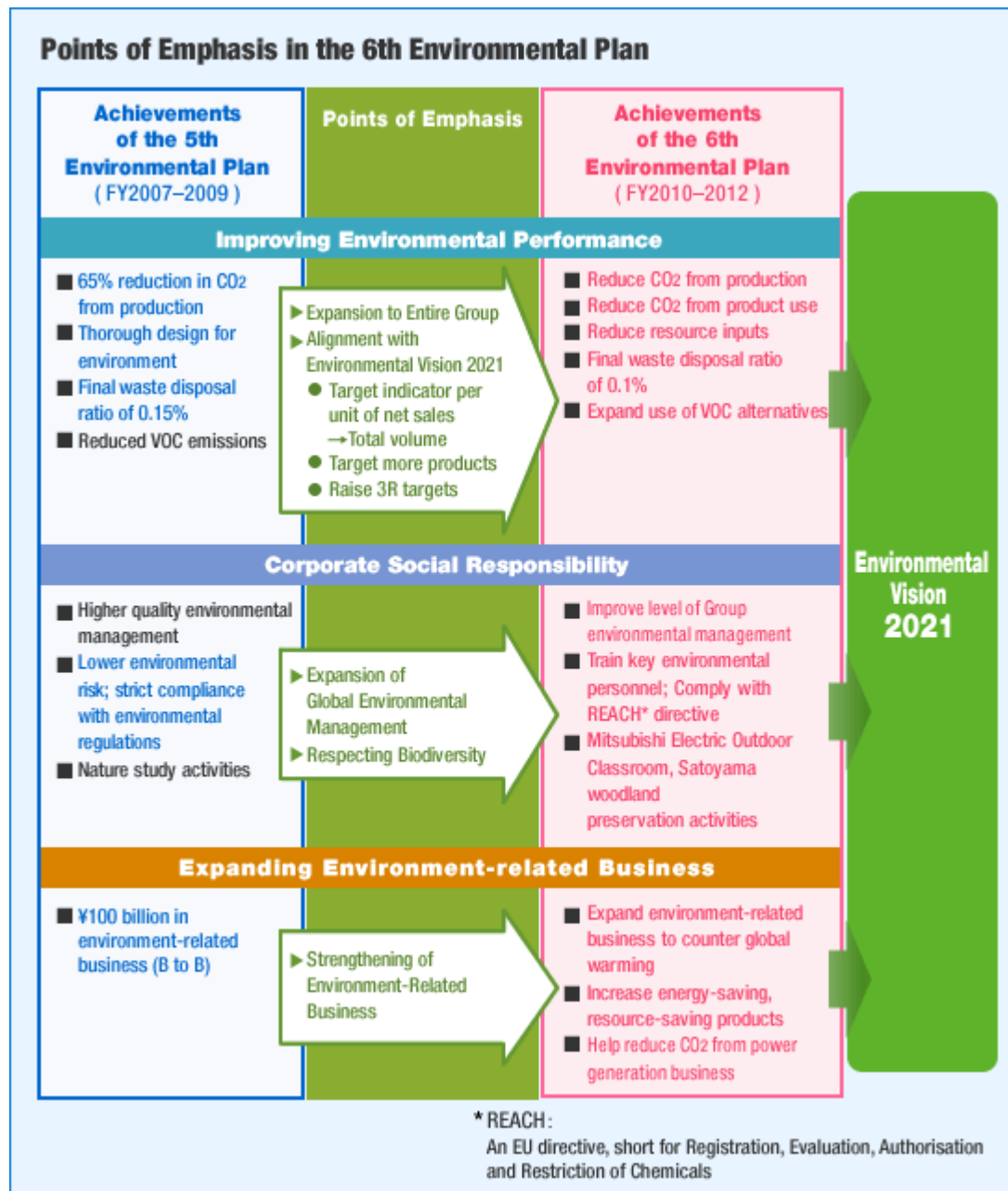

[Click here for more details](#)

Plans to Reduce CO2 from Production under Environmental Vision 2021 (Non-consolidated)

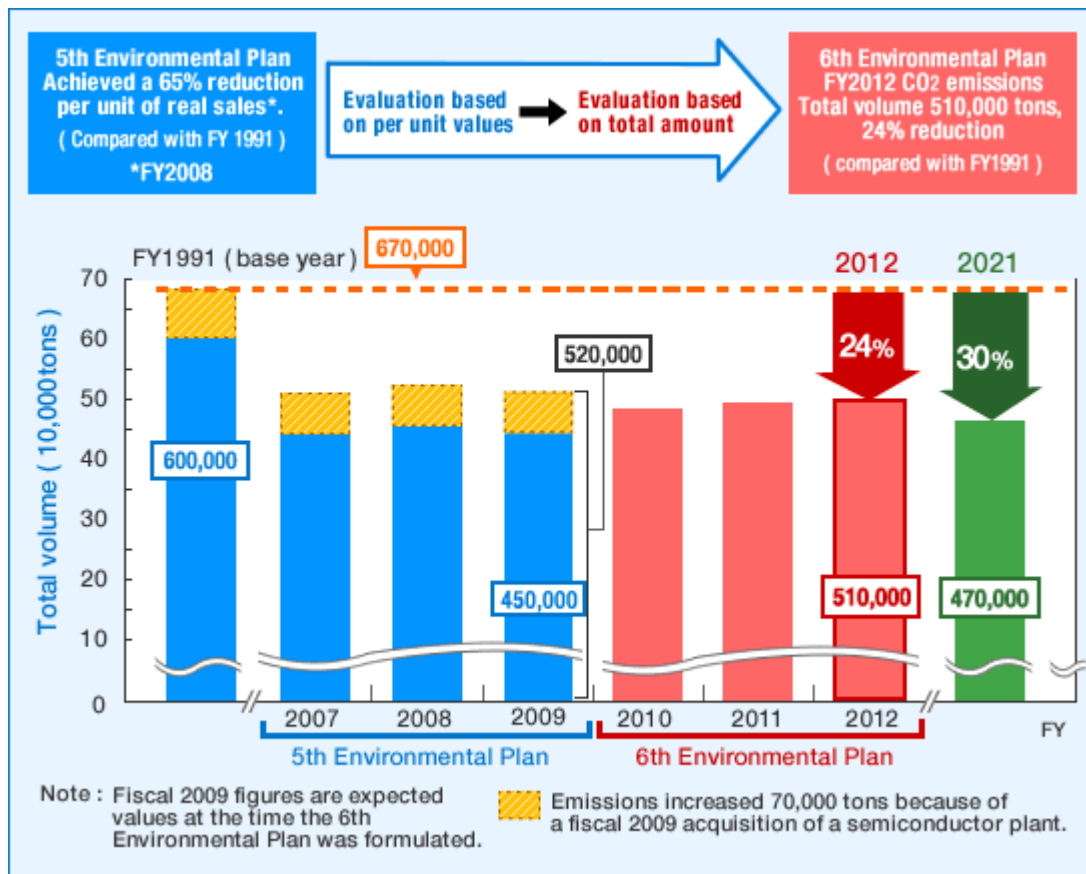

Accelerated CO2 Reduction through Expansion of Production Line Improvements

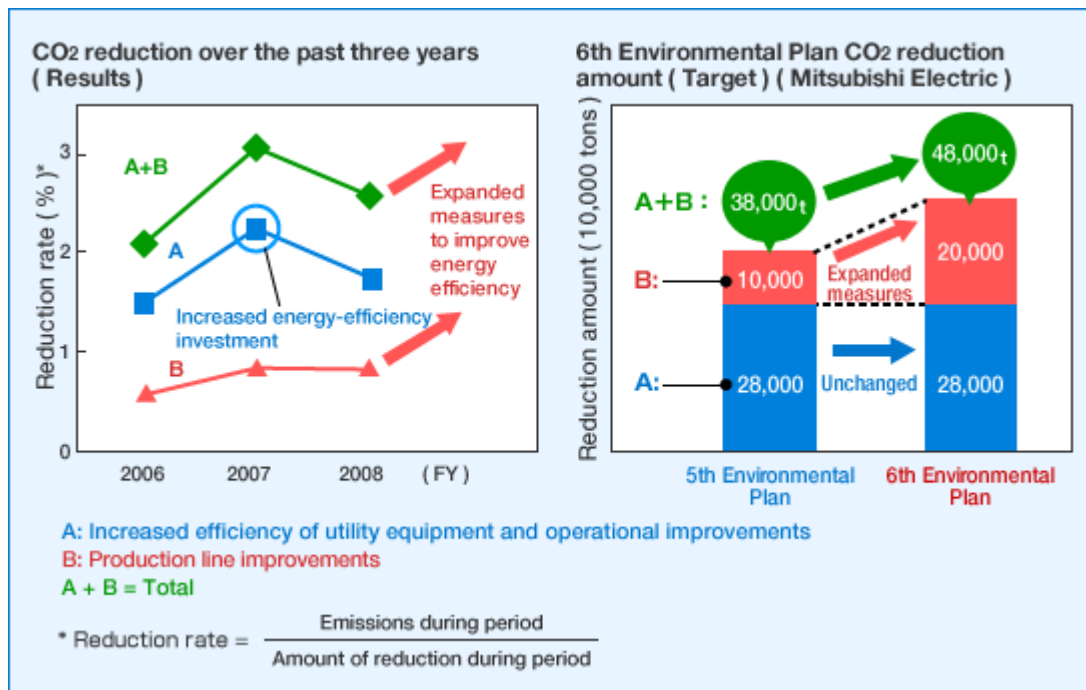

CO2 Reductions from Production Line Improvements

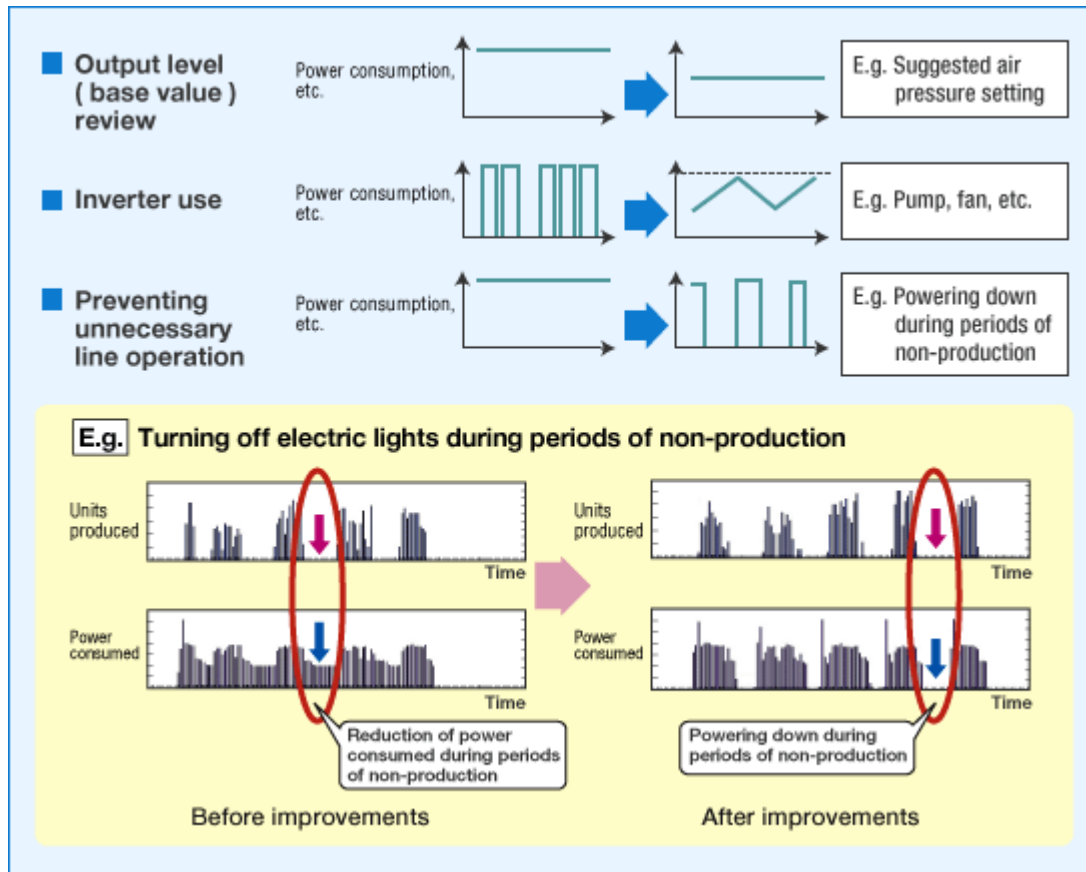

Plans to Reduce CO2 from Production Under Environmental Vision 2021 (Affiliates in Japan and overseas)

Promote CO2 reductions among affiliates in Japan and overseas based on the same ideas as Mitsubishi Electric Corporation

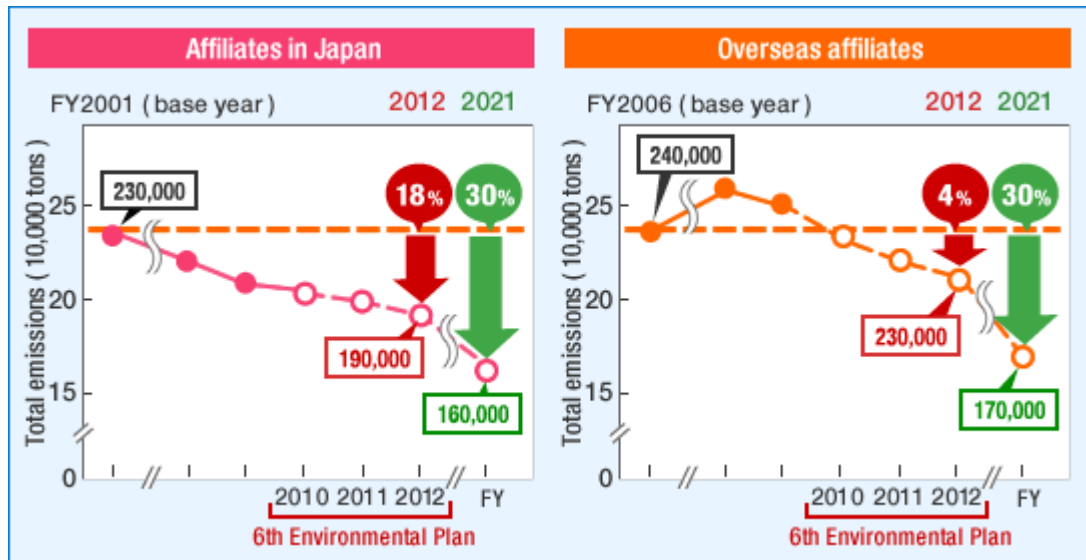

Group-wide Plan to Reduce CO2 from Production

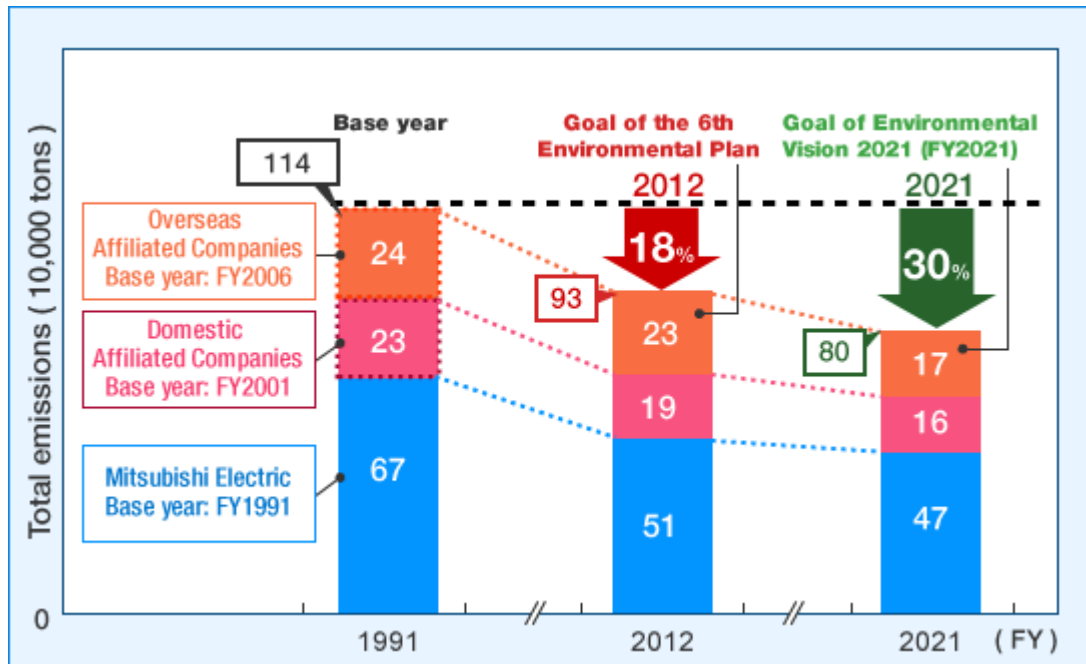

Reducing CO2 from Product Usage through Eco-Technology

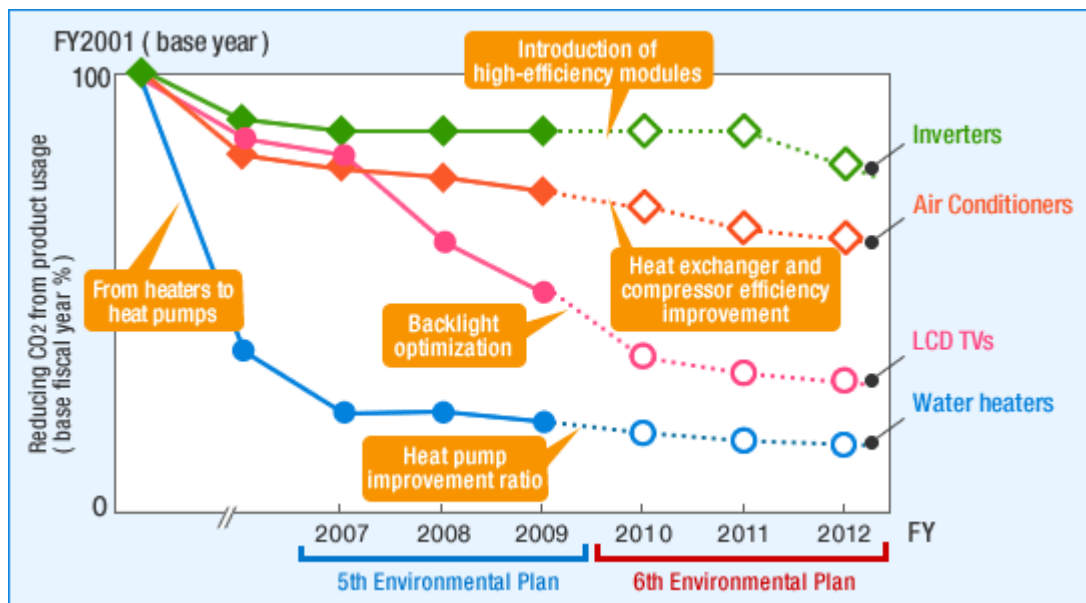

Plans to Reduce CO2 from Product Usage under Environmental Vision 2021

Aiming to achieve a 25% average reduction in CO2 from product usage in fiscal 2012 through performance improvements.

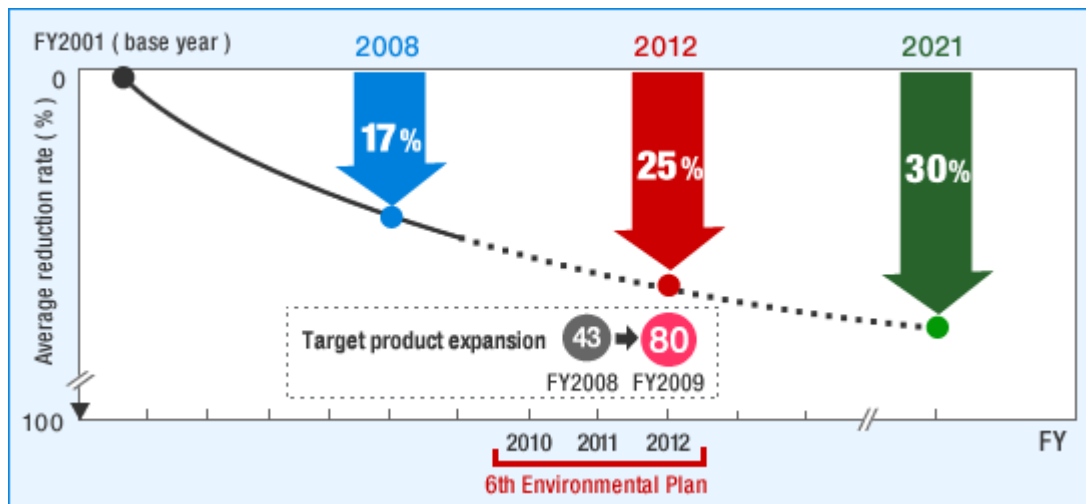

Reduction of Resource Inputs under Environmental Vision 2021

Aiming to achieve an 18% average reduction in total weight of products in fiscal 2012 through size and weight reductions

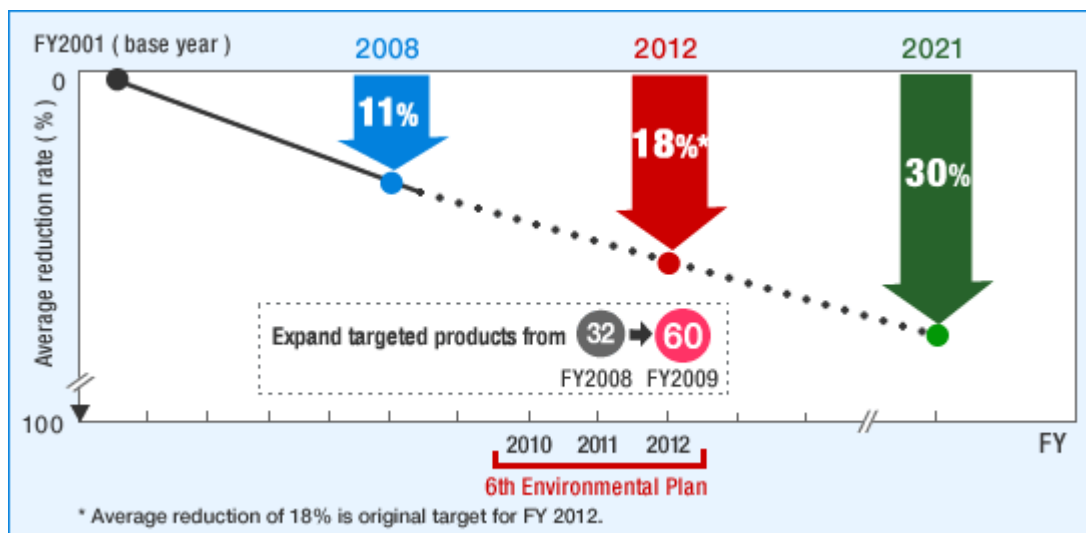

Reduction of virgin resource inputs through **large-scale, high-purity closed-loop recycling of plastics**

Large-scale

- Started up recycled materials factory
- Closed-loop recycling: expansion from 600 tons to 7,000 tons per year

High-purity

- Separates three types of plastic (Poly-Propylene, Poly-Styrene, Acrylonitrile-Butadiene-Styrene) from shredded mixed plastic
- Recovers high-purity (more than 99%) recycled plastic

Closed-loop

- Makes up approximately 18% of the plastic used in our home electronics products

Lowering the Final Waste Disposal Ratio in Pursuit of Zero Emissions

Aiming for a final waste disposal ratio of less than 0.1% at all Group sites

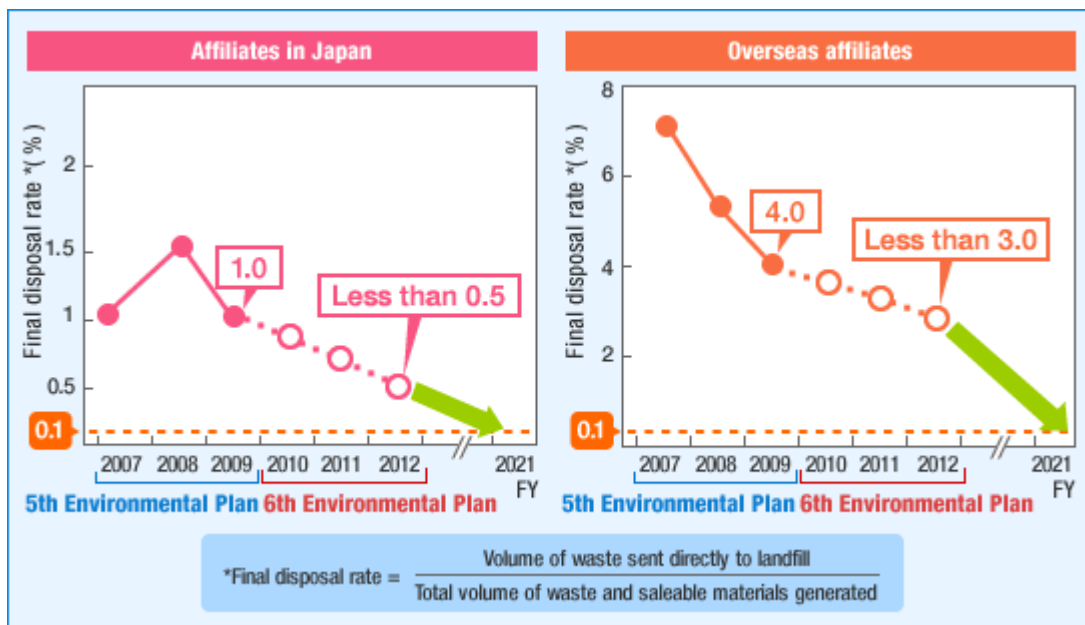
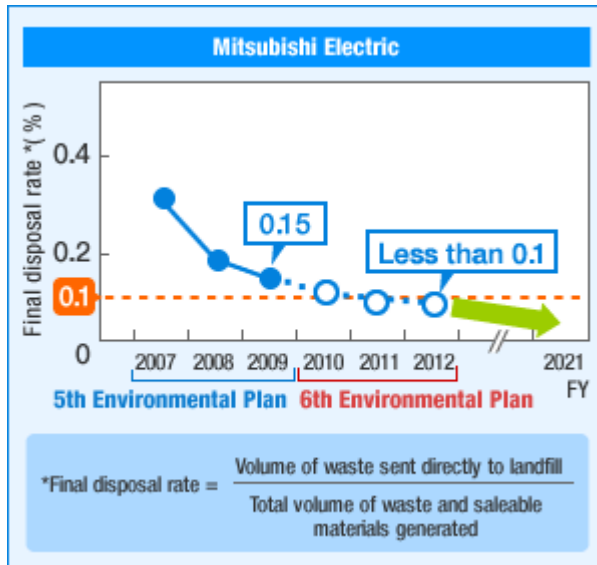

Reducing VOC Emissions through Expanded Use of Alternative Materials

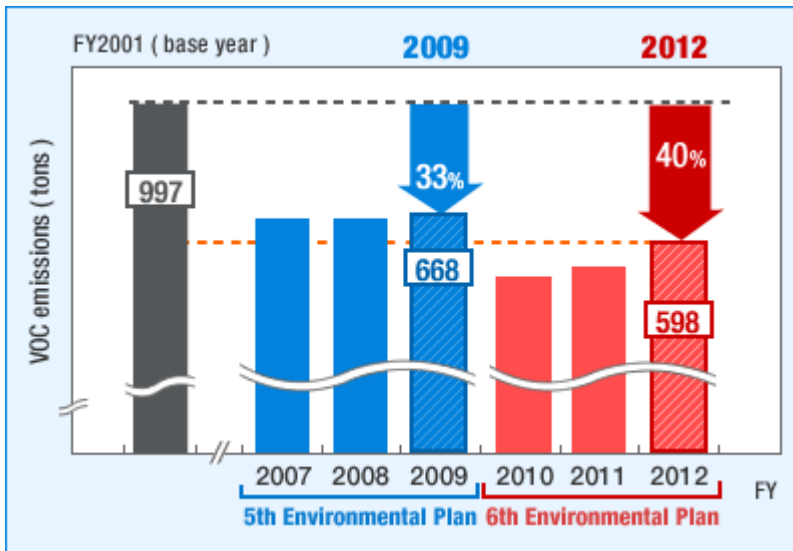

- Targeting 40% reduction by fiscal 2012
- Examples of alternative material applications
 - Switching to water-based paint
 - Switching to powdered paint
 - Switching to low-volatility solvents
 - Alternatives to metal plating

Improving Level of Environmental Management as a Group Company

Increasing the number of companies compliant with ISO 14001

Mitsubishi Electric: Obtained certification at all bases

Affiliates in Japan : Increase number of compliant companies from 77 to **99**

Overseas affiliates : Increase number of compliant companies from 36 to **64**

Assigning and Training of Key Environmental Personnel at Overseas Sites

Sites in Japan

We are currently conducting skill enhancement training for key environmental personnel assigned to each factory



Overseas Sites

We are planning to assign key environmental personnel in China, Asia, Europe and the United States, and conduct training activities



Reducing CO2 through Expansion of Environment-related Business

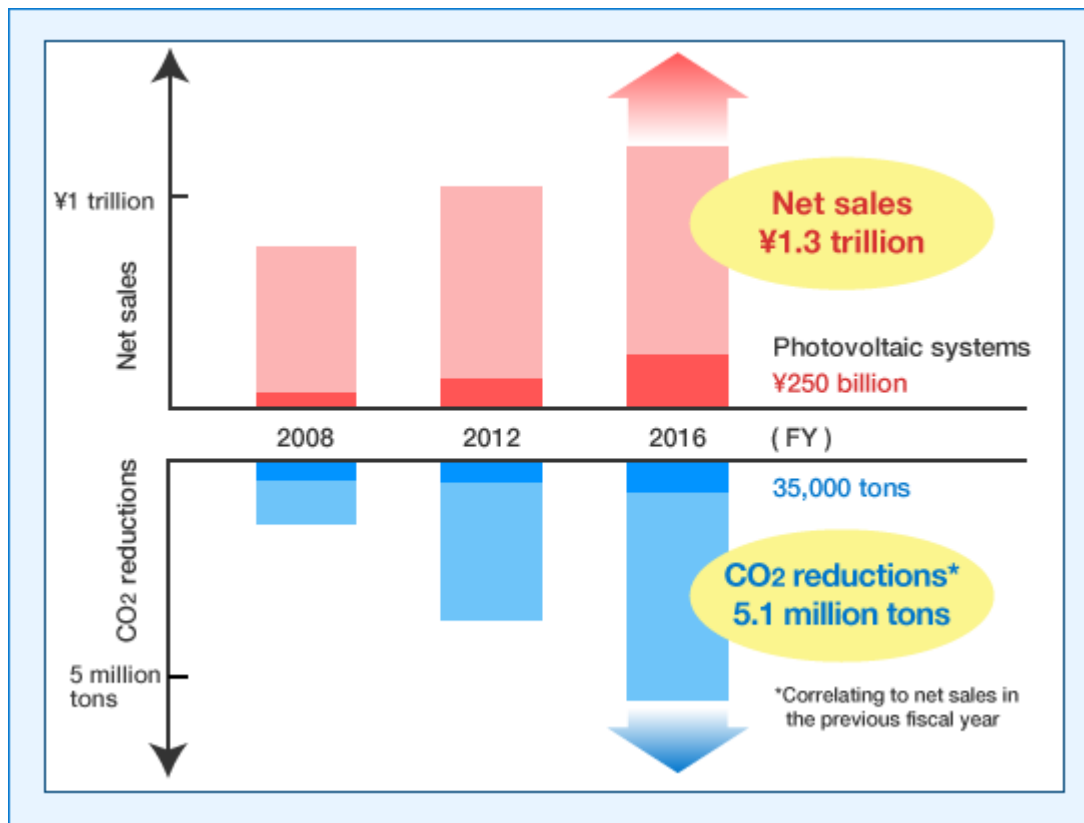

Product Lines for Expansion of Environment-related Business

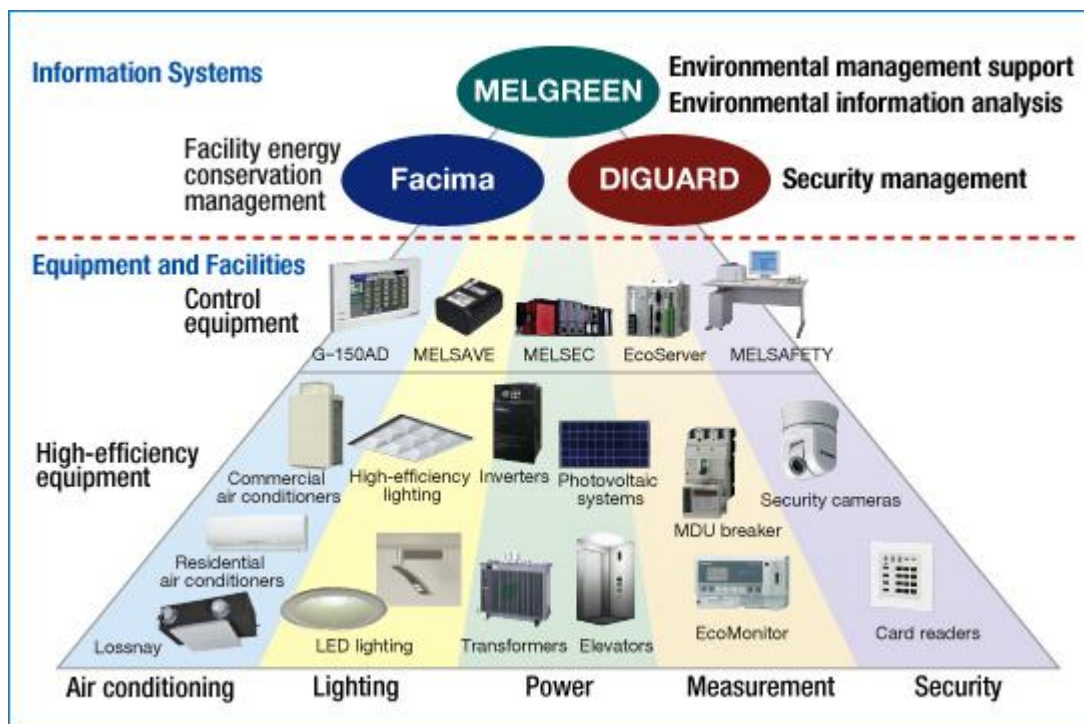

Nuclear power generation



Combined-cycle thermal power generation



Hydroelectric power generation

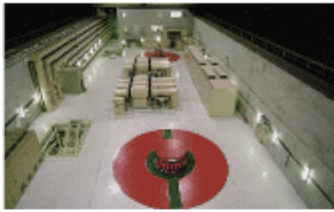

Photovoltaic power generation



Home use



Commercial use



Large-scale power generation equipment



**Reduce approximately
90 million tons of CO₂ (FY 2021*)**

*Fiscal 2021 reduction amount based on equipment delivered after fiscal 2001

6th Environmental Plan Details

Activities	Fiscal 2012 Targets		
Creating a low-carbon society			
(1) Reduce CO ₂ from production		[CO ₂ emissions]	[Required reduction amount]
	Mitsubishi Electric	510,000 tons	48,000 tons
	Affiliates in Japan	190,000 tons	21,000 tons
	Overseas affiliates	230,000 tons	26,000 tons
(2) Reduce CO ₂ from product usage	Average reduction rate by target products	25% (compared to base year FY2001)	
	Expand number of target products	43 products → 80 products	
Creating a recycling-based society			
(1) Reduce resource inputs	Average reduction rate by target products	18% (compared to base year FY2001)	
	Expand number of target products	32 products → 60 products	
(2) Zero emissions	Mitsubishi Electric	Final disposal rate of less than 0.1%	
	Affiliates in Japan	Final disposal ratio of less than 0.5%	
	Overseas affiliates	Final disposal ratio of less than 3.0%	
(3) Reduce the use of disposable packaging materials (eco-logistics)	Mitsubishi Electric	10% reduction per shipment (base year FY2009)	
	Affiliates in Japan	10% reduction per shipment (base year FY2009)	
	Overseas affiliates	Assessment of the amount of packaging materials used and product shipment	
(4) Reduce emissions of volatile organic compounds (VOCs) into the atmosphere	Mitsubishi Electric	40% reduction (from FY2001 levels)	
Expanding global environmental management			
(1) Increase the number of companies conforming with ISO 14001	Affiliates in Japan	77 companies certified → expand to 99 companies	
	Overseas affiliates	36 companies certified → expand to 64 companies	
(2) Strict compliance with environmental regulations	Ensure compliance with European REACH Regulation and individual countries' RoHS Legislation		
(3) Assign and train key environmental personnel	Assign and train key environmental personnel at factories in China, Asia, Europe and America		
Expansion of environment-related business			
(1) Environment-related business	Aim for sales of more than 1.3 trillion in Q1, FY2016		
(2) Help reduce CO ₂ from the power generation business	Increase highly efficient power generation equipment and clean energy generation facilities. Projected effects: Approximately 90 millions ton reduction in CO ₂ emissions (first quarter, fiscal 2021) (Amount of reduction by fiscal 2021 of equipment		

		delivered since fiscal 2001)
Respecting biodiversity		
Forest development/"Satoyama" Woodland Preservation Project	Expand by one region each year	
Mitsubishi Electric Outdoor Classroom	Increase by five areas each year	
	Outdoor classroom leaders	Train 50 people each year

Evolution of the Environmental Plan (1st through 5th)

Approximately every three years since fiscal 1994, the Mitsubishi Electric Group has formulated an environmental plan with specific targets. We have made many positive changes in the 15 years since the first plan went into action.

The 6th Environmental Plan (fiscal 2010-2012) was announced in October 2007 as a further step toward the realization of Environmental Vision 2021. Specific objectives were established after a careful review of accomplishments and issues stemming from the 5th Environmental Plan (fiscal 2007-2009) from the perspective of achieving the vision.

Aiming to Achieve Environmental Vision 2021

Main Points of Previous Environmental Plans	
Environmental Plan	Main Point(s)
1st Environmental Plan (FY1994–1996)	Environmental measures at factories
2nd Environmental Plan (FY1997–2000)	Introduction of ISO14001, product-related environmental measures
3rd Environmental Plan (FY2001–2003)	Reinforcing the management base, thorough compliance, disclosure of environmental information
4th Environmental Plan (FY2004–2006)	Conducting initiatives to integrate environmental considerations into all corporate activities, beyond factories and products, expand the scope of corporate information disclosure and assessment, reinforce legal compliance and discover and prevent potential risks
5th Environmental Plan (FY2007–2009)	Taking ISO14001 (FY2005 version) as an opportunity to strengthen environmental management (synergies between defensive/proactive activities)

Environmental Report









Targets & Achievements of the 6th Environmental Plan

Targets and Achievements of the 6th Environmental Plan (Fiscal 2010–2012)



[Click here for an overview of fiscal 2010 activities](#)

 Very good
  Good
  Almost there
  More effort needed

Creating a Low-carbon Society



Reducing CO ₂ from Production						
6th Environmental Plan (Fiscal 2010–2012)		Fiscal 2010			Fiscal 2011	
		Target	Target	Results	Degree of achievement Self-evaluation	Target
CO ₂ emissions	Mitsubishi Electric	510,000 tons	500,000 tons	472,000 tons		493,000 tons
	Affiliates in Japan	190,000 tons	171,000 tons	166,000 tons		165,000 tons
	Overseas affiliates	230,000 tons	238,000 tons	217,000 tons		215,000 tons
	Total	930,000 tons	909,000 tons	855,000 tons		873,000 tons
Required reduction amount (three years)	Mitsubishi Electric	48,000 tons	16,000 tons	19,000 tons		16,000 tons
	Affiliates in Japan	21,000 tons	7,000 tons	7,000 tons		7,000 tons
	Overseas affiliates	26,000 tons	9,000 tons	8,000 tons		10,000 tons
	Total	95,000 tons	32,000 tons	34,000 tons		33,000 tons

Environmental Report: Reducing CO₂ from Production



Reducing CO ₂ from Product Usage				
6th Environmental Plan (Fiscal 2010–2012) [Fiscal 2012 Targets]		Fiscal 2010		Fiscal 2011
		Achievements	Self-Assessment of Progress	Target
Average Reduction Rate for Target Products	25% (Base year: Fiscal 2001)	23%		24%
Expansion of Target Products	43 Products → 80 Products	70 Products		75 Products

Environmental Report: Reducing CO₂ from Product Usage 



Creating a Recycling-based Society

Reducing Resource Inputs				
6th Environmental Plan (Fiscal 2010–2012) [Fiscal 2012 Targets]		Fiscal 2010		Fiscal 2011
		Results	Self Assessment of Progress	Target
Average Reduction Rate for Target Products	18%	34%		30%
Expansion of Target Products	32 Products → 60 Products	51 Products		60 Products

Environmental Report: Reducing Resource Inputs 

Zero Emissions				
6th Environmental Plan (Fiscal 2010–2012) Fiscal 2012 Targets		Fiscal 2010		
		Results	Degree of achievement Self-assessment	
Mitsubishi Electric	Final disposal ratio of less than 0.1%	0.04%		
Affiliates in Japan	Final disposal ratio of less than 0.5%	0.2%		
Overseas affiliates	Final disposal ratio of less than 3.0%	3.6%		

Environmental Report: Zero Emissions 



Reducing the use of disposable packaging materials			
6th Environmental Plan (Fiscal 2010–2012) Fiscal 2012 Targets		Fiscal 2010	
		Results	Degree of achievement Self-assessment
Mitsubishi Electric	10% reduction per volume of shipment (base year Fiscal 2009)	3.3%	
Affiliates in Japan	10% reduction per volume of shipment (base year Fiscal 2009)	(4.6%)	
Overseas affiliates	Assessment of packaging material volume and product shipment volume	Completed assessment of packaging material volume in 22 companies and product shipment volume in 19 companies	

Environmental Report: Reducing the Use of Disposable Packaging Materials 

Reducing VOC Emissions				
6th Environmental Plan (Fiscal 2010–2012) Fiscal 2012 Targets	Fiscal 2010			Fiscal 2011
	Emissions target	Results	Degree of achievement Self-assessment	Target
40% reduction (base year Fiscal 2001) Emissions: 598 tons	Emissions: 535 tons	Emissions: 498 tons		Emissions: 528 tons

Environmental Report: Reducing VOC Emissions 

Expanding Global Environmental Management

Increase number of companies conforming with ISO 14001					
6th Environmental Plan (Fiscal 2010–2012) [Fiscal 2012 Targets]		Fiscal 2010			Fiscal 2011
		Targets	Achievements	Self-evaluation	Targets
Affiliates in Japan	Increase number of conforming from 77* to 99	Mitsubishi Electric investigated the ISO 14001 conformity status of 15 among the 22 noncertified companies. We assisted 7 companies in acquiring third party certification.	Mitsubishi Electric confirmed the ISO 14001 conformity of 15 among the 22 noncertified companies. We assisted 7 companies in acquiring third party certification and confirmed the certification of 2.		Assist 5 companies in acquiring third party certification.
Overseas Affiliates	Increase number of conforming from 36* to 64	Mitsubishi Electric investigated the ISO 14001 conformity status of 28 noncertified companies.	Mitsubishi Electric confirmed the ISO 14001 conformity of 17 among 28 noncertified companies.		Confirm the ISO 14001 conformity of 11 companies.

* About the figures: When the 6th Environmental Plan was announced, 63 affiliates in Japan and 31 overseas affiliates had acquired certification. Since then we have been modifying these numbers based on the fluctuation in the number of affiliate companies and on investigation results of scope of environmental management systems for each company.

[Environmental Report: Expanding ISO 14001 Conformity](#) 

Complying with environmental regulations

6th Environmental Plan (Fiscal 2010–2012) [Annual Targets]	Ensure compliance with European REACH regulations and individual countries' RoHS directives
---	---

[Environmental Report: Complying with Environmental Regulation](#) 

Assigning and Training Key Environmental Personnel

Targets of the 6th Environmental Plan (Fiscal 2010–2012)	Assign and train key environmental personnel at factories in China, Asia, Europe, and America
--	---

[Environmental Report: Training Key Environmental Personnel](#) 

Expanding Environment-related Business

Environment-Related Business

6th Environmental Plan (Fiscal 2010–2012) [Fiscal 2016 Targets]	Aiming to Achieve ¥1.3 Trillion in Net Sales in Fiscal 2016
--	---

[Environmental Report: Environment-Related Business](#)

Help reduce CO₂ from the power generation business

6th Environmental Plan (Fiscal 2010–2012) [Fiscal 2021 Target]	Increase highly efficient power generation equipment and clean energy generation facilities Projected effects: Reduction in CO ₂ emissions of approximately 90 million tons (Q1, Fiscal 2021) (Amount of reduction by fiscal 2021 of equipment delivered since Fiscal 2001)
---	--

[Environmental Report: Reducing CO₂ from Power Generation](#)

Respecting Biodiversity

Forest Cultivation and "Satoyama" Woodland Preservation				
6th Environmental Plan (Fiscal 2010–2012) Targets by fiscal year	Fiscal 2010			Fiscal 2011
	Target	Results	Degree of achievement Self-assessment	Target
Expand by one or more regions per year	Held in one new region, for total of five regions	Implemented according to plan		Held in one new region, for total of six regions

Environmental Report: Fostering Environmental Awareness 

Mitsubishi Electric Outdoor Classroom				
6th Environmental Plan (Fiscal 2010–2012) Targets by fiscal year	Fiscal 2010			Fiscal 2011
	Target	Results	Degree of achievement Self-assessment	Target
Increase by five regions per year Train 50 outdoor classroom leaders per year	Held in 5 new regions, for total of 26 times in 15 regions	Held in 9 new regions, for total of 30 times in 19 regions Trained 46 outdoor classroom leaders		Held in 5 new regions, for total of 35 times in 24 regions

Environmental Report: Fostering Environmental Awareness 

Overview of Fiscal 2010 Activities

The 6th Environmental Plan (Fiscal 2010–2012) addresses three areas: (1) improving environmental performance; (2) corporate social responsibility (expanding global environmental management and respecting biodiversity); and (3) expanding environment-related business.

Improving Environmental Performance

With regard to environmental performance, we took Group-wide measures aimed at the creation of a low-carbon, recycling-based society.

On the particularly vital issue of reducing CO₂ from production, we made concrete progress toward bolstering production line improvements, as laid out in the 6th Environmental Plan. We cut CO₂ emissions by 34,000 tons across the Group in fiscal 2010, marking a steady step toward our goal of a 95,000-ton reduction over the three years of the Plan.

Regarding initiatives aimed at creating a recycling-based society, our "zero emissions" activities at Mitsubishi Electric and at our affiliates in Japan resulted in our meeting final disposal ratio targets for fiscal 2012 well ahead of schedule. At the same time, we made strides toward the fiscal 2011 launch of Japan's first large-scale, high-purity plastic recycling plant.

In product-centered initiatives, we expanded the number of products targeted for 30% reduction in CO₂ emissions from product usage, and the number of target products for reducing resource inputs, as set out in Environmental Vision 2021. For target products in each category, we succeeded in improving the average reduction amounts.

Corporate Social Responsibility

- **Expanding global environmental management**

We are working to set a uniform high level of quality in environmental management in all of the consolidated subsidiaries and affiliated companies under the Mitsubishi Electric Group management umbrella. To that end, in fiscal 2010 we established a framework to promote a "Self Compliance" status recognized by Mitsubishi Electric as conforming to ISO 14001, at the non-production sites and the small-scale affiliated production sites that have not previously been subject to ISO 14001 certification.

- **Respecting biodiversity**

We have long been engaged in environmental activities aimed at creating a low-carbon, recycling-based society. To bolster that vision with new perspectives on biodiversity, we established the Mitsubishi Electric Group Biodiversity Action Guidelines. Under these guidelines, we will take biodiversity into consideration in all of our business activities, contributing to the development of a sustainable society. At the same time we will expand initiatives that foster environmental awareness, such as our forest cultivation / "Satoyama" woodland preservation project and the Mitsubishi Electric Outdoor Classroom.

Expanding Environment-related Business

In June of 2010 the Mitsubishi Electric Group began global rollout of its "Eco Changes" environmental statement, expressing our intent to create a greener tomorrow together with our customers and society, through high-level technology and wide-ranging business.

We have also set environment-related business as one of the pillars of growth for the Mitsubishi Electric Group. In particular, we have set goals and embarked upon initiatives in the fields of photovoltaic systems, heat pumps, power devices, and electrical supply.

Environmental Report

Environmental Management



▶ Aiming to Achieve Environmental Vision 2021

Advancing environmental management to achieve the high goals we have set for the future.

▶ Expanding Global Environmental Management

An overview of the systems to advance environmental management within the entire Mitsubishi Electric Group.

▶ Expanding ISO 14001 Conformity

Expanding certification and "self-declaration of conformance" to further raise the level of our environmental management.

▶ Complying with Environmental Regulations

Efforts towards Compliance
Environmental Risk Management

▶ Environmental Audits

Overview of our multifaceted auditing system combining internal environmental audits, third-party compliance assessments, and audits by the head office.

▶ Environmental Education

Examples of initiatives and programs aimed at environmental education within the entire Mitsubishi Electric Group.

▶ Training Key Environmental Personnel

Overview of the educational system for training "key environmental personnel" to shoulder environmental management affairs within factories.

▶ Environmental Communication

Examples of conversations with stakeholders and dissemination of information through multiple opportunities and media.

Aiming to Achieve Environmental Vision 2021

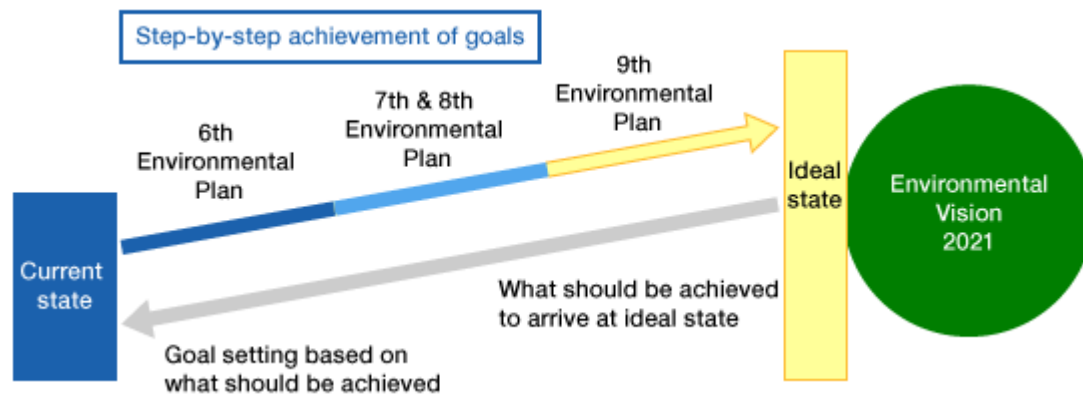

The Mitsubishi Electric Group conducts environmental management under an annual Environmental Implementation Plan, which in turn follows a broader Environmental Plan formulated every three years. Through a cycle of scrutinizing and summarizing achievements each year and reflecting those results in plans for the next year, the Group steadily achieves the goals of the Environmental Plan.

In addition, we recognize the need to establish clear and long-term goals for environmental management in response to today's calls for sustained efforts toward resolving environmental issues. In October 2007, we released our long-term vision, "Environmental Vision 2021," with its target year of 2021 marking the 100th year since the company's establishment. We have incorporated its content into environmental planning starting with our 6th Environmental Plan (fiscal 2010–2012), asking ourselves what measures we need to take to achieve our ideal vision.

- [Environmental Report: Environmental Vision 2021](#)
- [Environmental Report: Evolution of the Environmental Plan](#)
- [Environmental Report: 6th Environmental Plan \(Fiscal 2010 - 2012\)](#)

Environmental Management

Expanding Global Environmental Management

In order to fulfill its responsibilities as a corporate group carrying out business globally, the Mitsubishi Electric Group aims in its 6th Environmental Plan (fiscal 2010–2012) to establish and continuously improve a uniformly high level of quality in environmental management across all organizations within the Group.

Environmental Governance

Environmental management and environmental governance are key links in the business management of the Mitsubishi Electric Group, and are applicable to the company, its consolidated subsidiaries, and its affiliated companies (Mitsubishi Electric, and 163 affiliated companies in Japan and overseas, as of March 2009).

All levels of the organization—from head office management divisions to management and business groups, workplaces, and affiliated companies—work within the scope of their management responsibilities to oversee the environmental performance and the status of environmental management execution within their downstream organizations, leading the way for the Group as a whole.

The environmental management promotion structure is an integral part of the corporate body, and accordingly receives the participation of all employees within applicable organizations.

Management Structure

A full-participation environmental management promotion structure integrated with the corporate organization

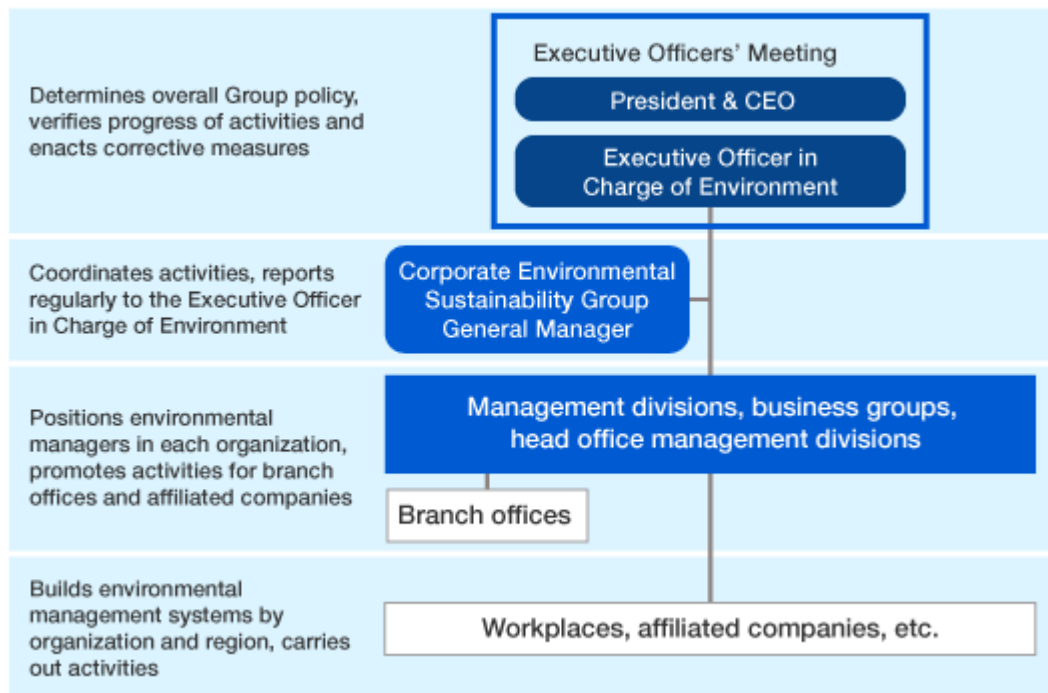

The Mitsubishi Electric Group has established a full-participation environmental management promotion structure integrated with the corporate organization. This structure is the responsibility of the Executive Officer in Charge of Environment and is assisted by the General Manager of the Corporate Environmental Sustainability Group, all under the Executive Officers' Meeting chaired by the President. The structure places environmental managers within all business groups, management divisions, branches, business units, works, and affiliated companies, to establish and operate environmental management systems (EMS) at the corporate organization and regional level, promoting environmental activities throughout the Group.

Group Operation of Environmental Management Systems (EMS)

Integrated operation of management systems around the shared goal of the Environmental Plan

In its 5th Environmental Plan (fiscal 2007–2009), the Mitsubishi Electric Group established a structure aimed at the group-wide integrated operation of Environmental Management Systems (EMS), launching operations from fiscal 2009.

Environmental management, an aspect of business management based on the Mitsubishi Electric Group Environmental Policy, is executed according to the requirements of the international standard ISO 14001. Each organization takes the achievement targets for the year from the Environmental Plan (currently the 6th Environmental Plan) and sets those as its environmental goals. In this way, environmental management vectors are aligned and the EMS of the Mitsubishi Electric Group is implemented in integrated fashion, while specific environmental targets and implementation plans are set by each organization.

Integrated Operation		
Integration		
Head office, branch offices	【 Environmental goals 】 6th Environmental Plan	Environmental targets ----- Implementation plan
Works (EMS organizations)	【 Environmental goals 】 6th Environmental Plan	Environmental targets ----- Implementation plan
Factories (EMS organizations)	【 Environmental goals 】 6th Environmental Plan	Environmental targets ----- Implementation plan
R&D centers (EMS organizations)	【 Environmental goals 】 6th Environmental Plan	Environmental targets ----- Implementation plan
Affiliates in Japan (EMS organizations)	【 Environmental goals 】 6th Environmental Plan	Environmental targets ----- Implementation plan
Overseas affiliates (EMS organizations)	【 Environmental goals 】 6th Environmental Plan	Environmental targets ----- Implementation plan

Multi-faceted monitoring of activities with three types of environmental audits and on-site inspections

■ In Japan

To ascertain the operational status of Environmental Management Systems (EMS) and compliance with environment-related legislation at sites in Japan, we carry out three types of audits: internal environmental audits conducted by works, R&D centers, and affiliated companies; management system evaluation conducted by certification bodies based on ISO 14001; and environmental audits led by the head office to verify legal compliance and progress on the Environmental Plan of the Mitsubishi Electric Group.

■ Outside Japan

Primarily targeting production sites, we use a shared global checklist to conduct on-site environmental inspections from a risk management perspective, and discuss ways to resolve issues.

Environmental Report: Environmental Audits

Activity Flow (Management Cycle)

Continual verification of activity results



Setting a cycle (management cycle) of one year, the flow of our environmental activities is as follows:

(1) Fiscal year planning

(2) Environmental implementation planning

This plan determines the achievement targets and action plan for the fiscal year, based on the Environmental Plan

(3) First-Half Managers' Conference (Companywide Environmental Managers' Conference)

At this conference, environmental managers from all Group companies confirm and familiarize themselves with information and policies on particularly vital themes.

(4) Confirmation of half-year progress and achievements

The Corporate Environmental Sustainability Group collects data on topics such as environmental performance, and reports to the Executive Officer in Charge of Environment. The Executive Officer conducts reviews and revisions of plans as required, such as in the case of major changes in the work environment of the Group overall.

(5) Second-Half Managers' Conference (Companywide Environmental Managers' Conference)

At this conference, environmental managers from all Group companies make progress reports and recommend directions to consider in planning for the next fiscal year.

(6) Annual environmental results report

The Corporate Environmental Sustainability Group collects data on environmental performance for the fiscal year and reports to the Executive Officer in Charge of Environment.

(7) Management review

The Executive Officer in Charge of Environment reviews activity results, revising the Environmental Plan and Environmental Implementation Plan for the next fiscal year as necessary.

Repeating the cycle of planning (or revision in the second half), implementation, inspection of results, and revision every half year, we improve the level of our activities. In addition, we conduct on-the-spot audits and inspections to verify that appropriate actions are being performed.

Information Sharing in Conferences

Sharing information in conferences to improve overall management level

In addition to issue-specific technical committees and EMS Organization Managers' Conferences, the Mitsubishi Electric Group holds conferences in Japan and overseas, bringing together environmental managers from all divisions. These sessions help to regularly and continuously share useful information, including best practices and cautionary items taken from division activities, while confirming key points that require coordination. The conferences play a vital role in improving the overall level of management.

■ In Japan

Once per fiscal half, relevant managers from all company sites and affiliates in Japan gather at the Companywide Environmental Managers' Conference, where managers share information, the Executive Officer in Charge of Environment provides updates on policies, and all divisions report on the progress of initiatives.

■ Outside Japan

Overseas Regional Environmental Conferences are held once per year in the U.S., Europe, China, and Asia. Convened by the Corporate Environmental Sustainability Group, the conferences gather the environment managers from overseas affiliates along with participants from the business groups and mother factories in Japan. The meetings strengthen the coordination of overseas affiliates with each other and with the head office, raising environmental management levels at each site.

Complying with International Environmental Regulations

Complying with Environmental Regulations

As local entities enact strict compliance with the various laws and regulations of their respective country or region, the head office employs corrective measures based on self-audits and inspections to ensure legal compliance with international regulations that need to be addressed by the Group as a whole, such as RoHS or REACH.

Environmental Report: Complying with Environmental Regulations 

Training Key Environmental Personnel and Assigning them to Factories

Strict compliance with environmental regulations requires staff who are able to accurately execute the necessary management tasks. The Mitsubishi Electric Group trains and assigns key environmental personnel to undertake this work.

- **In Japan**

We assign key environmental personnel to each factory, conducting training to raise their level of education.

- **Outside Japan**

In fiscal 2011 we are assigning key environmental personnel within China, with plans to expand the program to Asia, Europe, and America.

Environmental Report: Training Key Environmental Personnel 

Fostering Environmental Awareness

Promoting Environmental Awareness at Home and Overseas

The Mitsubishi Electric Group positions the fostering of environmental awareness as a key aspect of preserving biodiversity, and conducts local activities in Japan and overseas under this directive.

- **In Japan**

We are continuing our environmental conservation activities centered around the Mitsubishi Electric Outdoor Classroom and "Satoyama" woodland preservation.

- **Outside Japan**



Activities are centered around reforestation efforts, but from fiscal 2011 our overseas programs have also begun to include Mitsubishi Electric Outdoor Classrooms.

Environmental Report: Fostering Environmental Awareness 

Expanding ISO 14001 Conformity

6th Environmental Plan (fiscal 2010–2012) Targets and Progress in Fiscal 2010

Expanding Global Environmental Management

Increase number of companies conforming with ISO 14001					
6th Environmental Plan (fiscal 2010–fiscal 2012)		Fiscal 2010			Fiscal 2011
[fiscal 2012 Targets]		Targets	Achievements	Self-evaluation	Target
Affiliates in Japan	Increase number of conforming from 77* to 99	Mitsubishi Electric investigated the ISO 14001 conformity status of 15 among the 22 noncertified companies. We assisted 7 companies in acquiring third party certification.	Mitsubishi Electric confirmed the ISO 14001 conformity of 15 among the 22 noncertified companies. We assisted 7 companies in acquiring third party certification and confirmed the certification of 2.		Assist 5 companies in acquiring third party certification.
Overseas Affiliates	Increase number of conforming from 36* to 64	Mitsubishi Electric investigated the ISO 14001 conformity status of 28 noncertified companies.	Mitsubishi Electric confirmed the ISO 14001 conformity of 17 among 28 noncertified companies.		Confirm the ISO 14001 conformity of 11 companies.

* About the figures: When the 6th Environmental Plan was announced, 63 affiliates in Japan and 31 overseas affiliates had acquired certification. Since then we have been modifying these numbers based on the fluctuation in the number of affiliate companies and on investigation results of scope of environmental management systems for each company.

Mitsubishi Electric Group Initiatives for Fiscal 2010

In order to continuously improve the level of environmental management, the Mitsubishi Electric Group has focused on acquiring ISO 14001 certification at its production sites. Mitsubishi Electric acquired certification for all its production sites by 1999, and the head office and branch locations were certified in 2004. The 6th Environmental Plan (fiscal 2010–2012) expands these initiatives to non-production sites and the small-scale production sites of affiliated companies. Efforts are being redoubled throughout the group to improve our environmental management level.

For this purpose and in addition to continuing the acquisition of ISO 14001 and Japan's Ministry of the Environment Eco-Action 21 third-party certification for each site, Mitsubishi Electric has also established a "self-declaration of conformance" system. We can use this system to confirm that the environmental management level of the site which has not yet acquired third party certification is in accordance with ISO 14001 standards.

This self-declaration of conformance is described in ISO 14001: 2004 [1. range of application c) 1] and allows businesses to determine for themselves if an Environmental Management System conforms to ISO 14001, and based on this certification mechanism they can forgo inspections by a certification body. It is imperative to bring the level of environmental management up to complete conformance with ISO 14001 standards.

In fiscal 2010, Mitsubishi Electric specified requirements and procedures for confirming self-declaration of conformance as company policy, and explained these to our affiliated companies. We then revised the environmental management check sheet that had been used to carry out internal inspections, and incorporated the applicable procedures into company policy.

In fiscal 2010 Mitsubishi Electric assisted 7 of 22 noncertified affiliates in Japan in acquiring third-party certification. Of these, two companies* acquired ISO 14001 certification for their Environmental Management System. Also, the remaining 15 companies conformed self-declaration of conformance to ISO 14001. We investigated the conformity status of 28 noncertified overseas affiliates, and confirmed the conformity of 17. We demonstrated how to make the necessary improvements to those affiliates that did not reach conformity levels.

* Mitsubishi Electric Information Network Corporation and Super Communications, Inc.

Complying with Environmental Regulations

▶ Efforts towards Compliance

Basic policies regarding compliance with environmental laws and regulations, and initiatives taken in fiscal 2010.

▶ Environmental Risk Management

Policies and initiatives related to handling of groundwater and soil contamination, prevention of environmental accidents, proper storage and treatment of PCBs, and handling of transformers with low-concentration PCBs.

Complying with Environmental Regulations

Efforts towards Compliance

Basic Policies and Initiatives Relating to Legislation in Fiscal 2010

Sharing information and continuing self-audits/inspections

Ensuring a proper response to environmental regulations that vary by country or region requires a proper understanding of the details of each regulation, such as its scope of application and any actions to revise it. The Mitsubishi Electric Group collects and shares the latest information on regulations, and takes ongoing corrective action based on self-audits and inspections.

Our main initiatives for 2010 that relate to environmental regulations were as follows.

■ **Initiatives related to REACH¹, RoHS², PRTR Law³, and the Chemical Substances Control Law⁴**

In December 2009, Mitsubishi Electric launched the Chemical Substance Information Management System to enable the collection and sharing of legally-required information on substances among our business partners. In addition, we maintained a 100% Green Accreditation rate in our evaluation of applicable business partners' management of chemical substances contained in the products they provide.

■ **Initiatives Relating to the Law Regarding the Rationalization of Energy Use and the Law Concerning the Promotion of Measures to Cope with Global Warming**

Mitsubishi Electric investigated energy usage not only at production sites but also at the head office and branch offices, and made preparations for medium- and long-term energy conservation planning and reporting.

■ **Initiatives Relating to the ErP Directive⁵**

Mitsubishi Electric complied with internationally regulated energy conservation requirements for each product group.

■ **Initiatives Relating to the Soil Contamination Countermeasures Act**

We made efforts to disseminate information on the April 1, 2010 revisions to the Act and enable a rapid response to it.

■ **Initiatives Relating to the Waste Disposal and Public Cleansing Law**

We filed opinions via industry associations in response to proposed revisions to the Law, and worked to disseminate information about planned changes in order to accommodate the revised Law.

- 1 REACH: REACH is a regulation on the Registration, Evaluation, Authorization and Restriction of Chemicals, which went into effect in the EU in 2007. The regulation mandates registration and risk evaluation for chemical substances in chemicals amounting to 1 ton or more per year that are manufactured in or imported into the EU, as well as provision of information concerning chemical substances to customers and consumers, and notification to the European Chemical Agency for articles such as electrical and electronic products that contain specific chemicals.
- 2 RoHS: This legislation, which went into effect in July 2006, limits the use of six specified substances in electrical and electronic products.
- 3 PRTR Law: Act on Confirmation, etc. of Release Amounts of Specific Chemical Substances in the Environment and Promotion of Improvements to their Management.
- 4 Chemical Substances Control Law: Act on the Evaluation of Chemical Substances and Regulation of Their Manufacture, etc.
- 5 ErP Directive: This directive, phased in from 2008, specifies energy-saving/eco-designs for products that use electricity.

Complying with Environmental Regulations

Environmental Risk Management

Handling Groundwater and Soil Contamination

Investigations and Measures Accompanying Changes in Land Use

Mitsubishi Electric's internal regulations call for investigating whether groundwater or soil contamination is present in cases such as land redevelopment, with environmental assessments and countermeasures to be conducted as required.

Based on these internal regulations, when land redevelopment or other such changes take place, we conduct assessments at company and affiliated company sites (including factories and offices) based on investigative procedures outlined by directives including the Soil Contamination Countermeasures Act, and then enact countermeasures appropriate to the contamination scenario.

In fiscal 2010 we evaluated the findings and countermeasure proposals from groundwater and soil surveys accompanying 14 cases of changes in land use (9 in Mitsubishi Electric, 5 in affiliated companies), and verified that appropriate responses were conducted in all cases.

Moreover, for the 12 districts in which groundwater or soil contamination have been found in the past, we are carrying out ongoing remediation measures according to laws and regulations while continually reporting the results of monitoring to the appropriate authorities.

Prevention of Environmental Accidents

Using 5 Why analysis to identify causes of incidents and prevent reoccurrence

To guard against incidents with severe impact on the environment (i.e., environmental accidents), the Mitsubishi Electric Group employs measures such as early replacement of aging equipment and cross-inspections among production sites.

Furthermore, in the event of environmental accident or of incidents that could lead to such, we research causes using 5 Why analysis and work toward prevention of reoccurrence by sharing the information gained. 5 Why analysis is the method of determining causes by asking "Why did this occur?" and with regard to each reason found, asking "Why did that happen?" The questioning enables discovery of the true causes behind incidents, as well as related hidden factors. Added analysis from third parties leads to further effective solutions from different viewpoints.

In fiscal 2010, four incidents occurred that carried with them the possibility of an environmental accident. By looking into causes through 5 Why analysis and working with the guidance of administrative authorities, we took corrective actions to prevent reoccurrence.

Moreover, we worked to uncover latent risks using the Environment Risk Management Guidelines drawn up by four electric and electronics industry associations*, and created a 'Why' Analysis Guide Sheet laying out the detailed procedures for implementing 5 Why analysis.

In fiscal 2011 we will strengthen our environmental patrol activities and disseminate methodologies for cause analysis using our 'Why' Analysis Guide Sheet to all production sites in Japan and overseas. The Guide Sheet will also find use in education for key environmental personnel (i.e., employees who manage environment-related equipment).

* Four electric and electronics industry associations: Japan Electronics and Information Technology Industries Association (JEITA), Communications and Information network Association of Japan (CIAJ), Japan Business Machine and Information System Industries Association (JBMA), and The Japan Electrical Manufacturers'

Appropriate Storage and Processing of PCBs

Completed processing of 264 units in fiscal 2010

At least once per year we inspect and check stored PCB waste and in-use devices that contain PCBs, at each site at which these are stored. Personnel responsible for supervising or carrying out work involving PCBs are trained to ensure that storage conditions are properly managed.

We currently dispose of PCB waste in a systematic manner on the basis of a contract signed in fiscal 2007 with the Japan Environmental Safety Corporation (a fully owned government body that conducts PCB waste disposal under government supervision).

In fiscal 2010, we completed processing of 264 units. Current plans call for the processing of 240 units during fiscal 2011, of 930 units by the end of fiscal 2012 (the last year of the 6th Environmental Plan), and the completion of processing for all 1,931 units by fiscal 2014.

Our affiliates in Japan are also moving ahead with processing in a systematic fashion.

Customers can determine whether they have any electrical devices that use PCBs and were manufactured by the Mitsubishi Electric Group by referring to a list posted on the Group website.

Handling Transformers with Low-Concentration PCBs

Undertaking proper processing at Minister of the Environment-authorized facilities from fiscal 2011

With respect to the possibility of trace amounts of PCBs contaminating transformers and other devices, Mitsubishi Electric has investigated scenarios including the possibilities of contamination during the manufacturing process, contamination after delivery, and contamination through insulating oil. However, unable to identify the causes, devices involved, or time of manufacture, our conclusion is that we cannot negate the possibility of trace PCB contamination in electrical devices that use electrical insulating oil and that were manufactured prior to 1989.

Regarding devices manufactured from 1990 onward, given the strengthening of quality control for insulating oil, we have determined that there has been no contamination by low-concentration PCBs at time of product shipment.

Together with ongoing quality control for insulating oil, we are working to provide technical information via our website, and are responding to individual inquiries via a customer service desk already in place.

Mitsubishi Electric also participates in the PCB Disposal Committee of the Japan Electrical Manufacturers' Association, cooperating with the industry group to disseminate information and evaluate disposal policies.

For devices currently owned by our company and that have low-concentration PCBs, we plan to undertake proper disposal at facilities authorized by the Minister of the Environment to begin disposal from fiscal 2010 under the Waste Disposal and Public Cleansing Law.

Environmental Audits

Multi-faceted Monitoring of Activities with Three Types of Environmental Audits

The Mitsubishi Electric Group works to improve the quality of its environmental management in a diversified manner by utilizing three different types of audits with differing administrators and standards.

The first type is internal environmental audits, conducted by works, R&D centers, and affiliated companies once or twice a year to check on compliance with local and other laws and regulations and conformance with ISO standards at the organization level.

The second type is management system evaluation, conducted by certification bodies under ISO 14001.

The third type is environmental audits conducted by the head office to confirm progress of the Group's Environmental Plan and compliance with related laws. These audits target all branches, works, R&D centers and affiliates in Japan (once every two years for branch offices and works, once a year for affiliated companies). The results of environmental audits are reported to the President by the Executive Officer in Charge of Environment, and are conveyed to the Group's works and affiliated companies via the Environmental Managers' Conference and various reports, to improve the quality of environmental management at each site.

The range of areas covered by environmental audits and inspections within the Group include 1) compliance with environment-related legislation and regulations, 2) measures to prevent environmental accidents such as leakage of hazardous substances, and 3) the status of 6th Environmental Plan implementation.

As properly conducted audits call for a high level of specialized knowledge and communication abilities, we carry out ongoing education for the purpose of training and improving the skills of auditors. We also conduct cross-audits among sites, dispatch instructors to sites from the head office, draw up auditing guidelines, offer training courses over our intranet, and share relevant information across the Group.

Through these three types of audits and the training of auditors who perform them, Mitsubishi Electric will continue to work to qualitatively improve our environmental management.

Three Types of Audits for Environmental Management



Overview of the Three Types of Environmental Audits

	Internal audits conducted by works, factories, R&D centers, and affiliated companies	Environmental audits conducted by the head office	Management system evaluation conducted by ISO certification bodies
Auditing Standards	<ul style="list-style-type: none"> • Laws and regulations • ISO standards • Site-specific regulations • Progress on the Environmental Plan 	<ul style="list-style-type: none"> • Laws and regulations • Company regulations related to the environment • Environmental Plan 	<ul style="list-style-type: none"> • ISO standards
Frequency	Once a year or once every half year	Once a year or every two years	Once a year

Environmental Audits and Inspections by the Head Office

Environmental audits by the head office involve interviewing the management of our branches, works, R&D centers, and affiliated companies. These audits look into the implementation of the Environmental Plan on paper and on-site, covering areas that include the status of legal compliance and environmental risk management (including disaster prevention and safety measures), the use of internal environmental audits, the handling of chemical substances used in products and manufacturing processes, and the status of product assessments and green procurement.

Furthermore, to ensure full compliance with revisions to environmental laws and regulations, we audit the status of compliance at each site in detail and order prompt remedial measures when areas of non-conformance are discovered. Examples of improvement measures for areas of non-conformance are compiled into a booklet and distributed within the Group. We also hold classes to ensure thorough understanding of environmental laws and regulations and raise awareness of compliance-related issues. In fiscal 2010 we held such classes five times, with a total of 467 participants.

Overseas, the head office conducts on-site environmental inspections at production sites, based upon a common global checklist. These diagnoses are aimed at risk management and involve discussions to solve problems at the sites.

In fiscal 2010 we performed environmental audits and inspections at 114 sites (12 at our works, 15 at head office divisions, 5 at branches, 69 at affiliates in Japan, and 13 at overseas affiliates), followed by appropriate remediation and preventative measures to address areas of non-conformance.

In fiscal 2011 we will perform environmental audits and inspections at 114 sites (12 at our works, 15 at head office divisions, 5 at branches, 70 at affiliates in Japan, and 12 at overseas affiliates). We will also conduct follow-up on corrective measures taken in fiscal 2010 and disseminate examples of corrections. In addition to these, we intend to confirm self-declarations of ISO 14001 conformance in overseas affiliates, provide guidance on corrective measures, and check on the status of their environmental management using our check sheet.



On an environmental audit in Japan



On an environmental audit in Asia

Environmental Education

Comprehensive Specialized Programs in Addition to General Education

A feature of Mitsubishi Electric's environmental education is the depth of programs covering specialized fields, complementing general environmental education for all employees.

Examples include the Environmental Management System Professional Course to train internal environmental auditors in the performance of rigorous audits; Key Environmental Personnel Education to train the personnel who shoulder the core tasks of environmental management in factories; and the Waste Course to teach waste handling in accordance with disposal regulations.

In addition, as an example of an educational activity to raise environmental awareness outside the company, we hold the Mitsubishi Electric Outdoor Classroom in regions around the country to foster environmental awareness.

Beginning with "energy conservation leader" education for specialists who will lead production site improvements from an energy conservation perspective, we will continue to expand our environmental education initiatives in the future.

Example of Environmental Education Programs for Employees

Name	Content/features
Key environmental personnel training	<ul style="list-style-type: none"> • Legal requirements vital to factory environmental management, acquisition of knowledge to identify environmental equipment risks and propose improvements • Performance of on-site factory inspections and compliance audits
Environmental management system	<ul style="list-style-type: none"> • Understanding of ISO 14001 standards and their use in management
Design for environment	<ul style="list-style-type: none"> • Acquisition of knowledge and basic concepts surrounding design for environment, the ability to design for separation and disassembly through hands-on experience at appliance recycling plants
Waste management education / regulatory education	<ul style="list-style-type: none"> • Overview of recent legal revisions, courses in waste management • Carry out education on waste management, regulations, etc. at dispatch locations in response to requests by Mitsubishi Electric workplaces and Group companies
Training course for Mitsubishi Electric Outdoor Classroom leaders	<p>Train leaders to firmly establish and expand the Mitsubishi Electric Outdoor Classroom program for fostering environmental awareness</p> <ul style="list-style-type: none"> • Acquisition of knowledge and skills required to operate Classrooms, including points for communication with children and response measures in the event of injury



Key environmental personnel training

Employees with extensive experience in waste management and pollution act as instructors to transfer their skills and experience.



Environmental management system

Remote attendance at courses is possible over the Internet.



Waste course

Nearly 500 persons participate every year.

Training Key Environmental Personnel

Targets of the 6th Environmental Plan (Fiscal 2010–2012)

Expanding Global Environmental Management

Assigning and Training Key Environmental Personnel	
Targets of the 6th Environmental Plan (Fiscal 2010–2012)	Assign and train key environmental personnel at factories in China, Asia, Europe, and America

Amidst ongoing legislation and revision of environment-related regulations each year, responding to changes requires the training of personnel charged with environmental management in the factory.

Every year since fiscal 2005, Mitsubishi Electric and affiliates in Japan have trained over 20 employees as "key environmental personnel", who bring years of experience and expert-level skills in equipment management to the accurate execution of environmental management duties. Under instructors with extensive experience in pollution and waste management, employees selected from around the country undergo group training to learn practical methods including the basics of environmental laws and regulations, analytical technology, risk prediction and management, environmental audits and more.

Under the 6th Environmental Plan, we are assigning key environmental personnel to each factory in Japan while also raising the level of training. We plan to expand education to overseas sites as well from fiscal 2011.

Curriculum of Key Environmental Personnel Training and Abilities Acquired by Trainees

Curriculum	Features	Abilities
Explanation of legal requirements (fundamentals and practical application)	In-house instructors convey required knowledge based on their experience	Ability to understand requirements of environmental laws and regulations, and explain them to others
Identification of risks related to environmental facilities and formulation of improvement measures	Management expertise is conveyed using examples of past accidents and deficiencies	Ability to discover and mitigate latent environmental risks before they materialize
Internal auditing	Onsite inspections and compliance audits are conducted	Ability to perform audits based on experience and knowledge of environmental laws and regulations

Results of fiscal 2010 initiatives

In Japan: Trained 34 key environmental personnel

Overseas: Planned overseas training program

In Japan, we held group training 4 times for environmental managers at Mitsubishi Electric and affiliated companies, training 34 key environmental personnel (cumulative 152 persons since fiscal 2005).

Overseas, we plan to begin the assignment and training of key environmental personnel in fiscal 2011, beginning in China. In fiscal 2010 we started preparations by considering content of the training program.

Planned Initiatives for Fiscal 2011

In Japan: Train 20 or more key environmental personnel

Overseas: Implement key environmental personnel training in China

Domestically, we plan to hold group training four times annually for managers and mid-level employees within Mitsubishi Electric factories and affiliated companies. Moreover, we will work to raise the level of the program through education tailored to the participants.

Overseas, we will launch the program in the key region of China in fiscal 2011 and expand it to other Asian regions in the future.



Key environmental personnel training

Under instructors with extensive experience in pollution and waste management, employees learn practical methods including the basics of environmental laws and regulations, analytical technology, risk prediction and management, environmental audits and more.

Environmental Communication

Disclosing Environmental Information Online and Through Corporate Publications

Since 1998, Mitsubishi Electric has continuously reported on its environmental objectives and achievements through a combination of detailed data and case studies.

Environmental Report Website



Japanese language website 



English language website

Environmental Action Report



Japanese language version



English language version



Chinese language version

In Japan, Mitsubishi Electric launched an independent microsite for its environmental statement "Eco Changes" in June 2009 to disseminate corporate environmental information over the Internet. In December 2009, the Company published a Japanese-language Environmental Statement Booklet and began distributing it to stakeholders.

Eco Changes-related tools



Eco Changes microsite 

Environmental Statement Booklet



Global Environmental Portal Renewed



Global Environmental Portal 



Promoting 3R Activities at Mitsubishi Electric Automotive America 



Our Commitment 

A Word from the Developer

Until recently, Mitsubishi Electric had disseminated environmental information from its overseas offices through websites managed and operated by specific business units or individual overseas offices. Although there was a great deal of information, the issue of how to access that information remained. As a result, the Company launched a project to develop a portal website where all of its environmental information could be accessed from a single easy-to-navigate location, and which could also assist business.

However, launching the portal is one thing, but there is also the need to use the site to continually provide timely and meaningful news and updates from the Company. Accordingly, the developer visited our network of overseas offices with a draft version of the portal and used various meetings and other opportunities to introduce the purpose and operational procedures for the site. There was some anxiety about the project's achievability until the test version was completed, but now information for uploading to the site is provided on a regular basis from our international offices.

Currently, Mitsubishi Electric is moving toward its goal of expanding global environmental management. As such, we would like to make this portal one means to support the realization of our environmental objectives and targets by sharing the progress of our environmental management expansion initiatives around the world.

Corporate Advertising Division
Corporate Communications Group

Environmental Exhibitions

6th Eco-Products International Fair

The 6th Eco-Products International Fair (EPIF) was held from March 4th to 7th 2010 in Jakarta, Indonesia. Sponsored by the Asian Productivity Organization (APO), the EPIF is held in turn in different locations in Asia. Mitsubishi Electric has participated each time since the 2nd EPIF in Thailand. At the 6th EPIF, Mitsubishi Electric introduced its Environmental Vision 2021 and the key technologies, activities and environmentally effective product lineup, such as photovoltaic systems and air conditioning products, being used to achieve it. The company is also making efforts to spread the use of its environmentally effective products in Indonesia.



Eco-Products 2009

Eco-Products 2009, held at Tokyo Big Sight from December 10th to 12th 2009, attracted a record crowd totaling 182,510 people. Under the theme "Eco Changes — Eco Changes from in the Home to Outer Space," the Mitsubishi Electric Group, introduced its Eco Changes initiatives and innovative technologies in the four areas of homes, offices, factories and outer space.



CEATEC JAPAN 2009

CEATEC JAPAN 2009, one of Asia's largest comprehensive advanced IT and electronics exhibitions, was held from October 6-10 at Makuhari Messe in Chiba, Japan. For the first time, Mitsubishi Electric's exhibit featured a zone dedicated to the environment, at which we presented Eco Changes, and introduced energy usage visualization in the home, energy conservation solutions for entire buildings, our home appliance recycling business and observation satellites that monitor the environment from space.



Environmental Advertising

Mitsubishi Electric advertises its broad range of environmental technologies and products through a variety of media around the world.



Example of Environmental Advertisement



Key Technologies website

The Key Technologies website highlights Mitsubishi Electric's environmental technologies using easy-to-understand animations and images.

Dialogue with Stakeholders



Idea exchange meeting on biodiversity

Mitsubishi Electric actively communicates with stakeholders through factory tours and company-organized environmental classes for educational institutions and local communities.

In fiscal 2010, the Company also invited stakeholders to participate in company-sponsored overseas forums and idea exchange meetings on biodiversity initiatives.

Environment & Energy Conservation Private Forum in Shanghai

Mitsubishi Electric co-sponsored the Environment & Energy Conservation Forum¹ held in Shanghai on August 26th 2009. The theme of the forum was "experts in energy conservation, devoted to environmental protection," which expresses our commitment to contribute to environmental conservation through our environmental and energy-saving technologies.

The forum featured keynote speeches and a panel discussion by speakers including Chinese government officials and the Head of Mitsubishi Electric's Corporate Environmental Sustainability Group. Mitsubishi Electric's seven operating companies in China² also held five workshops on the topics of energy-saving air conditioning, energy-

saving semiconductors, energy-efficient elevators, eco-F@ctory and water treatment technology, with the purpose of sharing information on key technologies.

In the keynote addresses, Chinese government officials discussed the challenges and importance of lowering carbon emissions as a nation that is a major consumer of energy, while the Mitsubishi Electric speaker talked about the need to spread the seeds of technology in order to cultivate the buds of energy conservation and environmental protection in aiming to create a low-carbon and recycling-based society, and highlighted the innovative energy conservation activities underway at Mitsubishi Electric's Dalian production site. In the workshops, university professors and Mitsubishi Electric engineers and technicians participated as lecturers and panelists, leading active discussions on how to promote energy conservation. After the forum, which attracted over 500 participants, many shared their views on their experience, stating, "the specialist technical forums and lectures made it very practical," and "I was able to understand the potential for growth and contribution to the environment and society."



The forum was widely covered by domestic media in China, including newspapers, television news and the Internet.

Moving forward, along with lobbying related government offices responsible for environmental policy decisions, Mitsubishi Electric will continue to convey to its customers its broad range of technologies that contribute to environmental conservation.

- 1 Forum Sponsors: China Business News and Tongji University; Co-sponsors: Mitsubishi Electric Corporation and Mitsubishi Electric (China) Co., Ltd. (MEC) (also responsible for planning and event management)
- 2 Mitsubishi Electric & Electronics (Shanghai) Co., Ltd.; Mitsubishi Electric Shanghai Electric Elevator Co, Ltd.; Guangdong Ryoden Lift & Escalator Co., Ltd.; Shanghai Mitsubishi Elevator Co., Ltd.; Shanghai Mitsubishi Electric & Shangling Air-Conditioner and Electric Appliance Co., Ltd.; Mitsubishi Electric Air-Conditioning & Visual Information Systems (Shanghai) Ltd.; Mitsubishi Electric Automation (Shanghai) Ltd.

A Word from the Forum's Sponsor

The Environment & Energy Conservation Private Forum in Shanghai ended up being a project that spanned one year from the planning to execution stages. During this time, I had the opportunity to witness firsthand the commitment that Mitsubishi Electric Group employees place on environmental conservation through their resolving of related challenges and becoming leaders in environmental conservation activities. This served to reaffirm my view of Mitsubishi Electric as a company that focuses on CSR.



Ms. Sammi Chen
China Business News

Today, environmental issues, including climate change and natural resource depletion, are becoming more and more apparent. A two degree Celsius change in temperature may represent a minute and hard-to-detect difference, but this is enough to affect the entire world. Facing a worsening global environment, humankind must work together to resolve the challenges of climate change. I feel that, as a Japanese company, the Mitsubishi Electric Group is leveraging its superior technical competencies to contribute greatly to the environment and energy conservation. During the project, I also became aware of Mitsubishi Electric's corporate statement, "Changes for the Better." Knowing this helps me firmly believe the future will be an even better place.

Environmental Report

Product-Related Initiatives



▶ Design for Environment

Basic Stance
Applying Factor X

▶ Reducing CO₂ from Product Usage

Introducing objectives and results of Fiscal 2010 initiatives to promote energy-saving products that are helping to create a low-carbon society.

▶ Reducing Resource Inputs

Progress in Fiscal 2010
Closed-Loop Recycling of Plastics

▶ Complying with Chemical Substance Regulations

Green Accreditation System
Status of RoHS Compliance
Status of REACH Compliance

▶ Recycling End-of-Life Products

Objectives and progress of our initiatives to collect and recycle home appliances and on our trial development of advanced recycling technologies.

Design for Environment

▶ Basic Stance

Promoting Design for Environment activities based on product assessments that take into consideration three perspectives—effective use of resources, efficient use of energy and avoiding emissions of substances with potential environmental risk.

▶ Applying Factor X

Mitsubishi Electric strives to create products with minimal environmental impact by using Factor X, an index based on the product value and its environmental effects.

Design for Environment

Basic Stance

Aiming for More Advanced Design for Environment

Reducing CO₂ Emissions and Resource Inputs in line with Environmental Vision 2021

Since fiscal 2004, the Mitsubishi Electric Group has promoted design for environment based on product assessments made from a MET¹ perspective, and has conducted evaluations using LCA². In pursuing design for the environment, we have determined targets for individual products by utilizing the Factor X environmental efficiency improvement index. Products whose factor had improved over the previous fiscal year were designated as Eco-Products, while products whose factor had improved by more than two were designated as Hyper Eco-Products.

From fiscal 2004 to fiscal 2009, we aimed to improve our Eco-Products ratio, which measures the ratio of Eco-Products to total production output. Since targets had been almost achieved³ as of fiscal 2009, however, we determined that design for environment had been sufficiently incorporated into our activities. As a result, we no longer use Eco-Products ratio to measure related progress and targets.

Given this positive result, moving forward Mitsubishi Electric plans to strengthen initiatives in the two categories of reducing CO₂ from product usage and reducing resource inputs as stipulated in the 6th Environmental Plan (fiscal 2010 to fiscal 2012), while continuing to manage targets using Factor X.

- 1 "MET" stands for Material (the effective use of material resources), Energy (the efficient use of energy), and Toxicity (avoiding emissions of toxic substances with potential environmental risk).
- 2 LCA stands for Life Cycle Assessment. This product assessment approach seeks to quantitatively and comprehensively evaluate the environmental impacts of products beginning with the collection of resources and continuing through design, manufacturing, transportation, usage, and end-of-life processes.
- 3 A 100% target was set for mass-produced products, including home electronics and mass-produced industrial mechatronics, while an 80% target was set for other products, which includes individual production and built-to-order production. At the end of the term, mass produced products had achieved 99%, while other products had achieved 81%, both in line with original targets.

The Concept of Design for the Environment

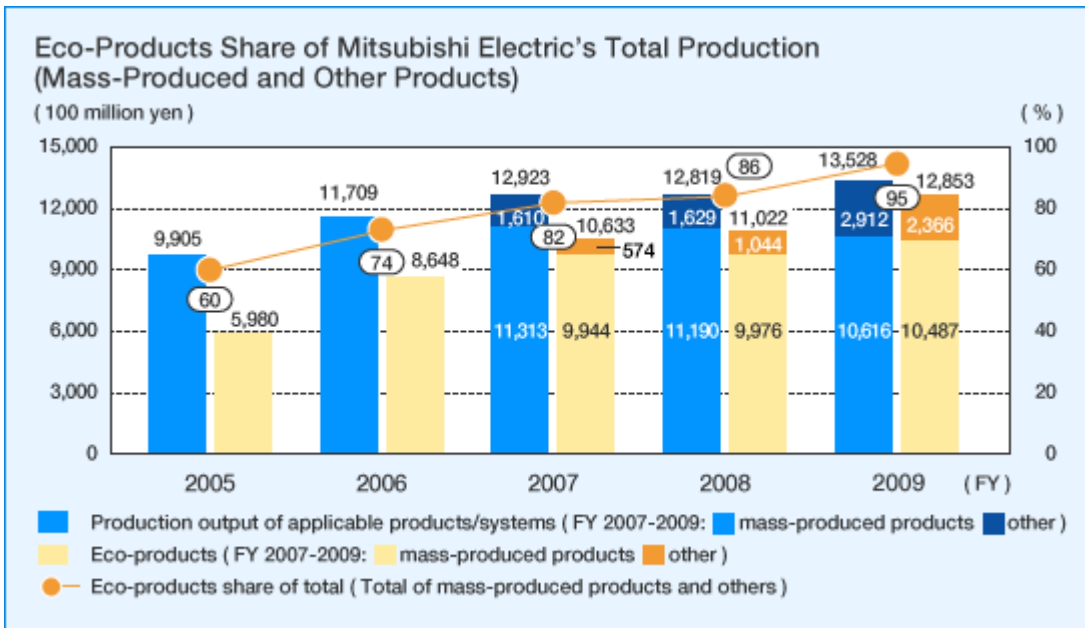
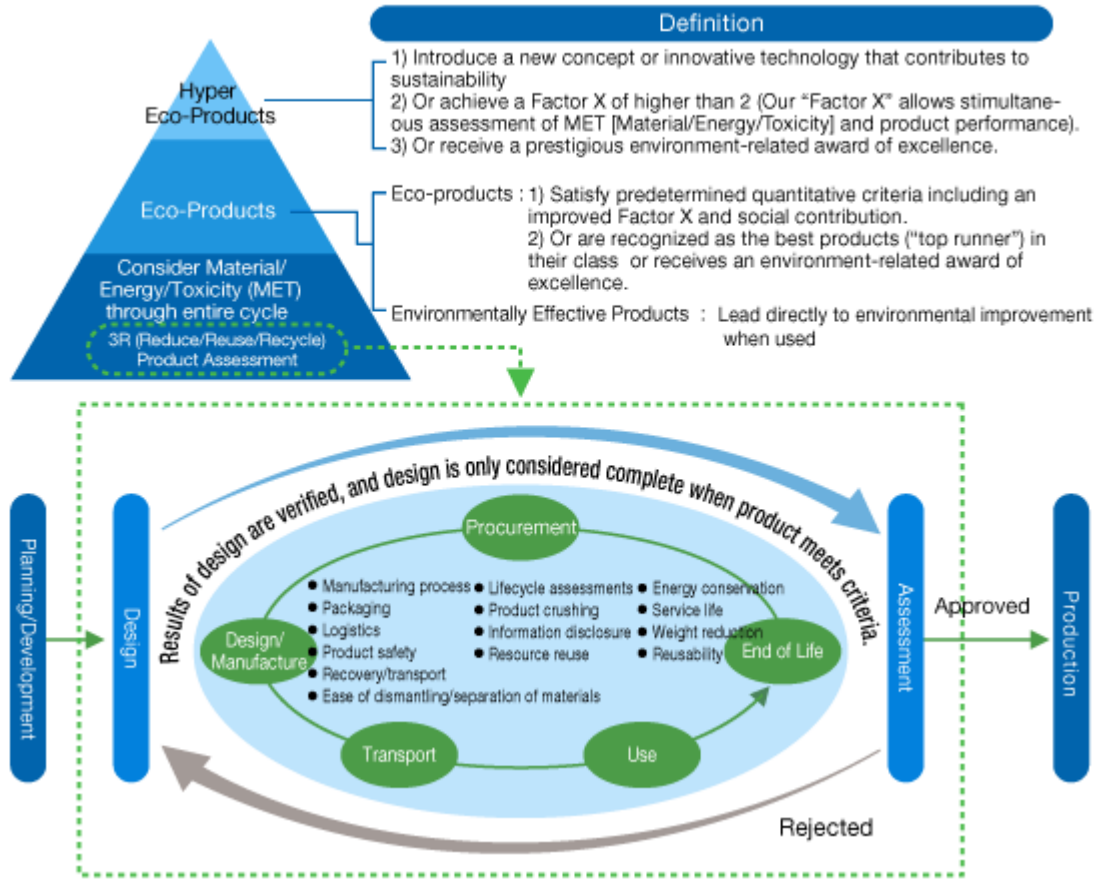

Design for Environment

Applying Factor X

Factor X: Measuring Improvements in the Environmental Efficiency of Products

Index Based on the Product Value and Environmental Impact

Factor X is an index that quantifies the idea of maximizing product value while minimizing impact on the environment. "X" is a value that compares a new product to a baseline product. The larger the X value, the greater the improvement in product performance and the lower the environmental impact. For example, a factor of 4 indicates a fourfold improvement in environmental consideration. Our calculation of Factor X is based upon 3 elements: reduction of resource inputs, reduction of the amount of energy used in production, and avoidance of emissions of substances with potential environmental risk. To these three we also add level of product performance improvement.

While we continue to use Factor X, Mitsubishi Electric is also investigating better ways of assessing product value, so that we may produce superior products with a lower environmental impact, and help achieve Environmental Vision 2021.

Basic Concepts to Calculate Factor X

- Comparison between a new product and a baseline product (in principle, we use Mitsubishi Electric products and a base year of 1990).
- Evaluations of the performance factor (improvement in product performance) and the environmental impact factor (degree of environmental impact reduction) are multiplied together to produce the rating.
- The performance index is evaluated by basic functions (product functions, performance, quality, etc.) multiplied by product life¹. The environmental impact of a product is evaluated using a sub-index for 1) non-recycled materials², 2) energy consumption, 3) toxicity ("MET," where M is the consumption of non-recycled resources, E is the amount of energy or power consumption, and T is the presence of substances with potential environmental risk), from which the environmental impact is calculated for the new product (using a value of 1 for the baseline product), and the final environmental impact index is represented by the length of the vector that combines the three sub-indexes.

1 The performance index is defined separately for each product.

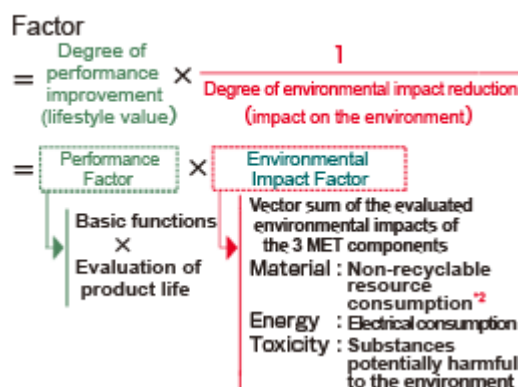

2 Sub-index for the consumption of non-recycled resources=virgin resource consumption + non-recyclable volume (i.e. the volume disposed of without being recycled) = [weight of product - volume of recycled materials and parts] + [weight of product - recyclable volume]

● Factor Calculation



Reducing CO2 from Product Usage

6th Environmental Plan (FY2010-FY2012)
Targets and Progress as of FY2010

Reducing CO2 from Product Usage				
6th Environmental Plan (FY2010-FY2012) (FY2012 Targets)		FY2010		FY2011
		Achievements	Self-Assessment of Progress	Target
Average Reduction Rate for Target Products	25% (Base year: FY2001)	23%		24%
Expansion of Target Products	43 Products → 80 Products	70 Products		75 Products

CO2 emissions resulting from product usage can total between 40 to 50 times more than the amount emitted during the production process (Mitsubishi Electric calculation). That means we can greatly contribute to the creation of a low-carbon society by striving to make our products more energy efficient. In aiming to achieve our target of reducing CO2 emissions from product usage by 30% as outlined in our Environmental Vision 2021, Mitsubishi Electric is systematically selecting key target products and finding ways to reduce their CO2 emissions, with the ultimate goal of improving the average CO2 reduction rate in fiscal 2012 by 25% compared to fiscal 2001 levels.

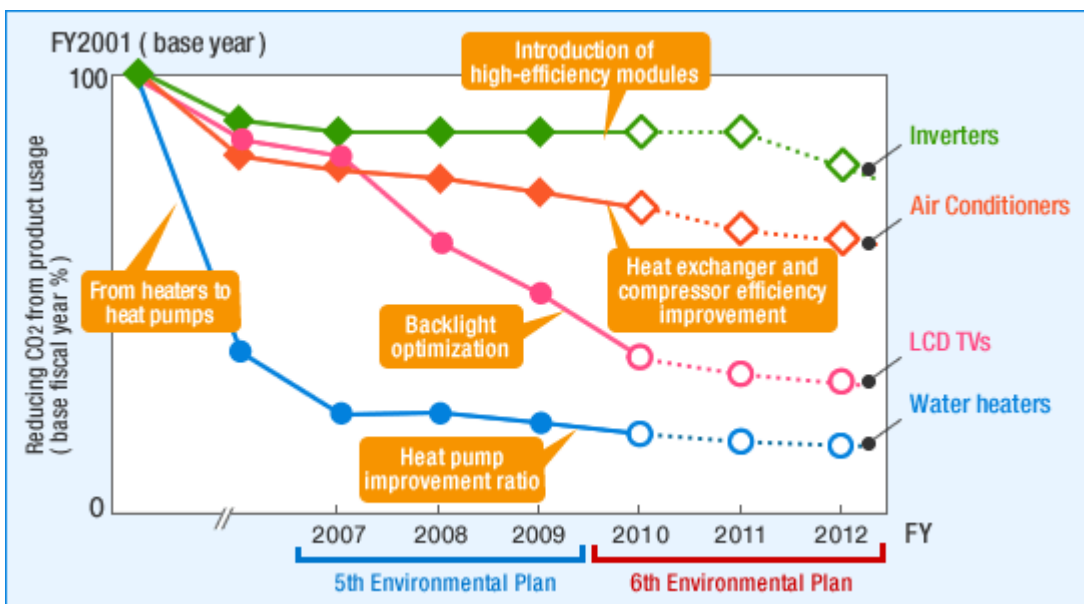
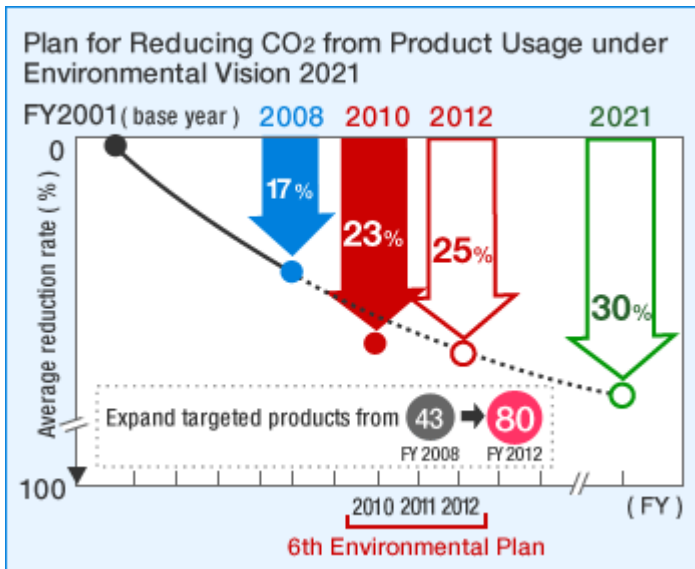

Target Products Expanded to 70 in Fiscal 2010, and 23% CO2 reduction achieved

In fiscal 2010, Mitsubishi Electric expanded the number of products targeted by our CO2 reduction initiatives to 70. Products are selected after a careful review of product families from all of our business groups,* based on the product's potential for lowering CO2 emissions caused by its use. As a result of each business group's active efforts, we've greatly expanded the number of target products. In addition, our average CO2 reduction rate in fiscal 2010 reached 23%.

To make these target products more energy-efficient, the development plans compiled annually by each business group include products to be focused on in that year, and indicates clear numerical targets for reducing energy consumption.

Aiming for average 30% reduction in CO2 emissions from use of targeted products

One effective way to reduce CO2 emissions from product usage is to make power source components more efficient to reduce energy loss. As a majority of the energy consumed by electrical products is used to drive motors, Mitsubishi Electric is well positioned to support energy savings through its fundamental technologies, such as the inverters used to control motors and the power semiconductors used in inverters. We've leveraged our expertise in these technologies and advanced further innovations to produce more energy-efficient products, with the goal of reducing CO2 emissions from the use of target products by an average of 30% in 2021.

[Click here to learn more about our technical innovations](#)

* All business groups: Energy & Electric Systems, Industrial Automation Systems, Information & Communication Systems, Electronic Devices, Home Electronics and Other (the six business groups appearing in our annual financial report)

Product-Related Initiatives

Reducing Resource Inputs

Progress in Fiscal 2010

We expanded the number products intended to help reduce resource inputs by 30% as per the objectives of Environmental Vision 2021. We progressed steadily in making products smaller and more lightweight.

Closed-Loop Recycling of Plastics

We succeeded in creating a recycling technology that can automatically separate the three main plastics at a purity of more than 99%.

Reducing Resource Inputs

Progress in Fiscal 2010

6th Environmental Plan (FY2010-FY2012) Targets and Progress in FY2010

Reducing Resource Inputs		FY2010		FY2011
6th Environmental Plan (FY2010-FY2012) (FY2012 Targets)		Results	Self Assessment of Progress	Target
Average Reduction Rate for Target Products	18%	34%	😊	30%
Expansion of Target Products	32 Products → 60 Products	51 Products	😊	60 Products

Mitsubishi Electric is committed to reducing the amount of resources used in its products through the promotion of plastics recycling and designing its products to be more compact and lightweight. We plan to increase the number of target products under this initiative to exceed 60 by fiscal 2012 (the number realized for fiscal 2009 was 32) and aim to reduce resource inputs by 30% of fiscal 2001 levels.

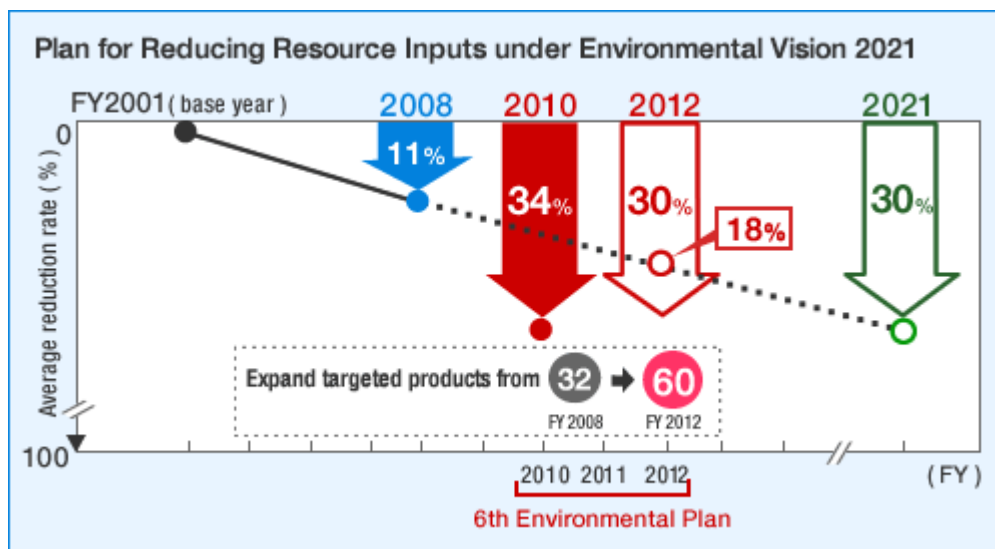

Target Products Expanded to 51 in FY2010! Further Expansion to 60 Planned for FY2011!

Mitsubishi Electric increased the number of target products under this initiative to 51 in fiscal 2010, which is within close range of the target set for fiscal 2011. In addition, after a careful review of product families from all business groups* in fiscal 2010, we have determined target products to be included in this initiative for the period until fiscal 2021. In fiscal 2011 we will expand the number of target products to 60. The annual development plan compiled by each business group also includes products set to be included in this initiative and indicates clear numerical targets for reducing resource inputs.

The average reduction for target products was 34% in fiscal 2010, which far outpaces our 18% reduction target established for fiscal 2012. Moving forward, Mitsubishi Electric will aim to maintain at least a 30% reduction rate for all target products as outlined in its Environmental Vision 2021.

*All business groups: Energy & Electric Systems, Industrial Automation Systems, Information & Communication Systems, Electronic Devices, Home Electronics and Other (the six business groups appearing in our annual financial report)

Reducing Resource Inputs

Closed-Loop Recycling of Plastics

Established a Technology to Automatically Separate the Three Major Plastics at Over 99% Purity

Aiming to Increase Closed-loop Recycling of Plastic to 10 Times Current Levels

Mitsubishi Electric has developed a system for the closed-loop recycling of plastics from end-of-life products—said to be difficult to recycle compared to metals—into reusable plastic raw materials.

Mitsubishi Electric established this system in fiscal 2009. The system automatically separates the three main plastics—polypropylene (PP), polystyrene (PS) and acrylonitrile butadiene styrene (ABS)—at over 99% purity from shredded mixed plastics. First, water is used to separate out the comparatively light PP using its specific gravity. Next, ABS and PS, which are heavier than water and cannot be separated based on difference in specific gravity, are sorted using electrostatic technology that separates the two plastics by electrical charge. Once the separation process is complete, X-rays are used to promptly identify and eliminate substances subject to RoHS compliance*, which has allowed us to expand the use of such recycled plastics in home appliances.

Starting in 2010, Mitsubishi Electric launched Green Cycle Systems Corporation, a new plant that applies this technology to make possible the closed-loop recycling of approximately 7,000 tons of plastics annually. It was the first large-scale high-purity plastic recycling program in Japan.

Until now, Mitsubishi Electric relied on the home appliance recycling plant Hyper Cycle Systems Corporation to retrieve 6%, or approximately 600 tons of its annual 10,000 tons of total plastic waste generated from the dismantling of home electronics, which was in turn reused in new products. With the start of operations at its new plant, Mitsubishi Electric can now separate and collect an additional 6,400 tons (total of 7,000 tons) of recycled plastic for use in home electronics. This amount corresponds to approximately 18% of all plastics used in our home electronics products. The use of recycled plastics from this new system will reduce our CO₂ emissions by an annual 7,300 tons in comparison to producing new plastics from petroleum (Mitsubishi Electric calculation).

* Restriction of Hazardous Substances (RoHS): Directive enacted by the European Union in July 2006 that aims to restrict six specific dangerous substances used in home electronics and electronic equipment. The six restricted substances are lead, mercury, cadmium, hexavalent chromium, PBB (polybrominated biphenyls), and PBDE (polybrominated diphenyl ether). There are instances where miniscule amounts of fire retardant plastic containing high concentrations of bromine may get mixed in when separating shredded mixed plastics.

Large-Scale High-Purity Recycling at Materials Recycling Plant

More than tenfold increase
in plastic recycling over current levels

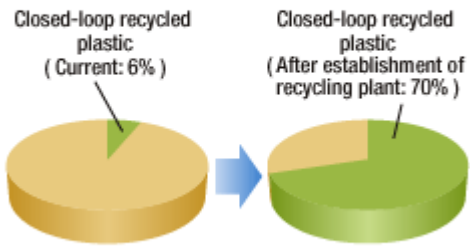

* Ratio of plastic recycled in a closed loop to the total amount of plastic generated at Hyper Cycle Systems Co., Ltd (10,000 tons)

Complying with Chemical Substance Regulations

Green Accreditation System

To minimize environmental risks, we implemented the Green Accreditation system based on the Green Procurement Standards Guide.

Status of RoHS Compliance

We continue our non-usage and traceability control for the specified substances from a compliance standpoint.

Status of REACH Compliance

We are operating a Chemical Substance Information Management System to obtain and furnish the information required by laws and regulations.

Complying with Chemical Substance Regulations

Green Accreditation System

Introducing a Green Accreditation System to Reduce Environmental Risk

Green Accreditation Rate for Business Partners is 100% for the Second Consecutive Year.

In April of 2006 the Mitsubishi Electric Group introduced a Green Accreditation System based on the Green Procurement Standards Guide established in September of 2000. The purpose of this system is to assess the environmental initiatives and status of chemical substance management for each supplier that provides components/materials used in our company's products, or secondary materials used in product manufacturing. By certifying business partners that comply with our company standards, we ultimately minimize environmental risks.

To date, Mitsubishi Electric has held conferences for our business partners about green procurement, and proposed improvements to enhance their environmental initiatives. At the end of fiscal 2009, we achieved a 100% accreditation rate for suppliers, and also maintained this rate in fiscal 2010. Aiming to maintain this 100% accreditation rate, we are currently carrying out a variety of activities including certification renewals.

Towards the goal of respecting biodiversity, in September 2009 Mitsubishi Electric added Appendix I to the Green Procurement Standards Guide, explaining the connection between green procurement and the preservation of biodiversity. Going forward, based on the Mitsubishi Electric Group Biodiversity Action Guidelines established in April 2010, we will continue to think of ways to respect biodiversity in materials procurement, and reflect these in our Green Accreditation System.

Mitsubishi Electric Group Biodiversity Action Guidelines
Green Procurement

Green Procurement Standards Guide, Appendix I,

English Edition (PDF: 766 KB) 

Chinese Edition (PDF: 5.0 MB) 

Complying with Chemical Substance Regulations

Status of RoHS Compliance

Complying with the EU's RoHS Directive and China's Administrative Measure on the Control of Pollution Caused by Electronic Information Products

Continuing Non-Usage and Traceability Control for the Six Specified Substances

The Mitsubishi Electric Group is constantly revising its chemical control systems to conform to current regulations. When new developments arise we respond promptly.

As of December 2005, we have stopped using the six specific substances¹ restricted by the EU's RoHS Directive, which went into effect on July 2006. China's Administrative Measure on the Control of Pollution Caused by Electronic Information Products² went into effect in March 2007. The first stage makes it mandatory for labeling to include information on the six specified substances. Product labels must include the environmental period of validity (the period during which the product can be used without causing serious environmental pollution) and the manufacturing date. In fiscal 2007, we achieved compliance with these requirements.

In fiscal 2010, we continued our non-usage and traceability controls for specified substances from a compliance perspective, acquiring information from suppliers on the inclusion of chemical substances in parts and materials, as well as non-usage certificates to ensure reliability. In cases when a possible contamination risk is suspected, we carry out an analysis ourselves to confirm the presence or absence of the substances.

Deliberations over the revision of the EU's RoHS Directive are done during 2010. China is also scheduled to announce the major management items for its Administrative Measure on the Control of Pollution Caused by Electronic Information Products. We are now gathering the relevant information and making ongoing preparations for compliance.

- 1 The six substances are lead, mercury, cadmium, hexavalent chromium, polybrominated biphenyl (PBB) and polybrominated diphenyl ether (PBDE).
- 2 Administrative Measure on the Control of Pollution Caused by Electronic Information Products is the so-called Chinese version of the RoHS Directive. These regulations were developed jointly by Chinese Industry and the Ministry of Industry and Information Technology, together with central government agencies, including China's National Development and Reform Commission and the Ministry of Commerce. The regulations make it mandatory to provide information and labeling for the six substances specified by the EU's RoHS Directive.

Complying with Chemical Substance Regulations

Status of REACH Compliance

Definite Steps toward REACH Compliance

The REACH Regulation¹ established by an agreement at the World Summit on Sustainable Development, held in September 2002, states as its objectives, "that chemicals are used and produced in ways that lead to the minimization of significant adverse effects on human health and the environment by 2020." The EU enacted this regulation in June 2007. This regulation requires that data be gathered on the types and amounts of chemical substances used in not only chemical products such as paints and adhesives but also electronic and electric products.

In Japan, both the upstream chemical manufacturing industries and downstream product manufacturing industries cooperated to launch JAMP² in September 2006. JAMP created a common labeling system to disseminate information about the chemical substances present in raw materials, parts, and consumer products. At the end of June 2009, the Joint Article Management Promotion consortium's Global Portal (JAMP-GP) began operations, in order to facilitate access to this information.

In fiscal 2010, Mitsubishi Electric, as a member of JAMP, held a conference to demonstrate the JAMP labeling system to our business partners and affiliated companies, domestic and overseas, (Asia, China, and Europe) that are required to control chemical substances contained in the products.

In December we began operating the Chemical Substance Information Management System, which allows us to provide and receive information from our business partners regarding the substances contained in product materials. This system stores information on substances contained in procured items and our products; the data is stored on the company's application server (MelcoAS), allowing us to exchange information with our business partners through JAMP-GP. We are going to utilize this system to comply with REACH and other regulations.

- 1 REACH Policy: EU regulations requiring the Registration, Evaluation, Authorisation and Restriction of Chemicals. Under REACH, companies must register and evaluate the safety of the approximately 30,000 types of chemical substances sold in the EU. Information on regulated chemical substances³ contained in electronic, electrical, and all other products (articles) covered by requirements must be provided to customers and reported to the European Chemicals Agency.
- 2 JAMP: The Joint Article Management Promotion consortium. JAMP is a volunteer organization with 351 member companies (as of April 12, 2010) from the chemical, electronic and electrical equipment, automobile, and other industries. JAMP's activities are overseen by the Japan Environmental Management Association for Industry.
- 3 Regulated chemical substances include carcinogens, chemicals that persist in the environment, and bio-accumulative substances.
At the first announcement in October 2008, 15 substances were presented, at the second notification in January of 2010, 14 types were added and at the third announcement in March 2010 there was one more addition, for a total of 30 items as of April 2010. Going forward, this list will be updated with additional substances up to twice a year, and could ultimately exceed 1,000 items.

Recycling End-of-Life Products

Recycling Four Kinds of Home Appliances

Japan's Home Appliances Recycling Law* makes the collection and recycling of four classes of items compulsory: air conditioners, televisions, (CTR, LCD, and plasma models), refrigerators/freezers, and washing machines/clothes dryers. The results of Mitsubishi Electric's collection and recycling efforts in fiscal 2010 are shown in the chart.

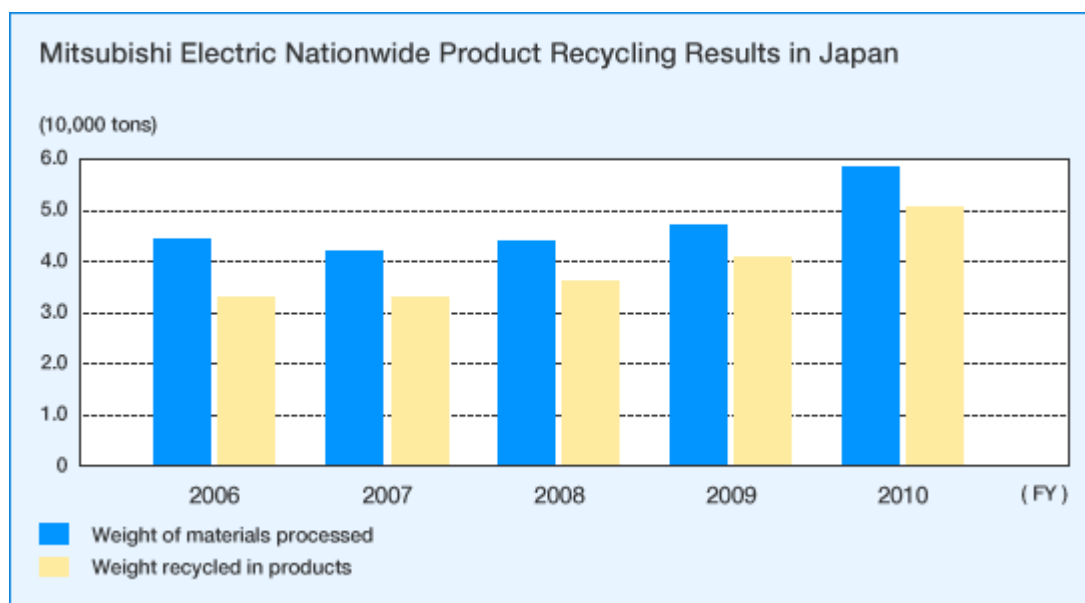

In 1999 Mitsubishi Electric commenced operations at our recycling plant (Hyper Cycle Systems Co., Ltd.), the first of its kind in the industry. Here, we carry out highly efficient recycling and work to develop more advanced recycling technologies. By the end of fiscal 2010, Hyper Cycle Systems Co., Ltd. had recycled 430,000 tons of material.

Also, we are using the information we gain through operations at Hyper Cycle Systems Co., Ltd. to guide our efforts to design highly recyclable products. For example, the MSZ-ZW719S-T series air conditioners released (in Japan) in 2009 were designed to facilitate dismantling by assuring that insulating material was not attached to the recyclable plastic parts. The REAL series LCD televisions released (in Japan) in 2008 have a label affixed to the back side of the set indicating the number of screws necessary to dismantle the set, and the length and type of screw is also shown near the anchoring section. Since waste plastic is more difficult than metal to recycle effectively we are working to recycle it internally.

* Home Appliance Recycling Law: this law makes it compulsory for parties involved to collect and dispose of home appliances like televisions, refrigerators, washing machines, air conditioners, etc. (April 2001). Manufacturers and importers must recycle steel, copper, aluminum, and glass and are also responsible for setting up a system to recycle the products that they handle. The law was amended in December 2008 to also include LCD and plasma televisions and clothes dryers.



Home Appliance Collection and Recycling (Fiscal 2010)

	Unit	Air Conditioners	Televisions		Refrigerators/ Freezers	Washing Machines/ Clothes Dryers	Total
			CRT	LCD / Plasma			
Units received at designated collection points	1,000 units	296	814	3	335	197	1,645
Units processed	1,000 units	291	714	2	332	194	1,533
Weight processed	Tons	12,038	20,358	40	19,921	6,558	58,915
Weight recycled in products	Tons	10,909	18,498	32	15,388	5,837	50,664
Ratio recycled in products	%	90	90	80	77	89	-

Technology for the High-Purity Recycling of Waste Plastic

Waste plastic is more difficult to recycle than metal. Mitsubishi Electric is working to develop new recycling technologies and to multiply our efforts toward closed-loop recycling. In fiscal 2009, the company established technology for recovering the three primary types of plastic — PP (polypropylene), PS (polystyrene), and ABS (Acrylonitrile Butadiene Styrene) — at purity levels exceeding 99%. We began utilizing this technology at our materials recycling plant, Green Cycle Systems Corporation, which began operation in 2010, establishing Japan's first large-scale, high-purity plastic recycling system, capable of recovering approximately 6,400 tons of high-purity plastic per year.

To date we have recovered about 6% of the 10,000 tons of dismantled plastic collected at Hyper Cycle Systems and reused it in our home appliances. But with the start of operations of our materials plant, Mitsubishi Electric will be able to achieve the closed-loop recycling of some 7,000 tons of plastic.

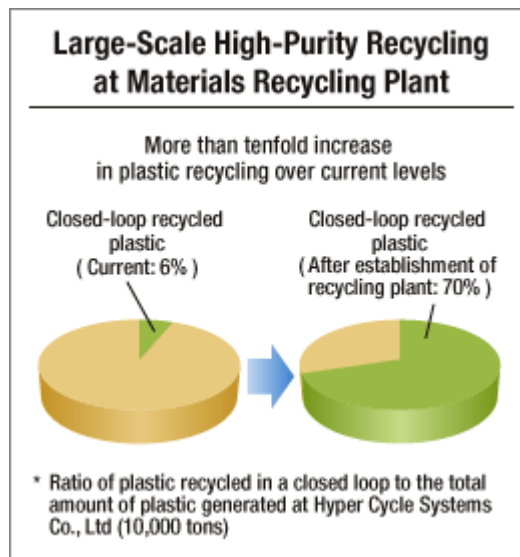

Environmental Topics — Recycling Waste Plastics

Recycling Personal Computers

Mitsubishi Electric is promoting the recycling of used computers and monitors. In fiscal 2010, we collected a total of 3,871 computers (home and office), which represented a recycling rate of 76.9%.

For end-of-life home computer equipment we have implemented a plan of marking used computers with a PC Recycle Mark¹ tag to waive the disposal fee. For some products, customers are required to register the machine after purchase in order to get the tag themselves, but the procedure is very straightforward. Mitsubishi Electric has made it possible for customers to obtain recycling tags by sending in a postcard or requesting one via the Internet². When we receive a disposal request for a product sold in October 2003 or later, we determine whether the product is eligible for a recycling tag to ensure the customer does not pay the recycling fee twice.

There is a risk of data leakage from the hard disk drives of disposed computers. Although computer users have the basic responsibility for preventing data leaks, the companies we have contracted to recycle computers punch holes in the hard disk drives or use a strong magnet to destroy any data physically and magnetically, in order to prevent any confidential data from being leaked. Interested computer owners can also pay for a program to delete all data completely before their used computers are taken away.

- 1 PC Recycle Mark: the recycle mark stipulated by industry group PC3R Promotion Association was established to promote the 3R's (reduce, reuse, recycle) among manufacturers, merchants, and importers of computers and monitors. From October 2003 onward they began targeting home personal computer and monitor users. The tag may be displayed on merchandise at the time of purchase or available afterward through registration.
- 2 Because Mitsubishi Electric stopped selling home-use PCs in fiscal 1999, the Recycle Mark is available only for PC displays.

Material Recycling from Used Computers (Home and Office) (Fiscal 2010)

	Unit	Desktop		Notebooks		CRT Displays		LCD		Total	
		Office	Home	Office	Home	Office	Home	Office	Home	Office	Home
Collected	Tons	20.0		2.2		20.8		4.0		47.0	
		16.9	3.1	2.0	0.2	17.7	3.1	3.8	0.2	40.4	6.6
		1,495		709		1,011		656		3,871	
Number of units collected	Units	1,263	232	640	69	841	170	630	26	3,374.0	497.0
		20.0		2.2		20.8		4.0		47.0	
		17.0		1.4		14.3		3.3		36.1	
Weight recycled	Tons	20.0		2.2		20.8		4.0		47.0	
Weight reused	Tons	17.0		1.4		14.3		3.3		36.1	
Recycling ratio	%	85.0		65.0		69.0		83.4		76.9	

Compliance with the WEEE Directive

According to the WEEE Directive enacted by the European Union in February 2003, manufacturers with products on the market in Europe are required to affix a seal to their products indicating that the product is designed to facilitate the sorting and recycling of its component materials.

Moreover merchants are required to bear the cost of the collection and recycling fees. In order for the Mitsubishi Electric Group to comply completely with the WEEE Directive, we must understand the laws regarding its enforcement in each individual country. We are compiling the necessary information and making it available. Furthermore, so that no manufacturer fails to register and that no party fails to participate in the collection effort, we are confirming our WEEE compliant products, retailer's registration, participation in collection, payment of fees, etc.

In addition, we are independently collecting some commercial equipment. We are also actively preparing for possible revisions to the WEEE Directive by the EU, and for revisions by individual countries to their own domestic policies.

Mitsubishi Electric is observing legal trends in the European Commission and EU member countries, and improving the proper structure to comply with the WEEE Directive. At the same time, we are continuing in our planning efforts toward improved recycling.

*The WEEE Directive

To prevent the generation of waste electrical and electronic equipment and reduce the processing volume of such equipment, WEEE aims to reuse and recycle waste. EU member countries, distributors and manufacturers must fulfill their responsibility at each stage of design, sorting, collection and recycling.

Environmental Report

Product Environmental Data

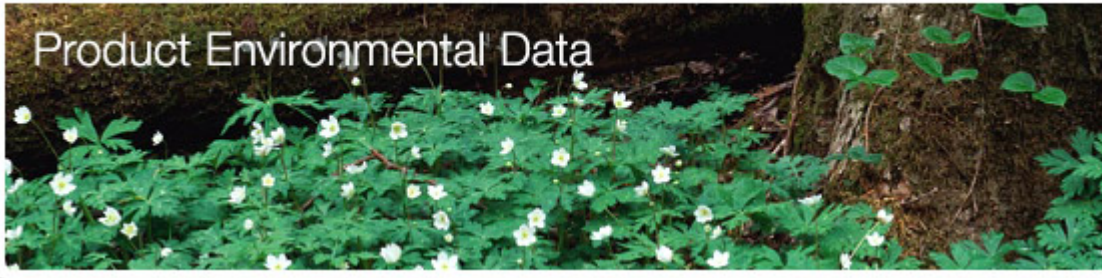

▶ Energy & Electric Systems

Ozone Generator
Super Energy Efficient Transformers
Elevator Systems
Escalator **NEW**

▶ Industrial Automation Systems

Electronic Hybrid Functional Control Panel
Computerized Numerical Controller
Wire Electric Discharge Machine
Automatic Power Factor Controller
Electronic Measuring Instrument
Electronic Multi-Measuring Instrument
Energy Measuring Unit
Laser Processing Machine
EPS Motor
Spindle Motor **NEW**

▶ Information & Communication Systems

Optical Network Unit
Mitsubishi Logistics Information System:
Dr. Logis
Integrated Environmental Information
System
Environmentally Resistant Wide-Area
Optical Ethernet Switch **NEW**
UHF-Band RFID Reader-Writer **NEW**
WDM Optical Transmission
Equipment **NEW**
Information Equipment Recycling
Service **NEW**

▶ Electronic Devices

DIP-IPM Module
Laminated Bus Bar **NEW**

▶ Home Appliances

Jet Towel Hand Dryer **NEW**
Hot Water Floor Heating System
Compact Cube for Commercial Use
Room Air Conditioner
Refrigerator
Photovoltaic Module **NEW**
Photovoltaic Inverter
Eco Cute for Household Use **NEW**
Eco Cute for Commercial
Applications **NEW**
Ventilator
Energy Recovery Ventilator for Commercial
Use **NEW**
Lossnay Central Ventilator System **NEW**

Energy & Electric Systems

In the area of heavy electric machinery systems, Mitsubishi Electric is contributing broadly to society by lowering the environmental burden of energy systems and infrastructure systems, which are used in many places throughout society.



■ Ozone Generator



■ Super Energy Efficient Transformers



■ Elevator Systems



■ Escalator

Energy & Electric Systems

Ozone Generator

Super Energy Efficient Transformers

Elevator Systems

Escalator

Ozone Generator OS

Produces high-concentration ozone efficiently for lower life-cycle costs

The Ozone Generator is a device that produces ozone gas using electrical discharge. A high voltage with high frequency is applied between two electrodes to produce a discharge space. Oxygen gas or air is then passed through the space and some of the oxygen is converted to ozone. Ozone is a gas consisting of three bonded oxygen atoms. It has sterilization and oxidation properties that are more powerful than chlorine. It also has exceptional deodorization and de-pigmentation abilities. Water treatment systems that use the power of ozone have been recognized for their purification capabilities and environmental compatibility. They continue to be installed at sites involved in potable water treatment, sewage treatment and industrial wastewater treatment. The Ozone Generator OS produces high-concentration ozone efficiently. It generates concentrations as high as 240 g/m³ (N), an improvement upon Mitsubishi Electric's previous model, which could produce an ozone concentration as high as 150 g/m³ (N).



M Materials: Effective use of resources

- Approximately 40% lower weight compared to previous Mitsubishi Electric model.

E Energy: Efficient use of energy

- Approximately 10% lower power consumption compared to previous Mitsubishi Electric model.

T Toxicity: Avoidance of substances that are potentially harmful to the environment

- Unlike sterilization and oxidation using chemicals such as chlorine, ozone breaks down after treatment and reverts to oxygen, which prevents environmental pollution.

Note

Shortening the length of the discharge gap has allowed Mitsubishi Electric's Ozone Generator to produce high-concentration ozone efficiently. The discovery and application of this technology has been duly recognized, leading to it being honored with the following awards.

1. 21st Century Invention Prize at the 2006 National Invention Awards
"Technology for producing high-concentration ozone efficiently"
2. Japan Machinery Federation Chairman's Prize at the 2006 Outstanding Energy Efficient Device Awards
"Tubular type ozone generator with small discharge gap"
3. Prime Minister's Award at the 2007 Japan Industrial Technology Awards
"High-concentration generator with very small discharge gap"

Energy & Electric Systems

Ozone Generator
Escalator

Super Energy Efficient Transformers

Elevator Systems

Transformers: Super Energy Efficient Transformers (EX Series)

Hyper Eco-Product

Factor 1.183: Performance Factor 1.00:
Environmental Load Factor 1.183

Transformers use electromagnetic induction to step-down the high-voltage electricity (e.g. 6600v) supplied by electric utilities to voltage levels used in buildings and factories. Super Energy Efficient Transformers contribute to energy efficiency by lowering operating losses, and reduce CO₂ emissions. These transformers also employ a design that reduces operating noise.



Reasons for Hyper Eco-Product Certification

- Products certified to carry Mitsubishi Electric's environmental mark

Detailed equipment data

- ▶ RA-TS

M Materials: Effective use of resources

- To create no-burden and lower-burden products, we increased our resources by around 40%.

E Energy: Efficient use of energy

- By creating no-burden and lower-burden products, we lowered our electric power consumption by approximately 57%.

T Toxicity: Avoidance of substances that are potentially harmful to the environment

- Eliminate the use of hexavalent chrome.

Note

Super Energy Efficient Transformers are larger and more massive than current top-performing transformers (energy-efficient models), but offer greater energy efficiency.

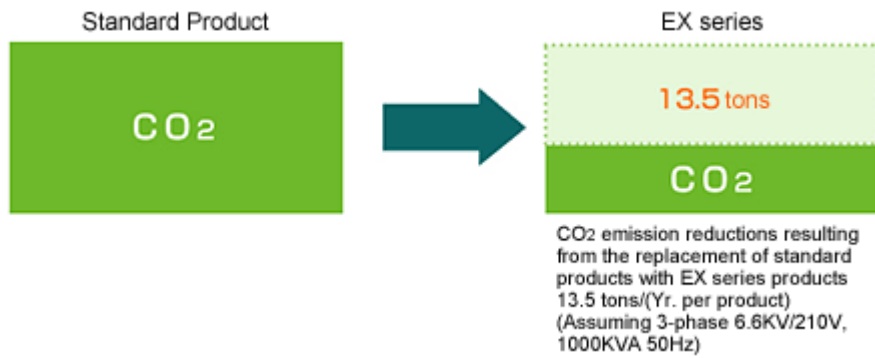

To illustrate, if all of the transformer shipments for a year were replaced with Super Energy Efficient Transformers, CO₂ emissions would be reduced by 90,000 tons. Super Energy Efficient Transformers, therefore, not only reduce energy consumption; they also help to lower environmental burden.

Energy & Electric Systems

Ozone Generator
Escalator

Super Energy Efficient Transformers

Elevator Systems

Elevator Systems: Number of persons: 9, Speed: 60m/min., 6 stops

Factor 1.09: Performance Factor 1.00:
Environmental Load Factor 1.094
(applies only to lift equipment)
* Factors for standard products are fiscal 1996 products.

Responding to diversifying needs, we enhanced the performance and functionality of existing elevator equipment. In addition, to provide greater construction and design freedom, we reduced the amount of space necessary for elevator shafts.

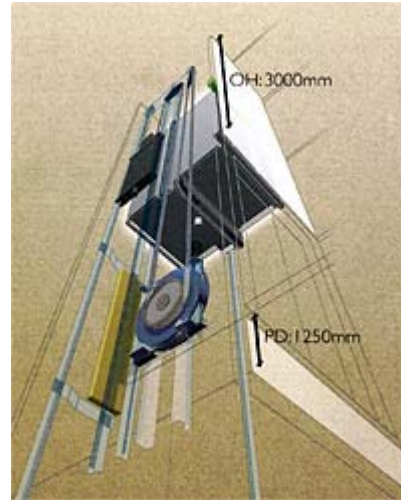

Detailed equipment data

- ▶ P9-CO-60, 6stop

M Materials: Effective use of resources

- Reduced the weight of car equipment. (Car floor: Approx. 20kg; Car balustrade: Approx. 5kg; Counterweight: Approx. 25kg)
- Employed corn-based plastic for part of the car control panel.

E Energy: Efficient use of energy

- Switched to inverter technology for lighting, and reduced electricity consumption by up to 35%.
- Use regenerative electric power to reduce electricity consumption by about 20%. (When equipped with the optional "Ele-save" package)

T Toxicity: Avoidance of substances that are potentially harmful to the environment

- RoHS-compliant parts and materials are used. (Switched to lead-free options for six types of boards, and plating free of hexavalent chrome.)
- Reduced usage of toluene, xylene, and other atmospheric and the soil contaminants.
- In compliance with sick-house laws and regulations, reduced emissions of controlled substances to levels at or below standards for entire elevator systems. Reduced formaldehyde concentrations to levels below the standard of 100µg/m³.

Energy & Electric Systems

Ozone Generator

Super Energy Efficient Transformers

Elevator Systems

Escalator

Escalator ZJ-S

Factor: 1.280

Performance Factor: 1.000*

Environmental Impact Factor: 1.280

*No performance factor evaluation for this product.

ZJ-S constitutes a new escalator design providing high quality and reliability. Particular attention was paid to safety and convenience in creating this design.



Detailed equipment data

► ZJ-S

M Materials: Effective use of resources

- The ZJ-S design is characterized by its relatively small number of parts and light weight. Installing ZJ escalators for floor heights of 6.5–7.0 m results in the use of less material than required by other escalator models.
- To minimize the amount of material used in truss members, the size of the truss chords and other parts was scaled down, resulting in lighter parts and overall weight reduction.
- Recyclable thermoplastic polyurethane handrails and rollers were installed.

E Energy: Efficient use of energy

- An optional automatic operation function helps make the escalator more energy efficient. A line of VVVF inverter-based post and postless products that stop/slow down when not in use has been prepared; combining these features with variable speed functionality results in expanded application for automatic operation functions.

T Toxicity: Avoidance of substances that are potentially harmful to the environment

- Active employment of RoHS-compliant parts and materials (Switched to lead-free boards, and plating free of hexavalent chromium.)
- Reduced usage of toluene, xylene, and other atmospheric and soil contaminants.

Industrial Automation Systems

In industrial Mechatronics, we help customers reduce their environmental burden by increasing the energy- and resource-efficiency of various devices that are indispensable for industry.



▶ **Electronic Hybrid Functional Control Panel**



▶ **Computerized Numerical Controller**



▶ **Wire Electric Discharge Machine**



▶ **Automatic Power Factor Controller**



▶ **Electronic Measuring Instrument**



▶ **Electronic Multi-Measuring Instrument**



▶ **Energy Measuring Unit**



▶ **Laser Processing Machine**



▶ **EPS Motor**



▶ **Spindle Motor**

Industrial Automation Systems

Electronic Hybrid Functional Control Panel | Computerized Numerical Controller
Wire Electric Discharge Machine | Automatic Power Factor Controller
Electronic Measuring Instrument | Electronic Multi-Measuring Instrument
Energy Measuring Unit | Laser Processing Machine | EPS Motor | Spindle Motor

Electronic Hybrid Functional Control Panel MACTUS 30LCB

Integration simplifies and enhances the performance of water treatment plants

With conventional systems for power instrumentation and control at drinking water treatment facilities, sewage treatment facilities and other water treatment plants, it was necessary to produce, install, wire and coordinate (on-site) separate control panels for power, control and instrumentation circuits. The Electronic Hybrid Functional Control Panel consolidates these previously separate circuits and reduces the number of control panels to save space, reduce wiring, lower power consumption and provide high-performance electrical facilities. It is the first Mitsubishi Electric product that has been certified with the Eco-Leaf environmental label (conforms to the ISO Type III framework).



M Materials: Effective use of resources

- Fewer control panels and less wiring due to integration of previously separate functions.
- Systems previously requiring three control panels can be configured with two panels (scope of consolidation differs depending on the size of the plant).

E Energy: Efficient use of energy

- Energy is saved through consolidating previously separate functions and by integrating and changing controls from H/W circuits to S/W circuits. Power consumption is reduced by up to 40% compared to Mitsubishi Electric's previous system (energy savings differ depending on the size of the plant).

Industrial Automation Systems

Electronic Hybrid Functional Control Panel | **Computerized Numerical Controller**
Wire Electric Discharge Machine | Automatic Power Factor Controller
Electronic Measuring Instrument | Electronic Multi-Measuring Instrument
Energy Measuring Unit | Laser Processing Machine | EPS Motor | Spindle Motor

Computerized Numerical Controller M700VS Series



Factor 2.72: Performance Factor 1.12:
Environmental Load Factor 2.429

Best controller for top level manufacturing

The Computerized Numerical Controller is a computer that accurately controls the amount of movement and speed of machine tool implements.

With fewer long-life parts, such as HDDs and the cooling fans, part replacement maintenance and machine tool waste is also reduced.



Reasons for Hyper Eco-Product Certification

- Factor X is more than or equal to 2

Detailed equipment data

- ▶ M700VS Series

M Materials: Effective use of resources

- Compact and lightweight resource-saving design (volume: 13% reduction mass; 29% reduction).

E Energy: Efficient use of energy

- We have developed the high-efficiency and electric power saving graphic circuit, which reduces power consumption by approximately 66% compared to the previous model.

T Toxicity: Avoidance of substances that are potentially harmful to the environment

- Conforms to the EU RoHS Directive; the occurrence of six regulated substances (lead, mercury, cadmium, hexavalent chromium, PBB, and PBDE) is controlled.

Industrial Automation Systems

Electronic Hybrid Functional Control Panel | Computerized Numerical Controller
Wire Electric Discharge Machine | Automatic Power Factor Controller
Electronic Measuring Instrument | Electronic Multi-Measuring Instrument
Energy Measuring Unit | Laser Processing Machine | EPS Motor | Spindle Motor

Wire Electric Discharge Machine NA series



Factor NA1200:4.60 NA2400:3.91
Performance Factor NA1200:3.086 NA2400:3.086
Environmental Load Factor NA1200:1.492 NA2400:1.267

Next-generation WEDM provides high-precision machining and lower running costs

A wire electric discharge machine is a type of machine tool classified by JIS regulations as a special processing machine. It provides precision machining by utilizing electrical discharge between the workpiece and wire electrodes to melt and remove the workpiece. It uses significantly less power and wire than Mitsubishi Electric's previous model, helping to reduce running costs.



NA1200

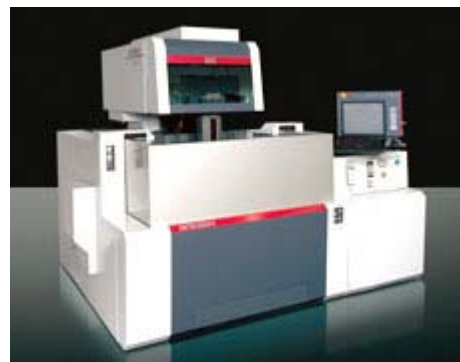

NA2400

Reasons for Hyper Eco-Product Certification

- Factor rating of 3 or more

Detailed equipment data

- ▶ NA1200
- ▶ NA2400

M Materials: Effective use of resources

- Optical product design delivers increased processing size (due to a larger machine) without increasing the amount of cast metal used.
- Unit design reduces total number of parts.
- Resources saved by digitizing the user's manual.

E Energy: Efficient use of energy

- A new power supply reduces processing time by as much as 30% compared to the previous Mitsubishi Electric model.
- Brand new control system called Intelligent Master reduces wire consumption by up to 44% compared to the previous Mitsubishi Electric model.
- New "wake-up mode" function reduces standby power consumption.
- Total power consumption is cut by up to 69% compared to the previous Mitsubishi Electric model.

T Toxicity: Avoidance of substances that are potentially harmful to the environment

- New components were selected for the circuit board. Circuit boards with lead-free solder substantially reduce the amount of lead used.

Note

The NA Series was designed to provide delicate, high-precision machining and lower running costs while also being operator friendly and easy to use. The NA 2400 Series features 37% more machine strokes, an especially large table and an automatic elevation tank. The work position can be checked from three directions, which makes large work set-up easy. The product is also readily compatible with automation via robots or other automation equipment.

Additionally, a survey of worker movement resulted in improvement to the positioning of the control unit, which helps the product achieve Universal Design ideals.

The product's user-friendly design was recognized, and it was awarded a Good Design Award for fiscal 2008.

Industrial Automation Systems

- Electronic Hybrid Functional Control Panel
- Computerized Numerical Controller
- Wire Electric Discharge Machine
- Automatic Power Factor Controller**
- Electronic Measuring Instrument
- Electronic Multi-Measuring Instrument
- Energy Measuring Unit
- Laser Processing Machine
- EPS Motor
- Spindle Motor

Automatic Power Factor Controller VAR-6A / VAR-12A VAR-12A / JT-SB216GSN

Factor 1.73: Performance Factor1.20:
Environmental Load Factor1.43

Features automatic condenser capacity recognition and a large LCD display

Automatic power factor controllers are installed on power distribution and receiving facilities at buildings and factories to enable effective use of electrical facilities. They detect reactive power and control the connection and disconnection of power condensers to achieve the ideal power factor. Setup of the controller has been simplified with a function for automatically recognizing condenser capacity, while adoption of a large LCD display improves visibility. Also, the number of parts has been reduced, which simplifies disassembly.



VAR-6A



VAR-12A

Reasons for Eco-Product Certification

- Factor rating of 1.2 or more

Detailed equipment data

- ▶ VAR-6A / VAR-12A

M Materials: Effective use of resources

- Parts reduced by 11% compared to the previous model (VAR-6)

T Toxicity: Avoidance of substances that are potentially harmful to the environment

- Eliminated the use of the six substances specified by the EU's RoHS directive.

Industrial Automation Systems

Electronic Hybrid Functional Control Panel	Computerized Numerical Controller
Wire Electric Discharge Machine	Automatic Power Factor Controller
Electronic Measuring Instrument	Electronic Multi-Measuring Instrument
Energy Measuring Unit	Laser Processing Machine
	EPS Motor
	Spindle Motor

Electronic Measuring Instrument ME96NSR-MB / ME96NSR

Factor 1.67: Performance Factor 1.2:
Environmental Load Factor 1.39

Small and flexible instrument compatible with DIN 96 × 96 size

Electronic multi-measuring instruments are installed on power receiving and distribution facilities at buildings and factories. The instruments measure electricity, including voltage, current, power and electrical energy, in order to provide information on how electricity is being received and used. Measurements can be displayed directly on the meter or relayed remotely via a communication function. Parts and connection types have been reduced, which simplifies disassembly.

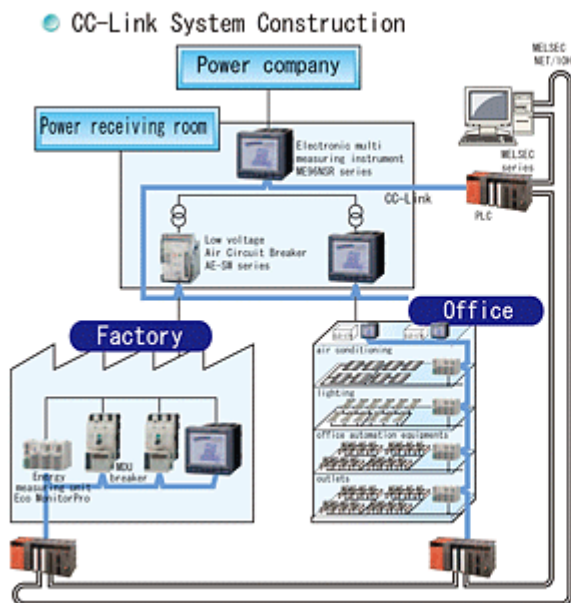

Reasons for Eco-Product Certification

- Factor rating of 1.2 or more

Detailed equipment data

- ▶ ME96NSR-MB / ME96NSR

M Materials: Effective use of resources

- Compact and lightweight.
- Instrument design makes it easy to add and remove communication modules, I/O modules and other add-ons.

E Energy: Efficient use of energy

- Electricity consumption reduced by 25% compared to Electronic Multi-Measuring Instrument.

T Toxicity: Avoidance of substances that are potentially harmful to the environment

- Eliminated the use of the six substances specified by the EU's RoHS directive.

Industrial Automation Systems

Electronic Hybrid Functional Control Panel | Computerized Numerical Controller
Wire Electric Discharge Machine | Automatic Power Factor Controller
Electronic Measuring Instrument | **Electronic Multi-Measuring Instrument**
Energy Measuring Unit | Laser Processing Machine | EPS Motor | Spindle Motor

Electronic Multi-Measuring Instrument

**ME110NSR / ME110NSR-4A2P / ME110NSR-4APH / ME110NSR-C
ME110NSR-MB**

Factor 1.70: Performance Factor 1.20:
Environmental Load Factor 1.41

High functionality and ease of use

Electronic multi-measuring instruments are installed on power receiving and distribution facilities at buildings and factories. The instruments measure electricity, including voltage, current, power and electrical energy, in order to provide information on how electricity is being received and used. Measurements can be displayed directly on the meter or relayed remotely via a communication function. Parts and connection types have been reduced, which simplifies disassembly.



ME110NSR

Reasons for Eco-Product Certification

- Factor rating of 1.2 or more

Detailed equipment data

- ▶ ME110NSR

M Materials: Effective use of resources

- Parts reduced by 15% compared to previous model.
- Connection types reduced by 40% compared to previous model.

E Energy: Efficient use of energy

- Electricity consumption reduced by 30% compared to previous model.

T Toxicity: Avoidance of substances that are potentially harmful to the environment

- Eliminated the use of the six substances specified by the EU's RoHS directive.

Industrial Automation Systems

Electronic Hybrid Functional Control Panel | Computerized Numerical Controller
Wire Electric Discharge Machine | Automatic Power Factor Controller
Electronic Measuring Instrument | Electronic Multi-Measuring Instrument
Energy Measuring Unit | Laser Processing Machine | EPS Motor | Spindle Motor

Energy Measuring Unit (EcoMonitorPro)



Factor 3.96: Performance Factor 2.50:
Environmental Load Factor 1.582

These gauges make it possible to measure electricity usage for electric power systems covering multiple factories and buildings at the level of individual facilities or lines, and at 1-second or 1-minute intervals.



Reasons for Hyper Eco-Product Certification

- Factor rating of 2 or more

Detailed equipment data

- ▶ EMU2-HM1-B

M Materials: Effective use of resources

- Reduced virgin resource usage in products by 45%.
- Reduced the volume of unrecyclable materials by 45%.

E Energy: Efficient use of energy

- Reduced electricity consumption by 51% during usage and 82% during standby.

T Toxicity: Avoidance of substances that are potentially harmful to the environment

- Reduced the amount of lead used in solder by 12.5%.

Industrial Automation Systems

Electronic Hybrid Functional Control Panel | Computerized Numerical Controller
Wire Electric Discharge Machine | Automatic Power Factor Controller
Electronic Measuring Instrument | Electronic Multi-Measuring Instrument
Energy Measuring Unit | **Laser Processing Machine** | EPS Motor | Spindle Motor

Laser Processing Machine LVP-40CF



Factor 3.108: Performance Factor 3.50:
Environmental Load Factor 0.888



Laser processing machines fall into the "Special Processing Machinery" JIS classification. Laser processing machines heat, weld, and ablate by using the characteristics and high energy of a laser beam. The LVP-40CF creates a $\phi 10$ hole in the SPCcT1.0 sample part 3.5 times faster than existing machines.

Reasons for Hyper Eco-Product Certification

- An environmental load factor of 2 or higher

Detailed equipment data

- ▶ LVP-40CF

M Materials: Effective use of resources

- Increase in resource usage through higher rigidity achieved with greater processing speed and precision.

E Energy: Efficient use of energy

- Increase in drive energy usage through high-speed, high-precision processing.

T Toxicity: Avoidance of substances that are potentially harmful to the environment

- Lead-usage reduction through the use of fewer parts attached with solder.

Note

Our laser oscillation and processing technology has been recognized for its excellence and has received the following awards.

- 2001 Nikkan Kogyo Shimbun's 43rd Great New Product Award
- 2002 Japan Machinery Foundation's Chairman's Prized at the Outstanding Energy Efficient Device Awards

Industrial Automation Systems

Electronic Hybrid Functional Control Panel | Computerized Numerical Controller
Wire Electric Discharge Machine | Automatic Power Factor Controller
Electronic Measuring Instrument | Electronic Multi-Measuring Instrument
Energy Measuring Unit | Laser Processing Machine | **EPS Motor** | Spindle Motor

EPS Motor (30A Class)

Factor 1.451: Performance Factor 1.085:
Environmental Load Factor 1.337

The EPS Motor is used in power steering systems, which provide assistance in turning automobile steering wheels. Because the electric power steering system (EPS) engages the motor only when the steering wheel is being turned, it consumes less energy than the traditional hydraulic power steering system (HPS), which is driven by a hydraulic pump that is constantly in operation when an engine is on. This can result in a fuel efficiency improvement of about 3%-5%. Replacing HPSs with EPSs, therefore, would increase fuel economy and significantly reduce CO₂ emissions.

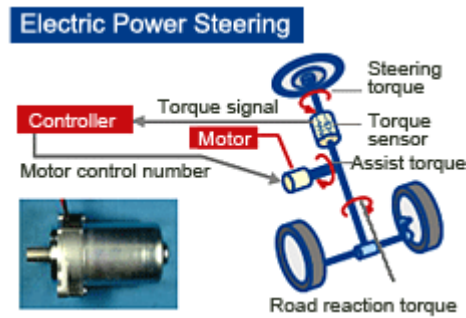

M Materials: Effective use of resources

- Use of closed-loop recycled plastic consisting of waste recovered from the formation process to make a holder for protecting and securing a magnet on the stator.
- Reduction of copper coil edge line parts volume through innovations in edge line processing for windings.
- Weight reduction through simplification of the structure of the connection parts for attachment of the mechanism side to the motor.

E Energy: Efficient use of energy

- Increased energy efficiency through optimal electromagnetic design of the rotor winding coil.

T Toxicity: Avoidance of substances that are potentially harmful to the environment

- Eliminated environmental burden substances covered by the EU-ELV Directive's phased usage restrictions, and reduced usage of other heavy metals.

Note

Received the fiscal year 2007 Commendation for Science and Technology by the Minister of Education Culture, Sports, Science and Technology.

Received the fiscal year 2007 Commendation for Science and Technology by the Minister of Education Culture, Sports, Science and Technology for our EPS (motor and controller). Mitsubishi Electric was praised for benefiting the global environment by making it possible to switch from HPSs to EPSs, and increase fuel economy by 3%-5%.

Industrial Automation Systems

Electronic Hybrid Functional Control Panel | Computerized Numerical Controller
Wire Electric Discharge Machine | Automatic Power Factor Controller
Electronic Measuring Instrument | Electronic Multi-Measuring Instrument
Energy Measuring Unit | Laser Processing Machine | EPS Motor | **Spindle Motor**

Spindle Motor SJ-D Series

Factor: 1.470
Performance Factor: 1.000*
Environmental Impact Factor: 1.470
*No performance factor evaluation for this product.



The SJ-D Series Spindle Motors Fusing Next-Generation Functionality and Design

Spindle motors are used to rotate the cutting edges and processing tools of machining centers, lathes and other machine tools. Mitsubishi Electric continues to strive for energy savings and resource conservation in its products as part of its environmental countermeasures. In addition to such environmental considerations, the SJ-D Series of spindle motors also offers enhanced safety and reliability, and delivers maximum motor performance.

In a field where industrial equipment products have a lifespan in excess of 10 years, this series fuses functionality and design to become a product unaffected by prevalent trends. The SJ-D Series of spindle motor received a Good Design Award (Best 15) in 2009.

Detailed equipment data

▶ SJ-D

M Materials: Effective use of resources

- The SJ-D Series' revised electrical design cuts the use of copper wiring by 43%, while its optimized structure lowers the parts count.

E Energy: Efficient use of energy

- The optimal electrical design facilitates a 25% reduction in motor power loss compared with conventional models, lowering power consumption.

T Toxicity: Avoidance of substances that are potentially harmful to the environment

- Compliant with European RoHS Directive.

Information & Communication Systems

In information and communication systems, Mitsubishi Electric provides solutions based on advanced IT technology, and supports customers' environmental activities by helping them to gather, analyze, and apply environmental burden information.



■ Optical Network Unit



■ Mitsubishi Logistics Information System: Dr. Logis



■ Integrated Environmental Information System



■ Environmentally Resistant Wide-Area Optical Ethernet Switch



■ UHF-Band RFID Reader-Writer



■ WDM Optical Transmission Equipment



■ Information Equipment Recycling Service

Information & Communication Systems

Optical Network Unit | Mitsubishi Logistics Information System: Dr. Logis
Integrated Environmental Information System
Environmentally Resistant Wide-Area Optical Ethernet Switch
UHF-Band RFID Reader-Writer | WDM Optical Transmission Equipment
Information Equipment Recycling Service

Optical Network Unit GE-PON ONU

Hyper Eco-Product

Factor 24.11: Performance Factor 6.67:
Environmental Load Factor 3.62

Provides high-speed broadband over optical fiber

The GE-PON system makes high-speed broadband over optical fiber to the home possible by connecting and terminating optical fiber installed in the home. Using passive optical network, or PON, technology, one strand of optical fiber can be shared by up to 64 users, which reduces device size and cuts power consumption. The system provides a pleasant Internet experience with speeds as high as 1 Gbps.

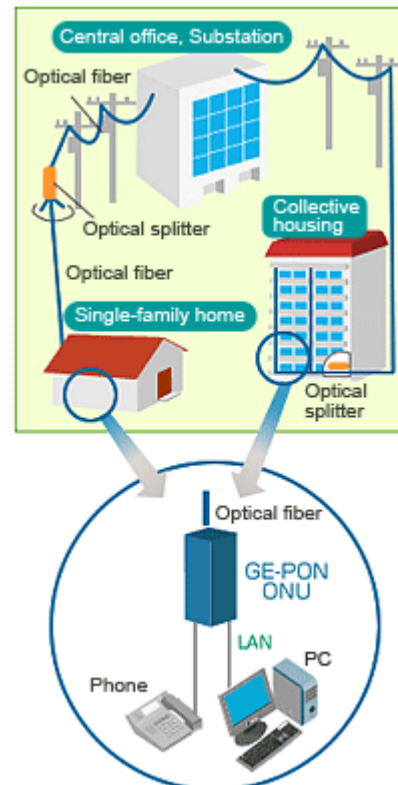

Reasons for Hyper Eco-Product Certification

- Significant electricity consumption reduction achieved by reducing the number of parts compared to previous equipment
- Factor rating of 2 or more
- Lead-free

Detailed equipment data

- ▶ GE-PON ONU

M Materials: Effective use of resources

- Virgin resource consumption reduced substantially by making the product smaller and eliminating metal materials.
Iron: 0.046kg→0kg
Aluminum: 0.306kg→0kg
Plastic: 0.5kg→0.133kg

E Energy: Efficient use of energy

- Eliminating parts with high power consumption (FPGA) reduced power consumption by 65% compared to the previous Mitsubishi Electric product.

T Toxicity: Avoidance of substances that are potentially harmful to the environment

- Complies with Europe's RoHS Directive
- Uses lead-free solder

Information & Communication Systems

- Optical Network Unit | Mitsubishi Logistics Information System: Dr. Logis
- Integrated Environmental Information System
- Environmentally Resistant Wide-Area Optical Ethernet Switch
- UHF-Band RFID Reader-Writer | WDM Optical Transmission Equipment
- Information Equipment Recycling Service

Information & Communication: Mitsubishi Logistics Information System: Dr. Logis

Dr. Logis is a system that supports optimal, realistic vehicle dispatch planning for distribution. It reduces the number of vehicles, distance traveled, and time required when delivering the same quantities under the same conditions.

Trucks burning diesel, gasoline, or other fossil fuels are used in delivery work. Reducing distance and time traveled by minimizing the number of vehicles used and optimizing distribution routes for cases in which the same quantities are being delivered reduces fuel usage and, ultimately, NOx and CO2 emissions.

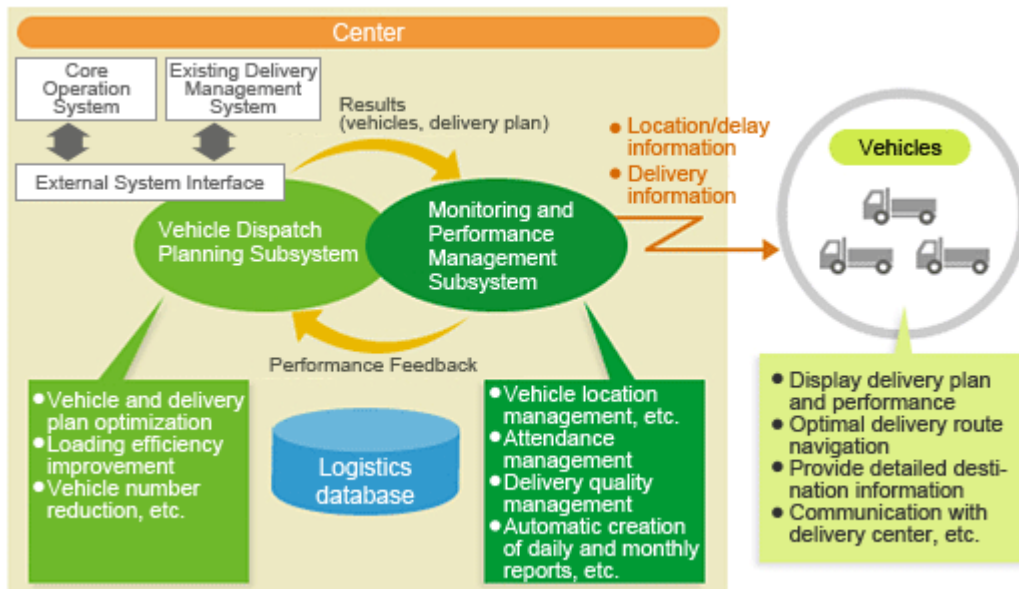

Information & Communication Systems

Optical Network Unit | Mitsubishi Logistics Information System: Dr. Logis

Integrated Environmental Information System

Environmentally Resistant Wide-Area Optical Ethernet Switch

UHF-Band RFID Reader-Writer | WDM Optical Transmission Equipment

Information Equipment Recycling Service

Information & Communication: Integrated Environmental Information System (EORates)

EORates is an information system that, when applied in information sharing and communication, promotes legal compliance, risk avoidance, and environmentally conscious management through the introduction of IT to environmental management. EORates is comprised of three subsystems: the Waste Management System, Environmental Information Sharing System and Chemical Substances Information System.

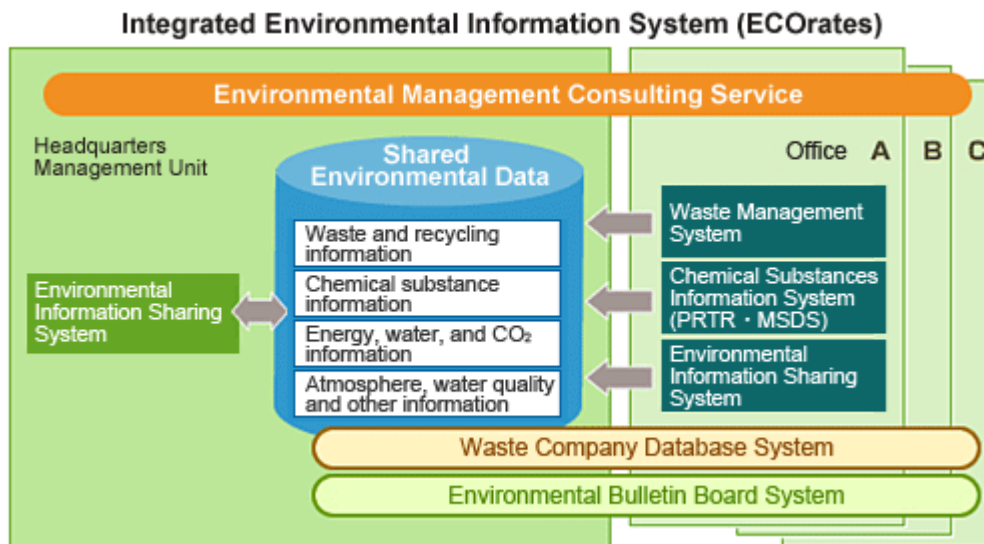

M Materials: Effective use of resources

- Adding to our use of industrial waste management systems, we have taken steps that make it possible to manage all wastes generated, including general waste and materials with value. These measures allow us to determine volumes and relative percentages of recyclable and other valuable materials, and promote 3R (recycle, reuse, reduce) activities.

E Energy: Efficient use of energy

- The Chemical Substance Management System makes it possible to manage controlled substances by simplifying the work of determining amounts of PRTR Law and other controlled substances purchased and used, and assembling data on atmospheric and waterway emissions, and transfers. Furthermore, it helps to reduce chemical substance usage by making it possible to reference purchase data.

T Toxicity: Avoidance of substances that are potentially harmful to the environment

- The Environmental Information Sharing System makes it possible to gather environmental performance data on energy, paper, water, and other resource usage for group companies, including affiliates and overseas group members. Efficiency enhancement and usage reduction are aided by CO₂, fuel, and basic unit data conversions. This system also simplifies preparation of data for inclusion in environmental and CSR reports.

Information & Communication Systems

Optical Network Unit | Mitsubishi Logistics Information System: Dr. Logis
Integrated Environmental Information System

Environmentally Resistant Wide-Area Optical Ethernet Switch

UHF-Band RFID Reader-Writer | WDM Optical Transmission Equipment
Information Equipment Recycling Service

Environmentally Resistant Wide-Area Optical Ethernet Switch MELNET-ES1100

A Slim, Compact Optical Ethernet Switch Suitable for Outdoor Installation

MELNET-ES1100 is ideal for network configurations requiring environmental resistance and large capacity, such as onsite facility surveillance of roads, rivers, dams, erosion control hotspots, ports and harbors, railways, toll roads and other infrastructure, as well as CCTV video coverage equipment.



Optical Ethernet interfaces (1000BASE-X and 100BASE-FX) are mounted with a total of four ports. For each port, a module can be selected based on transmission distance, facilitating long-distance transmission from several kilometers up to 80 kilometers.

To enable outdoor storage (from -10°C to 55°C), MELNET-ES1100's slim, compact 1U rack size (44mm) can be stored within with both JIS and 19-inch racks. In addition, its fanless design eliminates the need for fan replacement or fan filter cleaning.

M Materials: Effective use of resources

- A redesigned heat dissipation mechanism lowers the parts count and reduces weight by 30% compared with conventional models.

E Energy: Efficient use of energy

- Adoption of a low power consumption LSI and other components has reduced power consumption by 14% compared with conventional models.

T Toxicity: Avoidance of substances that are potentially harmful to the environment

- MELNET-ES1100 complies with Lead-free Phase 1 standards (with no lead used in surface treatment of boards and mounting solder) and features vastly reduced overall lead content.

Information & Communication Systems

Optical Network Unit | Mitsubishi Logistics Information System: Dr. Logis
Integrated Environmental Information System
Environmentally Resistant Wide-Area Optical Ethernet Switch
UHF-Band RFID Reader-Writer | WDM Optical Transmission Equipment
Information Equipment Recycling Service

UHF-Band RFID Reader-Writer Ver. 3.0 (RF-RW101)

Factor: 1.631
Performance Factor: 1.000*
Environmental Impact Factor: 1.631
* No performance factor evaluation for this product.

72% More Compact than Conventional Models

Mitsubishi Electric's UHF-band RFID reader-writer can read ID data written on a battery-less tag from a distance of up to 7 meters. Formerly, long-distance ID card systems required battery power, but UHF-band RFID facilitates battery-less operation, enabling the building of systems that are more environmentally compatible.



Detailed equipment data

▶ RF-RW101

M Materials: Effective use of resources

- Overall volume reduced to 72% of conventional models. In addition, recyclable aluminum is utilized in the chassis/packaging material.

E Energy: Efficient use of energy

- Restricting usage to mid-range applications (1-2 meters) cuts the required minimum signal output to 100 mW, compared to 1 W for conventional models, realizing a 60% reduction in power consumption.

T Toxicity: Avoidance of substances that are potentially harmful to the environment

- Compliant with European RoHS Directive.

Information & Communication Systems

Optical Network Unit | Mitsubishi Logistics Information System: Dr. Logis
Integrated Environmental Information System
Environmentally Resistant Wide-Area Optical Ethernet Switch
UHF-Band RFID Reader-Writer | **WDM Optical Transmission Equipment**
Information Equipment Recycling Service

WDM Optical Transmission Equipment 10G x 80 Wavelength ROADM MF-800 GWR



Factor: 31.409
Performance Factor: 21.034
Environmental Impact Factor: 1.496

A Space-Saving Design for 420 Gbit/s in One Bay

Mitsubishi Electric's Reconfigurable Optical Add-Drop Multiplexer (ROADM) is a type of multiple-wavelength transmission equipment that features large-volume data transmission of 10Gbit/s x 80 wavelengths (800Gbit/s). Its single bay can accommodate 42 wavelengths (420 Gbit/s) with ROADM and amplification function cards, thanks to its sophisticated circuit design and device integration, resulting in substantial floor space saving. It is also capable of configuring Add/Drop/Thru for any wavelength from supervisor control terminals installed in operation centers.



These features enable ROADM to provide optimal solutions for network reconstruction, such as through facilities relocation or traffic concentration.

Reasons for Hyper Eco-Product Certification

- Factor 2 or above

Detailed equipment data

- ▶ MF-800GWR

M Materials: Effective use of resources

- In order to enhance degradability and recyclability, the MF-800GWR incorporates appropriate materials and reduced coating.

E Energy: Efficient use of energy

- Advanced components developed in-house have successfully reduced the power consumption per 1 information bit to 4% of that in the year 2000.

T Toxicity: Avoidance of substances that are potentially harmful to the environment

- Designed to comply with European RoHS Directive. Some products are already fully RoHS-compliant; we are currently working toward compliance for all products.

Information & Communication Systems

- Optical Network Unit | Mitsubishi Logistics Information System: Dr. Logis
- Integrated Environmental Information System
- Environmentally Resistant Wide-Area Optical Ethernet Switch
- UHF-Band RFID Reader-Writer | WDM Optical Transmission Equipment
- Information Equipment Recycling Service

Information Equipment Recycling Service

Easy Disposal of Information Equipment

The information equipment recycling service has a Web-based menu for the collection and recycling of used information equipment. Customers can request estimates, place orders and monitor progress online.



Information Equipment Recycling Service Website (Japanese language only)

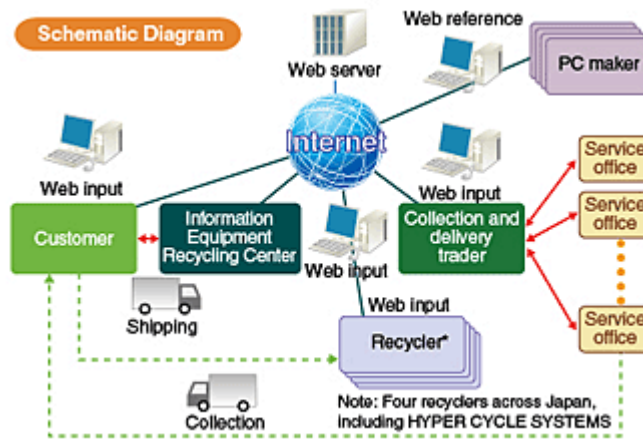

M Materials: Effective use of resources

- To avoid soil, water and air pollution, there is no combustion or washing involved in the recycling process. Recovery and recycling is conducted primarily through disassembling, crushing and separating by hand. The crushing and separation process yields high-grade steel and copper, realizing highly efficient recycling.

Note

Easing Our Customers' Administrative Burden

When disposing of Mitsubishi Electric information equipment*, the customer need not contract with numerous collection and delivery traders and waste disposal organizations. The customer also need not provide or maintain a manifest.

* Mitsubishi Electric information equipment is defined as that manufactured by Mitsubishi Electric Corporation and Mitsubishi Electric Information Technology Corporation as indicated in the table below.

Potential Equipment List

Type	Equipment	
Personal computer	Desktop PC	Notebook PC
Display equipment	CRT display	Liquid crystal display
Workstation	Server workstation (including office computer/mainframe)	
External storage device	Hard disk unit MO disk unit	Floppy disk unit
I/O device	Printer Terminal adapter POS Router	Scanner Modem FAX
Power supply unit	Uninterruptible power supply	

Product Environmental Data

Electronic Devices

In the area of electronic devices, we are working to make critical electronic devices more energy efficient and reduce the use of lead and other controlled substances.



▣ DIP-IPM Module



▣ Laminated Bus Bar

Electronic Devices

DIP-IPM Module | Laminated Bus Bar

Power Module DIP-IPM PS21994

Factor 2.466: Performance Factor 1.50:
Environmental Load Factor 1.644

Power module for driving inverters for home appliances and industrial motors.

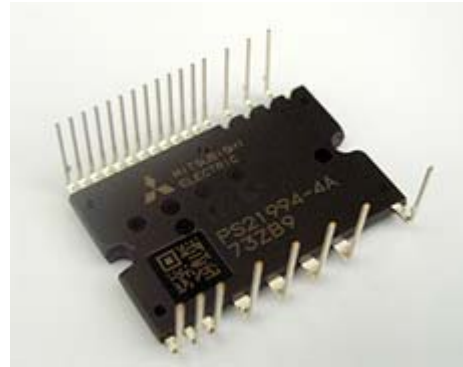

Detailed equipment data

► PS21994

M Materials: Effective use of resources

- Use of a high heat dissipation insulation structure achieved a reduced junction temperature rise in power chips. This allowed for a smaller package and led to a significant reduction (about 40%) of the mounting area on the PCB compared to our current products.

E Energy: Efficient use of energy

- By integrating a full-gate CSTBT™*, which is one of Mitsubishi Electric's advanced IGBTs, electric power consumption in the system was reduced.
- *CSTBT: Carrier Stored Trench Gate Bipolar Transistor

T Toxicity: Avoidance of substances that are potentially harmful to the environment

- Introduction of lead-free process for soldering power chips and plating outer terminals realized all lead-free products (RoHS compliant).

Note

Awarded the 52nd Okochi Prize (Production award)

At the 52nd (2006) Okochi Prize ceremony held on March 14, 2006, the Dual Inline Package-type Intelligent Power Module (DIP-IPM) developed by Mitsubishi Electric's Power Device Works was awarded the Okochi Memorial Foundation Manufacturing Prize for the development and production of a transfer mold intelligent power module. In making its decision, the selection committee praised the development of a highly reliable, low-cost part using a transfer mold to unify multiple power chips, comprising inverter power circuits, with controller ICs. The DIP-IPM is being adopted increasingly for use in not only major appliances using inverters but also for induction heating devices and in the industrial devices market.



Electronic Devices

DIP-IPM Module

Laminated Bus Bar

Laminated Bus Bar (Large Current Circuit Board)

Factor: 2.45

Performance Factor: 2

Environmental Impact Factor: 1.22



Improved Inverter Power Conversion Efficiency and Reduced Weight through use of Aluminum Materials

The laminated bus bar, a large current circuit board, achieves high-speed operation by preventing electrical surges during high-speed switching. The board is used for power semiconductor devices such as IGBTs¹ and IPMs².

Reduced inductance makes it possible for the inverter's main circuit wiring to be completely snubberless. Reduced snubber loss results in improved power conversion efficiency.

Aluminum, rather than copper, is used as the unit's main material, making it more lightweight.

*1 IGBT: Insulated Gate Bipolar Transistor
A semiconductor device used for power control applications

*2 IPM: Intelligent Power Module
A semiconductor device used for ON-OFF switching that contains circuitry for control and protection in a single package

Detailed equipment data

- ▶ Laminated bus bar

M Materials: Effective use of resources

- Achieved a 70% weight reduction by using aluminum rather than copper as the main material

E Energy: Efficient use of energy

- Completely snubberless inverter main circuit wiring
- Significantly improved power conversion efficiency

T Toxicity: Avoidance of substances that are potentially harmful to the environment

- Eliminates six substances indicated by the RoHS Directive (non-applicable).

Home Appliances

In home appliances, we're developing and introducing various products that are energy efficient and make life more comfortable.

NOTE: Many of the products shown on these pages are for the Japanese market only.



▶ Jet Towel Hand Dryer



▶ Hot Water Floor Heating System



▶ Compact Cube for Commercial Use



▶ Room Air Conditioner



▶ Refrigerator



▶ Photovoltaic Module



▶ Photovoltaic Inverter



▶ Eco Cute for Household Use



▶ Eco Cute for Commercial Applications



▶ Ventilator



▶ Energy Recovery Ventilator for Commercial Use



▶ Lossnay Central Ventilator System

Home Appliances

Jet Towel Hand Dryer | Hot Water Floor Heating System
Compact Cube for Commercial Use | Room Air Conditioner | Refrigerator
Photovoltaic Module | Photovoltaic Inverter | Eco Cute for Household Use
Eco Cute for Commercial Applications | Ventilator
Energy Recovery Ventilator for Commercial Use | Lossnay Central Ventilator System

JET TOWEL HAND DRYER JT-SB116GN / JT-SB216GSN



Environmentally conscious product with long life and low power consumption

The Jet Towel Hand Dryer blows off drops of water from the hands with a thin jet of air. As it eliminates paper waste, fewer natural resources are consumed.

* JT-SB116GN is available only in Japan.



Reasons for Hyper Eco-Product Certification

- Factor rating of 2 or more

M Materials: Effective use of resources

- Brushless DC motor has a long life of seven years at up to 1,000 uses per day*.
* Depending upon environment and usage conditions

E Energy: Efficient use of energy

- Approximately 15% lower power consumption compared to previous Mitsubishi Electric model.
(Based on an internal investigation as of February 1, 2007)
- Newly developed "hyper nozzle" improves drying efficiency.

T Toxicity: Avoidance of substances that are potentially harmful to the environment

- Eliminated the use of the six substances specified by the EU's RoHS directive.

Home Appliances

Jet Towel Hand Dryer | **Hot Water Floor Heating System**
Compact Cube for Commercial Use | Room Air Conditioner | Refrigerator
Photovoltaic Module | Photovoltaic Inverter | Eco Cute for Household Use
Eco Cute for Commercial Applications | Ventilator
Energy Recovery Ventilator for Commercial Use | Lossnay Central Ventilator System

"Econucool Pico" Hot Water Floor Heating System VEH-406HCA-κ / VEH-406HCA-M / VEH-406HPU₃



Factor 1.680: Performance Factor 1.22:
Environmental Load Factor 1.478

Econucool Pico: An energy-efficient heat pump-based hot water floor heating system

Econucool Pico heats by sending hot water generated from atmospheric heat to floor heating panels or other types of radiators. This heating system is suitable for fully electric houses which are rapidly gaining in popularity.



Reasons for Hyper Eco-Product Certification

- Factor rating of 1.5 or more
- Fiscal 2008 Energy Savings Award
- Energy Conservation Center Chairman's Award (VEH-406HCA-κ, VEH-406HPU₃)

Detailed equipment data

- ▶ VEH-406HCA-κ

M Materials: Effective use of resources

- Product weight reduced by 67% (36 kg to 12 kg) compared to Mitsubishi Electric's previous model (2001 model) by optimizing the parts layout, making the heat exchanger thinner and reducing the weight of the pump.

E Energy: Efficient use of energy

- We improved heat exchange efficiency by thinning the coolant/water heat exchanger plate and optimizing its shape.
- Rated energy efficiency was improved approximately 30% compared to Mitsubishi Electric's previous model (2001 model) by driving the outdoor fan motor and circulation pump by direct current and by optimizing cooling cycle control.

T Toxicity: Avoidance of substances that are potentially harmful to the environment

- Uses R410A coolant, which does not deplete the ozone layer.
- Eliminated the use of the six substances specified by the EU's RoHS directive.

Note

Econucool Pico reduces energy consumption by some 70-80% compared to water heaters such as gas and oil boilers. The energy saving is the result of using an electric heat pump and a DC pump and automatically varying water temperature and volume. It produces 60°C hot water, which is near to that of a gas boiler. And it is usable at an outdoor temperature of -25°C.

Econucool Pico is being widely used all over Japan, not only in new houses but also as a replacement for old heaters in existing housing.

Heat exchange unit

Outdoor unit

Controller

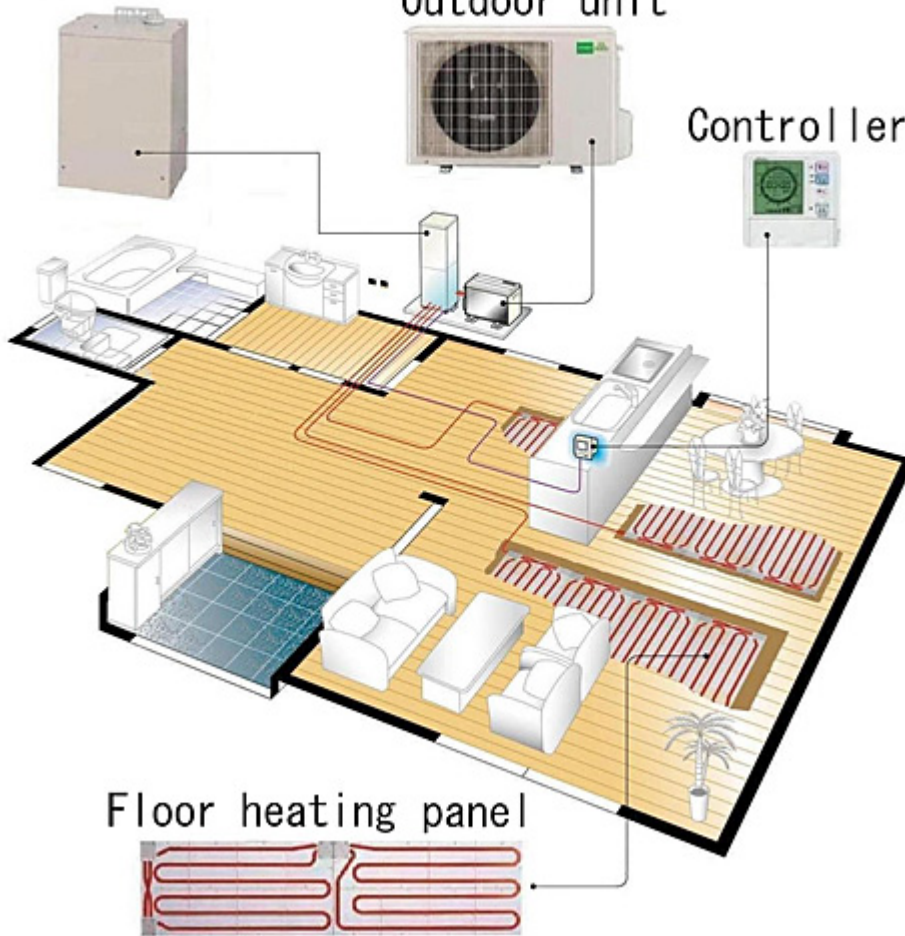

Floor heating panel

System of "Econucool Pico"

Product Environmental Data

Home Appliances

Jet Towel Hand Dryer | Hot Water Floor Heating System
Compact Cube for Commercial Use | Room Air Conditioner | Refrigerator
Photovoltaic Module | Photovoltaic Inverter | Eco Cute for Household Use
Eco Cute for Commercial Applications | Ventilator
Energy Recovery Ventilator for Commercial Use | Lossnay Central Ventilator System

Compact Cube MCHV-P1800AE for Commercial Use

Factor 1.771: Performance Factor 1.00:
Environmental Load Factor 1.771

Lightweight, compact and high part load performance

The Compact Cube is a heat pump chiller that produces cold and hot water used in the air conditioning systems of buildings and factories. The device is driven by electricity, so compared to absorption chillers powered by fuels like gas, the Compact Cube produces cold and hot water while emitting less carbon dioxide.



The Compact Cube features both high efficiency and compactness. It incorporates the following new technologies, which make it ideal not only for new air conditioning systems, but also for converting from existing absorption chillers.

1. New V-flow unit format (an industry first)
2. R410A refrigerant (an industry first for 40+ horsepower chillers)
3. Includes DC inverter-driven scroll compressor (an industry first for 40+ horsepower chillers)
4. New refrigeration cycle with two evaporating temperatures (an industry first)
5. Water dispersion system uses minimal water
6. Improved part load efficiency using COPMAX control (an industry first)

Reasons for Eco-Product Certification

- Factor rating of 1.38 or more

Detailed equipment data

- ▶ MCHV-P1800AE

M Materials: Effective use of resources

- Lighter unit weight, improved performance and fewer resources used thanks to new specifications for the compressor and heat exchanger and a new optimized layout for the unit panels. 24% lighter than the previous Mitsubishi Electric model (2,150 kg→1,640kg).
*Previous model: CAH-J 1800A (60 Hz) used for comparison

E Energy: Efficient use of energy

- Superior energy efficiency due to improved efficiency of devices that make up the unit, including the compressor, heat exchangers and airflow fans, and more sophisticated refrigeration cycle control.
- Cooling COP raised by 66% compared to the previous Mitsubishi Electric model (2.59→4.3).
- Heating COP raised by 17% compared to the previous Mitsubishi Electric model (3.29→3.85).
*Previous model: CAH-J1800A (60 Hz) used for comparison

T Toxicity: Avoidance of substances that are potentially harmful to the environment

- Product uses HFC refrigerant R410A, eliminating ozone-depleting substances (previous Mitsubishi Electric model uses HFC refrigerant R22).
- Eliminated the use of the six substances specified by the EU's RoHS directive.
*Previous model: CAH-J1800A (60 Hz) used for comparison

Note

The Compact Cube air-cooled heat pump chiller achieves a high rated cooling efficiency of COP 4.8 (40 horsepower model) as a result of optimized heat exchangers and its water dispersion method. Use of an inverter-driven scroll compressor provides energy efficiency throughout the year, not just during rated operating hours. Converting from an absorption chiller would reduce carbon dioxide emissions by 58% and power consumption by 48%.

Compact Cube's small size was achieved through high-density mounting of the heat exchangers. It is the lightest chiller in the industry in the 180 kilowatt class (cooling capacity).

The product's high energy-efficient performance was recognized and it was awarded the Energy Conservation Center Chairman's Award at the Fiscal 2008, 19th Energy Savings Awards.

Home Appliances

Jet Towel Hand Dryer | Hot Water Floor Heating System
 Compact Cube for Commercial Use | **Room Air Conditioner** | Refrigerator
 Photovoltaic Module | Photovoltaic Inverter | Eco Cute for Household Use
 Eco Cute for Commercial Applications | Ventilator
 Energy Recovery Ventilator for Commercial Use | Lossnay Central Ventilator System

Room Air Conditioner ZW Series (MSZ-ZW400S)



Factor 2.541
 Performance Factor 1.145
 Environmental Load Factor 2.219

"Notice Navi" Function to Encourage Energy-Saving Operation

Mitsubishi Electric's proprietary Move Eye, an eight-element infrared sensor, analyzes various room conditions, such as floor and wall temperatures and people's locations. The "Notice Navi" function provides the user with energy-saving advice, such as "Closing the curtains and doors would help save energy," providing appropriately timed conservation tips on easy-to-overlook points. The energy efficiency of the air conditioner itself, plus the effects of the energy-saving tips it provides users put this unit at the forefront of the ecologically conscious generation.

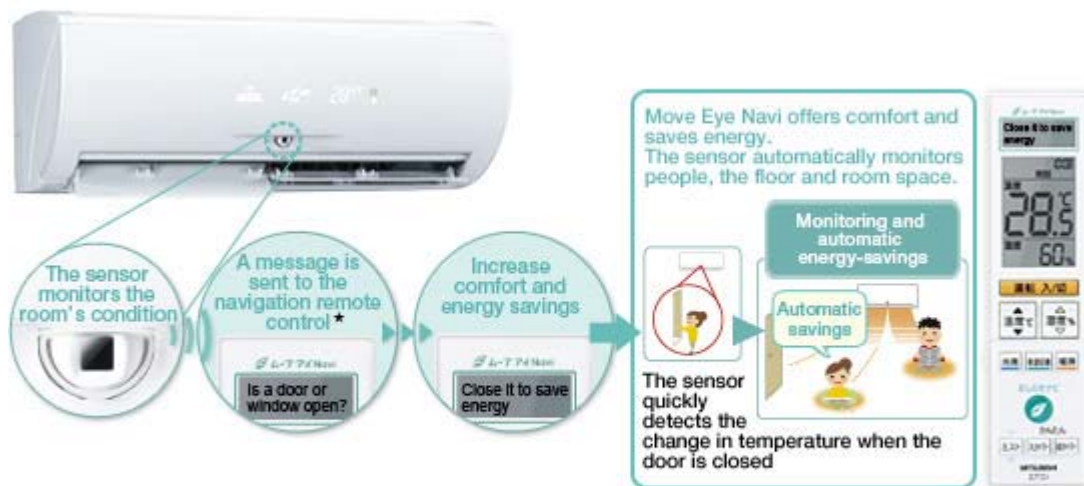

* Move Eye detects temperature differences on the floor, walls and from windows and doors. When temperature differences are minimal, or there is no impact in terms of saving energy, no messages are sent even when windows and doors are open.

Reasons for Hyper Eco-Product Certification

- Employs independent sensors, using "Notice Navi" function to provide energy-saving tips to users
- Employs Mitsubishi Electric's proprietary self-circulating recycling technology to maximize the use of recycled plastic
- Factor 2 or higher

Detailed equipment data

- ▶ MSZ-ZW400S

- Our selection technology allows three major types of plastic to be separated, with a high degree of purity, from the mixed plastic that results from end-of-life home appliances. Self-circulating recycling technology is used for interior parts to maximize the use of recycled plastic.
- This unit employs a proprietary hydrophilic/hydrophobic coating on metal and plastic parts that are inside the room, effectively repelling hydrophilic contaminants, such as lint and dust, and hydrophobic contaminants, such as greasy smoke. This function reduces the adhesion of contamination to 1/10 the normal level. A automatic filter-cleaning function, combined with the energy savings and reduced deterioration that results from low internal contaminant levels contributes to the long life of the unit.
- Existing piping can be reused, substantially lowering emissions.

E Energy: Efficient use of energy

- Improved efficiency of key air conditioner devices, such as the condenser, heat exchange and fan motor, puts this unit at the top of its class industrywide in terms of energy conservation.
- The Move Eye senses floor and wall temperatures, as well as people's locations and movements, and automatically adjusts its direction and temperature according to individual body temperatures. In this manner, the unit maintains a high degree of comfort while achieving an energy savings of up to 65%.
- The "Notice Navi" function provides energy-saving advice during operation and encourages user awareness of energy savings through visual remote control displays showing the amount of electricity being used by the indoor unit, CO₂ emissions and electricity use during energy-saving operating mode.

T Toxicity: Avoidance of substances that are potentially harmful to the environment

- Emits no substances defined in the EU RoHS directive, Japanese Industrial Standards (JIS) or J-Moss.

Home Appliances

Jet Towel Hand Dryer | Hot Water Floor Heating System
 Compact Cube for Commercial Use | Room Air Conditioner | Refrigerator
 Photovoltaic Module | Photovoltaic Inverter | Eco Cute for Household Use
 Eco Cute for Commercial Applications | Ventilator
 Energy Recovery Ventilator for Commercial Use | Lossnay Central Ventilator System





Refrigerator MR-E50R



Factor 2.8

Using the Power of Light (LEDs) to Prevent Frost Formation and Discoloration during Frozen Storage

While continuing to offer the flash freezing that keeps food delicious in frozen storage, these products use the power of light to prevent frost formation and discoloration, as well as bacteria and smells. An Eco-Monitor indicates operating conditions by displaying a number of leaves (zero to three), encouraging an awareness of energy conservation.

Standard operation*	Approximately 5% energy savings	Approximately 10% energy savings
 ECO Monitor	 ECO Monitor	 ECO Monitor
<p>Evaluates temperature settings, frequency that doors are opened and closed and overall refrigerator operating conditions.</p> <p><small>* When settings are: refrigerator (medium), freezer drawer (medium) and versa drawer (set to soft freeze, medium) (may vary depending on conditions of use and ambient temperatures)</small></p>		
		<p>Nanoporous cooler for efficient defrosting time</p>

Reasons for Hyper Eco-Product Certification

- Factor rating of 2 or more
- Maximizes Use of Self-Circulated Recycled Plastics and Recycled Resources
- Industry Leader in Its Class for Energy Conservation and Quiet Operation

Detailed equipment data

- ▶ MR-E50R

M Materials: Effective use of resources

- Refrigerator parts are reused by promoting self-recirculated recycling of plastic (polypropylene, polystyrene) from end-of-life refrigerators at home appliance recycling plants.

E Energy: Efficient use of energy

- The unit employs a nanoporous condenser, which employs condenser fins that are porous to increase surface area, making frost formation more uniform. Condenser pipes employ heaters externally (radiant heater) and internally (aluminum pipe heater). This use of hybrid defrost heaters raises efficiency and conserves energy during defrosting.

* Radiant heater: Heater that uses nichromium wires as heat sources

T Toxicity: Avoidance of substances that are potentially harmful to the environment

- Does not use any substances governed by the EU's RoHS Directive or J-Moss substances regulated by Japan Industrial Standards.

Product Environmental Data

Home Appliances

Jet Towel Hand Dryer | Hot Water Floor Heating System
Compact Cube for Commercial Use | Room Air Conditioner | Refrigerator
Photovoltaic Module | Photovoltaic Inverter | Eco Cute for Household Use
Eco Cute for Commercial Applications | Ventilator
Energy Recovery Ventilator for Commercial Use | Lossnay Central Ventilator System

Photovoltaic Module

PV-TJ235GA6 (for Europe) / PV-UJ235GA6 (for North America, Asia)

Factor: 1.73
Performance Factor: 1.865
Environmental Load Factor: 0.928

Using four bus bar cells with an expanded module size, we have achieved a maximum output of 235W per module.



Reasons for Eco-Product Certification

- Environmentally effective product
- Factor rating of 1.5 or more

Detailed equipment data

- ▶ PV-TJ235GA6

M Materials: Effective use of resources

- Width of new bus bars used in the cell is half that of our previous bus bars, delivering greater efficiency without increasing the amount of material used.
- Optimized frame design approximately doubles the strength of our previous frame.

E Energy: Efficient use of energy

- Individual cell output improved by adopting four bus bar cells.
- Module size expanded to increase output per module.

T Toxicity: Avoidance of substances that are potentially harmful to the environment

- Uses lead-free solder to lessen impact on the environment.

Note

- By increasing the number of bus bars from two to four, the internal resistance in each PV cell has been reduced, increasing individual cell output by 3 percent compared to those used in our previous models.
* When comparing our 2-bus-bar cell.
- The number of cells per module has also increased from 50 to 60. This increase, combined with the new four bus bar cells raised power by as much as 24%, compared to our previous models.
* When comparing our 190W model to the new 235W model.
- The newly designed frame, which is approximately twice as strong as our previous frame, enables the module to pass the IEC61215 (2nd Ed.) static load test of 5400Pa despite the larger module size.

Product Environmental Data

Home Appliances

Jet Towel Hand Dryer | Hot Water Floor Heating System
Compact Cube for Commercial Use | Room Air Conditioner | Refrigerator
Photovoltaic Module | **Photovoltaic Inverter** | Eco Cute for Household Use
Eco Cute for Commercial Applications | Ventilator
Energy Recovery Ventilator for Commercial Use | Lossnay Central Ventilator System

Photovoltaic (PV) Inverter PV-PNS04ATL-GER



Factor 2.33: Performance Factor 2.105:
Environmental Load Factor 1.107

Mitsubishi Electric PV inverters for photovoltaic power systems feature industry-class maximum power conversion efficiency of 96.2% and maximum input voltage of 700 volts.



Reasons for Hyper Eco-Product Certification

- Environmentally effective product
- Factor rating of 2 or more

Detailed equipment data

- ▶ PV-PNS04ATL-GER

E Energy: Efficient use of energy

- Generated power is used effectively with 96.2% power conversion efficiency.

T Toxicity: Avoidance of substances that are potentially harmful to the environment

- Eliminated the use of the six substances specified by the EU's RoHS directive.

Note

Mitsubishi Electric has developed a new power module for PV inverters sold in Europe. The internal circuitry uses a new system called the "three level inverter system*" (patent pending), and the filter that adjusts the waveform of the outputted current uses a reactor made of a new material (ferrite core), which stands up to high output and produces minimal loss. Optimally controlling these components has resulted in an industry-class maximum power conversion efficiency of 96.2%.

* This method reduces loss by switching between high voltage, medium voltage and low voltage.



Cooling structure for long-term reliability and high efficiency.



Large-size displays, enhanced by multiple-indicators with green colored backlight.



Safety enclosure with dust-tight structure.

Product Environmental Data

Home Appliances

Jet Towel Hand Dryer | Hot Water Floor Heating System
Compact Cube for Commercial Use | Room Air Conditioner | Refrigerator
Photovoltaic Module | Photovoltaic Inverter | **Eco Cute for Household Use**
Eco Cute for Commercial Applications | Ventilator
Energy Recovery Ventilator for Commercial Use | Lossnay Central Ventilator System

Eco Cute (Heat Pump Water Heater) for Household Use SRT-HP46W4

Factor: 2.777
Performance Factor: 2
Environmental Impact Factor: 1.388

Eco Cute: Contributing to Households and the Environment

Mitsubishi Electric's SRT-HP46W4 Heat Pump Water Heater makes use of ambient heat in the air to attain energy savings of one-third compared with Mitsubishi Electric's conventional electric water heaters. As this model uses natural CO₂ as a refrigerant, it causes no damage to the ozone layer and has a global warming potential 1/1700 of that posed by CFC refrigerants. Moreover, it does not produce CO₂ emissions because it does not require the combustion of fuel.



Detailed equipment data

► SRT-HP46W4

M Materials: Effective use of resources

- The hot water tank unit has a lower parts count; the use of plastic piping components has made the product more lightweight.
- The heat pump unit's revamped heat exchanger and simplified internal configuration reduces both weight and size.
- The use of thinner cardboard helps to reduce the amount of packaging materials.

E Energy: Efficient use of energy

- Annual water heating efficiency of 3.3
 1. The SRT-HP46W4 incorporates an original rotary compressor for CO₂ refrigerant hot-water supply.
 2. The use of a torsional pipe for the water side of the heat exchanger and brazing of the twisted refrigerant pipe increases heat exchange capacity.
 3. Redesign of the expansion circuit optimizes refrigerant flow and enhances heat exchange efficiency.
 4. Expanded polystyrene (EPS) is used as an insulating material up to the top of the hot-water storage tank.

T Toxicity: Avoidance of substances that are potentially harmful to the environment

- No RoHS-restricted substances are used. (Employs lead-free solder boards, trivalent chrome plating and other technologies).

Note

A heat pump unit that realizes high operational efficiency

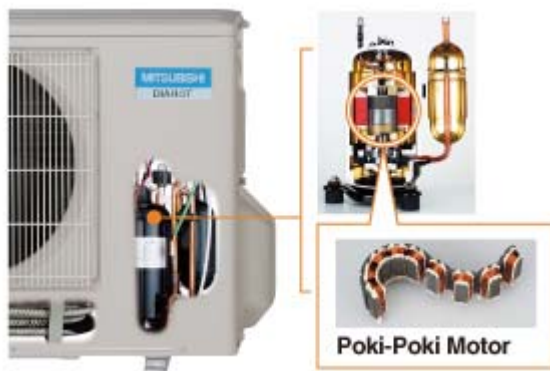

The heat pump unit features a proprietary rotary compressor* for CO₂ refrigerant hot-water supply. Moreover, it incorporates Mitsubishi Electric's unique open core coil-wound "Poki Poki Motor." This high-density coil technology helps realize significant performance improvements.

*The high-efficiency rotary compressor received the FY2008 Technology Prize of the Japan Society of Refrigerating and Air Conditioning Engineers

A hot-water storage tank featuring improved construction and durability

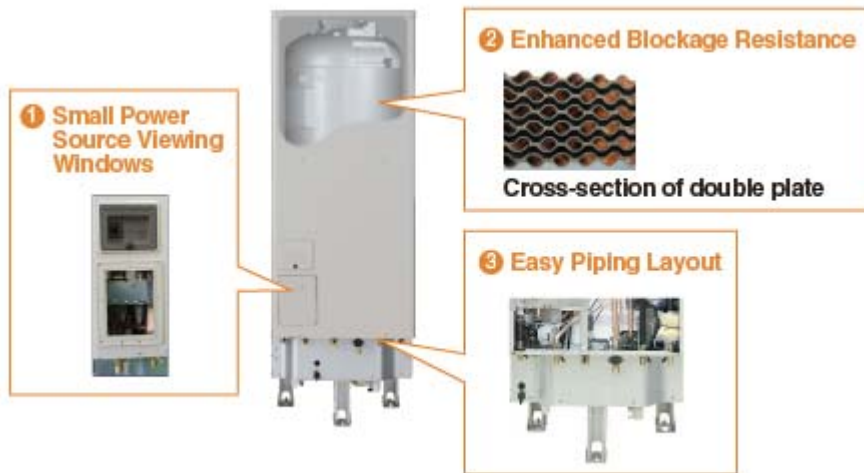

- 1. Small Power Source Viewing Windows**
Small viewing apertures on the front of the console facilitate power source work and remote line construction without removing the cover.
- 2. Enhanced Blockage Resistance**
While employing a high-efficiency plate, the bathtub circuit uses large-diameter piping for better blockage resistance.
- 3. Easy Piping Layout**
The piping connections are located 400 mm off the ground (200 mm stand + 200 mm kick plate) to facilitate piping even with difficult-to-bend polyethylene. Piping connectors are located at least 80mm apart to facilitate attachment and removal of insulating materials.

A smart remote control facilitates intelligent viewing and usage



1. A large backlit LCD enables easy viewing, even in dark locations.
2. "One button one function" operation allows various simple settings, such as hot water volume and temperature.
3. A transparent plastic panel is employed on the remote control for higher quality.

Home Appliances

Jet Towel Hand Dryer | Hot Water Floor Heating System
Compact Cube for Commercial Use | Room Air Conditioner | Refrigerator
Photovoltaic Module | Photovoltaic Inverter | Eco Cute for Household Use
Eco Cute for Commercial Applications | Ventilator
Energy Recovery Ventilator for Commercial Use | Lossnay Central Ventilator System

Eco Cute (Heat Pump Water Heater) for Commercial Applications QAHV-N560B

Factor: 1.77
Performance Factor: 1.00*
Environmental Impact Factor: 1.77
* No performance factor evaluation for this product.



Hot Water Supply that Enhances Ease of Living

With a newly developed inverter-type scroll CO₂ compressor, the QAHV-N560B achieves a COP rating of 4.1 and significantly reduces hot water supply running costs. The CO₂ heat pump and inverter capacity control technologies facilitate an optimum hot water output of up to 90°C.

Received 10th Electric Load Leveling System Award
Received Ministry of Economy, Trade and Industry, Agency for Natural Resources and Energy Director-General's Prize

Detailed equipment data

▶ QAHV-N560B

M Materials: Effective use of resources

- Heat storage is carried out during nighttime using the hot water tank, facilitating electrical energy load leveling.

E Energy: Efficient use of energy

- Thermal energy absorbed from the atmosphere heats the water that passes through the heat exchanger. The system produces approximately three to four times the amount of electrical energy used (high efficiency).

T Toxicity: Avoidance of substances that are potentially harmful to the environment

- The natural refrigerant (CO₂) used by the QAHV-N560B has an ozone depletion potential of zero and a global warming potential of one. The volume of CO₂ emissions is 40% lower than that of a combustion-based boiler, and the generation of NO_x and other noxious substances is reduced.

Home Appliances

Jet Towel Hand Dryer | Hot Water Floor Heating System
Compact Cube for Commercial Use | Room Air Conditioner | Refrigerator
Photovoltaic Module | Photovoltaic Inverter | Eco Cute for Household Use
Eco Cute for Commercial Applications | **Ventilator**
Energy Recovery Ventilator for Commercial Use | Lossnay Central Ventilator System

Ventilator V-08PX₆, V-08PD₆ (for Japanese market only)



Factor 1.87: Performance Factor 1.21:
Environmental Load Factor 1.54

These compact ventilators are equipped with high-performance, compact motors ("minimo") for improved performance and energy efficiency.



Reasons for Hyper Eco-Product Certification

- Received the Agency for Natural Resources and Energy Director General's Prize at the Energy Conservation Grand Prize
- Resource conservation achieved through the use of a compact motor

Detailed equipment data

- ▶ V-08PD₆

M Materials: Effective use of resources

- Equipped with the "minimo" compact motor, which is 70% smaller and lighter than previous motors.

E Energy: Efficient use of energy

- Increased ventilation air volume by at least 25% by expanding air passageways.
- Up to 30% energy savings from high-density windings based on a structure of separate winding frameworks.

T Toxicity: Avoidance of substances that are potentially harmful to the environment

- Eliminated the use of the six substances specified by the EU's RoHS directive.

Note

Received the Agency for Natural Resources and Energy Director General's Prize at the Energy Conservation Grand Prize

The V-08PX₆, and 15 other ventilator models, all equipped with the "minimo" compact motor, were named winners of the Agency for Natural Resources and Energy Director General's Prize at the Energy Conservation Grand Prize.

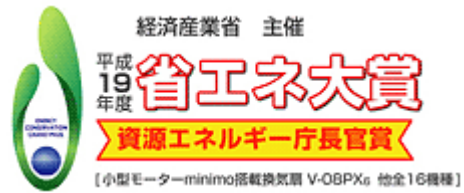

Model Name	Frequency (Hz)	Power consumption (W)	Net supply airflow (m ³ /h)*1	Air volume per unit of power consumption (m ³ /h/W)
"minimo"-equipped product V-08PX ₆	50	1.8	66.5	36.9
	60	2.2	74.5	33.9
Conventional ventilator V-08PX ₅	50	2.3	55.0	23.9
	60	2.4	64.0	26.7

*1 Air volume when installed with pipe of approximately 6.5m in length.

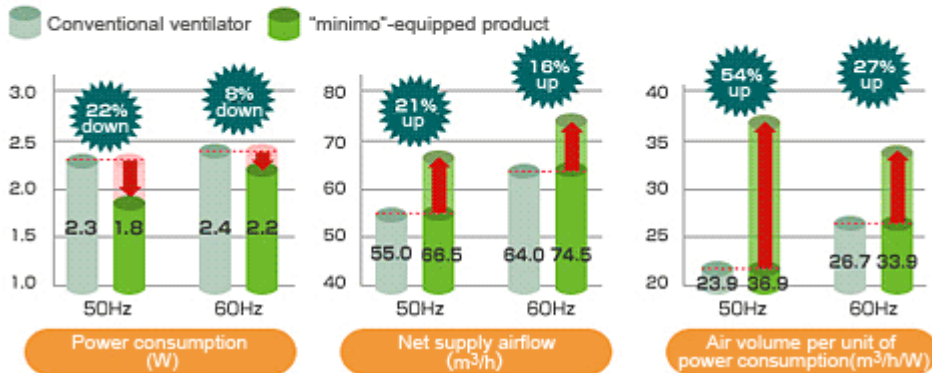

Home Appliances

Jet Towel Hand Dryer | Hot Water Floor Heating System
Compact Cube for Commercial Use | Room Air Conditioner | Refrigerator
Photovoltaic Module | Photovoltaic Inverter | Eco Cute for Household Use
Eco Cute for Commercial Applications | Ventilator
Energy Recovery Ventilator for Commercial Use | Lossnay Central Ventilator System

Energy Recovery Ventilator (LOSSNAY) LGH-50RX5-E for Commercial Use



Factor: 2.73
Performance Factor: 2.40
Environmental Impact Factor: 1.14



Equipped with the Hyper Eco Core, which delivers a total heat exchange efficiency of 66.5%, the LGH-50RX5-E is an Energy Recovery Ventilator that is both environmentally conscious and energy efficient. Thanks to the new ventilation pattern function, this product offers more precise control of ventilation to reduce the air conditioning/heating load caused by ventilation.

Reasons for Hyper Eco-Product Certification

- Environmentally effective product
- Factor rating of 2 or more

M Materials: Effective use of resources

- Fewer parts, fewer screws, thinner sheet metal.

E Energy: Efficient use of energy

- Total heat exchange efficiency of 66.5%.

T Toxicity: Avoidance of substances that are potentially harmful to the environment

- Eliminated the use of the six substances specified by the EU's RoHS directive.

Note

With the Hyper Eco Core, a new heat exchanger (Lossnay Core), this ventilator delivers total heat exchange efficiency of 66.5%, which is the leading position in the market. Keeping air conditioning/heating losses to a minimum, the 50RX5-E can save expenses in annual air conditioning/heating compared to a ventilator that simultaneously takes in and exhausts air. In addition, this product offers more flexible operation for individual days through its weekly timer function, while the Extra Low Mode makes it possible to implement 24-hour energy conservation ventilation. These functions provide more precise control of air volume, yielding much better energy-saving ventilation. Moreover, during the summer season, the Night Purge function draws cooler outside air into the room to reduce the load when the air conditioning is started the next morning, thereby boosting energy efficiency.

Home Appliances

Jet Towel Hand Dryer | Hot Water Floor Heating System
Compact Cube for Commercial Use | Room Air Conditioner | Refrigerator
Photovoltaic Module | Photovoltaic Inverter | Eco Cute for Household Use
Eco Cute for Commercial Applications | Ventilator
Energy Recovery Ventilator for Commercial Use | **Lossnay Central Ventilator System**

Lossnay Central Ventilator System VL-20ZMH3-L/-R

Factor: 2.207
Performance Factor: 1.206
Environmental Impact Factor: 1.83

A Ventilator System that Recovers Heat from Cooling and Heating Energy Using a Heat Exchanger

The Lossnay Central Ventilator System uses separate ducts to intake outdoor air and to discharge indoor air to the outside. Heat exchange is carried out between the ducts as the system ventilates the entire household. This product incorporates DC brushless motors powered by a direct current power source on both the air intake and discharge sides, significantly reducing power consumption compared with conventional models. In addition, the Hyper Eco Element heat exchanger greatly boosts heat exchange efficiency to realize even further energy savings.

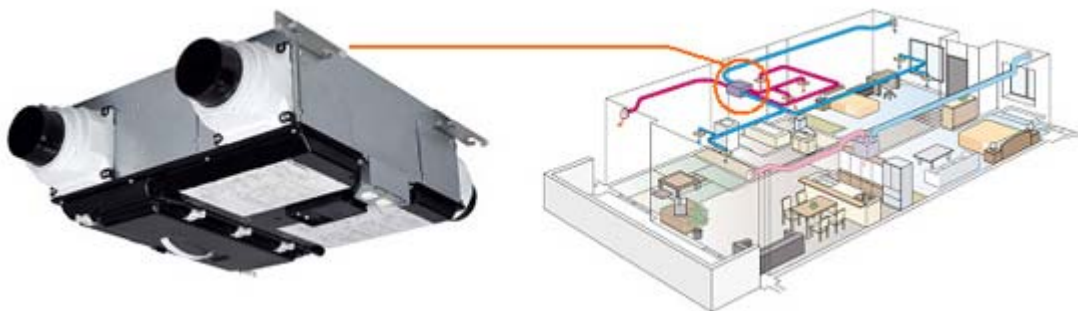

Detailed equipment data

▶ VL-20ZMH3-L/-R

E Energy: Efficient use of energy

- Lossnay is an energy-saving ventilation system that recycles cooling and heating energy (heat recovery) by means of a heat exchanger. The Lossnay Central Ventilator System is a single unit that ventilates an entire household. The heat exchanger ensures ventilation without sacrificing the comforts of cooling and heating, and its high wind flow ensures that even in large housing complexes and cluster housing with numerous rooms, a single system suffices for one floor.

T Toxicity: Avoidance of substances that are potentially harmful to the environment

- Eliminated the use of the six substances specified by the EU's RoHS directive.

Note

Both the air intake and discharge ducts are mounted with DC brushless motors powered by a direct current power source, which significantly reduces power consumption compared with conventional Mitsubishi Electric models mounted with AC motors.

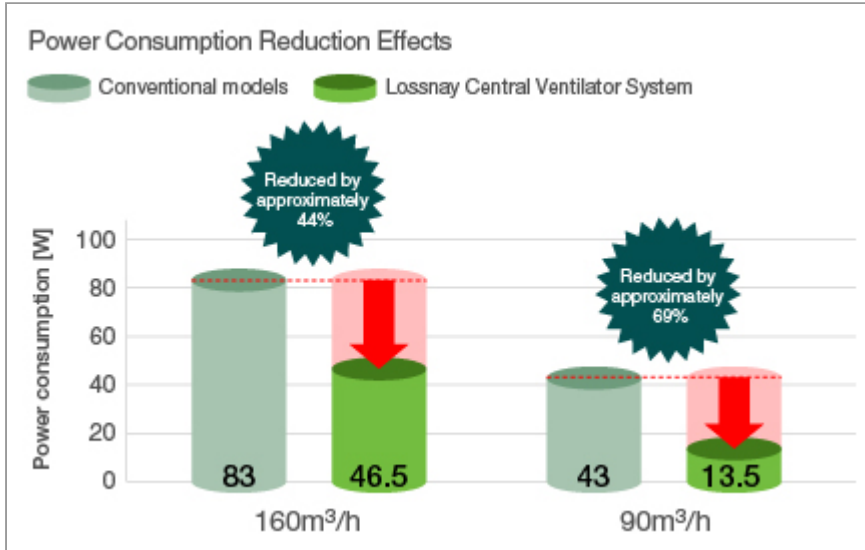

The Lossnay Central Ventilator System realizes a significantly higher relative power consumption* than existing Mitsubishi Electric models, even when driving the required 1 m³/h air feed.

* Relative power consumption [W/(m³/h)] = ventilator power consumption [W]/ventilator air flow [m³/h]

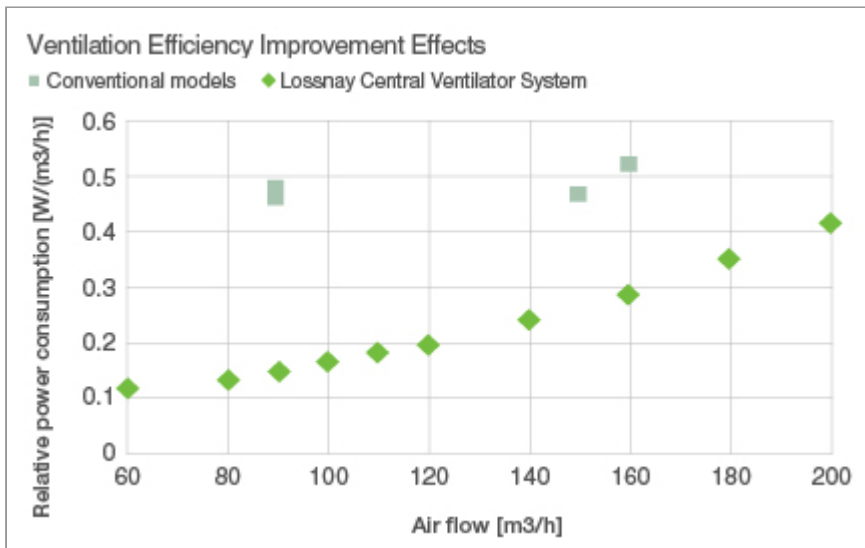

Environmental Report

Environmental Contribution in Business



▶ Environment-Related Business

Reducing CO₂ through Business Activities
Photovoltaic Systems Business
Heat Pump-Related Business
Power Devices Business

▶ Reducing CO₂ from Power Generation

Initiatives to further reduce the environmental
impact of

- 1) High-efficiency power generation
equipment
- 2) Clean power generation facilities
- 3) Electric power infrastructure equipment

Environment-Related Business

Reducing CO₂ through Business Activities

Overview of the Mitsubishi Electric Group's initiatives to contribute to the creation of a low-carbon society by positioning environment-related business as a pillar of growth and by providing energy-saving products.

Photovoltaic Systems Business

We're expanding our business with the goals of cutting emissions by the equivalent of 350,000 tons of CO₂, and achieving 250 billion yen in sales in fiscal 2016.

Heat Pump-Related Business

We're expanding our business with the goals of cutting emissions by the equivalent of 750,000 tons of CO₂, and achieving 800 billion yen in sales in fiscal 2016.

Power Devices Business

We're expanding our business with the goals of cutting emissions by the equivalent of 4,000,000 tons of CO₂, and achieving 150 billion yen in sales in fiscal 2016.

Environment-Related Business

Reducing CO2 through Business Activities

Environment-Related Business
6th Environmental Plan (FY2010-FY2012) (FY2016 Targets)
Aiming to Achieve ¥1.3 Trillion in Net Sales in FY2016

The Mitsubishi Electric Group is targeting a reduction in CO2 emissions from product usage by 30% as outlined in its Environmental Vision 2021.

In moving towards this goal, Mitsubishi Electric has positioned environment-related business as a key pillar of growth, and is contributing to the creation of a low-carbon society through providing a variety of energy-efficient and energy-saving products, including photovoltaic systems, power devices, high-efficiency automotive equipment, energy conservation and support equipment, high-efficiency lighting, energy-efficient building equipment, home electronics recycling, heat pumps and clean energy solutions.



Environment-Related Business

Photovoltaic Systems Business

Photovoltaic Systems Business Expansion Plan

Mitsubishi Electric's photovoltaic systems business primarily focuses on PV modules, which convert photovoltaic energy into electrical energy, and PV inverters, which convert generated power into electricity for the home. We develop and manufacture both PV modules and PV inverters at our own facilities, and have established a strong track record as a manufacturer that can market high-efficiency total system solutions.

Mitsubishi Electric is also among the top in the industry in terms of conversion efficiency for polycrystalline PV cells and conversion efficiency for PV inverters. We are able to provide a full range of high-efficiency product solutions for large-scale applications in both residential and commercial markets.

Leveraging these strengths and leading technologies, we are moving forward with ambitious plans to expand our photovoltaic systems business, with the goal of 250 billion yen in sales, and a reduction in emissions equivalent to 350,000 tons of CO₂, in fiscal 2016.

[Click here for examples of photovoltaic system installations](#)

Fiscal 2010 Results

Expanding Operations by Enhancing R&D and Production Structures

Although government support helped the Japanese domestic market show modest growth in fiscal 2010, sales in overseas markets slowed considerably on the back of the global economic slowdown. Despite these challenging conditions, we are moving forward with plans to expand our photovoltaic systems business by improving power generation efficiency and production efficiency, and by developing the enhanced production structure needed to respond to future increases in demand.

Our R&D achievements in fiscal 2010 include a 19.3%¹ photoelectric conversion efficiency for our 15 cm x 15 cm, 200 μ m-thick polycrystalline silicon PV cell, establishing a new "world's highest"² record for the third consecutive year), and a world-leading 18.1%¹ conversion efficiency for our ultra-thin 15cm x 15 cm, 100 μ m-thick polycrystalline silicon PV cell. In addition, our thin-film silicon PV cell achieved an industry-leading 14.8%³ conversion efficiency.

In fiscal 2011 we will expand our annual production capacity from 220 megawatts to 270 megawatts and launch production of monocrystalline modules. Following this, while closely monitoring market trends, we will carry out facility upgrades to establish an annual production capacity of 600 megawatts after fiscal 2012.

- 1 Measurement provided by the Research Center for Photovoltaics, National Institute of Advanced Industrial Science and Technology.
- 2 Mitsubishi Electric research as of February 16, 2010.
- 3 Mitsubishi Electric measurement (5mm x 5mm - sized cell, initial efficiency rate)

Fiscal 2010 R&D Achievements (1)

World-leading Photoelectric Conversion Efficiency for both Polycrystalline Silicon PV Cell and Ultra-thin Polycrystalline Silicon PV Cell

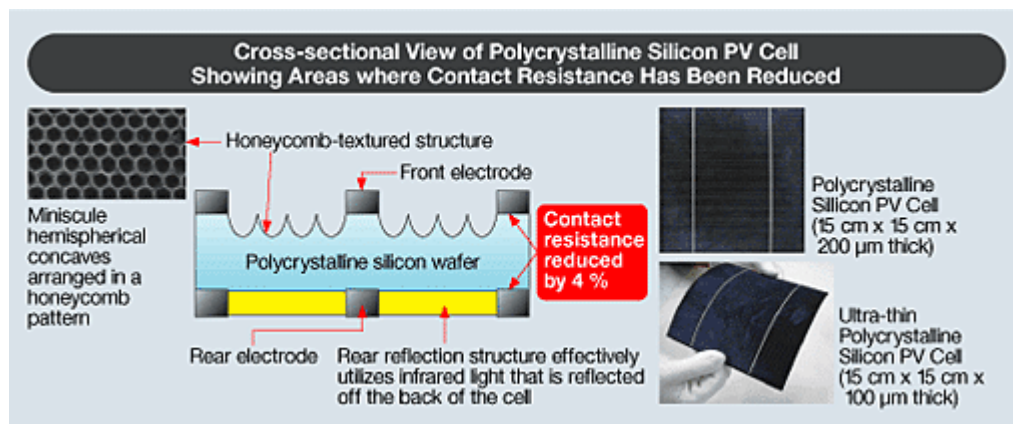

Mitsubishi Electric has applied an ultrafine honeycomb structure with hemispherical indentations that reduces reflection off the cell surface to a minimum. In addition to innovations for light absorption on the surface of the cell, Mitsubishi Electric successfully developed a back surface reflection structure which effectively utilizes infrared light that passes through the cell by reflecting it, enabling the cell to collect a larger amount of solar light.

Fiscal 2010 R&D Achievements (2)

Thin-film Silicon PV Cell with Industry-leading Photoelectric Conversion Efficiency

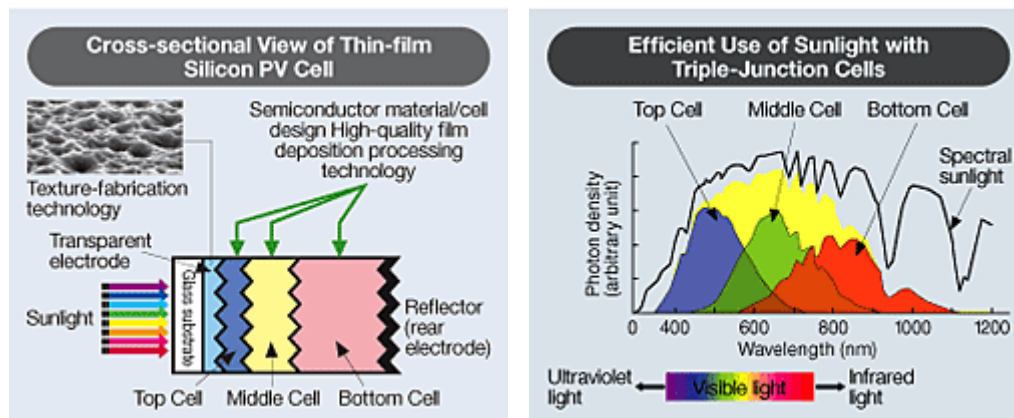

Thin-film silicon PV cells, which use only 1% of the silicon of crystalline-type PV cells, greatly contribute to resource conservation. Mitsubishi Electric has developed a proprietary triple-junction structure PV cell with stacked electricity generation layers that absorb sunlight over a wide spectrum of wavelengths. Moving forward, we will continue our development efforts to make this product commercially viable in the future.

Environment-Related Business

Heat Pump-Related Business

Heat Pump-Related Business Expansion Plan

A heat pump is a system that releases heat into the surrounding area when its refrigerant changes phase from a gas to a liquid (heating) and removes heat from its surroundings when the refrigerant changes phase from a liquid to a gas (cooling). This process is achieved without combustion, and can generate between three to six times more heat energy than the amount of electricity it consumes, greatly reducing CO₂ emissions. For these reasons, heat pumps are considered a sustainable energy technology in Europe.

Mitsubishi Electric developed the "City Multi Zubadan" the world's first multi air conditioner for buildings that is capable of acting as a heat source in outside air temperatures as low as -25° C. Mitsubishi Electric is working to improve the performance of key components used in such units, namely the compressor and heat exchanger, and expand its heat pump-related business, including room air conditioners, package air conditioners and water heater equipment, throughout the world. Mitsubishi Electric's strength lies in its world-leading development, technological and production expertise related to compressors, which are key parts in heat pumps systems. In addition, we offer a wide range of total solutions for homes, buildings and retail stores.

Leveraging these strengths, Mitsubishi Electric is aiming to expand its heat pump-related business with the target of achieving 800 billion yen in net sales and reducing emissions by the equivalent of 750 thousand tons of CO₂ in fiscal 2016.

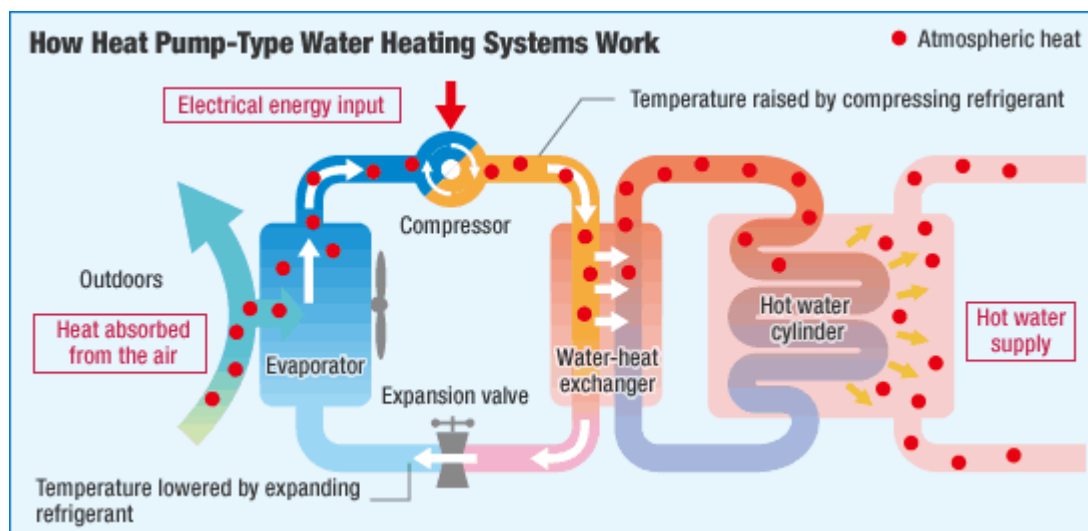



Heat Pump-Related Business Expansion Plan

Fiscal 2010 Achievements

Room air conditioners

Sales of single room air conditioners faced an uphill battle in Japan due to irregular weather patterns and mild summer temperatures in fiscal 2010. In fiscal 2011 Mitsubishi Electric is planning to achieve higher sales by introducing a new model that won a national energy saving award, and by appealing to the growing environmental consciousness of consumers. We will also take steps to strengthen our production and sales infrastructures internationally to accelerate the global growth of sales.

Package air conditioners

Sales of package air conditioners fell year-on-year as building starts slowed amid the global economic downturn. We will work to expand sales in fiscal 2011, capitalizing on replacement demand for high efficiency devices spurred by the revision of the Rationalization in Energy Use Law in Japan, and on growing environmental awareness globally.

Air-to-water heat pumps

Although the air-to-water heat pump segment in Europe also had slow growth in fiscal 2010 due to the economic slowdown, we believe demand will recover from fiscal 2011 and are steadily developing our sales infrastructure and enhancing our product lineup with new items.

Energy savings through integration of diverse technologies

Looking ahead, Mitsubishi Electric will further leverage its synergies as a comprehensive electric and electronics manufacturer and a major provider of digital televisions, lighting fixtures, ventilation fans, and all-electric devices including photovoltaic systems, EcoCute, induction heating cook tops, and heat pump in-floor radiant heating systems. We will further enhance our technologies to boost the energy-saving performance of our products, and combine these components into integrated building systems that offer energy conservation and contribute to the realization of a low-carbon society.

Environment-Related Business

Power Devices Business

Power Device Business Expansion Plan

Power devices control the efficient use of electricity and are installed in a variety of products from home electronics to industrial machinery. With rising demand for technologies that improve energy efficiency and conservation, it is becoming increasingly important to improve the performance of power devices.

As such, Mitsubishi Electric is aiming to expand its power device business to achieve net sales of 150 billion yen and reduce emissions by the equivalent of 4 million tons of CO₂ in fiscal 2016.

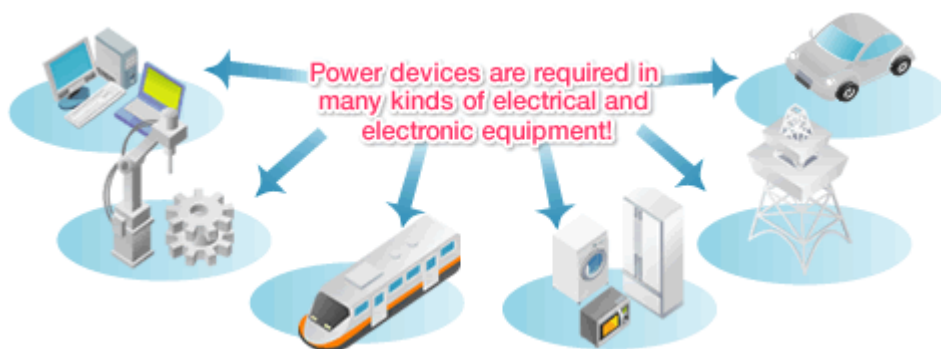

Fiscal 2010 Achievements

Focusing on Market Share Overseas and R&D for New Power Devices

In fiscal 2010, Mitsubishi Electric implemented measures to expand market share in the current mainstream IGBT¹ and IPM² segments. We also developed new products, such as the IGBT NX Series for industrial machinery and the HVIPM³ "R Series" for railway applications, both of which improve on earlier products' ease of use, performance stability, and energy efficiency. In sales, we are developing markets and expanding sales in Europe and China through the local dispatch of engineers to provide applied technology support and systems solutions. In manufacturing, we have set up a production infrastructure tailored to the creation of new products, while increasing production capacity to meet growth in demand.

Toward Full SiC Inverter Commercialization

Mitsubishi Electric is also focusing on the development of next-generation power devices. In particular, we are accelerating the development of silicon carbide (SiC) power modules that are expected to greatly reduce power loss, with the aim of commercializing the technology as soon as feasible.

In fiscal 2010, using a prototype 20kW full SiC inverter (see figure below), we have achieved a 90% reduction⁴ in power loss compared to conventional silicon (Si) inverters. In addition, we developed a hybrid power module consisting of SiC-SBD and Si-IGBT, and succeeded in driving a 300kW passenger railcar drive motor for the first time.

Looking ahead, we will continue to advance device performance and efficiency in the pursuit of the commercialization of products that use SiC.

- 1 Insulated Gate Bipolar Transistor. A power device widely used in control circuits, mainly in industrial inverters and control circuit for motors.
- 2 IPM: Intelligent Power Module. A type of module that incorporates a power device.
- 3 HVIPM: High Voltage Intelligent Power Module.
- 4 90% power loss reduction: At 20 kW output and 20 kHz drive frequency.

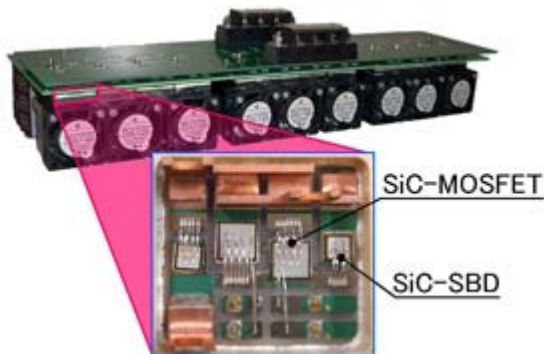

Full SiC Inverter

Inverter that is composed of SiC-MOSFET (Metal Oxide Semiconductor Field Effect Transistors and SiC-SBD (Schottky barrier diodes).

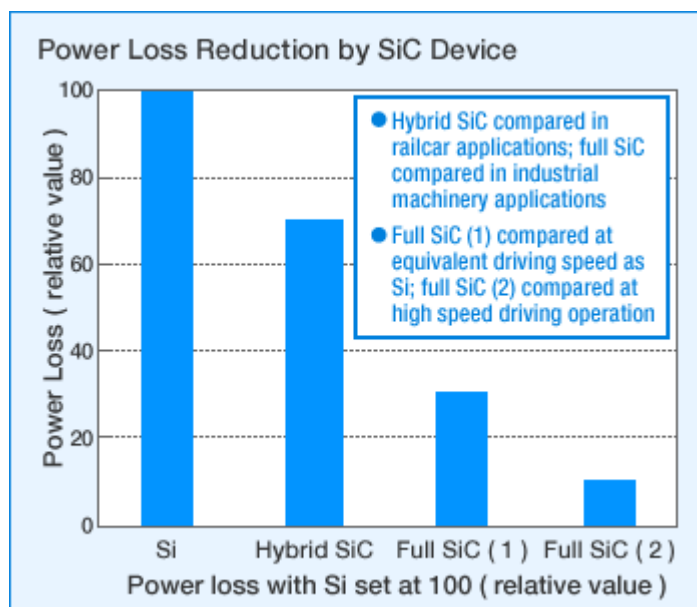
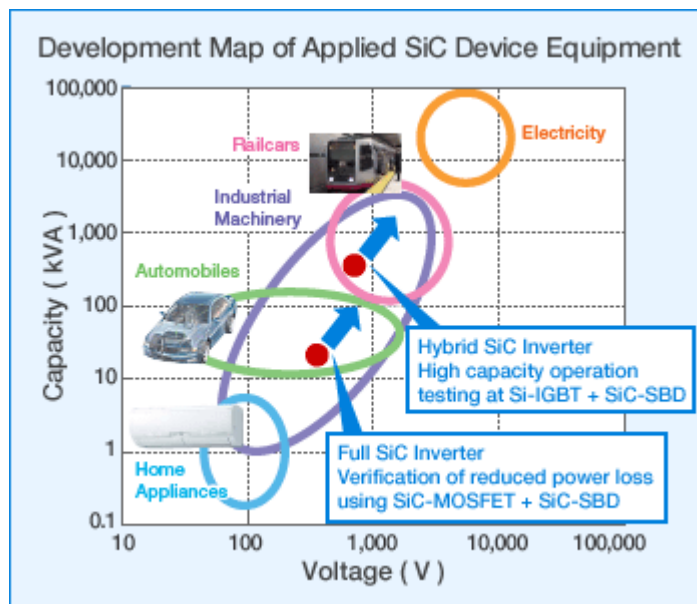

Reducing CO2 from Power Generation

Mitsubishi Electric Group Action Plan

For its power generation business, Mitsubishi Electric has established the target of reducing projected CO2 emissions from facilities and equipment it has delivered or will deliver between FY 2001 and FY 2021 to 90 million tons, through expanding high efficiency and clean power generation equipment. In aiming to achieve this target, Mitsubishi Electric provides solutions from the following viewpoints as it strives to reduce the environmental impact of its facilities and equipment used in the electric power infrastructure.

- Reduce CO2 emissions from existing power generation facilities
- Resolve issues associated with diversification of power supply
- Promote the use of clean energy
- Reduce greenhouse gas emissions from transmission and distribution facilities

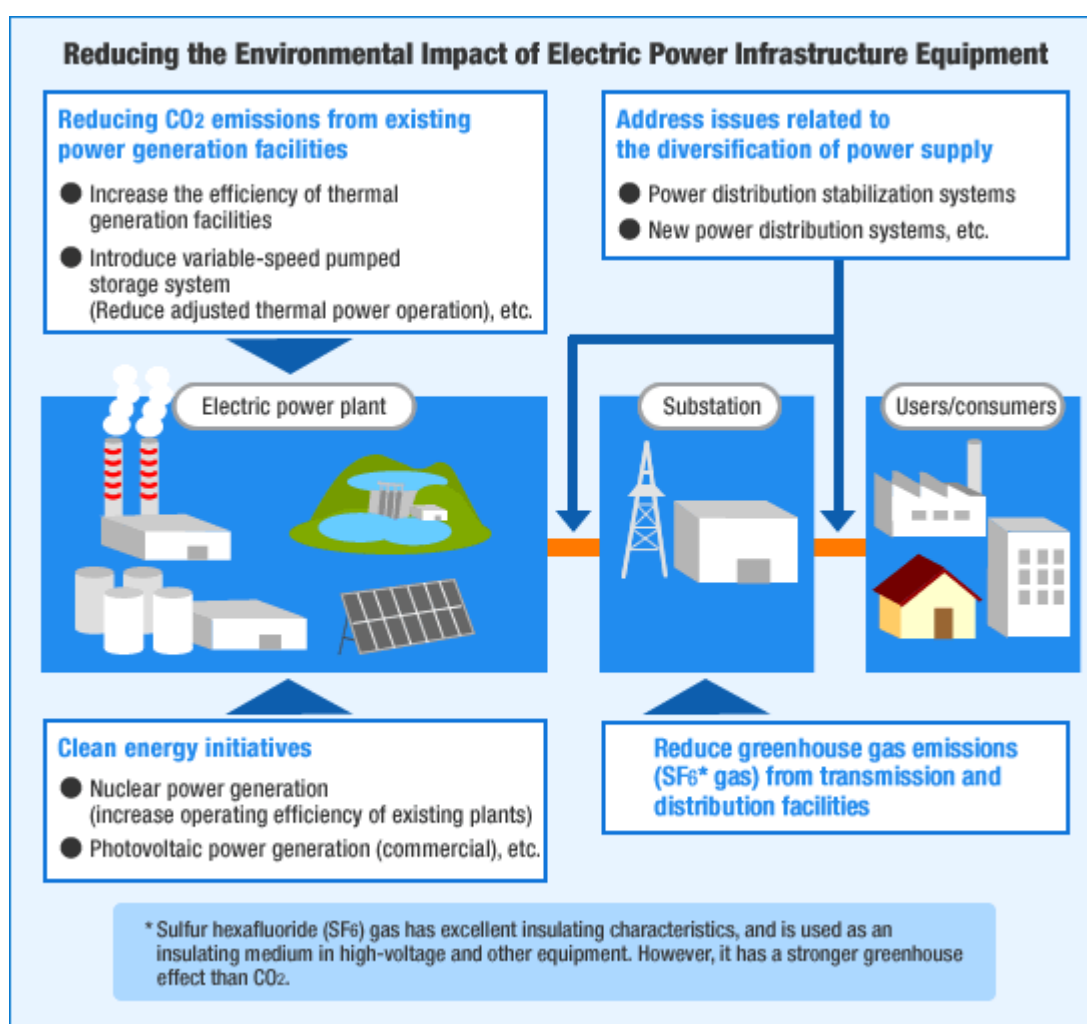

Reduced CO₂ emissions by some 6 million tons, exceeding the annual average reduction required

In fiscal 2010, Mitsubishi Electric moved forward with activities focused on the expansion of clean power generation facilities. In particular, in China, which is planning to increase total nuclear power output to 160 thousand megawatts by 2030, we actively promoted the sales of our digital instrumentation and control system. As a result, Mitsubishi Electric won contracts for two nuclear plants under construction with total output of 1,000 megawatts each. Our instrumentation and control system greatly contributes to the safe operation of nuclear power facilities and has accumulated a strong track record of success in Japan.

In Japan and overseas, we introduced our digital instrumentation and control system to nuclear power plants and high efficiency thermoelectric generation plants, contributing to a 6 million ton reduction in projected CO₂ emissions from power generation. This amount exceeds the average annual reduction required to achieve the target set for the period between fiscal 2001 and 2021.

TOPICS

Launch of Trial Experiments aimed at the Commercialization of Smart Grids

Mitsubishi Electric will begin test trials of smart grid technologies starting in fiscal 2011.

While critical to the creation of a low-carbon society, renewable energies such as photovoltaics remain unstable power sources, the output of which varies depending on weather and other conditions. The smart grid has been the key technology in the spotlight in recent years for its promise to achieve stable power supplies while also incorporating renewable energy. In order to commercialize a viable smart grid solution however, system operations and management must be conducted in the field and data collected and analyzed over a long period of time.

Mitsubishi Electric has constructed three trial experiment facilities located in Amagasaki, Ofuna and Wakayama, Japan to conduct testing that simulates future electricity transmission and distribution grids. Leveraging our strengths and sophisticated proprietary technologies in various smart grid related fields, Mitsubishi Electric is working hard to commercialize smart grid solutions as soon as feasible.

Click here for more details on our smart grid trial experiments 

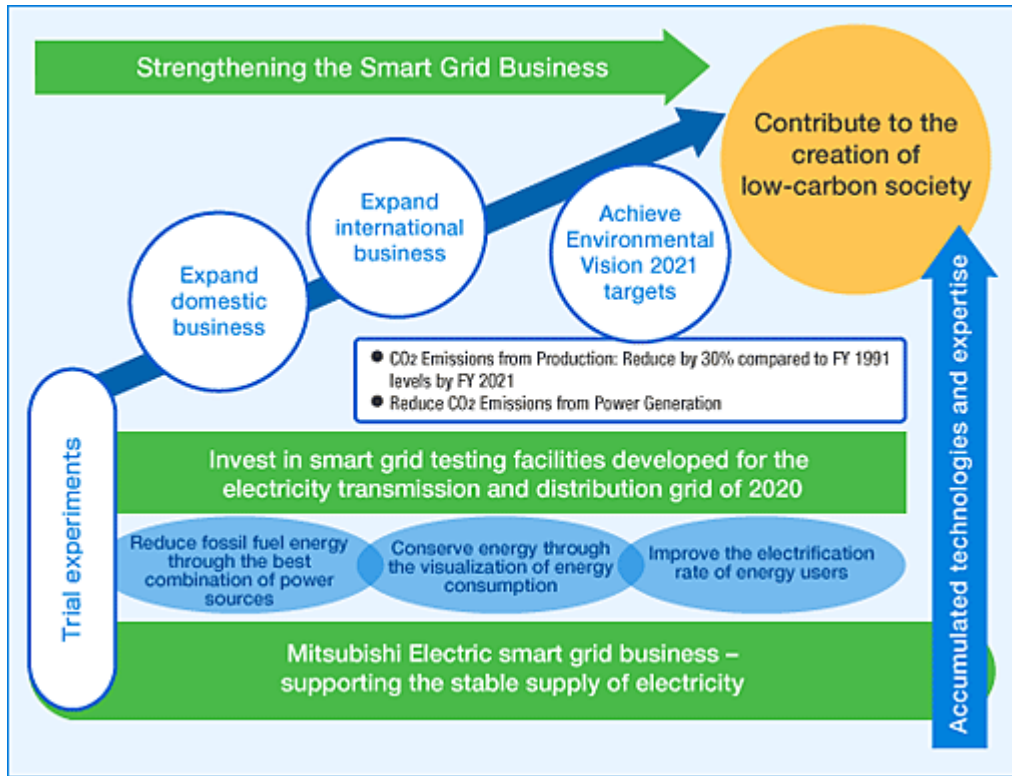

Production & Logistics-Related Initiatives



▶ Reducing CO₂ from Production

Overview of measures to reduce CO₂ emissions, targets for Mitsubishi Electric, our affiliates in Japan and overseas affiliates, fiscal 2010 initiatives and achievements, and plans for the future.

▶ Reducing Emissions of Non-CO₂ Greenhouse Gases

Report on our use of three greenhouse gases and usage reduction measures.

▶ Zero Emissions

Overview of the final waste disposal targets set for Mitsubishi Electric, our affiliates in Japan and overseas affiliates, and fiscal 2010 initiatives and achievements.

▶ Using Water Effectively

Our views on the effective use of water, and the Mitsubishi Electric Group's achievements in fiscal 2010.

▶ Managing Chemical Substances

Managing Chemical Substances in Production
Reducing VOC Emissions

▶ Reducing CO₂ from Logistics

Overview of the Mitsubishi Electric Group's fiscal 2010 achievements in reducing CO₂ emissions through just-in-time improvements to boost logistics efficiency.









▶ Reducing the Use of Disposable Packaging Materials

Overview of the Mitsubishi Electric Group's goals to reduce resource inputs through the 3R's applied to packaging materials, and our fiscal 2010 initiatives and achievements.

Reducing CO₂ from Production

Progress in Fiscal 2010

Creating a Low-Carbon Society

Reducing CO ₂ from Production						
6th Environmental Plan (Fiscal 2010–2012)			Fiscal 2010			Fiscal 2011
		Target	Target	Results	Degree of achievement Self-evaluation	Target
CO ₂ emissions	Mitsubishi Electric	510,000 tons	500,000 tons	472,000 tons		493,000 tons
	Affiliates in Japan	190,000 tons	171,000 tons	166,000 tons		165,000 tons
	Overseas affiliates	230,000 tons	238,000 tons	217,000 tons		215,000 tons
	Total	930,000 tons	909,000 tons	855,000 tons		873,000 tons
Required reduction amount (three years)	Mitsubishi Electric	48,000 tons	16,000 tons	19,000 tons		16,000 tons
	Affiliates in Japan	21,000 tons	7,000 tons	7,000 tons		7,000 tons
	Overseas affiliates	26,000 tons	9,000 tons	8,000 tons		10,000 tons
	Total	95,000 tons	32,000 tons	34,000 tons		33,000 tons

Under Environmental Vision 2021, we have set the goal of a 30% reduction in total CO₂ emissions from production. Toward that end, our 6th Environmental Plan (fiscal 2010–2012) promotes two measures: revealing hidden energy wastage in the production process and addressing those areas through production line improvements; and by raising the efficiency and performance of air conditioning, lighting and other utility equipment.

Groupwide Plan to Reduce CO2 from Production

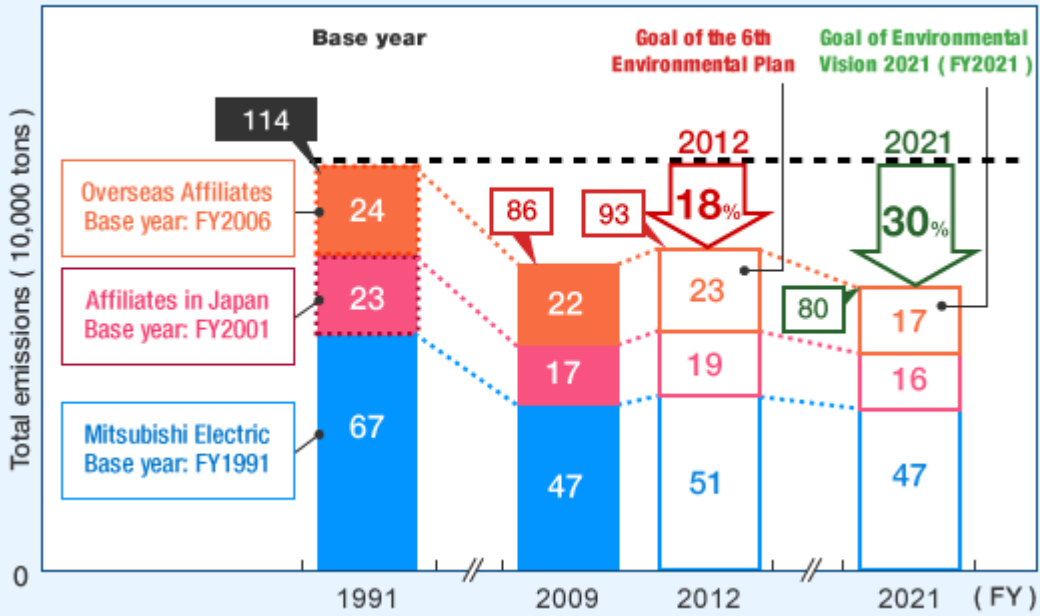

Breakdown of CO2 reduction plan through expansion of production line improvement measures (data for Mitsubishi Electric)

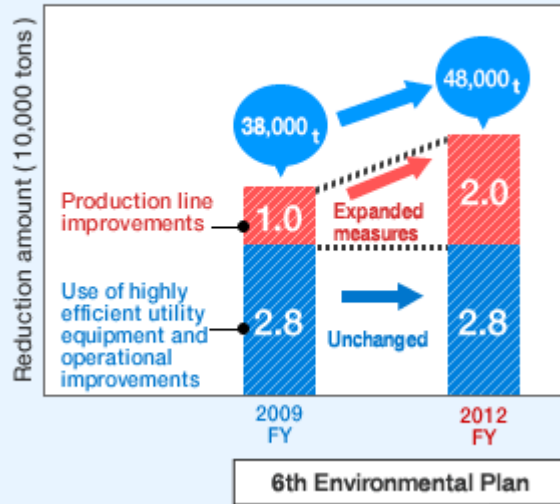

Mitsubishi Electric's Targets and Fiscal 2010 Achievements

Total CO₂ emissions 472,000 tons (4.2-ton reduction from previous fiscal year)
Reduction in CO₂ emissions 19,000 tons (5,000-ton increase from previous year)

Our 6th Environmental Plan sets an objective of 510,000 tons in its final year of fiscal 2012. We have targeted a net 48,000-ton reduction in CO₂ over the three fiscal years of 2010–2012 through two means—production line improvements and increases in utility equipment efficiency.

The 472,000 tons of CO₂ emissions in fiscal 2010 was better than our target of 500,000 tons. These lower emissions stemmed from reduced production during the economic slowdown and also our successful efforts to cut emissions. Looking at production line improvements, we more than doubled our fiscal 2009 target of a 3,000-ton reduction to an actual 7,000 tons, and as a result of activities to address on-site air leaks measures, revise equipment start-up and shut-down times, and improve production yields, we achieved a 9,000-ton reduction. Adding in a 10,000-ton reduction achieved through more efficient use of utility equipment, our total 19,000-ton reduction beat the combined target of a 16,000-ton reduction.

We are taking further steps to separate the emissions volume affected by external factors from the volume we need to address through our actions, so as to better assess effects and achievements in our energy-saving measures.

In fiscal 2010, we established a model area in our head office to study energy-saving measures in our office divisions. By visualizing energy use in the model area, we found we could use less energy for our lighting and equipment such as computers and photocopiers. In fiscal 2011, we plan to report the best examples of energy reduction throughout the head office and branches to increase awareness of ways to save energy and reduce CO₂ emissions.

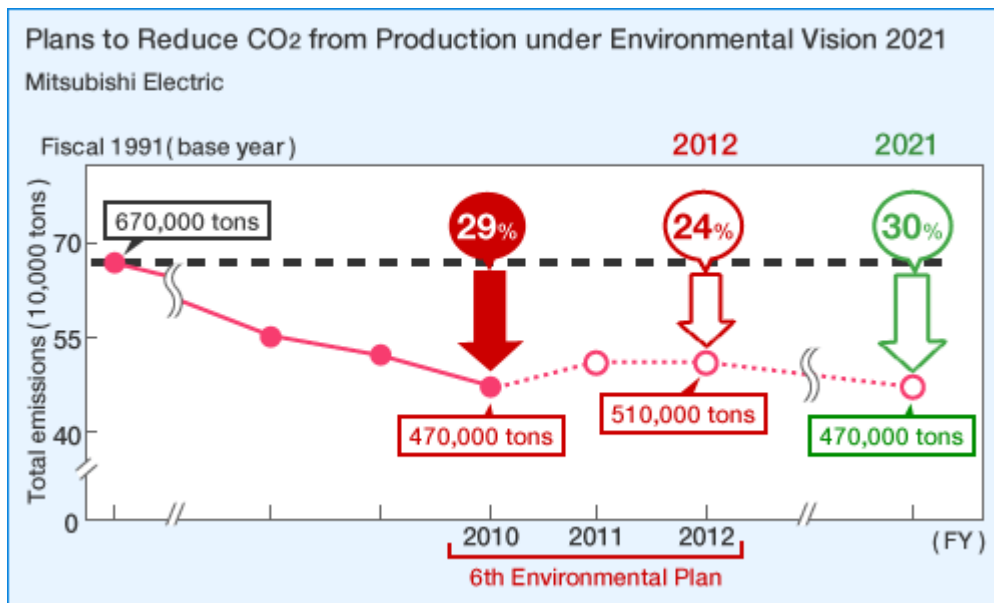

Total CO₂ Emissions

Mitsubishi Electric

(10,000 tons-CO₂)

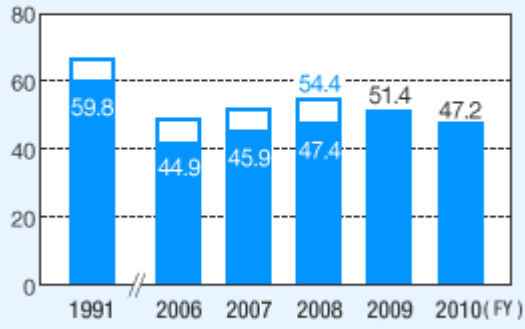

Added 70,000 tons due to acquisition of semiconductor factory in fiscal 2009.

Breakdown of Energy Usage (CO₂ Conversion)

Mitsubishi Electric

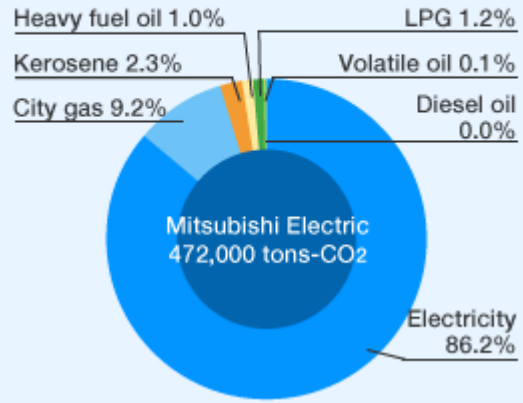

Total CO2 emissions 166,000 tons (23,000-ton reduction from previous fiscal year)
Reduction in CO2 emissions 7,000 tons

We have set a fiscal 2012 CO2 emissions target of 190,000 tons for affiliates in Japan, with a target to reduce emissions by 21,000 tons over the three years of fiscal 2010–2012. We plan to achieve this through production line improvements and increases in utility equipment efficiency.

In fiscal 2010, we carefully measured emissions in each sector and building to help us visualize CO2 emissions at production sites. We also invested in new and upgraded utility equipment. Throughout our activities we made a strict division between impacts on CO2 emissions due to external factors (such as production changes in the slower economy) versus those impacts stemming from our own actions, and as a result produced 166,000 tons of CO2 emissions, beating our target of 171,000 tons.

From our two key initiatives we targeted a total reduction of 6,500 tons: 3,800 tons from production line improvements and 2,700 tons from increases in utility equipment efficiency. We exceeded these targets by cutting a total of 7,000 tons—4,000 tons and 3,000 tons, respectively.

It is difficult to cut CO2 emissions in the factories of our affiliates in Japan because equipment is often dozens of years old. We believe we can effectively and immediately address this by updating utility equipment. While the economic slowdown makes it a challenge to greatly increase investment, we plan to look at priority areas and update equipment based on our mid- and long-term plans.

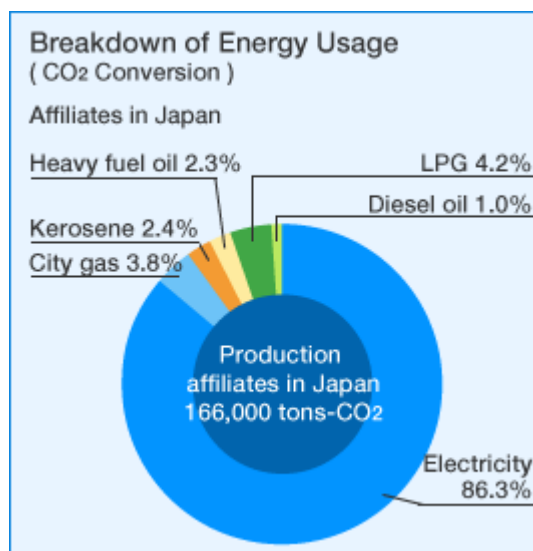
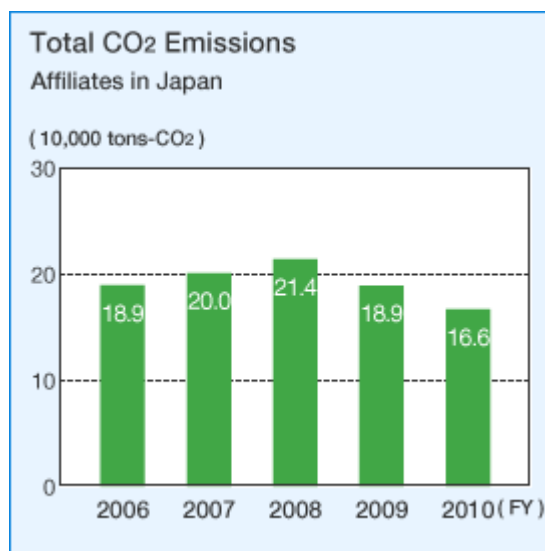
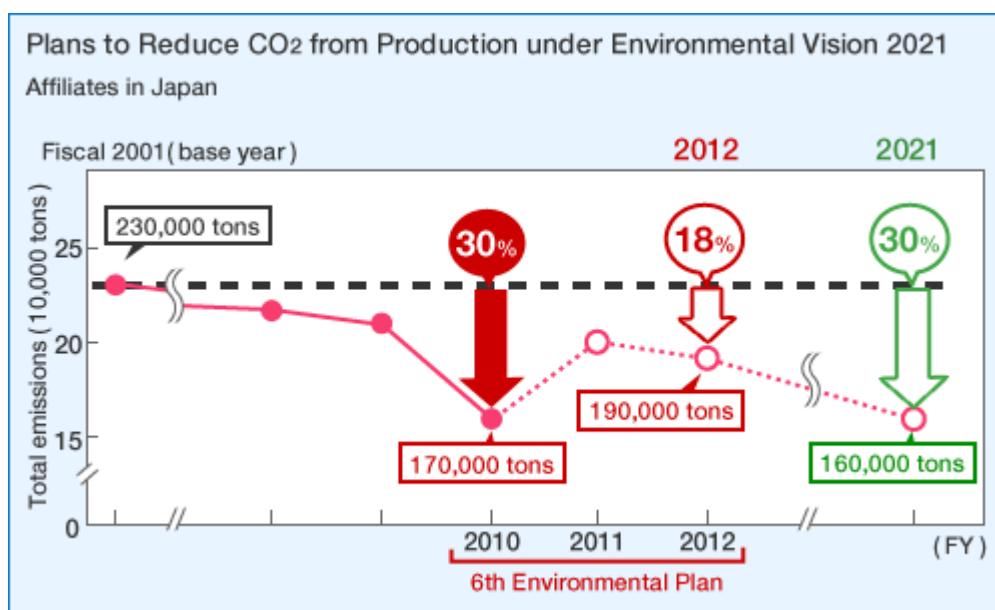

Overseas Affiliates' Fiscal 2010 Targets and Achievements

**Total CO₂ emissions 217,000 tons (28,000-ton reduction from previous fiscal year)
Reduction in CO₂ emissions 8,000 tons**

We have set a fiscal 2012 CO₂ emissions target of 230,000 tons for our overseas affiliates—with a total 26,000 tons of reduction to be achieved over the three years of fiscal 2010–2012 through production line and utility equipment efficiency improvements.

In fiscal 2010, while setting concrete reduction goals and undertaking improvements at our overseas affiliates, we gathered examples of best practices in CO₂ reduction at production sites and shared these among all companies. We dispatched energy-saving patrols to sites with particularly high emissions and proposed improvement measures. As overseas affiliates are primarily engaged in manufacturing, decreases in production affected their CO₂ emissions, which fell below the target of 238,000 tons to 217,000 tons. The level of CO₂ reduction attributable to our actions was 8,000 tons, compared to a goal of 9,000 tons. In fiscal 2011 we intend to strengthen and expand our improvements to accelerate CO₂ reduction.

At our overseas affiliates we will promote CO₂ reduction through production line improvements and through improved efficiency and operation of utility equipment, as we seek out and eliminate waste and strengthen our improvement activities.

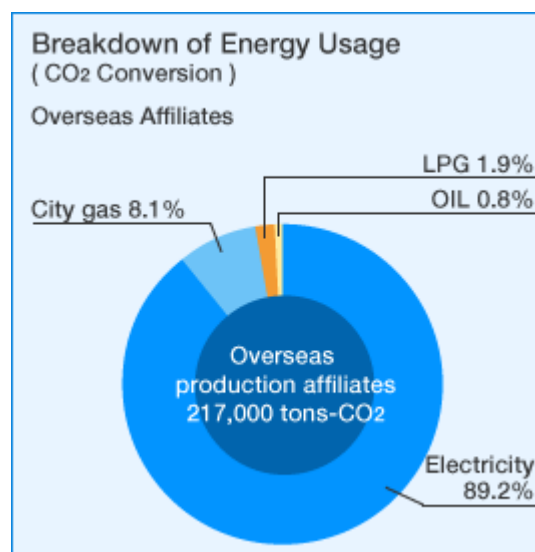
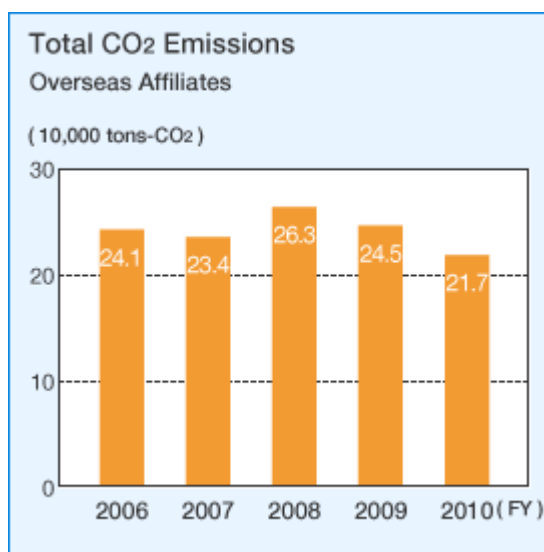
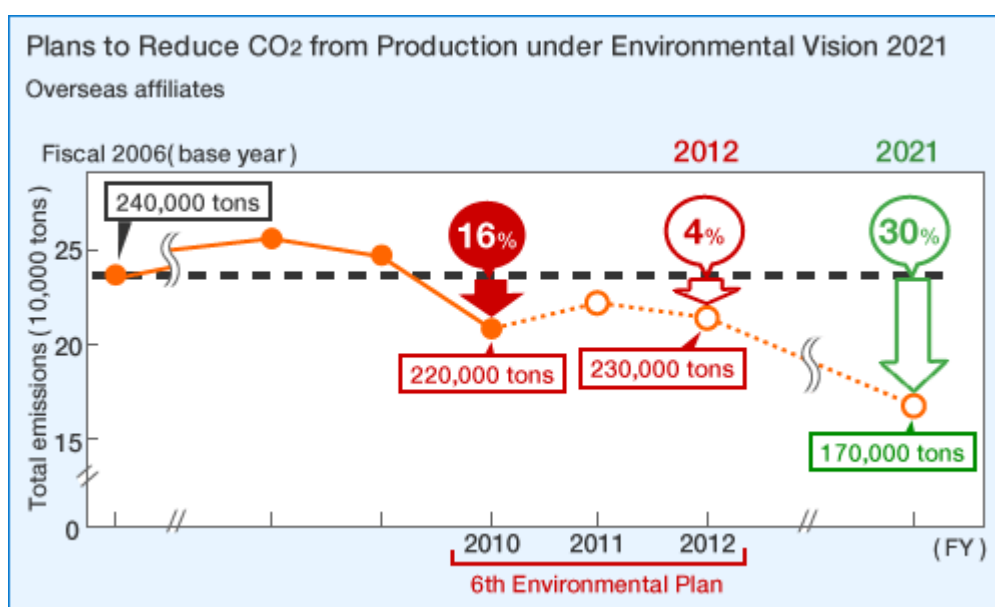

Major CO₂ Reduction Activities

From fiscal 2010 the Mitsubishi Electric Group has embarked upon a new phase in its initiatives to reduce CO₂ from production. We have begun creation of a system in which all factories draw up detailed implementation plans, make all-out efforts to reduce CO₂ emissions, and upon seeing positive results, individually use the PDCA cycle.

To enable this scheme we have initiated two activities: coordination with just-in-time activities; and communication of best practices (and creation and use of tools). Of note is the emphasis on energy conservation within just-in-time activities, which are themselves a productivity improvement initiative integral to our factories. The idea is to promote sustainable energy conservation through the cycle of discovering problems and issues, drafting and executing improvement measures, and verifying effects. To enable factories to more easily assess results, we decided upon an index in fiscal 2010 to convert results into the equivalent CO₂ reduction. Moreover, we implemented patrol activities targeting reduction of CO₂ from production as part of our production line energy conservation improvements and we also developed improvement proposals geared to production site conditions while communicating examples of best practices across the Group.

Beginning inspections by energy conservation experts

Furthermore, to meet the enthusiasm in our factories for finding more areas of improvement, and to strengthen our CO₂ reduction initiatives, we began carrying out inspections by energy conservation experts. We first appointed employees with both a deep knowledge of energy management and strong management experience in general as "energy conservation experts". These experts work across company divisions to check on energy conservation activities, and to support the identification of problems and formulation of improvement measures.

We are putting even more effort into human resource development, including the placement of "energy conservation leaders" to promote improvements from an energy conservation standpoint within production sites. The program selects employees from each site who meet requirements including exceptional knowledge and skill in energy management. These persons then receive training from the Corporate Environmental Sustainability Group as leadership cadets. The cadets learn through participation in activities such as the energy conservation inspections, with the eventual goal of acting as energy conservation experts. The Mitsubishi Electric Group plans to strengthen its energy conservation promotion through fostering such human resources.

Activities in Fiscal 2010

Coordination with just-in-time activities	<ul style="list-style-type: none"> • Check status of a factory's just-in-time activity progress from an energy conservation standpoint • Set an index for converting improvements through just-in-time activities into a CO2 reduction equivalent
Communication of best practices / creation and use of tools	Sharing and dissemination of examples of best-practices for CO2 reduction, making visible the usage conditions and improvements for heat and air which form a major portion of our total energy use
Communication of best practices	<ul style="list-style-type: none"> • Released 117 examples of CO2 reduction best practices on intranet • Worked toward improvements in injection molding machines (heat-related equipment) • Invited energy conservation inspection experts from outside the company and held classes on energy conservation measures for energy-intensive heat-related equipment • Undertook steps to stop air leaks
Creation and use of tools	<ul style="list-style-type: none"> • Deployed thermal viewers (to measure distribution of radiant heat), air leak detectors, and illuminometers • Increased number of Eco-monitor electric power measurement systems
Patrols for reducing CO2 from production	<p>Explaining ideas on production line energy conservation improvements to production-related divisions; implementing on-site patrols to propose improvements</p> <p>Mitsubishi Electric</p> <ul style="list-style-type: none"> • Patrolled all 26 of our production sites, making 134 improvement proposals <p>Affiliated companies</p> <ul style="list-style-type: none"> • Patrolled 7 affiliates in Japan, making 82 improvement proposals • Patrolled 8 overseas affiliates (7 in Asia, 1 in the U.S.), making 77 improvement proposals
Site inspections by energy conservation experts	<p>Appointed personnel with extensive energy conservation knowledge and improvement experience as energy conservation experts; implemented "energy conservation expert inspections " to diagnose energy waste at production sites and propose improvements</p> <p>Mitsubishi Electric</p> <ul style="list-style-type: none"> • Conducted checks at 3 of our production sites, making 382 improvement proposals <p>Affiliated companies</p> <ul style="list-style-type: none"> • Conducted checks at 1 affiliate in China, making 59 improvement proposals

Action Targets for Fiscal 2011

Coordination with just-in-time activities	<ul style="list-style-type: none"> Assessment of the effects of just-in-time activities on CO₂ reduction at all sites and affiliated companies
Communication of best practices / Creation and use of tools	Ongoing sharing and dissemination of best-practice examples of CO ₂ reduction, and making heat and air usage conditions and improvements visible
Communication of best practices	<ul style="list-style-type: none"> Continue the fiscal 2010 task of releasing examples of CO₂ reduction best practices on the intranet, focusing on examples of improvements in production equipment Hold conferences to share examples of CO₂ reduction best practices within the Group Document and disseminate basic concepts behind improving the energy efficiency of heat and air, and clean rooms' energy usage
Preparation and use of tools	<ul style="list-style-type: none"> Use thermal viewers and air leak detectors to make heat and air usage conditions and the impact of improvements more visible Use eco-monitor electric power measurement systems to make power usage conditions and the impact of improvements visible, focusing on affiliated companies
Patrols for reducing CO ₂ from production	<p>Ongoing inspections of manufacturing sites and proposal of improvements, along with dissemination of ideas on production-line energy conservation improvements aimed at production-related divisions.</p> <p>Mitsubishi Electric</p> <ul style="list-style-type: none"> Focus inspections on sites facing greater difficulties with regard to issues such as investment costs or implementing policies, to make improvement proposals and to highlight issues. Undertake improvements to address the technological or policy issues identified <p>Affiliated companies</p> <ul style="list-style-type: none"> Focus inspections on affiliates in Japan with higher CO₂ emissions, and propose improvements Focus inspections on seven overseas manufacturing-related affiliates (four in Asia, three in China), and propose improvements
Site inspections by energy conservation experts	<p>Continue production site checks and improvement proposals by energy conservation experts</p> <p>Mitsubishi Electric</p> <ul style="list-style-type: none"> Focus checks on six domestic factories with higher CO₂ emissions, and propose improvements <p>Affiliated companies</p> <ul style="list-style-type: none"> Undertake new checks at affiliates in Japan, employing external experts on heat and air in addition to our energy conservation experts Focus checks on four overseas affiliates with higher CO₂ emissions, and propose improvements while disseminating examples of domestic best practices
Core personnel training	<ul style="list-style-type: none"> Train four new energy conservation experts Train one energy conservation leader at each site

Examples of common measures

Making energy use visible through "eco-monitor" electrical power measurement systems

The basis of reducing CO₂ emissions is to thoroughly eliminate the waste of energy. Toward that end we're setting "eco-monitors" on all production line equipment to make the status of energy use visible. Added professional analysis of the detailed measurements helps pinpoint places for improvement. We use "energy base units" as an index to aid in managing energy consumption per unit of production.



Example of graph displaying base units (daily)

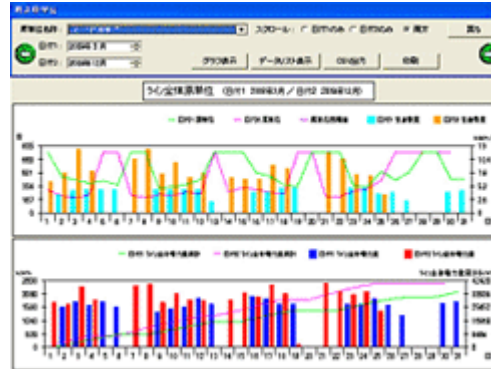

Example of graph displaying base units (monthly)

Measurement data as analyzed by an energy conservation expert



Kazumi Kobayashi
Fukuyama Works

As the daily data shows, base units peak when starting up equipment in the morning and shutting it down at night. That suggests a need to review the time when we turn power on and off.

Monthly data shows a large difference in base units for March (green) and December (red) 2009, highlighting busy times like the end of a fiscal period and not-so-busy times, or seasonal differences in equipment operation. This allows us to conjecture sources of wasted energy.

Reducing Emissions of Non-CO2 Greenhouse Gases

Reducing HFCs, PFCs, and SF6

Reducing emissions through alternative substances and equipment improvements

Non-CO2 greenhouse gases emitted by the Mitsubishi Electric Group during its business activities include SF6 (sulfur hexafluoride, an electrical insulating gas used in gas insulated switchgear), HFCs (hydrofluorocarbons, gases used as refrigerants in air conditioners and refrigerators), and PFCs (perfluorocarbons, used as an etching gas for production of semiconductors and liquid crystals).

As these gases produce greenhouse effects hundreds or even tens of thousands of times greater than that of CO2 (see below), we make special efforts to reduce their use. In particular, we are actively implementing performance enhancements and replacement of aging gas recovery devices to handle SF6, with its very high global warming potential.

In fiscal 2010 we worked to reconfigure equipment for enhanced air-tightness and to improve gas leak detection equipment in pipes. As a result, the Mitsubishi Electric Group's SF6 emissions declined 2.2 tons (20%), from 10.9 tons in fiscal 2009 to 8.7 tons in fiscal 2010.

We have also undertaken improvement of fluorocarbon recovery efficiency with regard to HFCs. Our emissions were 4.6 tons, a 1.0 ton (18%) reduction from 5.6 tons in fiscal 2009.

For the reduction of PFCs, we reduced atmospheric emissions not only by deploying more removal units, but also by reducing our use of PFCs, replacing etching gases with alternatives that have a lower greenhouse gas effect. As a result, our emissions were 10.0 tons, an 11.2 ton (53%) reduction from 21.2 tons in fiscal 2009.

In fiscal 2010, the reporting of greenhouse gases under the Law Concerning the Promotion of the Measures to Cope with Global Warming was revised from a "per workplace" focus to a "per worker" focus. Against this background, we conducted particularly thorough surveys of our emissions. We will implement specific measures to improve workplaces with the greatest emissions.

Comparison of Greenhouse Effects of CO2, HFCs, PFCs, and SF6

Chemical formula	GWP(Global Warming Potential)
CO2	1
SF6	23,900
HFCs	140–11,700
PFCs	6,500–9,200

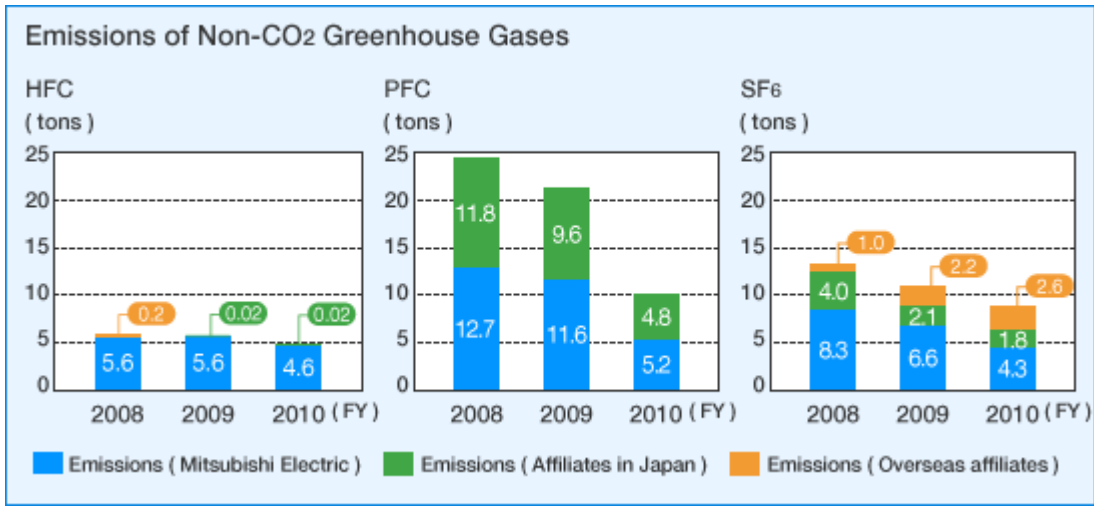

Example of SF6 Reduction Drastically reducing SF6 emissions through "closed cycle" activity

In an effort to reduce the environmental impact of SF6, an industrial gas with a particularly high greenhouse gas effect, we've initiated "closed cycle" activity at a number of production sites in Japan.

"Closed cycle" refers to the prevention of the atmospheric escape of SF6 gas from pipework or equipment—ultimately, our goal is the achievement of "zero gas leaks". We investigate the time and location of SF6 leaks through analysis of data such as pressure changes in recovery tanks, and once the cause is identified take action immediately to cut off the emissions. Through these efforts, we've succeeded in reducing annual emissions by as much as three tons or more.

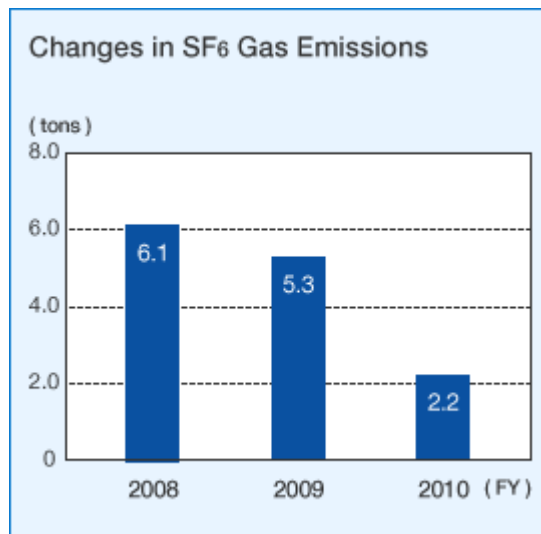

Zero Emissions

Targets of the 6th Environmental Plan (Fiscal 2010–2012) and Fiscal 2010 Progress

Zero Emissions		Fiscal 2010	
6th Environmental Plan (Fiscal 2010–2012) Fiscal 2012 Targets		Results	Degree of achievement Self-assessment
Mitsubishi Electric	Final disposal ratio of less than 0.1%	0.04%	😊
Affiliates in Japan	Final disposal ratio of less than 0.5%	0.2%	😊
Overseas affiliates	Final disposal ratio of less than 3.0%	3.6%	😊

Environmental Vision 2021 includes the goal of reducing the final disposal ratio of waste to less than 0.1% at all Group sites. As initial steps toward to achieving that goal, the 6th Environmental Plan (fiscal 2010–2012) includes targets of less than 0.1% for Mitsubishi Electric, less than 0.5% for affiliates in Japan, and less than 3.0% for overseas affiliates, with steps taken at every site to address the production and disposal of waste.

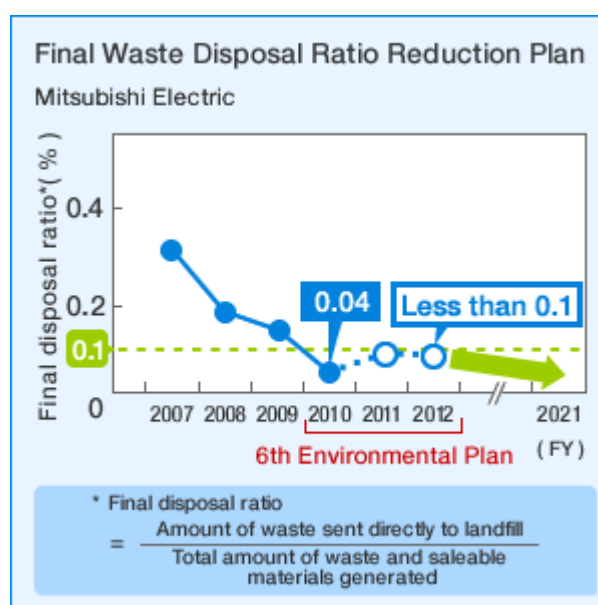

Final Waste Disposal Ratio Reduction Plan

Affiliates in Japan

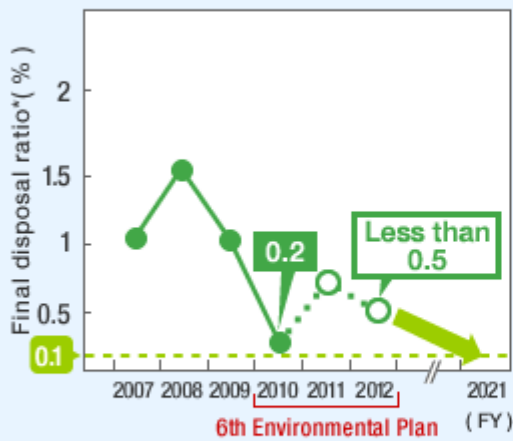

Overseas affiliates

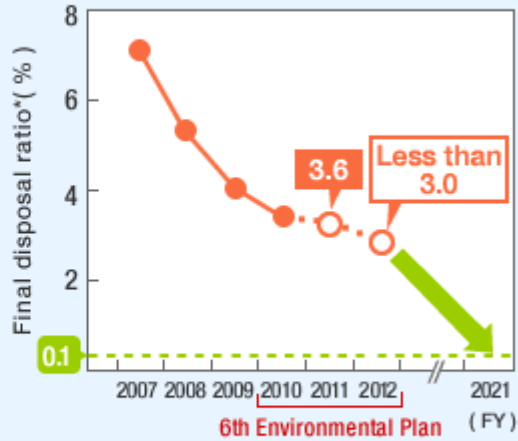

* Final disposal ratio

$$= \frac{\text{Amount of waste sent directly to landfill}}{\text{Total amount of waste and saleable materials generated}}$$

Total Waste Output and Final Disposal Ratio

Mitsubishi Electric Group

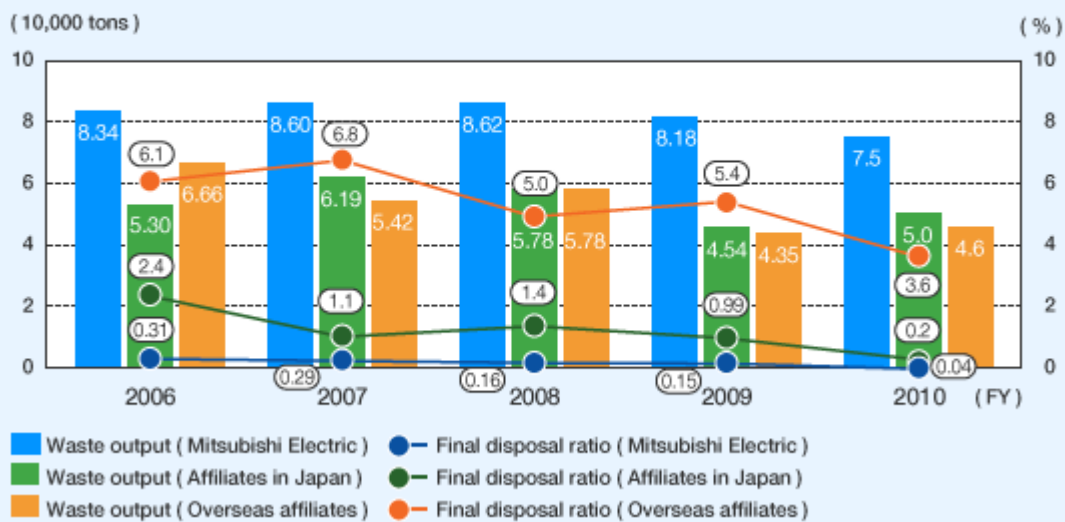

Final waste disposal ratio target: Less than 0.1%

→ **Achievement in fiscal 2010: Less than 0.1%**

Thorough waste separation and conversion to saleable materials, communication of best practices, and cooperation among factories lead to solid progress!

Total waste emission in fiscal 2010 was 75,000 tons, and the final disposal rate was less than 0.1%.

Thorough separation of waste is an effective way to reduce our final disposal ratio. As production sites that manufacture different products also produce different types of waste, we create action plans specific to each site. In fiscal 2010, we thoroughly checked wastes targeted for final disposal at each site, identifying three sites with disposal issues requiring solutions. With improvement measures enacted at those sites, we expect all sites to achieve their targets in fiscal 2012.

One noteworthy initiative is our coordinated regional waste disposal. We have carried out coordinated regional waste disposal to increase the effective use of waste. Following the "recycling logistics" that began at five factories in five Kansai region districts in 2007, we expanded the program to the Kyushu area in fiscal 2010 with four production sites and three affiliated companies participating. All waste disposal managers from the factories visited each factory together to cooperatively share information on waste disposal firms, identify numerous points for improvement, and, as in the Kansai region, successfully achieve ideas aimed at waste logistics. ([Environmental Topics: Coordinated Regional Waste Recycling \[Kyushu Region\]](#))

The above are examples of large-scale coordination, but we're accumulating smaller cooperative successes as well. Through such ongoing activities, we are striving for our "near-zero" goal of less than 0.1%.



Targets for Affiliates in Japan and Fiscal 2010 Achievements

Final waste disposal rate target: Less than 0.5%

→ **Achievement in fiscal 2010: Less than 0.2%**

On-site checks by head office yield results beyond our targets!

Our measures to address final disposal in fiscal 2010 included a paper-based survey of waste disposal at eight companies. In addition, a team that included members of the Corporate Environmental Sustainability Group made a patrol of four companies for on-site checks into the status of waste disposal, identifying problems and brainstorming solutions.

The results of these surveys showed a total of 50,000 tons of waste output in fiscal 2010, yielding a final disposal rate of 0.2% that surpassed our target for affiliates in Japan. In fiscal 2011 we will continue improvement activities incorporating on-site perspectives, and keep up initiatives to enable all sites to meet targets.

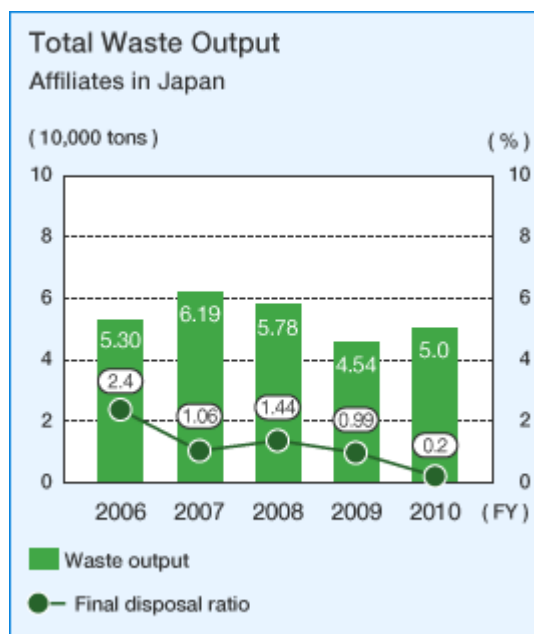

Targets for Overseas Affiliates and Fiscal 2010 Achievements

Final waste disposal ratio target: Less than 3.0%

→ **Achievement in fiscal 2010: Less than 3.6%**

Taking sure steps toward meeting targets

With laws, regulations, and waste treatment conditions differing by country or region, our activity plans for overseas affiliated companies must be tailored to each site's circumstances.

In fiscal 2010 we carried out a detailed survey of waste disposal conditions at eight companies that have a high final disposal ratio. We then proposed solutions and disseminated examples of best practices. As a result we achieved 46,000 tons of total waste output and a final disposal ratio of 3.6% at our overseas sites, a great improvement over fiscal 2009.

In fiscal 2011 we plan to patrol sites not meeting targets to perform on-site checks, as we do with affiliates in Japan, and will then enact effective solutions in line with each country's conditions.

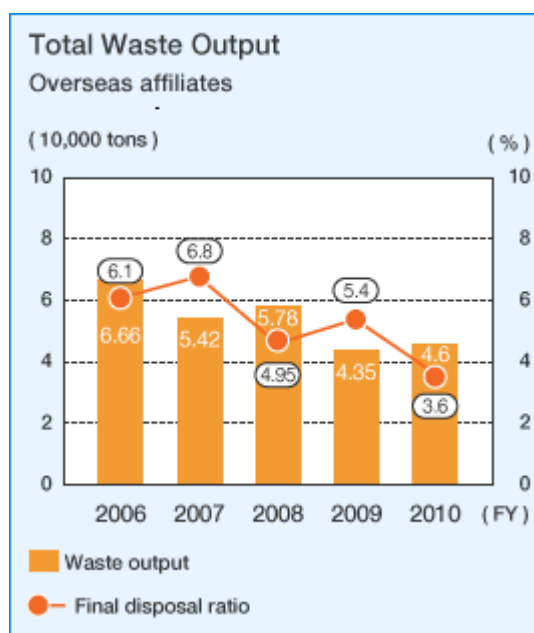

Using Water Effectively

Promoting the Recycling and Reuse of Water at Business Sites

Promoting the "3R's" of water, in Japan and overseas

The Mitsubishi Electric Group works toward the effective use of vital water resources, including tap water, industrial water, and groundwater, from the same "3R's*" perspective we apply to production materials or energy. Our total water consumption in fiscal 2010 was 9.58 million m³, an 11.8% reduction from the previous year's 10.86 million m³. With our use of recycled water affected by the closure of a circuit board factory, the volume of water recycled was 3.05 million m³, for the same 31.8% recycling rate as in the previous year.

Total water consumption by affiliates in Japan was 3.65 million m³, a 16.5% reduction from the previous year's 4.37 million m³. The water recycling rate was 41.9%, a 2.1 percentage point improvement over the previous year's 39.8%.

Total water consumption by overseas affiliates was 1.64 million m³, a 9.4% reduction from the previous year's 1.81 million m³. The water recycling rate was 5.8%, a 1.2 percentage point improvement over the previous year's 4.6%.

In addition to domestic activities to reduce water usage, in fiscal 2010 we undertook noteworthy activities overseas. These included the promotion of rainwater recycling in factories in India and improved utilization of water on production lines in China.

In fiscal 2011 we'll further pursue improvement activities to promote the "Water 3R's". By working toward more effective use of resources we can contribute to the creation of a recycling-based society.

*3R's: Reduce, Reuse, and Recycle.

Breakdown of Water Usage

Mitsubishi Electric

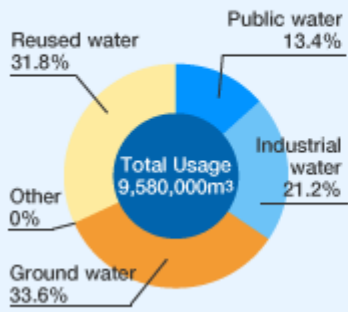

Affiliates in Japan

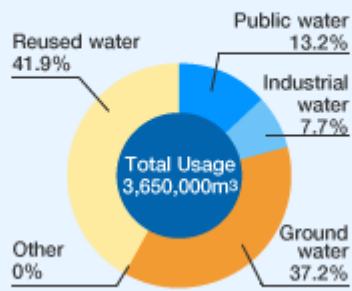

Overseas affiliates

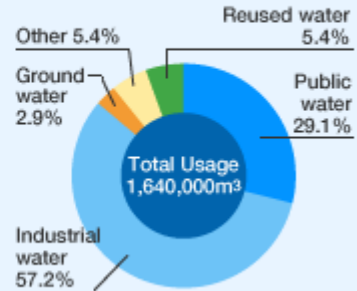

Total Water Usage

Mitsubishi Electric

(10,000m³)

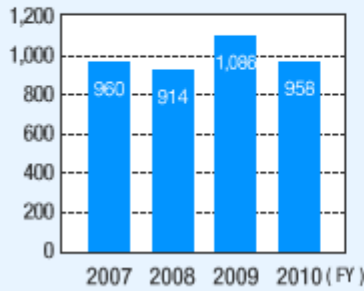

Affiliates in Japan

(10,000m³)

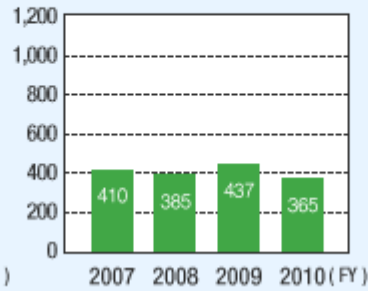

Overseas affiliates

(10,000m³)

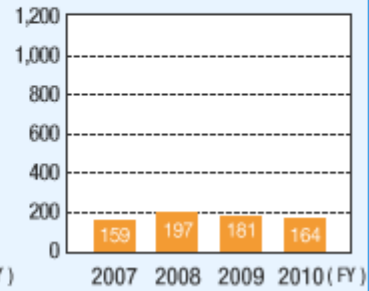

Water Recycling Ratio

Mitsubishi Electric

(%)

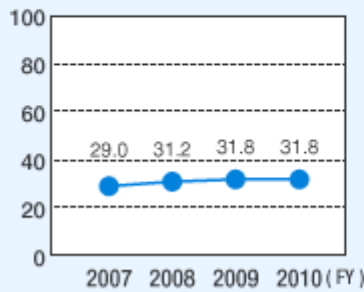

Affiliates in Japan

(%)

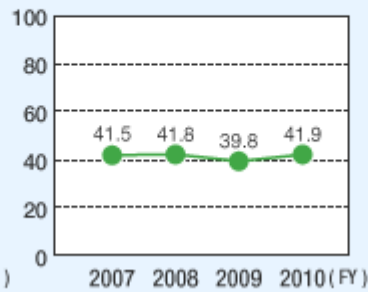

Overseas affiliates

(%)

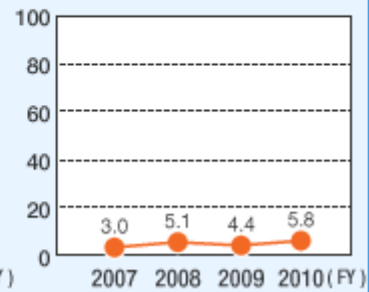

Example of Water 3R's (1)

Groundwater replenishment through rainwater recycling

At our production site in India, where water resources are particularly valued, we've built a system that efficiently pipes collected rainwater to the aquifer*. Giving this small push to a natural system supports the long-term use of groundwater without undue strain.

* Aquifer: A layer of water-permeable rock.

Example of Water 3R's (2)

Improving water usage throughout the production line

By rethinking the entire product painting lines at our production sites in China, we've succeeded in greatly reducing total water usage.

We improved washing equipment that required large quantities of water to cut usage, slashing the waste of water. Further, by reworking the water filtering and recovery system to stop excess sediments from clogging the filters and lowering the recovery rate, we boosted water recovery and reuse.

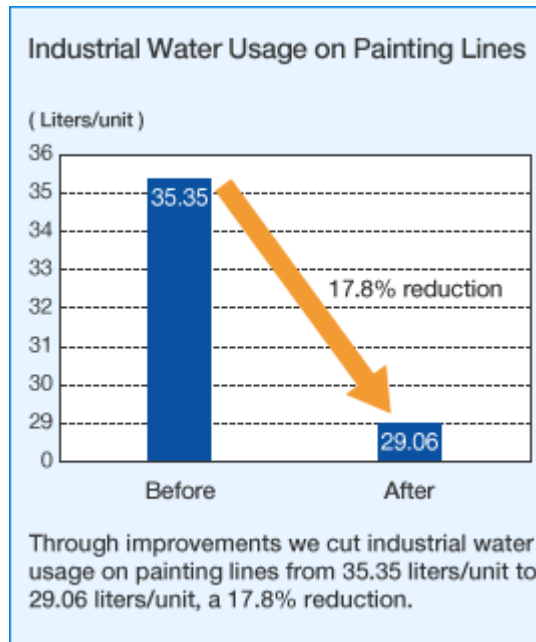

Managing Chemical Substances

Managing Chemical Substances in Production

Report on the status of chemical substance management under our own Chemical Substance Management System.

Reducing VOC Emissions

Initiatives toward controlling atmospheric release of VOCs under the 6th Environmental Plan.

Managing Chemical Substances

Managing Chemical Substances in Production

Managing Controlled Chemical Substances using Our Own Chemical Substance Management System

Revising our list of voluntarily-managed chemical substances to 2,097 items

Mitsubishi Electric and its affiliates in Japan have been managing chemical substances on a voluntary basis since 1997. These include refrigerant fluorocarbons (HFC¹ and HCFC²) used in air conditioners and refrigerators, VOCs (volatile organic compounds), and the six RoHS substances. Combined with the 462 substances designated under the PRTR law³ revised in November 2009 (354 substances before revision), the above comprise a current list of 2,097 substances we voluntarily manage under our comprehensive Chemical Substance Management System that encompasses purchasing information about materials and components.

In fiscal 2010 Mitsubishi Electric used 115 different chemical substances totaling 5,013 tons (fiscal 2009: 111 substances, 5,812 tons), while affiliates in Japan used 50 substances totaling 1,885 tons (fiscal 2009: 58 substances, 2,038 tons). Details of the release and transfer of these substances is shown in the figure below, while the 10 substances with the highest volume of release and transfer by the Mitsubishi Electric Group are outlined in the table below. We'll continue to assess and manage our use of these substances while we make efforts to eliminate any waste.

1 HFC: hydrofluorocarbon

2 HCFC: hydrochlorofluorocarbon

3 PRTR: Pollutant Release and Transfer Register, a system by which businesses assess and report to authorities the volume of potentially harmful chemical substances released into the environment and the volume transferred within waste. Authorities, in turn, compile and release information on total volumes based upon the reports and other statistics.

Material Balance of Chemical Substances Subject to Regulation

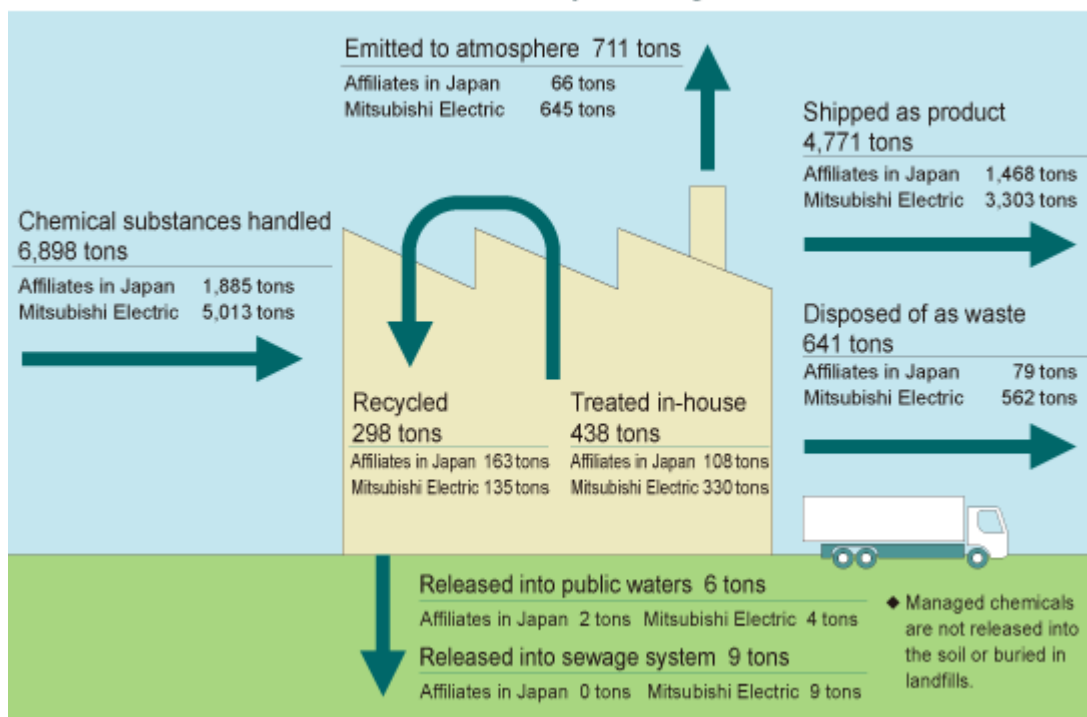

Mitsubishi Electric Group Chemical Release/Transfer Ranking (Fiscal 2010)

Mitsubishi Electric (Unit: tons)

Rank	Substance	Amount handled	Amount released/ transferred	Amount eliminated/ recycled	Amount consumed
1	Pentafluoroethane	1,228	8	6	1,214
2	Difluoromethane	1,218	7	5	1,205
3	Isopropyl alcohol	705	439	233	33
4	Styrene	242	115	0	127
5	Lead and lead compounds	236	15	7	214
6	Polymer of 4,4'-isopropylidenediphenol and 1-chloro-2,3-epoxypropane (liquid)	182	12	8	151
7	Antimony and antimony compounds	165	5	5	155
8	Hydrogen fluoride and other water soluble salts	134	17	117	0
9	Butyl acetate	118	116	2	0
10	Xylene	111	78	8	25

Affiliates in Japan (Unit: tons)

Rank	Substance	Amount handled	Amount released/ transferred	Amount eliminated/ recycled	Amount consumed
1	Styrene	511	21	17	473
2	Polymer of 4,4'-isopropylidenediphenol and 1-chloro-2,3-epoxypropane (liquid)	366	6	0	360
3	2-aminoethanol	176	0	156	20
4	Methanol	103	12	26	65
5	Toluene	87	31	16	40
6	Tetrahydromethylphthalic anhydride	84	1	0	83
7	Methyl ethyl ketone	82	9	21	52
8	Maleic anhydride	74	4	0	70
9	Xylene	71	31	3	37
10	Phenol	56	1	0	55

Managing Chemical Substances

Reducing VOC Emissions

Targets of the 6th Environmental Plan (fiscal 2010–2012) and Fiscal 2010 Progress

Reducing VOC Emissions				
6th Environmental Plan (Fiscal 2010–2012) Fiscal 2012 Targets	Fiscal 2010			Fiscal 2011
	Emissions target	Results	Degree of achievement Self-assessment	Target
40% reduction (base year FY2001) Emissions: 598 tons	Emissions: 535 tons	Emissions: 498 tons	😊	Emissions: 528 tons

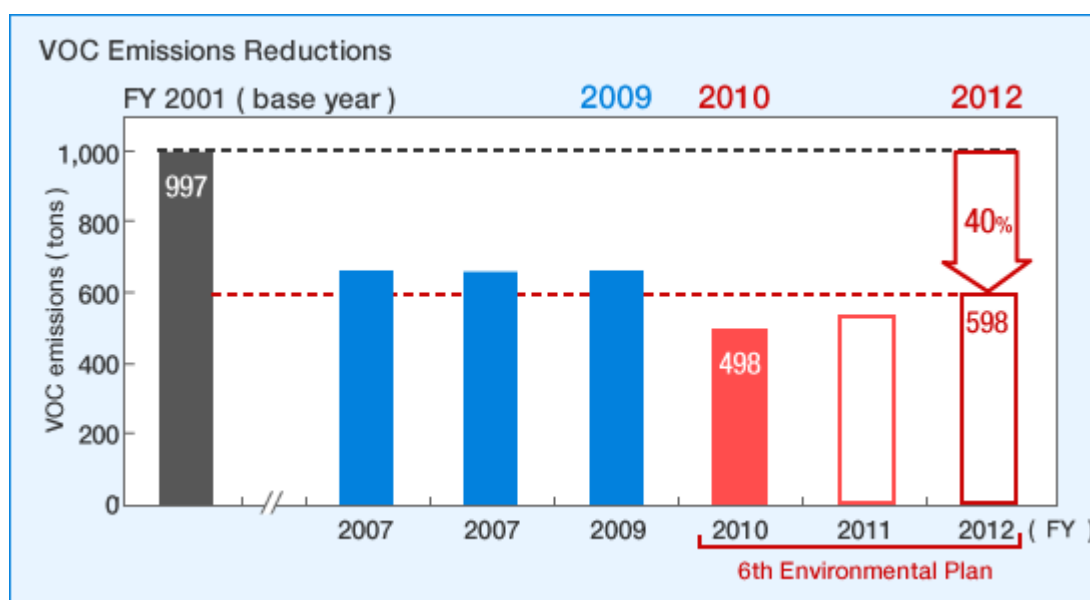

* During formulation of the 6th Environmental Plan, initially factories with high levels of emissions were targeted, but in fiscal 2010 we extended our activities to cover all factories.

Activities to reduce the emissions of volatile organic compounds (VOCs) into the atmosphere are required by the Air Pollution Control Law. In response, the electrical and electronic products industry has adopted a voluntary action plan to cut fiscal 2011 emissions to 30% below fiscal 2001 levels. Mitsubishi Electric has set a voluntary plan with even stricter targets, and under the 6th Environmental Plan is taking action toward that goal, with the additional perspective of reducing resource inputs.

In addition to using alternative materials, the Company is reviewing processes that use VOCs and studying the redesign of these processes where possible. By fiscal 2012, we aim to reduce VOC emissions into the atmosphere by 40%, compared with fiscal 2001 levels.

VOC emissions were 498 tons in fiscal 2010—better than our target

Mitsubishi Electric's greatest issue regarding chemical substances is controlling emissions of VOCs such as styrene and xylene. In fiscal 2010, we installed VOC removal equipment at two production sites (Himeji and Inazawa). We reduced our use of paints/coatings containing VOCs through such steps as boosting the adherence level of the paint or coating through sprayer design improvements, and switching to non-coated products.

Through these steps, we reduced VOC emissions in fiscal 2010 to 498 tons, a great improvement on fiscal 2009's 668 tons. This achievement also marks a 50% reduction from the base level appearing in the 6th Environmental Plan, already surpassing the 40% reduction that the Plan calls for by fiscal 2012.

We also patrolled production sites in fiscal 2010 to survey the emissions from individual manufacturing processes. Based on the findings, in fiscal 2011 we will draft and implement concrete control measures such as process and equipment improvements, focusing on sites with high emissions. In addition we will disseminate examples of best practices and continue our ongoing activities to eliminate waste.

Reducing CO₂ from Logistics

Basic Policies on Logistics

The Mitsubishi Electric Group carries out just-in-time activities to improve logistics. These activities quantify logistics work to make it transparent, opening the door to greater efficiency and economy by eliminating irrational, irregular, and wasted efforts. We're also working to reduce environmental impact via "Eco-Logistics" (Economy & Ecology Logistics).

The Mitsubishi Electric Group's Fiscal 2010 Targets and Achievements

Target:	Cut CO₂ emissions 3% from fiscal 2009 levels in the fiscal years 2010–2012
Result:	Fiscal 2010 CO₂ emissions were 112,000 tons, a 12,000-ton or 9.3% reduction from fiscal 2009

The 6th Environment Plan (fiscal 2010–2012) for Mitsubishi Electric and our affiliates in Japan sets a CO₂ emissions target of 3% below fiscal 2009 levels. We took several steps to achieve this goal, including the following:

- Reducing the number of trucks and frequency of journeys (e.g. having multiple factories coordinate joint delivery of products to multiple destinations in the same area)
- Improving transport efficiency by optimizing operations to handle fluctuations in shipment volume
- A modal shift from truck to rail or marine transportation

CO₂ emissions for Mitsubishi Electric in fiscal 2010 were 92,000 tons (an 8,000-ton or 8% reduction from fiscal 2009). Emissions for affiliates in Japan were 20,000 tons (a 4,000-ton or 15% reduction from fiscal 2009). The total 12,000-ton reduction in emissions can be attributed to two factors: Reduced production due to the economic slowdown and the use of smaller and lighter products causing a drop in product shipment volume to 15 million tons (down from 17 million tons in fiscal 2009); and the proactive implementation of measures to reduce emissions. We will keep working toward realizing our Eco Logistics vision by continuing to strive to reduce emissions.

Our overseas affiliates are making efforts to ascertain detailed information on CO₂ emissions and expanding reduction measures through the tailoring of transport methods to local conditions. In fiscal 2010 we collected data from 20 companies (compared with 19 the previous year).

We calculated our CO₂ emissions to be 177,000 tons, a 2,000-ton reduction from 179,000 tons in fiscal 2009. Our data for overseas companies covers in-country logistics, export logistics, and a portion of procurement logistics.

Total CO2 Emissions
Mitsubishi Electric / Affiliates in Japan

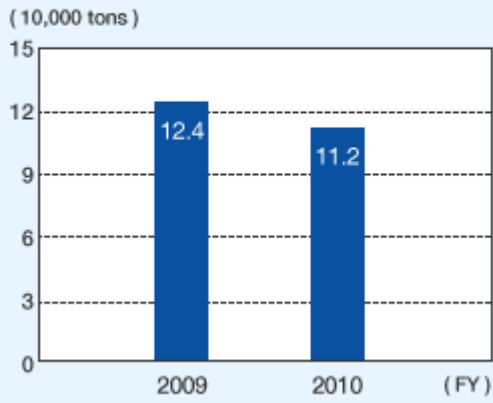

Fiscal 2010 Share of Transport by Mode
Mitsubishi Electric / Affiliates in Japan

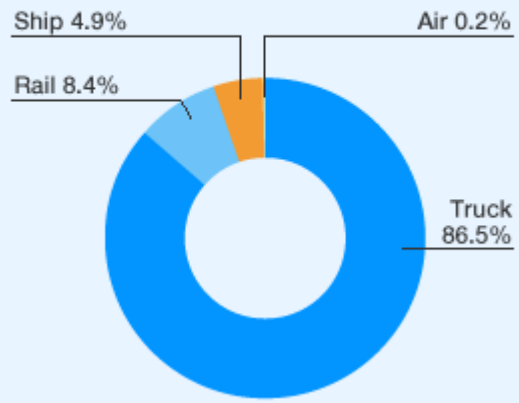

Total CO2 Emissions
Mitsubishi Electric

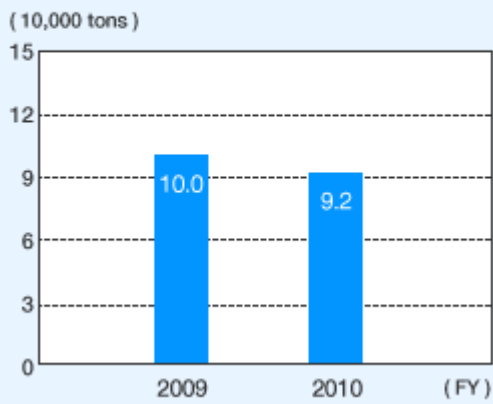

Fiscal 2010 Share of Transport by Mode
Mitsubishi Electric

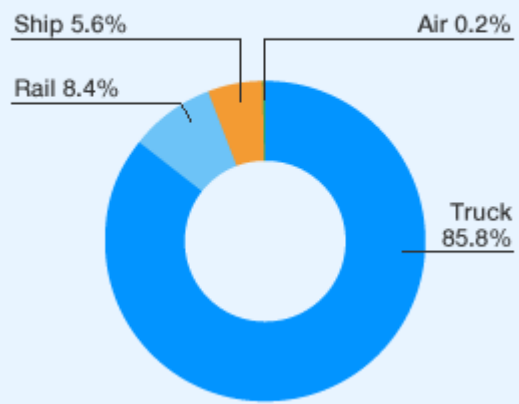

Example of CO2 Reduction Activity in Logistics Promotion of Eco-Logistics Activities

From April 2009 through March 2012, we are rolling out "Eco-Logistics" activities at all production sites in Japan. Eco-Logistics, an abbreviation of "Economy & Ecology Logistics," is an initiative to increase logistics efficiency through better visibility and simplicity, reducing both costs and environmental impact.

Example of Cooperative Shipping through Warehouse Consolidation

In cases of separate shipments from neighboring factories to the same destination, consolidating warehouses and shipping routes allows a reduction of CO2 emissions and costs.

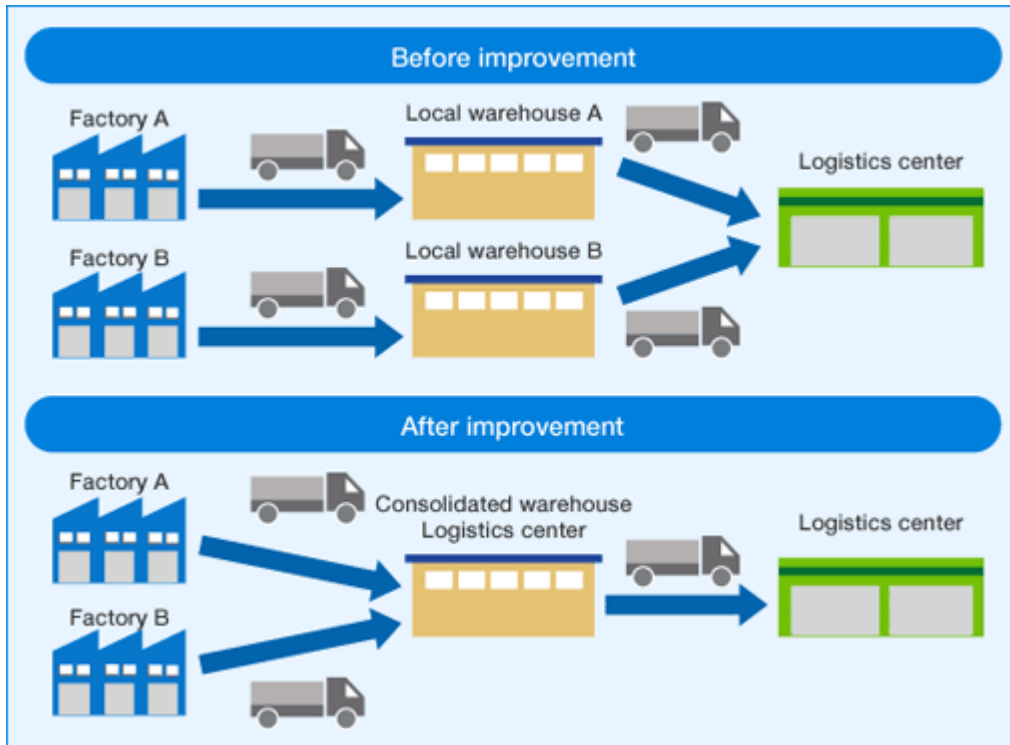

Initiatives to boost logistics efficiency through regional coordination

Example of Modal Shift

Rail transportation of 500 km or more constitutes over 30% of product logistics for our Living Environment & Digital Media Equipment Group*, enabling certification by the Japanese "Eco Rail Mark" system. We are working to make active use of marine transportation as well.



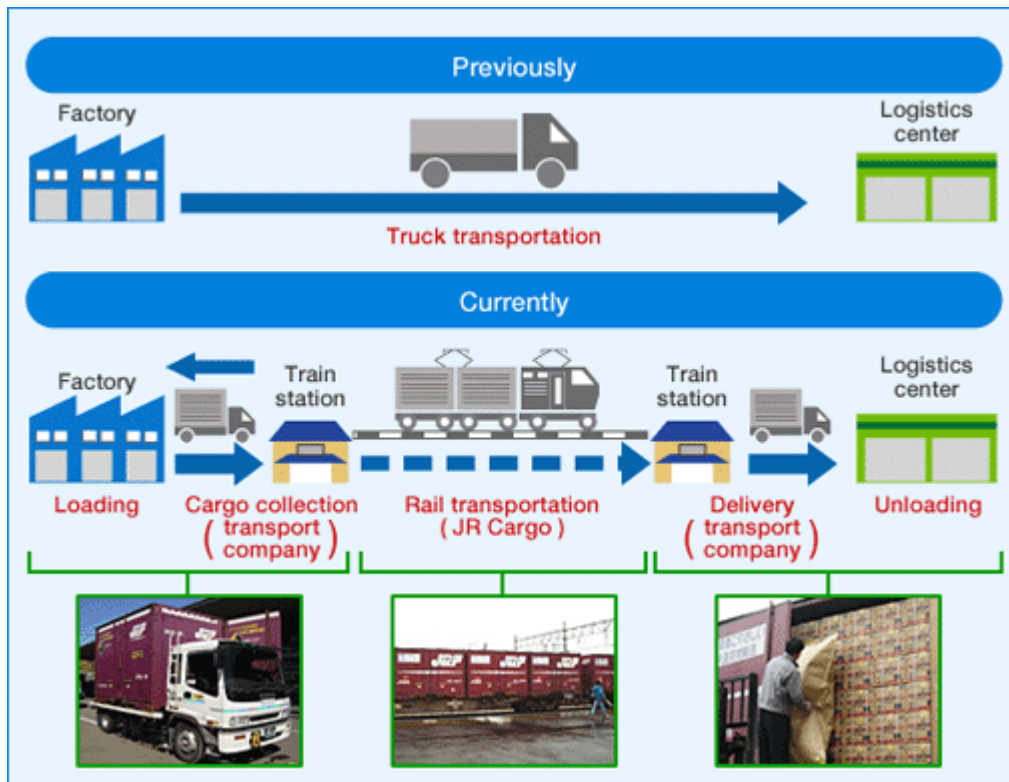

* Transportation of air conditioning equipment, residential equipment, appliances, digital media products, etc.



Reducing the Use of Disposable Packaging Materials

Targets of the 6th Environmental Plan (fiscal 2010–2012) and Progress in Fiscal 2010

Reducing the use of disposable packaging materials			
6th Environmental Plan (Fiscal 2010–2012) Fiscal 2012 Targets		Fiscal 2010	
		Results	Degree of achievement Self-assessment
Mitsubishi Electric	10% reduction per volume of shipment (base year Fiscal 2009)	3.3%	
Affiliates in Japan	10% reduction per volume of shipment (base year Fiscal 2009)	(4.6%)	
Overseas affiliates	Assessment of packaging material volume and product shipment volume	Completed assessment of packaging material volume in 22 companies and product shipment volume in 19 companies	

The Mitsubishi Electric Group has set reduction of packaging and other shipping materials as a basic policy. Toward this end, we're promoting the "3Rs" of packaging: Reduce (simplify packaging), Reuse (expand use of returnable containers and packaging), and Recycle (recycle used packaging materials).

In our 6th Environmental Plan, we have set the goal of a 10% reduction over fiscal 2009 in the amount of packaging material used per volume of shipment by Mitsubishi Electric and affiliates in Japan, to be achieved by the end of fiscal 2012. For overseas affiliates, we will set activity targets based on an assessment of packaging material volume and product shipment volume at each site.

Packaging requirements per volume of shipment: 51 (2.3% reduction from fiscal 2009)
Volume of packaging used: 48,000 tons (8,000-ton reduction from fiscal 2009)

As the economic slowdown reduced volume of shipping in fiscal 2010, and as we rethought and improved packaging methods to accommodate smaller and lighter products, the volume of packaging materials per shipment was cut by 2.3%, an 8,000-ton reduction from the last fiscal year.

Among the "3Rs" of packaging, our 6th Environmental Plan places particular focus on "Reduce", or the reduction of disposable packaging material. In fiscal 2010, we identified candidates for simplified packaging and undertook improvements in packaging design (see column below).

From fiscal 2011 we will continue making improvements to further reduce the use of packaging materials using the space ratio (see column below) as an indicator.

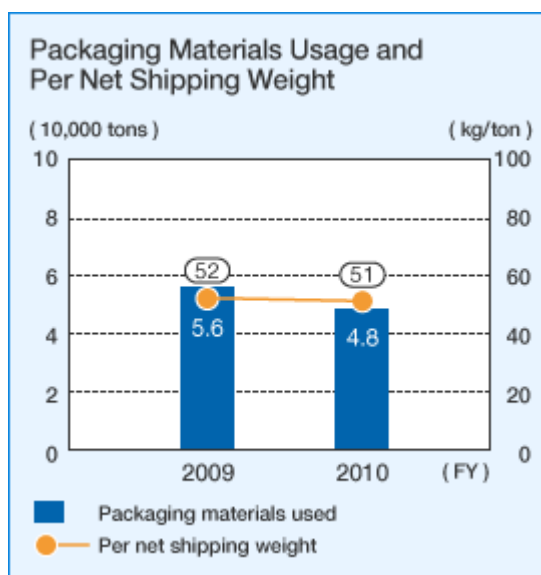

Example of Simple Packaging Eco Packaging for Japan-market ECO CUTE and Hot Water Tanks

In the past, hot water tanks were shipped with the product completely invisible, surrounded by a cardboard case. We have implemented new packaging that concentrates protection in vital areas during handling, while reducing overall packaging and making the product visible. The result both prevents dents and improves freight handling.

Former Packaging



New Packaging



What is "Space Ratio"?

Space ratio refers to a measurement of the open space between product dimensions and packaging dimensions, with a smaller number representing less waste. Package design that minimizes this space not only boosts effective use of resources but also increases the number of units carried per load, thus reducing the number of shipments and emissions of CO₂.

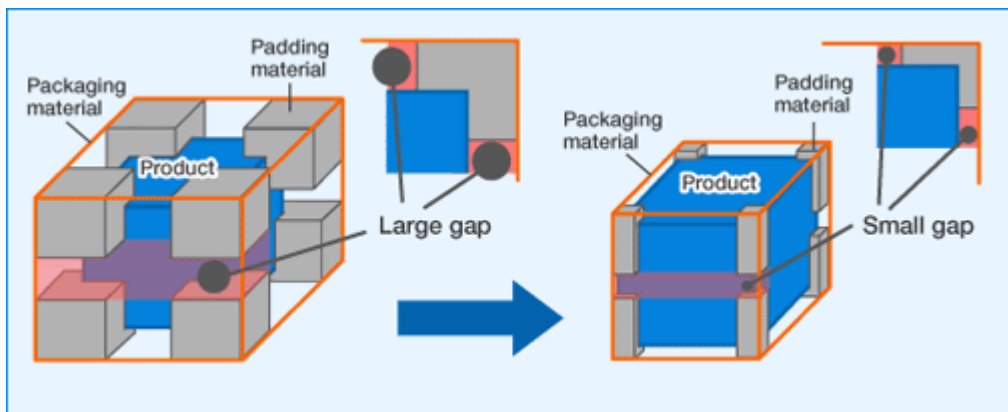

Assessing volume of packaging materials and volume of product shipments

At our overseas affiliates, we completed assessment of packaging volumes at 22 companies and product shipment volumes at 19 companies. In fiscal 2010 overseas affiliates used 53,000 tons of packaging, a 14,000-ton reduction from fiscal 2009. From here on, we will work to establish systems so that overseas companies can manage packaging volumes and achieve the same reductions per volume of product shipment that we have achieved domestically.

Respecting Biodiversity



▶ Group Biodiversity Action Guidelines

Introduction to the Mitsubishi Electric Group Biodiversity Action Guidelines established in May of 2010.

▶ Business Activities and Biodiversity

Overview of initiatives to consider biodiversity in all of our business activities and take appropriate action.

▶ Fostering Environmental Awareness

Overview of goals and fiscal 2010 initiatives and achievements in expanding our forest cultivation, "Satoyama" woodland preservation, and Mitsubishi Electric Outdoor Classroom activities.

Group Biodiversity Action Guidelines

In May of 2010, Mitsubishi Electric established its Biodiversity Action Guidelines, a step toward ensuring all Group companies consider biodiversity in all of their business activities in order to contribute to the development of a sustainable society.

News Releases

May 18, 2010

Mitsubishi Electric Group Establishes Biodiversity Action Guidelines  (26KB)

Mitsubishi Electric Group Biodiversity Action Guidelines

Respect for Biodiversity

The Earth's ecosystem is made up of the activities of diverse living organisms. All aspects of human civilization benefit from this ecosystem, but at the same time, we affect it in both direct and indirect ways. Today, damage to the ecosystem is said to be driving many species to extinction and otherwise eroding biodiversity.

Recognizing this, the Mitsubishi Electric Group has established Biodiversity Action Guidelines, which add to the Group's environmental activities aimed at the prevention of global warming and the creation of a recycling-based society from a biodiversity conservation perspective. These guidelines define the role of business activities in preserving biodiversity, and outline the Group's efforts toward social development through sustainable business activities.

Action Guidelines

Resources & Procurement

Recognizing that we utilize globally procured natural resources such as minerals, fuels, and plants, we shall aim to preserve biodiversity in Japan and around the world by carrying out green procurement activities.

Product Design

In designing our products and services, we shall promote the effective utilization of resources and the efficient use of energy, as well as aim to prevent the emission of substances that pose a risk to the environment.

Manufacturing & Transportation

When commencing or making changes to land use such as when constructing factories or warehouses, we will give due consideration to protecting the biodiversity of the land in question. And In manufacturing and transportation, we aim to minimize energy use, waste generation, and the emission of chemical substances.

Sales, Usage & Maintenance

In our sales activities, we will work to promote better understanding among our customers of the impact that product/service usage and maintenance can have on biodiversity.

Collection & Recycling

We will actively develop recycling technologies and apply them to collected end-of-life products.

Understanding & Action

We will deepen our understanding of the importance of biodiversity and our relationship to it, and will actively and voluntarily take actions necessary to coexist in harmony with nature.

Cooperation

All companies in the Mitsubishi Electric Group, including overseas affiliates, will act as one, in cooperation with local communities, NGOs, and governments.

Business Activities and Biodiversity

Considering Biodiversity in All of Our Business Activities

All human activity benefits from the workings of the diverse life forms that live on the planet. At the same time, human activity also exerts a significant impact on biodiversity, including damage to ecosystems. Now, at a time when many species face extinction, the preservation of biodiversity is a shared issue for all of humanity.

Recognizing this, Mitsubishi Electric has established Biodiversity Action Guidelines to guide the entire Group in contributing to the preservation of biodiversity. Based on these Guidelines, we will expand existing initiatives that foster environmental awareness, like our "Satoyama" woodland preservation project and the Mitsubishi Electric Outdoor Classroom. We will bolster activities that reduce environmental impact, such as green procurement and large-scale, high-purity plastic recycling.

In addition, to deepen employee understanding of biodiversity, we have created a chart that shows the relationship between business activities with biodiversity. Using this chart as a tool, we will promote renewed awareness among all domestic and overseas workplaces of the relationships between their activities and surrounding regions' ecosystems and natural environment, and link this awareness to concrete actions that contribute to communication with those regions and to the preservation of biodiversity.

Relationship between Business Activities and Biodiversity

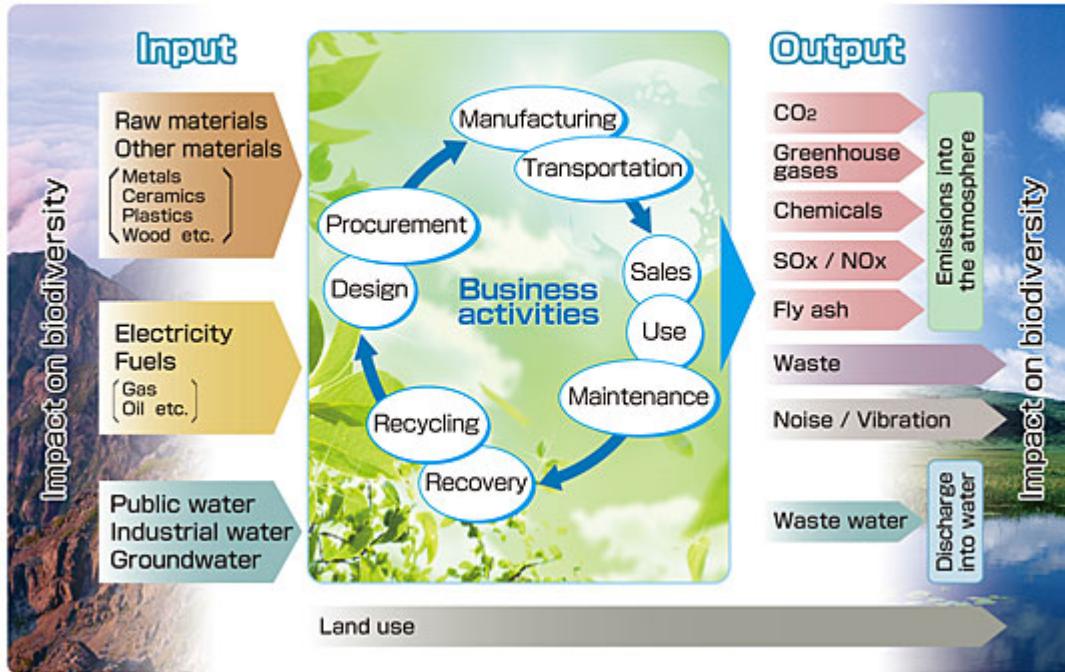

Comments from a Biodiversity Promotion Leader



Kanji Ohta
Environmental Promotion
Section

Unlike agriculture or fishing, manufacturing work has little direct interface with the ecosystem, which can make it a challenge to bring consciousness of biodiversity to the job. Yet the metals used in manufactured products are taken from mines, and the wood used in paper and packaging comes from harvested trees. I think all employees need to deeply recognize that all of our activities benefit in some way from nature, but at the same time have a major impact on the creatures that live nearby. That's why awareness is essential, and why we're now planning hands-on programs and other awareness-enhancing activities.

Rethinking our activities through the perspective of biodiversity, we should see clearly how the changes taking place in the world's ecosystems are not unconnected to our actions. For example, upon hearing news of an ecosystem-damaging incident caused by excessive mining in a country economically dependent upon that industry, we might change our behavior, to rework our designs to use that resource as effectively as possible, in as small an amount as possible. To date our company has based its activities on the concept of the "recycling-based society", which has had a connection to biodiversity. From here on, we need to move a step ahead to the stage where all employees ask what we can do to respect biodiversity, and follow that with real action. Truly understanding biodiversity is not easy. While studying more day by day, I'm working to get helpful information out and create better educational programs.

Environmental Topics: What We Can Do to Protect Biodiversity →

Respecting Biodiversity

Fostering Environmental Awareness

Targets of the 6th Environmental Plan (fiscal 2010–2012) and Fiscal 2010 Progress

Respecting Biodiversity

Forest Cultivation and "Satoyama" Woodland Preservation				
6th Environmental Plan (fiscal 2010–2012) Targets by fiscal year	Fiscal 2010			Fiscal 2011
	Target	Results	Degree of achievement Self-assessment	Target
Expand by one or more regions per year	Held in one new region, for total of five regions	Implemented according to plan		Held in one new region, for total of six regions

Mitsubishi Electric Outdoor Classroom				
6th Environmental Plan (fiscal 2010–2012) Targets by fiscal year	Fiscal 2010			Fiscal 2011
	Target	Results	Degree of achievement Self-assessment	Target
Increase by five regions per year Train 50 outdoor classroom leaders per year	Held in 5 new regions, for total of 26 times in 15 regions	Held in 9 new regions, for total of 30 times in 19 regions Trained 46 outdoor classroom leaders		Held in 5 new regions, for total of 35 times in 24 regions

Our goals include activities to help foster environmental awareness. One is to add at least one new site every year, to undertake forest cultivation and "Satoyama" woodland preservation activities, enabling employees to engage physically in nature conservation and social contribution. Another goal is to add five regions every year to our Mitsubishi Electric Outdoor Classroom program, where employees, their families, and communities come together to enjoy nature. We also plan to train 50 employees annually as Outdoor Classroom leaders.

Forest nurturing, "Satoyama" woodland preservation, and Mitsubishi Electric Outdoor Classroom activities going strong

Mitsubishi Electric sets the fostering of environmental awareness as one link in our activities to preserve biodiversity. Our company-wide initiatives fall into two main types. One is forest nurturing and "Satoyama" woodland preservation activities that enable employees and their families to engage physically in nature conservation, experience the importance of the environment, and contribute to society. The other is the Mitsubishi Electric Outdoor Classroom, which brings together employees, their families, and the local community to enjoy nature.

In our forest nurturing and "Satoyama" woodland preservation programs, we met our target with events held at five locations (company headquarters, Nagoya, Kobe, Nakatsugawa, Shizuoka).

See ["Satoyama Woodland Preservation Activities"](#) on the [Philanthropic Activities](#) page for details of this employee participatory program.

In fiscal 2010 we surpassed our target for the Mitsubishi Electric Outdoor Classroom by expanding the program to nine new regions, for a total of 30 events in 19 regions. We also trained a total of 43 new Outdoor Classroom leaders from our training classes, with three employees voluntarily taking part in leader activities (fiscal 2010 cumulative leader total: 111 persons).

As a long-term goal, we intend to extend the Mitsubishi Electric Outdoor Classroom program to all workplaces (head office, branches, manufacturing centers, etc.) by fiscal 2022. We are planning to strengthen our efforts in leader training in fiscal 2011, to address regions that currently have no Outdoor Classroom leaders. To enhance the content of the program, we are working on better means of sharing information about the Outdoor Classrooms, such as offering information online and using regional conferences to exchange information and coordinate activities.

Our affiliated companies are engaged in [environmental conservation activities](#) as well. In Japan, a total of 121 participants from Mitsubishi Electric and 13 affiliates took part in the Earth-Friendly Cleanup Activities hosted by Fukuoka City. Overseas, our programs included coastal preservation in Thailand through mangrove planting, and planting one tree in highway median strips for each elevator we sold.

Expanding Mitsubishi Electric Outdoor Classrooms with domestic and overseas affiliates in fiscal 2011

We are making plans to have affiliates start hosting Mitsubishi Electric Outdoor Classrooms, and to foster Outdoor Classroom leaders within affiliates in Japan in fiscal 2011. We will also coordinate with four locations in the U.S., Europe, Asia, and China to take Outdoor Classrooms overseas.

Example of "Satoyama" Woodland Preservation Projects and Mitsubishi Electric Outdoor Classrooms

At our Shizuoka Works we initiated cleanup efforts along the Abe River, convening an Outdoor Classroom beforehand. Children who learned about the plants and trees of the area and the workings of the ecosystem found the cleanup activity a lot of fun. Together they searched for litter, learning consideration for the grasses and flowers decorating the riverbanks. The separation of the litter, as well as the sheer volume of what they collected, was of further interest to the children.



Example of Mitsubishi Electric Outdoor Classroom

An former quarry hosted the Outdoor Classroom held by our Kamakura Works. The mountain, laid bare where rock had been cut away decades ago, was welcoming back birds and rich greenery thanks to the efforts of the local people. With the greenery as their textbook, the children had fun discovering the secrets of the red berries they saw, learning how fallen leaves become soil, and much more. They also learned that the mica beneath their feet is a mineral with a deep connection to the products we build.

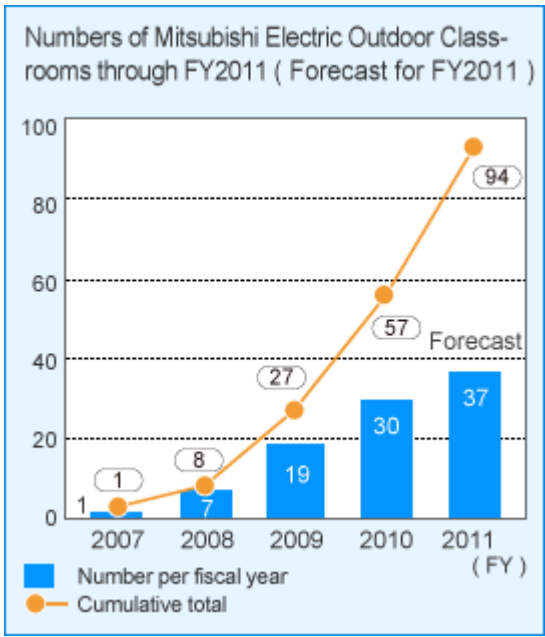
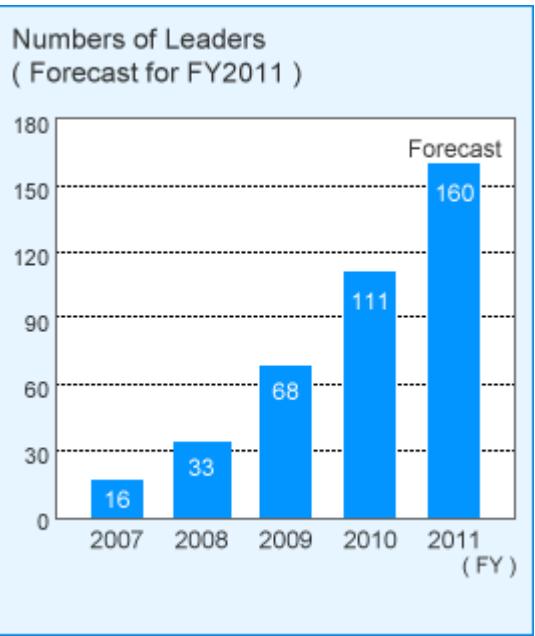

Environmental Report

Data & Charts



▶ Scope of Report

Overview of reporting period and scope.

▶ Material Balance

Report on the environmental impacts that accompany our business activities, following the lifecycle of "factory", "logistics", "product", and "recycle".

▶ Environmental Accounting

Report on fiscal 2010 totals, calculated under the Environmental Accounting Guidelines (2005 version) by the Ministry of the Environment.

▶ Environmental Performance Data

Data on the results of fiscal 2010 activities, examples of domestic and overseas activities related to respecting biodiversity, and participation in exhibitions and events.

▶ Awards

Awards received In Japan and overseas.

Scope of Report

Mitsubishi Electric reports on environmental matters in two-parts: the Environmental Report and Environmental Topics.

Environmental Report

Fiscal 2010 marked the first year of the 6th Environmental Plan (fiscal 2010–2012). Taking a "back-casting" approach to achieve the goals of Environmental Vision 2021, the Plan sets points of emphasis and gives concrete targets to each initiative. The Environmental Report covers targets, activities, and achievements in fiscal 2010 based on the PDCA cycle, and even touches upon topics for fiscal 2012, the last year of the Plan. (There are also activities which are not contained within the 6th Environmental Plan but which we naturally undertake as steps toward the realization of a sustainable society. These too are addressed under the PDCA focus of the Report.)

Period Covered

April 1, 2009 to March 31, 2010

* The report also includes some information on policies, targets and plans for fiscal 2011 and beyond.

Scope of Report

Mitsubishi Electric Group (Mitsubishi Electric Corporation and 163 affiliates in Japan and overseas)

* Environmental management and environment governance are key aspects of the business management of the Mitsubishi Electric Group. [The scope of our environmental management system](#) extends to Mitsubishi Electric, its consolidated subsidiaries, and its affiliated companies. The fiscal 2010 Environmental Report covers Mitsubishi Electric Corporation and 163 group companies in Japan and overseas. Up to fiscal 2009, from an environmental governance perspective, the scope of our report was limited to those companies that had drawn up an environmental plan. But in line with the policy of [expanding global environmental management](#) under the 6th Environmental Plan, we've broadened the scope of the report to cover all companies.

Environmental Topics

This section introduces notably successful examples drawn from our many initiatives to achieve the goals of Environmental Vision 2021, and offers easy-to-understand animated content to explain our environmental technologies. Other fiscal 2010 content includes an idea exchange meeting with an expert invited by Mitsubishi Electric to help strengthen and propel our initiatives to respect biodiversity.

We embrace our responsibility to engage society and expand the circle of our communication with all stakeholders. We would greatly appreciate your honest opinions and encouragement.

Inquiries

We accept inquiries via the [the contact form](#).

Material Balance

Overall Environmental Impact

Period: April 1, 2009 - March 31, 2010

Scope of Data Compilation : Mitsubishi Electric Group (Mitsubishi Electric and 163 affiliates in Japan and overseas)



IN

Materials for Manufacturing			
	Mitsubishi Electric	Affiliates (Japan)	Affiliates (Overseas)
Materials ¹	510,000 tons	90,000 tons	420,000 tons
Manufacturing			
Electricity	960 million kWh	320 million kWh	245 million kWh
Natural gas	20,700,000 m ³	2,850,000 m ³	8,510,000 m ³
LPG	1,903 tons	2,119 tons	1,373 tons
Oil (crude oil equivalent)	6,146 kl	2,763 kl	651 kl
Water	6,530,000 m ³	2,120,000 m ³	1,550,000 m ³
Public water	1,280,000 m ³	480,000 m ³	380,000 m ³
Industrial water	2,030,000 m ³	280,000 m ³	970,000 m ³
Groundwater	3,220,000 m ³	1,360,000 m ³	50,000 m ³
Others	0 m ³	0 m ³	190,000 m ³
Reuse of water	3,050,000 m ³	1,530,000 m ³	100,000 m ³
Controlled chemical substances (amounts handled)	5,012.7 tons	1,885.2 tons	4,172.7 tons
Ozone depleting substances (amounts handled)	0.3 tons	146.2 tons	1,438.7 tons
Greenhouse gases (amounts handled)	2,667.3 tons	92.1 tons	1,167.4 tons
Volatile organic compounds (amounts handled)	1,474.3 tons	950.0 tons	147.5 tons

1: Materials: Sum of shipping weight of "Design for Environment" (DfE) products, plus amount of product packaging materials used, plus total amount of waste



OUT

Emissions (From Manufacturing)				
		Mitsubishi Electric	Affiliates (Japan)	Affiliates (Overseas)
Discharge into water	Water	6,290,000 m ³	1,350,000 m ³	1,020,000 m ³
	Controlled chemical substances	13.0 tons	1.8 tons	43.0 tons
	BOD (biological oxygen demand)	89.9 tons	4.2 tons	17.5 tons
	COD (chemical oxygen demand)	20.0 tons	3.6 tons	37.0 tons
	Nitrogen	91.2 tons	11.8 tons	0.2 tons
	Phosphorus	7.2 tons	0.1 tons	0.2 tons
	Suspended solids	64.7 tons	2.1 tons	20.8 tons
	n-hexane extracts (mineral)	2.3 tons	0.2 tons	0.9 tons
	n-hexane extracts (active)	1.3 tons	0.0 tons	0.2 tons
	Total emissions of zinc	0.2 tons	0.0 tons	0.0 tons
Emissions into the atmosphere	Carbon dioxide(CO ₂)	472,000 tons-CO ₂	166,000 tons-CO ₂	217,000 tons-CO ₂
	Controlled chemical substances (excluding amounts contained in other waste)	644.9 tons	66.3 tons	92.8 tons
	Ozone depleting substances	0.00 ODP t	0.00 ODP t	0.04 ODP t
	Greenhouse gases	150,000 tons-CO ₂	57,000 tons-CO ₂	63,000 tons-CO ₂
	Volatile organic compounds	498.4 tons	64.8 tons	14.2 tons
	Sulfur oxide (SO _x)	1.3 tons	4.1 tons	4.4 tons
	Nitrogen oxide (NO _x)	33.1 tons	11.3 tons	33.2 tons
	Fly ash	1.1 tons	0.7 tons	11.2 tons
Amount of CFCs recovered		0.2 tons	77.6 tons	—
Waste				
Total waste emissions		74,980 tons	50,155 tons	46,317 tons
Amount recycled		63,116 tons	43,332 tons	35,812 tons
Waste treatment subcontracted out		18,982 tons	30,762 tons	7,575 tons
Final disposal		32 tons	107 tons	1,496 tons
In-house weight reduction		2,011 tons	0 tons	0 tons
Product ²				
Weight of all "DfE" Products sold		393,000 tons	34,000 tons	317,000 tons
Weight of packaging materials		41,000 tons	7,000 tons	53,000 tons

2: Products: Weight related to products designed for the environment



IN

Selling and Distribution ³			
	Mitsubishi Electric	Affiliates (Japan)	Affiliates (Overseas)
Fuel for trucks (gasoline)	10,500 kl	1,200 kl	170 kl
Fuel for trucks (diesel)	25,000 kl	6,500 kl	24,500 kl
Fuel for rail (electricity)	1,900 MWh	400 MWh	0 MWh
Fuel for marine transport (bunker oil)	350 kl	20 kl	28,500 kl
Fuel for air transport (jet fuel)	450 kl	200 kl	14,500 kl

3: Sales and logistics: Includes 11 sales companies in Japan. Figures for overseas affiliated companies include transportation between countries.



OUT

Emissions ⁴			
	Mitsubishi Electric	Affiliates (Japan)	Affiliates (Overseas)
Carbon dioxide (CO ₂)	92,000 tons-CO ₂	20,000 tons-CO ₂	177,000 tons-CO ₂

4: Emissions: Includes 11 sales companies in Japan. Figures for overseas affiliated companies include transportation between countries.

IN

Energy Consumption ⁵			
	Mitsubishi Electric	Affiliates (Japan)	Affiliates (Overseas)
Annual power consumption from use of "Design for Environment" (DfE) products	7,530 million kWh	780 million kWh	9,880 million kWh

5: Energy Consumption: Amount related to "Design for Environment" (DfE) products



OUT

Emissions ⁶			
	Mitsubishi Electric	Affiliates (Japan)	Affiliates (Overseas)
Annual CO ₂ emissions from use of "Design for the Environment" (DfE) products (corresponding value)	3,178,000 tons-CO ₂	329,000 tons-CO ₂	—

6: Emissions: Amount related to "Design for Environment" (DfE) products



IN

End-of-Life Products ⁷	
	Mitsubishi Electric
Air conditioners	12,038 tons
Televisions	20,399 tons
Refrigerators	19,922 tons
Washing machines / Clothes dryers	6,559 tons
Personal computers	47 tons

7: End-of-Life Products: Weight of products taken back and weight of recovered resources of four types of appliances subject to Japan's Home Appliance Recycling Law, plus personal computers



OUT

Resources Recovered ⁸	
	Mitsubishi Electric
Metals	27,645 tons
Glass	10,608 tons
CFCs	274 tons
Others	12,459 tons

8: Resources Recovered: Weight of products taken back and weight of recovered resources of four types of appliances subject to Japan's Home Appliance Recycling Law, plus personal computers

Environmental Accounting

Scope and Period of Data Compilation and Basis of Calculation

Scope and Period of Data Compilation

- Period: April 1, 2009 – March 31, 2010
- Scope of Data Compilation: Mitsubishi Electric Corporation and 163 of its domestic and overseas affiliates and subsidiaries

*The scope of data compilation is the same as the scope covered in this Environmental Report.

Basis of Calculation

- Data is calculated for environmental conservation costs, environmental conservation benefits (environmental performance) and economic benefits from environmental conservation activities (actual profit or cost-saving benefits) in accordance with the Environmental Accounting Guidelines (fiscal 2006 edition) issued by Japan's Ministry of the Environment.
- Economic benefits are ascertained in terms of real benefits, which consist of earnings and savings, and estimated benefits. Estimated benefits include the economic benefits to customers of using our products, such as lower electricity bills, and environmental improvements produced outside our business sites.

* Environmental conservation costs reflect straight-line depreciation for capital investments made over the past five years and assumed to have useful lives of five years. The annual benefits of earnings and savings attributable to capital investments, too, are assumed to have resulted from investments over the past five years.

* For comparisons to the previous year, the previous year's data has also been revised to reflect changes in the scope/range of data.

Environmental Conservation Costs

In fiscal 2010, capital investments increased slightly compared to the previous year but expenditures decreased somewhat.

■ **Capital Investments**

Capital investments in facilities for the entire Mitsubishi Electric Group were ¥5 billion (¥300 million increase over the previous year). Within the company itself the figure was ¥3.2 billion (¥300 million more than the previous year). Investments increased markedly for improvements in product efficiency, research and development of energy conservation technologies and reduction of chemical substances used. Also, as in the previous year, we continued to invest aggressively in high-efficiency equipment, energy conservation support equipment and the introduction of photovoltaic power generation.

■ **Expenditures**

Expenditures for the company itself were ¥850 million, less than the previous year at ¥15.8 billion. For the Mitsubishi Electric Group, expenditures came to ¥21.1 billion. However expenses increased for research and development of environmental technologies such as high-performance power modules, air and water purification technologies, high efficiency Photovoltaic cells and energy-saving appliances, etc. In addition, money was spent to conduct groundwater and soil surveys in connection with building upgrades and yard construction, and on responses to results.

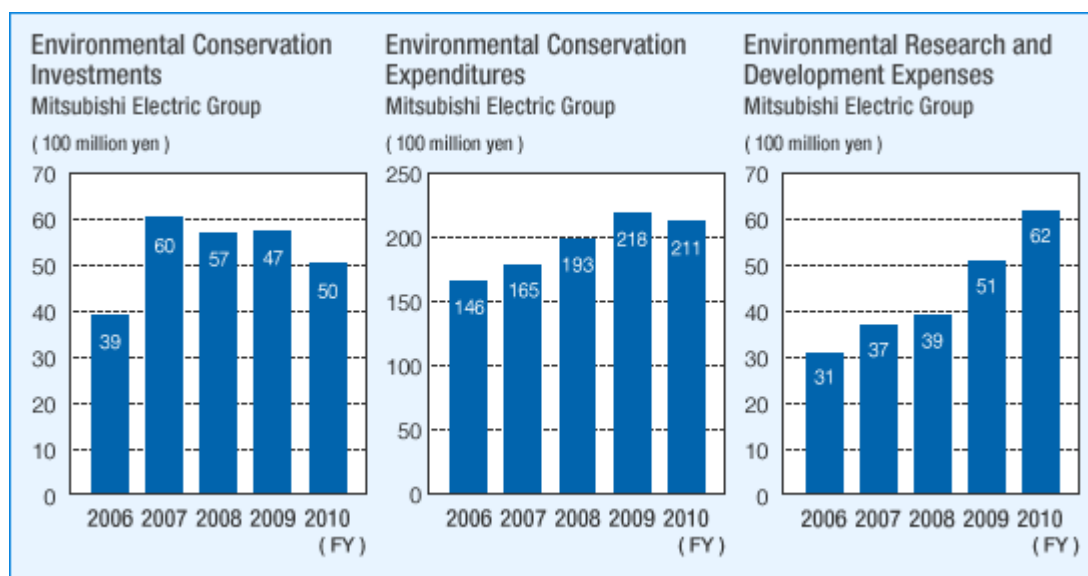

Environmental Conservation Benefits (Environmental Performance)

In fiscal 2010, because there were more companies being inspected, the total amount of waste disposed of overseas increased when compared to the previous year. In all other figures, for the company itself and the Mitsubishi Electric Group, total volumes decreased for all other figures. Units of net sales also decreased for all items due to lower sales compared to the previous year.

Economic Benefits from Environmental Conservation Activities (Actual Benefits)

The real benefits increased for the company itself and Mitsubishi Electric Group for cost saving measures, although gain on sale of valuable resources decreased due to reduction in product input.

Economic Benefits from Environmental Considerations in Products and Services (Estimated Benefits)

The application of commercial ventilator/cleaner products (Lossnay), photovoltaic systems, combined cycle thermoelectric generation stations, along with energy- saving refrigerators, air conditioners and elevators and low consumption power supply modules (CE power supply) has produced benefits in terms of utility savings for our customers and environmental improvements.

■ Environmental Conservation Costs

Top figure: Mitsubishi Electric Group (consolidated basis) / Bottom figure : Mitsubishi Electric / Unit: 100 million yen

Item	Capital Investment	Costs*	Year-on-Year Change	Main Costs
Business Area Activities	38.9	101.6	(2.6)	
	25.9	62.1	(2.3)	
Pollution Prevention	3.4	31.2	(12.2)	Replacement and maintenance of ventilation and wastewater treatment facilities and investment for replacement of vehicles to meet regulatory requirements, etc.
	1.1	18.5	(6.5)	
Global Environmental Conservation	33.5	36.0	3.6	Investment for conversion to high-efficiency equipment such as air conditioners, freezers, lighting, and introduction of photovoltaic systems and energy monitoring systems, etc.
	23.3	24.6	2.3	
Resource Recycling	2.0	34.4	6.0	Cost for processing industrial waste and recycling scraps, paper, cardboard, etc.
	1.5	19.0	1.9	
Green purchasing/procurement and product-related activities at upstream/downstream of production	7.2	10.9	(2.4)	Investigation of environmentally hazardous substances in products and trial manufacture/evaluation of replacement materials, etc.
	2.7	8.0	(3.0)	
Management Activities	0.2	32.2	(5.8)	Environmental education, EMS (Environmental Management System) activities, environmental exhibition, greening of premises, etc.
	0.0	23.5	(7.4)	
R&D activities toward reducing environmental impact	3.2	61.9	10.6	Technological development to enhance photovoltaic cell efficiency, and development of high efficiency power modules, energy-saving equipment/ applications technology, and next generation plastic recycling technology, etc.
	3.1	60.3	10.8	
Social Activities	0.0	1.2	0.0	On/off-site clean-up activities, maintenance of plants in the factory
	0.0	1.0	0.0	
Environmental Damage	0.3	3.1	(6.6)	Surveys on the contamination and purification of soil or groundwater
	0.3	3.1	(6.6)	
Total	49.8	210.9	(6.8)	
	32.0	158.0	(8.5)	
Year-on-Year Change	2.9	(6.8)		
	2.8	(8.5)		

* Includes depreciation of capital investment over the past five years.

■ Environmental Conservation Benefits (Environmental Performance)

Top figure: Mitsubishi Electric Group (consolidated basis) / Bottom figure : Mitsubishi Electric / Unit: 100 million

Item	Unit	Fiscal 2009 Results	Year-on-Year Change	Year-on-Year Per Net Sales
Total energy used	10,000 GJ	1,668	(232)	96%
		1,054	(87)	102%
Total water used	10,000 m ³	1,020	(146)	96%
		653	(77)	99%
Total greenhouse gas emissions	10,000 tons CO ₂	112	(26)	89%
		62	(15)	89%
CO ₂ (Energy Consumption)	10,000 tons CO ₂	85	(10)	98%
		47	(4)	101%
HFC,PFC,SF ₆	10,000 tons CO ₂	27	(17)	68%
		15	(10)	65%
Total atmospheric releases and transfers of chemical substances	tons	804	(133)	94%
		645	(57)	101%
Total wastewater discharged	10,000 m ³	857	(96)	98%
		629	(49)	102%
Total releases and transfers of chemical substances in the water and soil.	tons	58	(17)	84%
		13	(0)	107%
Total waste discharged	tons	171,452	756	110%
		74,980	(6,821)	101%
Final disposal	tons	1,635	(1,305)	61%
		32	(89)	30%

■ Environmental Conservation Benefits (Actual Benefits)

Top figure: Mitsubishi Electric Group (consolidated basis) / Bottom figure : Mitsubishi Electric / Unit: 100 million yen

	Amount	Year-on-Year Change	Main Benefits
Earnings	24.3	(19.2)	Profit on the sale of saleable materials such as the recycling of metal and paper scrap
	10.2	(14.2)	
Savings	74.5	34.5	Reduced electricity bills by introducing high-efficiency equipment, reuse of waste materials, and productivity improvements, and a reduction in the use of wood packaging materials by using returnable packaging materials.
	48.4	29.5	
Total	98.8	15.3	
	58.6	15.3	

■ Economic Benefits from Environmental Consideration in Products and Services (Estimated Benefits)

Top figure: Mitsubishi Electric Group (consolidated basis)/ Bottom figure : Mitsubishi Electric / Unit: 100 million yen

	Amount	Main Products
Economic Benefits to Customers	2,555.7	Improvement in air conditioning equipment, total heat exchange ventilators (Lossnay), photovoltaic systems , thermoelectric generation stations, etc.
	2,542.5	
Environmental Improvements	72.9	
	71.7	

Environmental Performance Data

Results of Activities in Fiscal 2010

Eco-products share of Mitsubishi Electric's total production
Plan for reducing CO₂ from product usage under Environmental Vision 2021
Plan for reducing resource inputs under Environmental Vision 2021
Mitsubishi Electric nationwide product recycling results in Japan
Groupwide plan to reduce CO₂ from production
Total CO₂ emissions [Mitsubishi Electric]
Breakdown of energy usage (CO₂ conversion) [Mitsubishi Electric]
Total CO₂ emissions (CO₂ conversion) [Affiliates in Japan]
Breakdown of energy usage (CO₂ conversion) [Affiliates in Japan]
Total CO₂ emissions (CO₂ conversion) [Overseas affiliates]
Breakdown of energy usage (CO₂ conversion) [Overseas affiliates]
Emissions of non-CO₂ greenhouse gases
Total waste output [Mitsubishi Electric Group]
Total waste output [Mitsubishi Electric]
Total waste output [Affiliates in Japan]
Total waste output [Overseas affiliates]
Breakdown of water usage
Total water usage
Water recycling ratio
VOC emissions reductions
Emissions of CO₂ from logistics [Mitsubishi Electric / Affiliates in Japan]
Fiscal 2010 share of transport by mode [Mitsubishi Electric / Affiliates in Japan]
Emissions of CO₂ from logistics [Mitsubishi Electric]
Fiscal 2010 share of transport by mode [Mitsubishi Electric]
Packaging materials usage and per net shipping weight
Number of classroom leaders trained
Actual and planned number of outdoor classrooms
Environmental accounting

Respecting Biodiversity (Japan)

Mitsubishi Electric outdoor classroom sessions

Mitsubishi Electric

Affiliates in Japan

Leadership training course sessions

"Satoyama" woodland preservation activities initiative results

Mitsubishi Electric

Affiliates in Japan

Other environmental activities (Nature preservation, environmental philanthropic activities, biodiversity awareness activities etc.)

Mitsubishi Electric

Affiliates in Japan

Supporting the nature preservation and environmental philanthropic activities of NGOs / NPOs (human resources, financial, other)

Mitsubishi Electric

Affiliates in Japan

Respecting Biodiversity (Overseas)

Nature preservation, environmental philanthropic activities, biodiversity awareness activities etc.

Supporting the nature preservation and environmental philanthropic activities of NGOs / NPOs (human resources, financial, other)

Exhibitions / Events

Non-Mitsubishi Electric exhibitions and events

Mitsubishi Electric exhibitions and events

Design for Environment

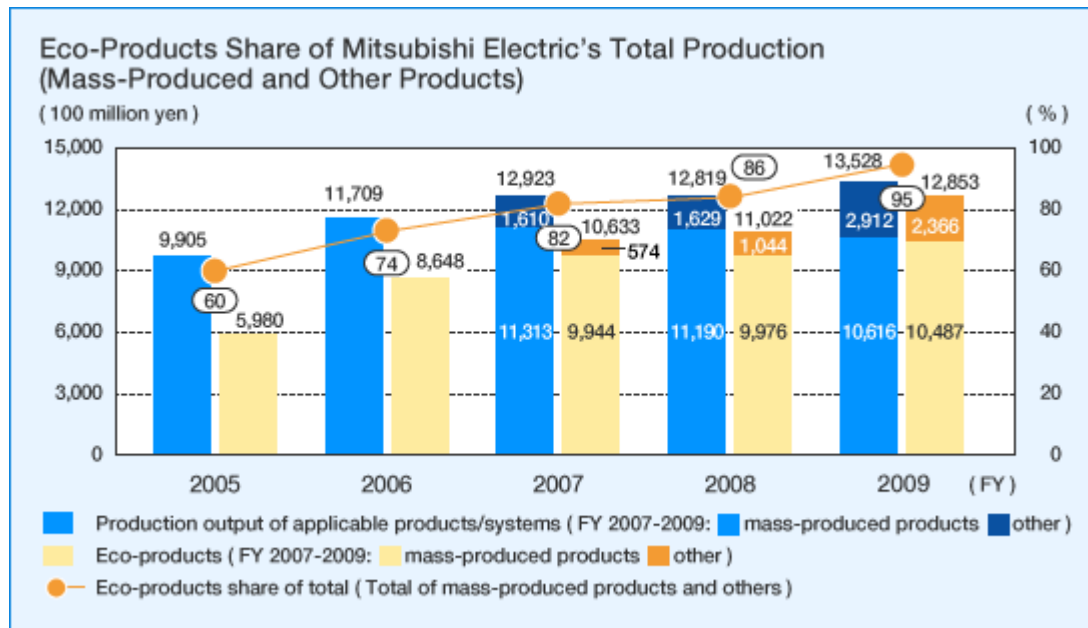

Reducing CO2 from Product Usage

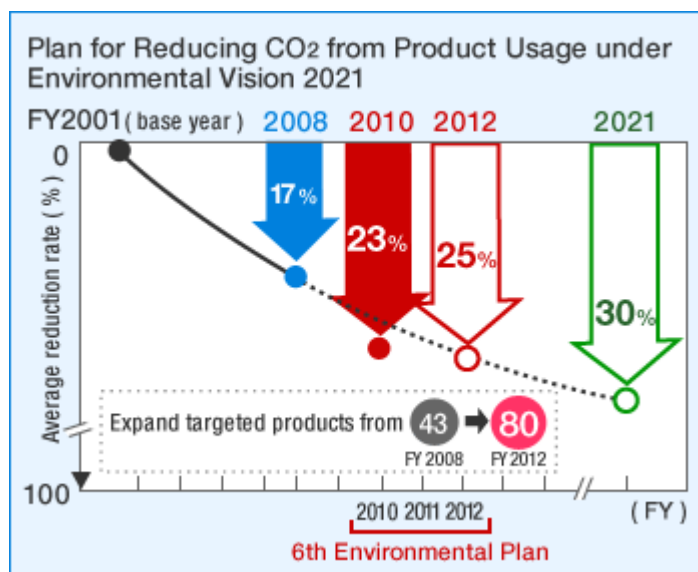

Reducing Resource Inputs

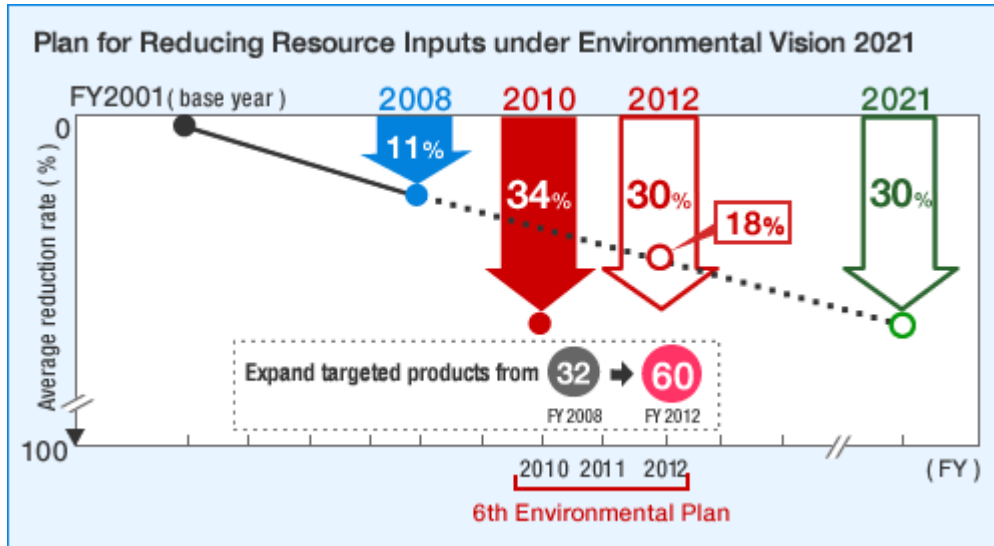

Recycling End-of-Life Products

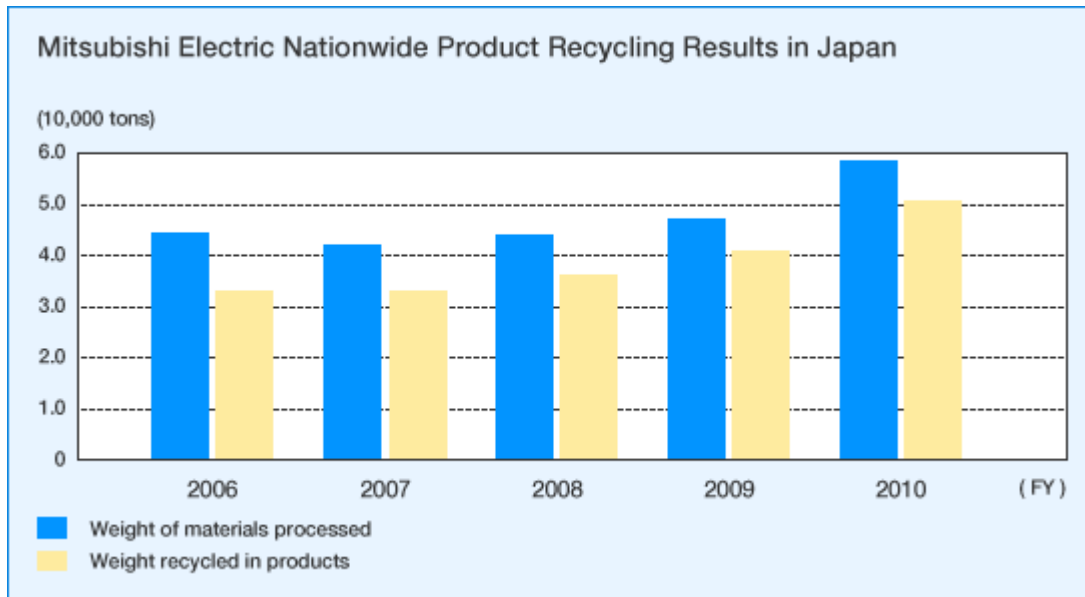

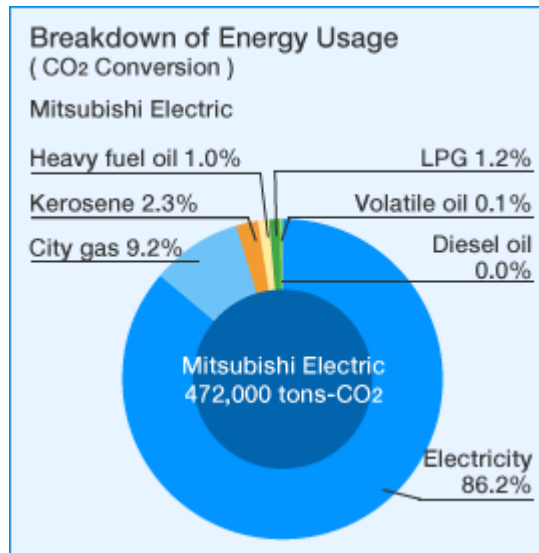
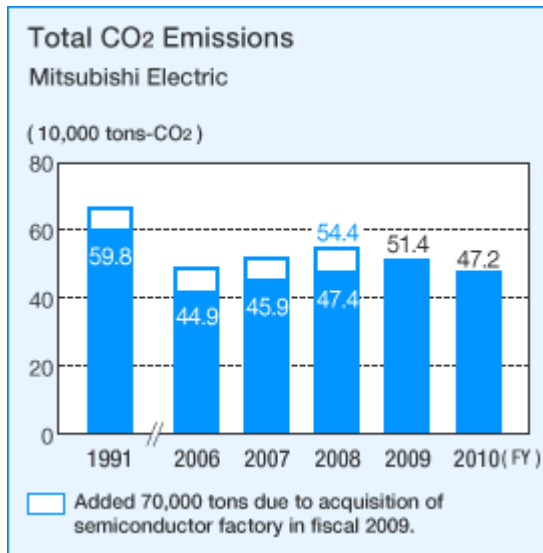
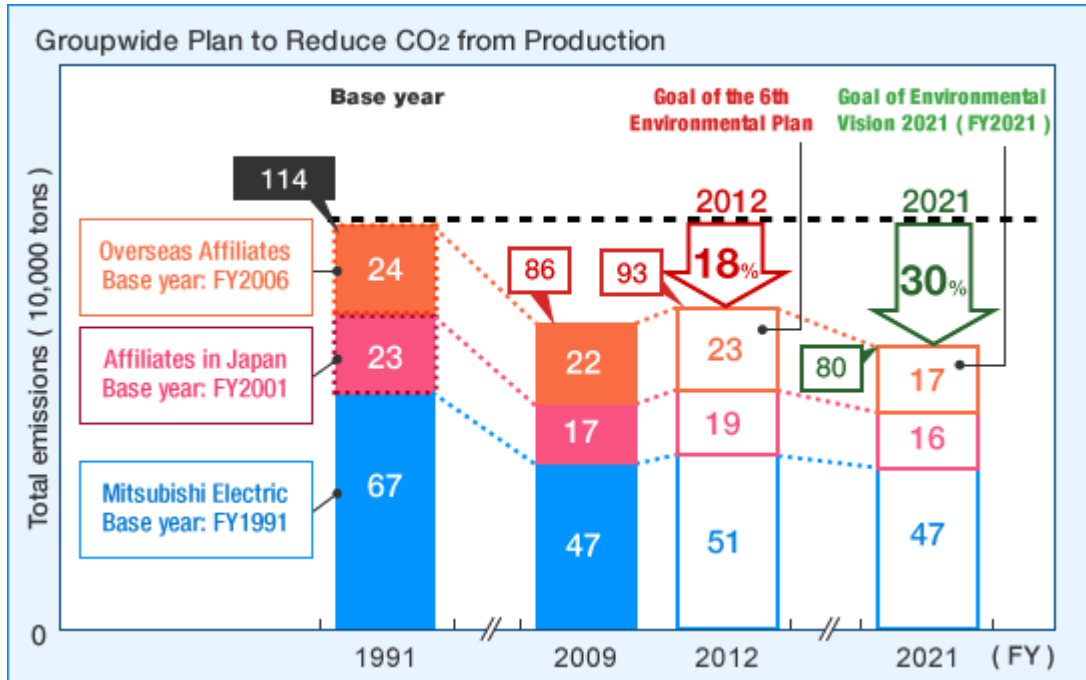

Total CO2 Emissions

Affiliates in Japan

(10,000 tons-CO₂)

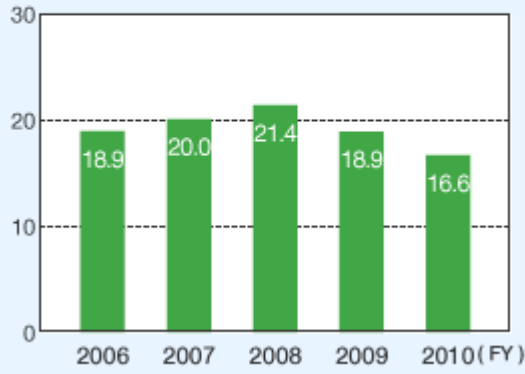

Breakdown of Energy Usage (CO₂ Conversion)

Affiliates in Japan

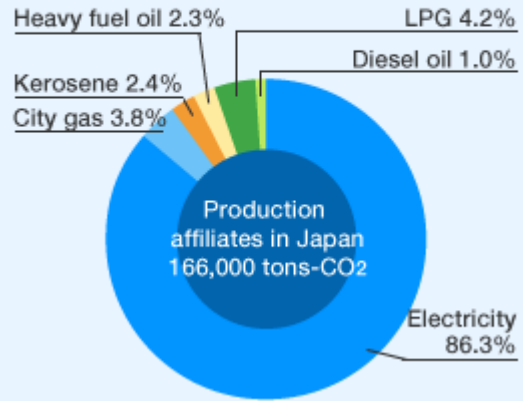

Total CO2 Emissions

Overseas Affiliates

(10,000 tons-CO₂)

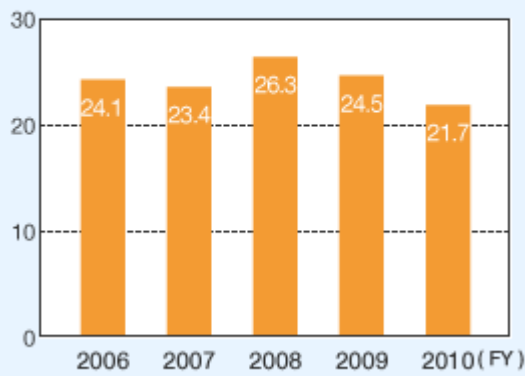

Breakdown of Energy Usage (CO₂ Conversion)

Overseas Affiliates

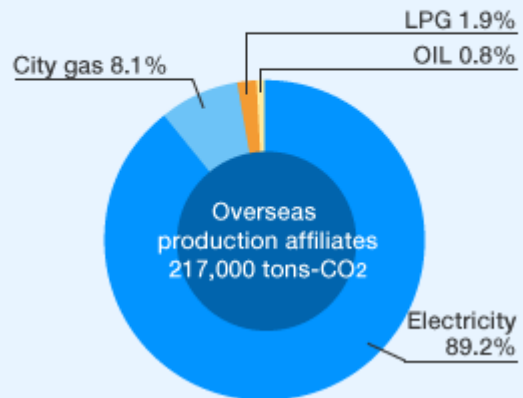

Reducing Emissions of Non-CO2 Greenhouse Gases

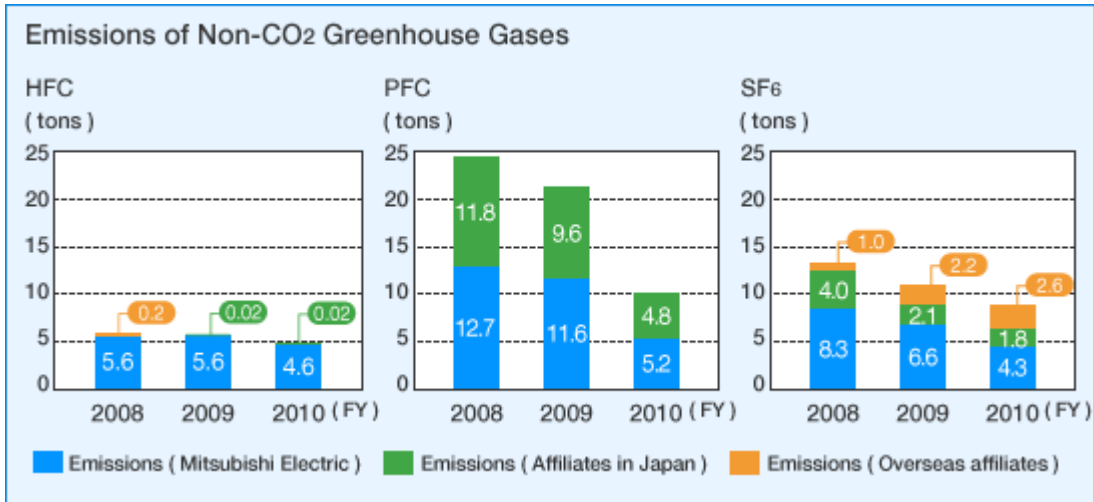

Zero Emissions

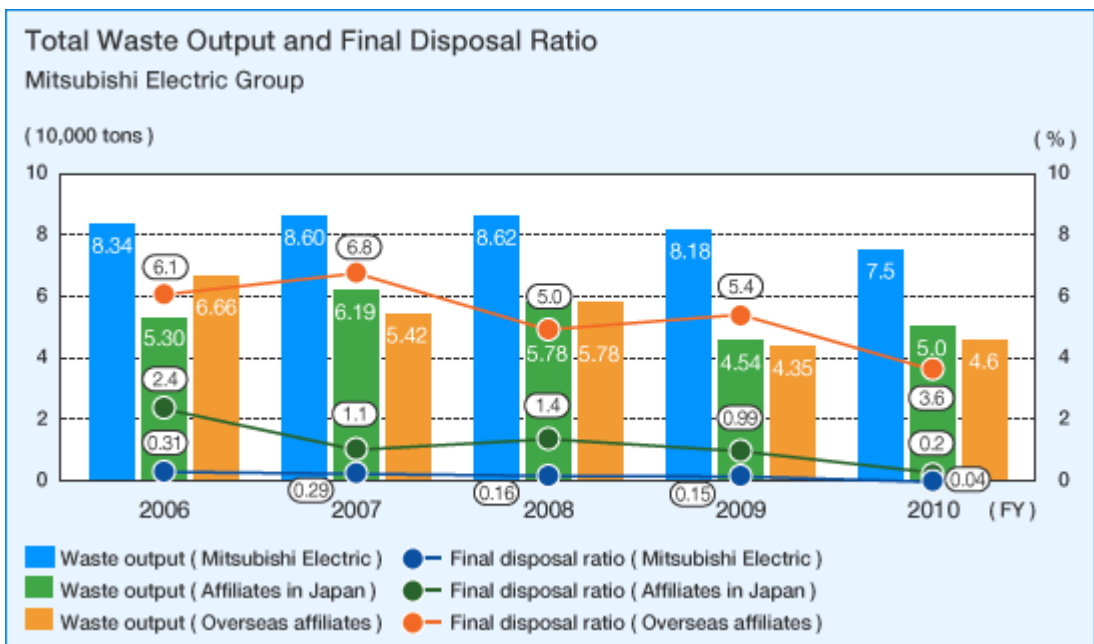

Total Waste Output

Mitsubishi Electric



Total Waste Output

Affiliates in Japan

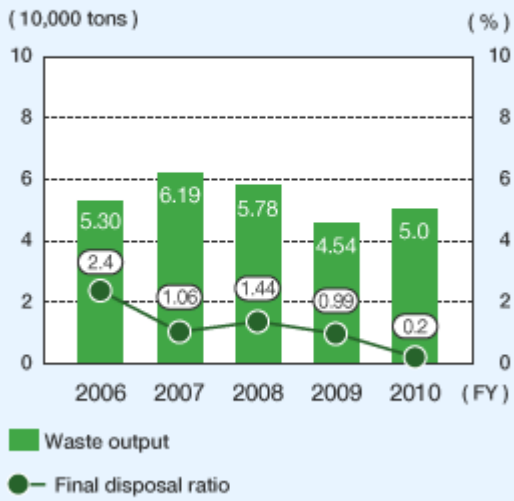

Total Waste Output

Overseas affiliates

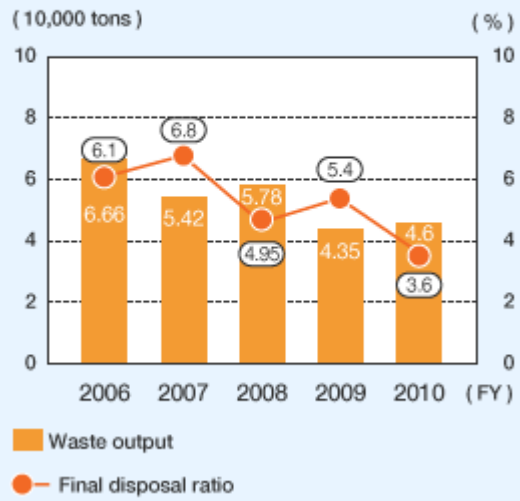

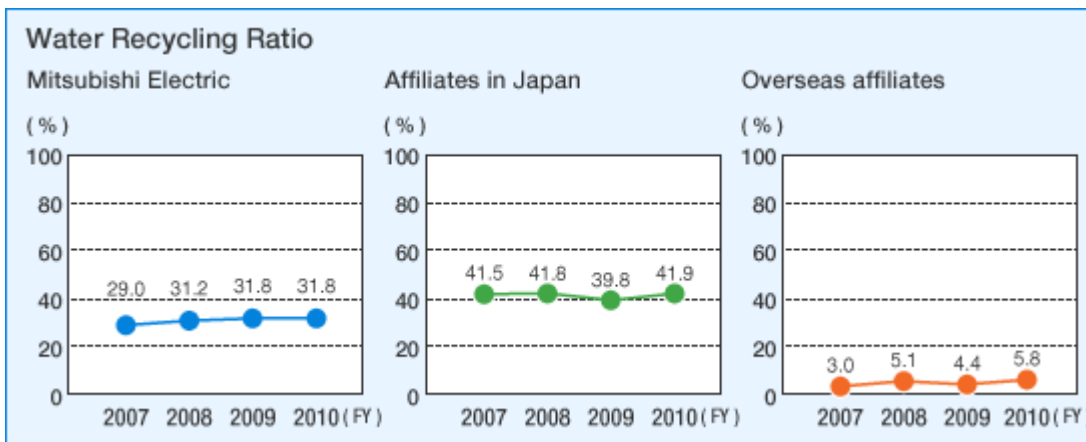
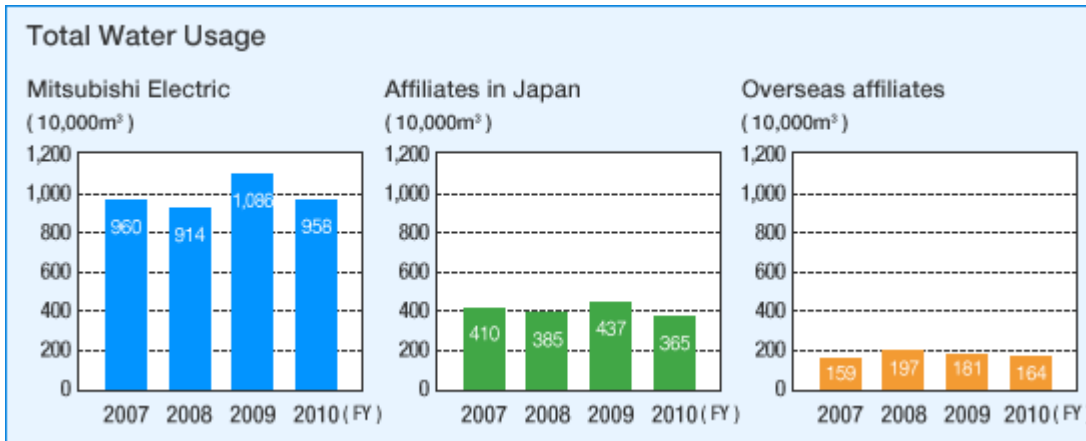
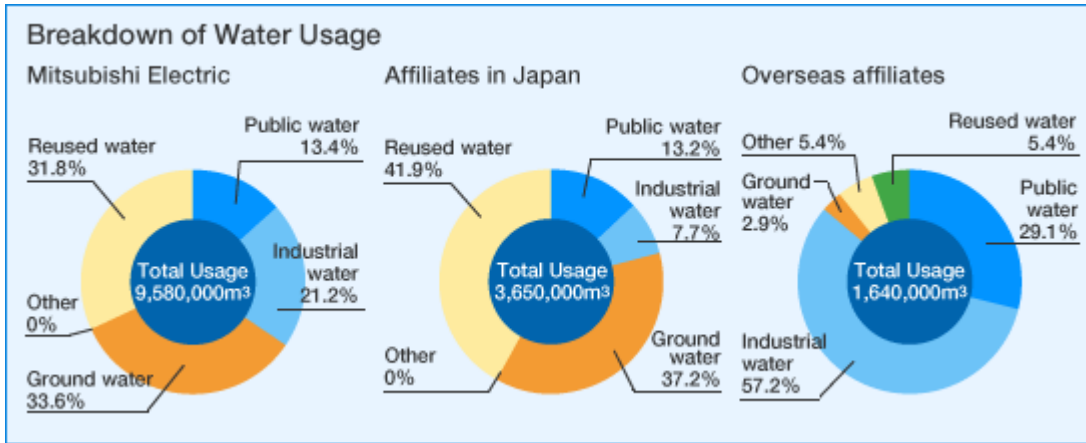

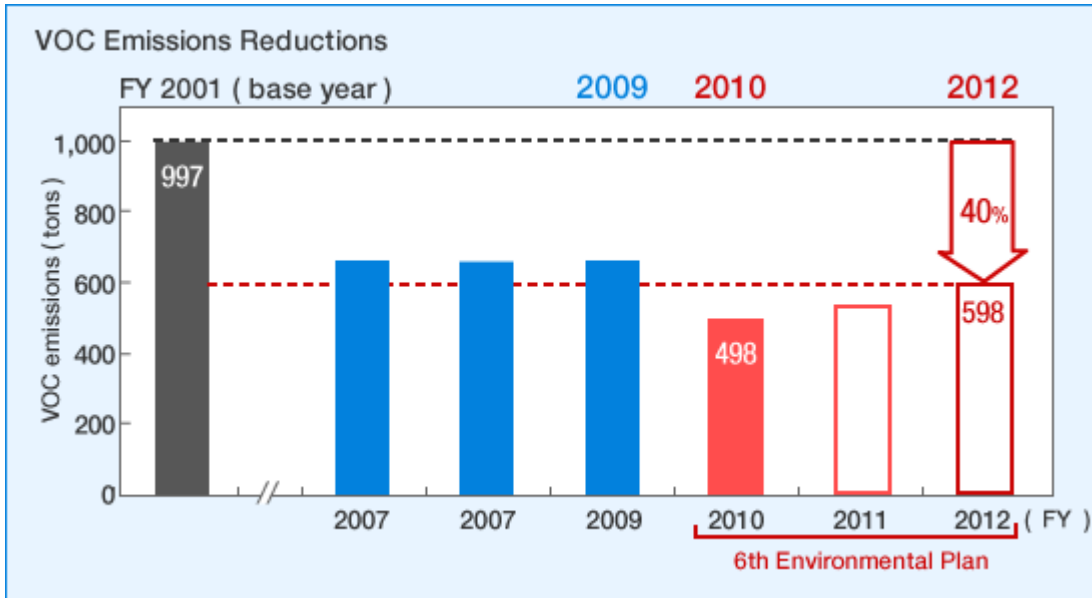

Total CO2 Emissions
Mitsubishi Electric / Affiliates in Japan

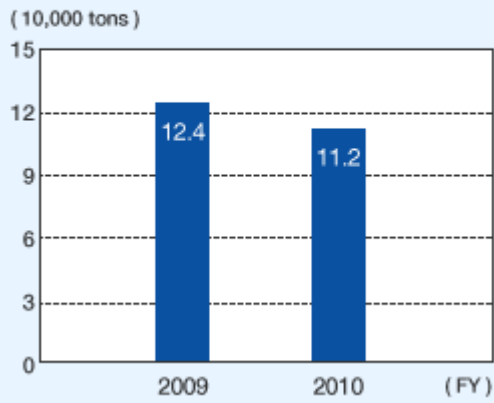

Fiscal 2010 Share of Transport by Mode
Mitsubishi Electric / Affiliates in Japan

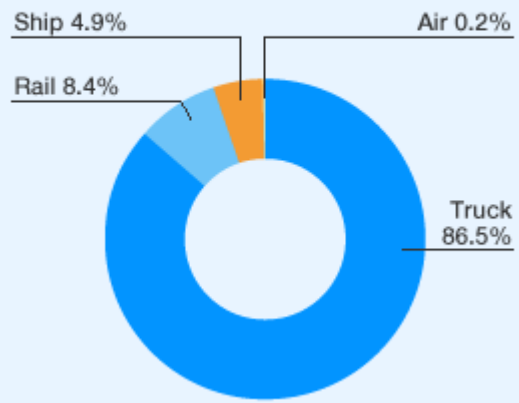

Total CO2 Emissions
Mitsubishi Electric

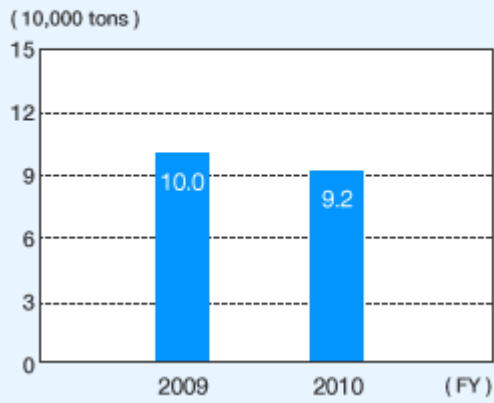

Fiscal 2010 Share of Transport by Mode
Mitsubishi Electric

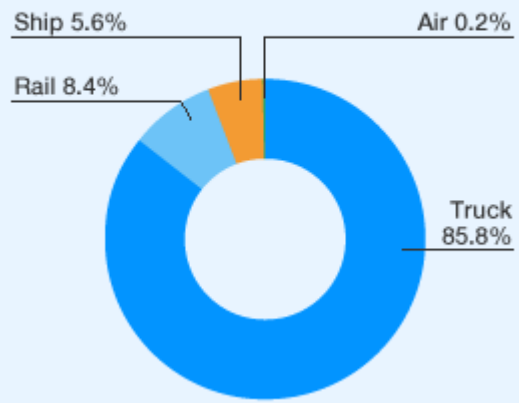

Reducing the Use of Disposable Packaging Materials

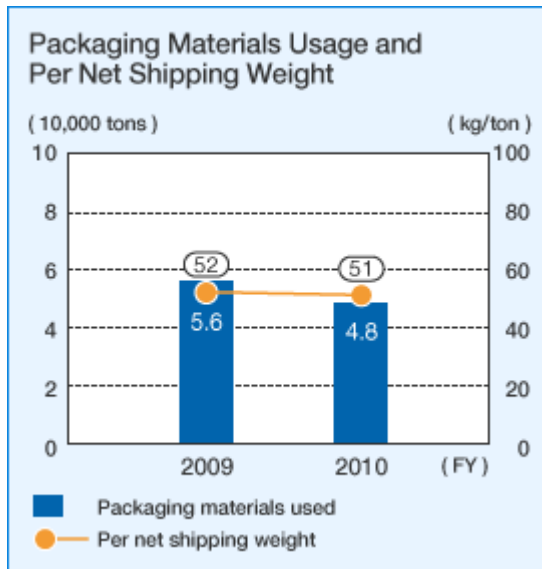

Fostering Environmental Awareness

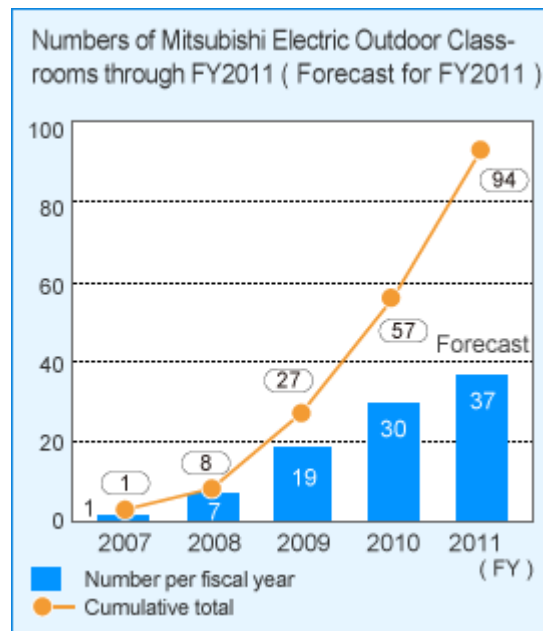
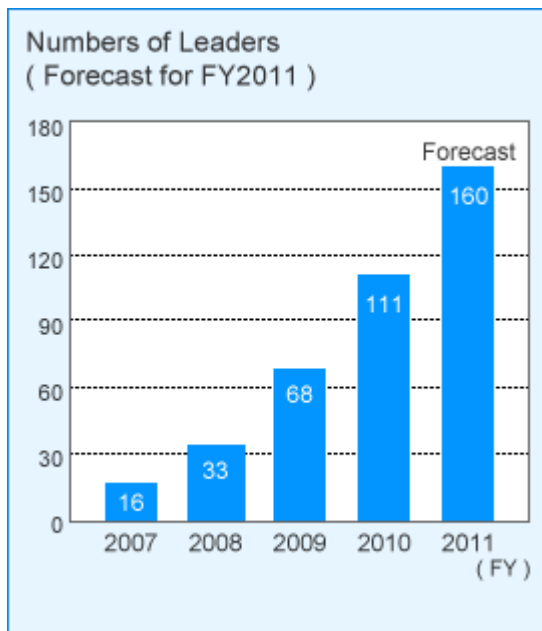

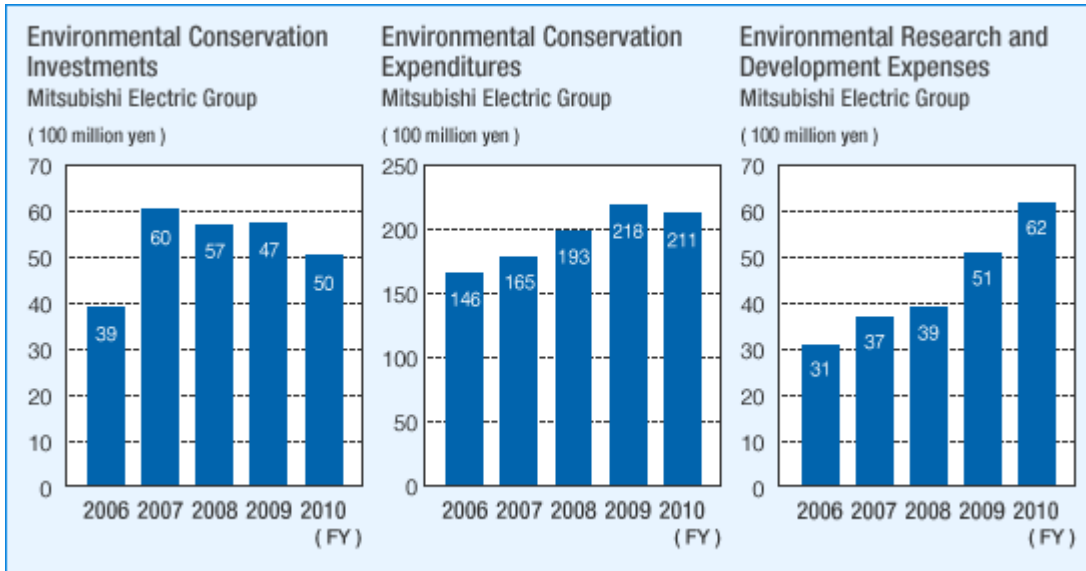

Respecting Biodiversity (Japan)

Mitsubishi Electric Outdoor Classroom Sessions

Mitsubishi Electric

Location	Date	Details / Theme	Participants	Office or site
Motegi Town, Tochigi	May 16, 2009	Rice planting, observing life forms in rice paddies and walking through native forest	40	Head Office
Motegi Town, Tochigi	September 26, 2009	Transplanting seedlings and observing life forms	40	Head Office
Kitanomaru Garden at the Imperial Palace	November 7, 2009	Accompanying a local kindergarten's field trip to experience nature in autumn	7	Head Office
Yokohama Nature Sanctuary	October 24, 2009	Participating in a nature walk guided by a ranger from the Wild Bird Society of Japan	26	Kanagawa Branch
Fujimae-Higata	March 22, 2010	Learning about the ecology of the tidelands with our guide from the Society for the Preservation of the Fujimae-Higata	8	Chubu Branch
Tanba City, Hyogo	June 20, September 19, November 17, 2009	Outdoor lessons in rice paddy fields	495 (3 sessions)	Kansai Branch
Flowerbeds of Heiwa Avenue, Hiroshima	May 30, 2009	Finding insects and bugs in flowerbeds and making dumplings from fresh herbs	18	Chugoku Branch
	November 28, 2009	Changing flowers for autumn	7	
Fukuoka Aburayama Nature Sanctuary	May 22, June 13, October 31, 2009	Forest exploration with a ranger from the Wild Bird Society of Japan	127 (3 sessions)	Kyushu Branch
Arima Fuji Shiitake Mushroom Park	July 25, 2009	Tree observation	23	Kobe Works
Aburai, Sasayama	October 24, 2009	Sweet potato and black soybean observation	22	
Mihama, Yanashi, Shiohigari	April 11, 2009	Gathering shells and observing sea life	161	Inazawa Works
Oppara Nature Center (Gifu)	May 23, 2009	Planting potato seedlings	38	
	August 9, 2009	Harvesting potatoes and blueberries	62	
Kasumigaura City, Ibaraki	October 31, 2009	Picking pears and participating in a nature tour	58	Kamakura Works
Oyamazaki Mountain Village Art Museum	October 31, 2009	Listening to an address by an Oyamazaki Hometown Center Volunteer (NPO) about the local area	23	Kyoto Works
Plaza near the Anzai bridge over the Abe River	November 7, 2009	Shizuoka region's first Mitsubishi Electric Outdoor Classroom: observing and	22	Shizuoka Works

		learning about the cycles of nature		
Tsutsuji Park, Nenoue Plateau	June 6, 2009	Observing nature with the five senses	28	Nakatsugawa Works
Nenoue Plateau, Nenoue Lake	September 5, 2009	Observing the diversity of flora while circling a lake	20	
Hoko Nature Center, Nenoue Plateau	November 14, 2009	Nature lecture (due to rain)	21	
Aichi (Mt. Tougokusan) Tougokusan Fruit Park conference room	April 4, August 29, 2009	Young families enjoying nature at Mt. Tougokusan: Nature observation and craft instruction	62 (2 sessions)	Nagoya Works *in conjunction with Aichi Moriyama Nature Association
Aichi public forest (Mt. Tougokusan)	March 27, 2010	Young families enjoying nature at Mt. Tougokusan: Nature observation and playground activities (swings and tightropes).	42	
Arima Fuji Park, Hyogo	October 31, 2009	Nature observation	33	Sanda Works
Nursery school	July 20, 2009	Cultivating and enjoying watermelon	25	Himeji Works
Aburayama Nature Sanctuary, Fukuyama	May 22, 2009	<u>Lessons on the secrets of nature</u> *in conjunction with the Kyushu Branch	67	Power Device Works
	October 24, 2009	Lessons on the secrets of nature	28	
Hinohara public forest, Tokyo	November 7, 2009	Cherishing plants	22	Sagami Administration Center
Katase Nishihama Beach	May 23, 2009	<u>Observing nature at the Eastern Research Institute Area Labor Union Dragnet Fest</u>	232	Information Technology R&D Center
Arima Fuji Prefectural Park	October 25, 2009	The wonders of nature in autumn / discovering the cycles of nature	30	Advanced Technology R&D Center
Kisarazu Beach	May 9, 2009	Gathering shells and catching sea creatures	50	In cooperation with head office and head office labor union

Affiliates in Japan

Location	Date	Details	Participants	Office or site
JR Oyamazaki - Oyamazaki Mountain Village Art Museum	October 31, 2009	Learning about the importance of trees	26	Mitsubishi Electric Engineering Co., Ltd.

Leadership Training Course Sessions

Location	Date	Details	Participants	Office or site
Ichijima Town, Tamba City, Hyogo	August 27-28, 2009	Acquiring Outdoor Classroom leadership skills and knowledge	21	Head office, Hokuriku Branch, Kansai Branch, Shikoku Branch, Kyushu Branch, Communication System Center, Inazawa Works, Kamakura Works, Nagoya Works, Sagami office, High Frequency & Optical Device Works, Nakatsugawa Works, Sanda Works, Fukuyama Works, Power Device Works Kumamoto Factory
Ichijima Town, Tamba City, Hyogo	September 4-5, 2009	Acquiring Outdoor Classroom leadership skills and knowledge	22	Head office, Tohoku Branch, Chubu Branch, Chugoku Branch, Kyushu Branch, Itami Works, Himeji Works, Communication Network Center, Communication System Center, Shizuoka Works, Kyoto Works, Nagoya Works, Power Device Works, Advanced Technology R&D Center

"Satoyama" Woodland Preservation Activities

Mitsubishi Electric

Location	Date	Details / Theme	Participants	Office or site
Aburai Sasayama	April 11, June 20, 2009	Maintenance of public forests in the Aburai region	2 (2 sessions)	Head Office
Mt. Fuji: Forest of Learning	August 1, 2009	Mt. Fuji forestry activity (cutting undergrowth)	2	
Mt. Fuji	April 11, August 1, 2009	Mt. Fuji afforestation - forestry volunteering (15 th , 16 th Sessions)	135 (Twice)	
Iwamoto, Nomi	August 30, 2009	Cutting undergrowth around cherry trees and oaks	160	Hokuriku Branch
Aburai Sasayama	April 11, June 20, November 21, December 9, 2009 January 23, March 6, 2010	Maintenance of public forests in the Aburai region	155 (6 sessions)	Kobe Works
Upstream plaza, Ugan Anzai bridge, Abe river	June 27, November 7, 2009	17 th & 18 th Abe River, Warashina River volunteer cleanup	160 (twice)	Shizuoka Works
Tsutsuji park, Nenoue plateau	June 6, September 5, 2009	Cutting undergrowth and pruning	88 (2 sessions)	Nakatsugawa Works
Kannabe Four Seasons Forest	December 3, 2009	Pruning / tree thinning	300	Fukuyama Works
Yurin, Aichi (Togokusan)	1-3 sessions per month	Members decided on the name "the Happy Foresters Troop", and a contract was signed between Nagoya Works and Aichi Prefecture to carry out woodland preservation activities such as cutting undergrowth, preserving rare species, pruning etc. *In cooperation with Aichi Moriyama Nature Society (Forest Instructor Enrollment)	Accumulated total 231	Nagoya Works

Affiliates in Japan

Location	Date	Details / Theme	Participants	Office or site
Regional Cleanup Activities	October 17, 2009	Cleaning up trash between the company offices and the top of Mt. Kanetsukidou	8	Mitsubishi Electric Home Appliance Co., Ltd.
Banks of the Abe River	November 7, 2009	Cleanup participation	1	Mitsubishi Electric Documentex Ltd.

Other Environmental Activities (Nature Preservation, Environmental Philanthropic Activities, Biodiversity Awareness Activities etc.)

Mitsubishi Electric

Location	Date	Details / Theme / Activities	Participants	Office or site
Tokyo Station vicinity	Every month	Sendai Environment Patrol	40	Head Office
Motegi Town, Tochigi Prefecture	May 17, 2009	Rice planting, looking for life forms in rice paddies and walking through native forest	57	
Park near Toyama Prefectural Office	June 20, 2009	Clean up of park by Toyama Prefectural Office	120	Hokuriku Branch
ANA Crown Plaza Hotel, Kanazawa	December 11, 2009	Head office invited a lecturer to speak to our members on businesses to counter global warming.	92	
Advanced Technology R&D Center	January 29, 2010	Environmental Technology Conference: Examples of Biodiversity Conservation (1st Session)	20	
Kohata Green Spaces, Nagoya	June 6, 2009	Clean Nagoya Campaign 2009	4	Chubu Branch
Around Sakae, Naka-ku, Nagoya	November 12, 2009	The "Let's Make a Safe and Livable Nagoya" Campaign 2009	2	
Advanced Technology R&D Center	November 19, 2009	Environmental management training for new employees	14	Kansai Branch
Hiroshima Heiwa Avenue Flowerbeds	May 30, 2009	Hiroshima Green Partner businesses Flowerbed maintenance Changing the flowers for spring	57	Chugoku Branch
	November 28, 2009	Hiroshima Green Partner businesses Flowerbed maintenance activities Changing the flowers for autumn	34	
Hiroshima Peace Park	July 28, 2009	Hiroshima Peace Park Concerted Clean-Up	32	
	December 5, 2009	Trees of Hiroshima Peace Park volunteer work	20	
	February 27, 2010	Hiroshima Peace Park Atomic Bomb Memorial cherry tree planting	31	
Takamatsu Central Avenue	Once a month	City organized Central Avenue cleanup	78	Shikoku Branch
Aibahama Park	Three times a year	Tokushima Prefecture 'Adopt Our Parks' Cleanup	17	
Takamatsu Central Park	June 21, 2009	City organized turf and tree planting in parks	6	
West Fukuoka Park	May 22, 2009	'Love the Earth' Cleanup 2009	121	Kyushu Branch
Kobe, Hyogo	May 25, September	Clean Streets Strategy	280 (3 times)	Electric Systems Works

	28, 2009, January 25, 2010			
Kanzaki Park	June 6, 2009	Kanzaki Park cleanup	100	Nagasaki Works
Togitsu 7 Ward	August 7, 2009	Togitsu 9th Ward cleanup	12	
Inasa International Cemetery	September 13, 2009	Inasa International Cemetery cleanup	300	
Togitsu, Nagasaki	October 4, November 8, 2009	Urban area cleanup	136	
Togitsu School for the Blind	November 7, 2009	Togitsu N Association School for the Blind cleanup	12	
Itami Works Main Building (5th Line)	July 24, 2009	Amagasaki Sprinkler Strateg	10	Itami Works
Amagasaki Eric	November 28, 2009	Exhibited at the Amagasaki 21st Century Forestry Forum	800	
City Home for the Mentally Challenged (Sakuraen)	August 10, 2009	Voluntary Clean-Up	25	Transmission & Distribution Systems Center
Neighborhoods surrounding the company offices (along the JR commuter rail line)	December 25, 2009	Cleaning up the commuter line between JR Tenna Station to Tomon Station	10	
Power Distribution Systems Center	March 31, 2010	1st Seminar on Environmental and Social Contribution	55	
Rice paddy fields south of Inazawa City Hall	May 31, 2009	Rice planting (art of Welcaru Inazawa- Plant and Reap)	51	Inazawa Works
Rice paddy fields south of Inazawa City Hall	October 25, 2009	Rice harvest (art of Welcaru Inazawa- Plant and Reap)	22	
Clean Campaign - in conjunction with the Craftsmen Association	June 17, 2009	Picking up trash near Inazawa power in conjunction with the Craftsmen Association and union members	200	
Clean Campaign	February 28, 2010	Picking up trash on Inazawa Main Street	80	
Second Hand Book Festival	July 24, 2009	Collecting used books in the city and distributing them free of charge. Proceeds donated to the Green Trust	-	Kamakura Works
National Highway by Koriyama Factory	May 15, July 18, 2009	Weeding Highway 4 sidewalk	150	Communication Network Center
Nunobiki Plateau, Koriyama	October 10, 2009	Walking classes under the wind generator	27	
Mihomasaki Coast	June 6, 2009	Mihomasaki Clean-Up Activity (supported by Shizuoka Environmental Conservation Cooperative)	1	Shizuoka Works
Tenryugawa (Iida)	June 7, 2009	16th Tenryu River System Environmental Picnic (Beatify	50	Nakatsugawa Works

		the Environment Campaign)		
Iida Art Museum	August 29, 2009	Supported the 2nd Science Craft Workshop for Children	6	
Kazakoshi High School, Iida	February 22, 2010	PV power generation classes (40 people per class)	-	
Heiwa Tokei (North Iida)	March 16, 2009	Assisted in the design of PV powered LED crime prevention lighting	2	
City Road South of Gunma Works	June 27, 2009	Volunteer tree pruning on the street by company offices	65	Gunma Works
Bizenjima Water Purification Tank, Ohta	July 4, 2009, March 6, 2010	Weeding the Bizenjima cherry tree plot	21 (twice)	
Kaneyama, Ohta	September 6, 2009	Cleaning up Kaneyama	33	
Ohta City Retirement Community	November 28, 2009	Mulching Branches at Ohta City Retirement Community	53	
Around Wakayama castle	November 8, 2009	The Wakayama Castle 10,000 Giant Clean-Up	22	
Around Yamaden	October 25, 2009	City wide cleanup in factory vicinity (Fukuyama Chamber of Commerce)	63	Fukuyama Works
Around Fukuyama JR Station	October 24, 2009	City Beautification Project (scraping gum from the footpaths)	25	
Sanda City Hall Vicinity	May 27, 2009	Picking up trash	70	Sanda Works
Picking-up trash around the commuter route	June 17, July 27, September 16, 2009	Picking up trash	75 (3 times)	
Commuter Route	May 10, 2009	Cleaning up the commuter route	140	Himeji Works
Nishihara	October 31, 2009	Cutting undergrowth in Blue, Clean, Green Forest (Kumamoto Environmental Conservation Cooperative)	18	Power Device Works Kumamoto Factory
Kumamoto Factory	May 27, 2009	River cleanup	160	
Sagami River	June 7, October 18, 2009	Sagami River Clean Strategy	Approx. 2,400 (twice)	Kamakura Works, Sagami factory
Vicinity of Ono Station, Sagami	November 7, 2009	Beatification Campaign	205	
Zugaike Park	May 30, October 3, 2009	Pruning and cleanup - maintaining cherry trees in Zugaike Park	61 (twice)	High Frequency & Optical Device Works

Affiliates in Japan

Location	Date	Details / Theme / Activities	Participants and attendees	Office or site
Kamakura	May 6, 31 September 23, 2009	Kamakura Cleanup 2009 (spring / autumn)	5 times	Information Systems Promotions Head Office
Sakura Park, Hyojo	June 4, 2009	Beatifying Sakura Park, Hyojo (local parks cleanup)	185	Toyo Electric Corporation
Kasai Industrial Park	Every Month	Green Campaign	16	SGC Company Ltd.
Okuda Pond cleanup	May 9, 2009	Okuda Reservoir Irrigation Union organized cleanup	12	Ryosan Industry Corporation
Nagao area cleanup	June 3, 2009	Cleaning up of the Nagao area, co-organized by Labor and Management	40	
Kansai Electric Okouchi Power Station	November 10, 2009	Hyogo Air Quality Preservation Cooperative Workshop	1	Ryoden Kasei Co., Ltd.
System Plaza, Arakawa, Tokyo	April, July, October 2009, January 2010	Installed planters at city and roadside flowerbeds	60	Mitsubishi Electric Building Techno-Service Co., Ltd.
Chubu Materials Center	Twice a week (Monday, Thursday)	Cleanup of the bus stop in front of the office	96	
West Fukuoka Park	May 30, 2009	Love the Earth Cleanup 2009	8	
Around Nagara River, Mino	October 25, 2009	Picking up trash on the riverside around Mino Bridge, Nagara River	24 staff	Mitsubishi Hitachi Home Elevator Corporation
Yatsugatake Neo-Oriental Resort Izumigo (Hokuto, Yamanashi) Marumasu Park (Matsuda, Kanagawa)	July 27-28, November 21, 2009	Living with Nature Summer Camp - mandarin picking	40	Mitsubishi Precision Co. Ltd.
Eniwa, Hokkaido	May 29, 2009	Technopark Spring Cleanup	26	Mitsubishi Electric TOKKI Systems Corporation
	May 30, 2009	Eniwa Clean Walking	2	
Kamakura, Kanagawa	May 31, 2009	Kamakura Spring Cleanup 2009 (town and mountains)	7	
	September 23, 2009	Kamakura Autumn Cleanup 2009 (seaside)	4	
	September 27, 2009	Kamakura Autumn Cleanup 2009 (town and mountains)	4	
Eniwa, Hokkaido	November 13, 2009	Technopark Autumn Cleanup	21	
Kamakura,	June 3,	Cleanup of commuter roads	195	

Kanagawa	2009- March 31, 2010			
Kamakura, Kanagawa	June 3, 2009- March 31, 2010	Cleanup of commuter roads	850	Mitsubishi Space Software Co., Ltd.
	July 2009	Donation to the Kanagawa Trust Green Fund	-	
	May 31, 2009	Cleanup Kamakura 2009	2	
Clean up of commuter roads	One person once a year	Clean Commuter Road	33	Ryoden Shonan Electronics Corporation
Kamakura, Kanagawa	May 31, September 27, 2009	Cleanup Kamakura - citywide clean-up	7	
-	Since October 2009	Eco-Cap Collection	-	Mitsubishi Electric Home Appliances Co., Ltd.
Kanizawa Drainage	July 15, 2009, March 29, 2010	Cleanup around Kanizawa drainage area	196 (Twice)	Mitsubishi Electric Home Appliance Co., Ltd.
Nakatsugawa	December 18, 2009	Nakatsugawa Car Free Day	60	Sowa Technica Inc.
Nakatsugawa	June, September 2009	Citywide cleanup	100	
Ichikawa	September 6, 2009	Ichikawa Environment Sun fest	-	Hyper Cycle Systems Co., Ltd.
	April 16, 2009	Local roadways cleanup	2	
Chiba	October 16-18, 2009	Exhibited at the 4th Nationwide Convention for the Promotion of the 3R's	-	
Funabashi Sanbanse Seaside Park	October 18, 2009	Funabashi Sanbanse Cleanup	9	Mitsubishi Electric Applied Refrigeration Systems Co., Ltd.
Amanuma Benten Pond, Funabashi	November 15, 2009	29th Clean Funabashi Day	10	
Eco-Police Cleanup	October 1, 2009	Industrial park cleanup (organized by the Eco-Police Cooperative)	25	Mitsubishi Electric Osram Ltd.
Nagata Coast	May 31, 2009	Love the Earth Cleanup 2009	12	Mitsubishi Electric FA Industrial Products Corporation
Factory and Imajuku Station vicinity	January 20, 2010	Cleanup around the factory and Imajuku Station	21	
Koudera factory vicinity	May 16, 2009	Cleanup of factory vicinity (organized by the Koudera Residents Association)	4	DB Seiko Co., Ltd.

Around Fukuzaki factory	May 29, 2009	Zero Trash Campaign (organized by the Fukuzaki Convention Center)	16	
Sagami Administration Center Planning & Administration Div. Semiconductor & Device Group	June 7, October 18, 2009	Sagami Clean Mission	32 (Twice)	Mitsubishi Electric Metecs Co., Ltd.
Kumamoto Region River Cleanup	March 28, 2009	River Cleanup	4	Sanshin Electronics Co., Ltd.
Koshi River Cleanup	July 25, 2009	2009 Kumamoto's 'Everyone's River and Sea Day'	5	
Nakatsugawa River System	April 29, 2009	Mitsubishi Electric Engineering Nature Exposition	97	Mitsubishi Electric Engineering Co., Ltd.
Kamakura	June 17, 2009	Commuter road cleanup	25	
	May 6, 2009	Kamakura Spring Cleanup 2009	9	
	September 23, 2009	Kamakura Autumn Cleanup 2009	9	
Along the Abe and Warashina rivers	June 27, 2009	River cleanup	2	
	November 7, 2009	River cleanup	2	
Kanzaki Gardens, Togistu	June 6, 2009	Kanzaki Garden cleanup (weeding)	15	
West Fukuoka Park	May 2009	Love the Earth Cleanup 2009	10	
Around Hokuriku Branch (agricultural waterway / roads)	October 15, 2009	Kosaka Association's irrigation water / roadside trash cleanup	70	Mitsubishi Electric System & Service Co., LTD
-	Once a month	Cleanup of mountain forest and riverbanks	1	Mitsubishi Electric Documentex Ltd.
-	June, October 2009, February 2010	Donated colored paper to a kindergarten	-	
Near the mouth of the Kikugawa River	July 25, 2009	Cleanup activity near the mouth of the Kikugawa River (organized by the Chamber of Commerce)	65	Melco Techno-Rex Co., Ltd.
Ohama Park	March 13, 2010	Ohama Park cleanup (organized by the Chamber of Commerce)	45	
Sapporo	July 1, October 21, 2009	Picking up trash in the parks	120 (twice)	KITA KOUDENSHA Corporation
Beautifying the Miyoshi High Tech apartment complex area	October 8, 2009	Apartment complex beautification	40 companies 86	Miyoshi Electronics Corp.

Ozeki Mountain Park	March 27, 2009	Ozeki Mountain Park volunteer cleanup (organized by the Mitsugi Administration & Regulation Committee)	207	
---------------------	-------------------	---	-----	--

**Supporting the Nature Preservation and Environmental Philanthropic Activities of
NGOs / NPOs (Personnel, Financial etc.)**

Mitsubishi Electric

NGO / NPO and activity	Date	Participants and attendees	Office or site
Cleanup activity on the Hirose River System with the Society to Protect and Clean the Hirose River NPO	June 13, July 11, December 12, 2009	17 (3 times)	Tohoku Branch
Saitama New City Center Green Strategy (picking up trash in neighborhoods of Saitama New City Center)	March 18, 2010	150	Kanetsu Branch
Planning the charity calendar for the Japan Volunteer Fire Relief Network NPO (donated four boxes of calendars and notebooks)	January 8, 2010	All divisions of Head Office	Kansai Branch
Collected clothes for the Foreign Relief Agency, shipped them to Japanese distribution center and raised funds for shipping fees	October 31, 2009	35	Inazawa Works
Cleanup of the Kamakura's sea, mountains, and city streets	May, October 2009	155	Kamakura Works
Love the Earth Cleanup 2009	May 31, 2009	302	Power Device Works

Affiliates in Japan

NGO / NPO and activity	Date	Participants	Office or site
Turning the night street lights out during the firefly mating period	June-July 2009	1	Sowa Technica Inc.
Volunteer with Ishikawa Forest Supporters NPO to cut undergrowth at Satoyama	July 10, 2009	170	Mitsubishi Electric System & Service Co., Ltd.

Respecting Biodiversity (Overseas)

Nature Preservation, Environmental Philanthropy and Biodiversity Awareness Activities

Location	Date	Topics / Themes	Participants	Office or site
Sunrise Lake Outdoor Education Center	April 24, 2009	Volunteer Day at Outdoor Education Center	24	Mitsubishi Electric Automation Inc.
Ang sila mangrove nature-education center, Chonburi.	August 14, 2009	Mother's day tree planting activities.	35	Mitsubishi Electric Thai Auto-Parts Co., Ltd.
Mangrove nature center, chonburi	May 5, 2009	Plant grow of forest project of Ministry of natural resources and environment.	20	
Lamcor, Sta Rosa City Laguna	April 23, 2009	Posting of Signages "Trees" by Joyce Kilmer	Approx. 50	Laguna Auto-Parts Manufacturing Corporation
Lamcor, Sta Rosa City Laguna	July 20, 2009	TREE Planting With the VIP (Masamitsu Okamura)	Approx. 10	
Lamcor, Sta Rosa City Laguna	October 8, 2009	TREE Planting With the VIP (Tsuyoshi Takahashi)	Approx. 10	
Lamcor, Sta Rosa City Laguna	February 12, 2010	TREE Planting With the VIP (Hajime Kako)	Approx. 10	
Lamcor, Sta Rosa City Laguna	February 26, 2009	TREE Planting With the VIP (Masanori Saitoh)	Approx. 10	
Changzhou	March 17, 2010	Environmental conservation (participated in cutting undergrowth from roadside trees)	4	Mitsubishi Electric Shihlin Automotive ChangZhou Co. Ltd.
Pittsburgh Sakura Project	April 2009	MEPPI participated in Sakura Project - planting of trees at local park.	Approx. 12	Mitsubishi Electric Power Products, Inc.
Xian Damingong Garden	March 2010	Tree-planting activities	675	XD Mitsubishi Electric Switchgear Co., Ltd
Adopt a Tree Campaign	September 9, 2009	To adopt one tree per employee and family	500	PIMS, S.A. de C.V.
SCI	-	Make leaf mold by ourself	20	Siam Compressor Industry Co., Ltd.

Supporting the Nature Preservation and the Environmental Philanthropy of NGOs / NPOs (Human Resources, Financial etc.)

Location	Date	Topics / Themes	Participants	Office or site
Oriental Land	February 6, 2010	Oriental Land cherry tree planting ceremony, organized by the Japan Sakura Association, Shizuoka Prefecture, and Shanghai-Japan Industry and Commerce Club. SAEC donated 300 trees and about 100 people attended. Donated 135 thousand yuan.	Approx 100	Shanghai Mitsubishi Electric & Shangling Air-Conditioner and Electric Appliance Co., Ltd.
Maysville Community	March 15, 2009	Tree giviaway (2000 trees)	10	Mitsubishi Electric Automotive America, Inc.
Sta Rosa City Laguna	April 22, 2009	Lakeshore Clean-up Drive	20	Laguna Auto-Parts Manufacturing Corporation
Sta Rosa City Laguna	October 19, 2009	Donation of Used Battery (incooperation with HCPI)	-	
Lamcor, Sta Rosa City Laguna	April 23, 2009	Distribution of stainless glass for Employees	Approx 450	

Non-Mitsubishi Electric Exhibitions and Events

Event	Date	Details / Products shown	Office or site
Eco-Products 2009	December 10-12, 2009	Theme: "Eco Changes - from in the home to outer space". Introduced Eco Changes initiatives for making use of progressive environmentally compatible technology in the home, office, factory or space.	Mitsubishi Electric Group
Exposition Aimed at the Chinese Communications Market	November 10-13, 2009	Exhibited a panel and demonstration products to improve our presence in the Chinese market.	Head Office
24th Power Supply Systems Expo	April 15-17, 2009	Exhibited different kinds of power devices, including advanced resistor and motor technologies, energy-saving machines, and new energy sources that can help improve environmental conservation.	Head Office, Power Device Works
Hokkaido FM live event lief Green Live	November 18, 2009	Gave a Powerpoint presentation introducing Mitsubishi Electric's environmental activities	Hokuriku Branch
Teikyo University Department of Science and Engineering's autumn open day	September 13, 2009	-	Kanetsu Branch
Yokohama Landmark Tower Conference on Climate Change Countermeasures	May 22, 2009	Mitsubishi Electric's environmental business and Kanagawa Branch's eco-office activities	Kanagawa Branch
Biwa Lake Environmental Business Message 2009	October 21-23, 2009	-	Kansai Branch
4th Tokei Business Fair 2009: Housing and Environment Expo	October 17-18, 2009	-	Kyushu Branch
Drainage Expo '09 Tokyo	July 28-31, 2009	Ozone generator, electronic multi-function plates	Kobe Works
Annual Conference and Exposition (ACE09)	June 14-17, 2009	Ozone generator	
Water Environment Federation Annual Technical Exhibition and Conference (WEFTEC 2009) *North America	October 12-14, 2009	Ozone generator (ozone bleaching demonstration)	
19th International Ozone Research Conference	August 31-September 3, 2009	Exhibited our catalog, published posters	
Hyogo Canal Festival PR Event (organized by Hyogo)	September 12, 2009	Environmental Vision 2021 and "Changing with Key Technologies" panel session	Nagasaki Works
Kansai Power Powerhouse 2009 and Energy Solutions Fair	June 10-12, 2009	Compact Cube	
Tokyo Power Energy Solutions	July 29-31,	Compact Cube Series	

Fair	2009		
Chubu Power "ENE-WAY2009"	August 26-28, 2009	Compact Cube Series	
ITU TELECOM WORLD 2009*Geneva, Switzerland	October 5-9, 2009	Resolia	
CEATEC JAPAN 2009	September 6-10, 2009	Organic EL, MEDIAWAY	
Biwa Lake Environmental Business Messe 2009	October 21-23, 2009	Compact Cube Series Model	
HVAC2010	February 16-19, 2010	Compact Cube Series	
Modern Railway 2009*Shanghai, China	June 22-25, 2009	Exhibited energy-saving CI device power unit and the IPM product it is based on. Distributed pamphlets about the CI device, the VVVF device, etc.	Itami Works
8th Amagasaki 'Creating Forests for the 22nd Century - Business and Kids Eco-Biz' Forum	November 29, 2009	Introduced eco-products and examples for environmental conservation (examples of solid waste recycling and rooftop gardens).	
High Speed Rail Seminar, Washington, US	January 21, 2009	Conducted a panel session on controller energy-saving devices and promoted energy-saving products and technologies.	
Environment Up 2009: business products and environment expo	October 3, 2009	Eco-monitor	Transmission & Distribution Systems Center
SECURITY SHOW 2010	March 9-12, 2010	Various eco-products	Inazawa Works, Communication Networks Center
Environmental Education at Neighborhood Elementary School	December 18, 2009	Educated Fujitsuka Elementary School 5 th graders about the environment, and discussed topics they could relate to like satellites, energy conservation, solid waste, and the cycles of life.	Kamakura Works
Nagaokakyo Environment Up	December 12, 2009	LCD televisions, simple photovoltaic systems, Mitsubishi Electric eco-products	Kyoto Works
Gifu Children's Science Expo	August 8-9, 2009	Photovoltaic Systems (home version)	Nakatsugawa Works
7 th Nakatsugawa Environment Up	October 10, 2009		
Chino, Nagano Environment up	October 18, 2009		
Nakatsugawa Sweets Fest	October 29-31, 2009		

Ena Environment Up	November 28, 2009		
Kansai Power Powerhouse 2009 Energy Solutions Fair	June 10-12, 2009	Proposed energy solutions through heat pumps and heat recovery systems.	Gunma Works
Energy Solutions Fair '09	July 29-31, 2009		
ENEX 2010 34 th Harmonizing the Global Environment and Energy Demands (forum on energy-saving home electronics).	February 10-12, 2010	All areas of energy-saving devices and products that utilize new energy sources.	
HVAC&R JAPAN 2010	February 16-19, 2010	Newest environmental products, with a focus on freezers and air conditioning equipment.	
20 th DMS Designs and Manufacturing Solutions Expo	June 24-26, 2009	-	Fukuyama Works
SCF Improving System Control 2009	November 25-28, 2009	-	
Himeji Environment Festival 2009	October 3-4, 2009	Examples of Mitsubishi Electric's environmental initiatives and environmentally effective products (ETC power steering), recycled products (alternator, starter).	Himeji Works

Mitsubishi Electric Exhibitions / Events

Event	Date	Activity	Office or site
Mitsubishi Electric Group Expo in Sendai	February 17-18, 2010	-	Tohoku Branch
All Mitsubishi Electric Group Expo in Kanagawa	February 3-4, 2010	Demonstration of photovoltaic systems, promotion of other environmental and energy-saving products, and organization of environment-related seminars.	Kanagawa Branch
Mitsubishi Electric Group Environmental Energy Saving product Expo 2009 in Chubu	October 20-21, 2009	-	Chubu Branch
Production Mechanic Private Show	November 19-21, 2009	-	Chubu Branch
Mitsubishi Electric Group Solutions eco / eco fair 2009	November 25-26, 2009	Exhibited 34 products, chiefly energy conservation, security and display equipment aimed at Hiroshima region users. Also held six seminars on environment and energy conservation.	Chugoku Branch
Seminar on actively implementing energy conservation measures	June 18, 2009	Demonstration of how to achieve real energy conservation in the factory, and a factory tour.	Shikoku Branch
The Complete Energy Saving Building Expo	June 30-July 1, 2009	-	Inazawa Works
Environment / Energy Conservation Private Forum	August 26, 2009	-	
Mitsubishi Electric Group Environmental Energy Conservation Expo 2009 in Chubu	October 20-21, 2009	-	
Complete Building Expo	June 30, 2009	-	Fukuyama Works
Mitsubishi Electric Group Environmental Energy Saving Conservation Expo 2009 in Chubu	October 20-21, 2010	Exhibition themed on "eco change throughout the entire company". Case study on energy conservation at factories that uses e-F@ctory, and a look at some of the transformative technologies it uses.	Nagoya Works

Awards

Japan

Award	Sponsor	Description / Product	Awardee
3rd Monozukuri Nippon Grand Award: Ministry of the Economy, Trade and Industry Award of Excellence	Ministry of Education, Culture, Sports, Science and Technology, Ministry of Health, Labour and Welfare, Ministry of Land, Infrastructure Transport and Tourism	Used fine laser processing technology to develop the world's highest efficiency polycrystalline silicon PV cell.	Mitsubishi Electric
Fiscal 2010 Energy Conservation Awards Minister of Economy, Trade and Industry	Energy Conservation Center, Japan	Home Air Conditioners "Kirigamine" ZW/ZXV series	Mitsubishi Electric
Good Design Award	Japan Industrial Design Promotion Organization	Airflow fan, Interior type	Mitsubishi Electric
Good Design Award	Japan Industrial Design Promotion Organization	Commercial Hanging Cassette Type Lossnay (Heat Energy Recovery Device)	Mitsubishi Electric
The Japan Good Packaging Award	Japan Packaging Institute	Simple packaging for the Jet-towel (hand drying device)	Mitsubishi Electric
39th Mechanical Engineering Award Japan	Industrial Design Promotion Organization Industry Newspaper	Wire electrical discharge machine NA series	Mitsubishi Electric
52nd 10 Big New Products Award	Nikkan Kogyo Shinbun	iQ_Platform Controller and Engineering Environment	Mitsubishi Electric
16th Semiconductor of the Year 2009 Grand Prix	Semiconductor Industry News	SiC Power Device Technology - 11 kW inverter cuts electricity losses by more than 70%	Mitsubishi Electric
Fellow Award	IEEE (the Institute of Electrical and Electronics Engineers US)	Award For contributions to compact and reliable high-voltage equipment Was esteemed for its use of high stress separation technology to advance product miniaturization and reduce SF6 gas.	Transmission & Distribution Systems Center
58th Electrical Manufacturers Awards Excellence Prize	Japan Electrical Manufacturers' Association	Room Air Conditioner - Energy Savings You Can See	Shizuoka Works

58th Electrical Manufacturers Awards Excellence Prize	Japan Electrical Manufacturers' Association	Development of Refrigerator Freezer that Freezes Even Hot Things in a Flash	Shizuoka Works
2010 Electrical Manufacturers Awards Excellence Prize	Japan Electrical Manufacturers' Association	Development of Ethernet Based Open Network CC-Link IE Controller Network	Nagoya Works
2010 Electrical Manufacturers Awards Excellence Prize	Japan Electrical Manufacturers' Association	Development of High Output Carbon Dioxide Laser Oscillator ML60CF-R	Nagoya Works
2010 Electrical Manufacturers Awards Excellence Prize	Japan Electrical Manufacturers' Association	Development of controller for die-sinking electrical discharge Machining GF2	Nagoya Works
Electronics Industry Technological Achievement Award - Best of Home Electronics	Japan Electrical Manufacturers' Association	Water Heating Tank with Micro Bubble Pipe Washing Feature	Advanced Technology R&D Center
2010 Japan Refrigeration and Air Conditioning Technology Award Technology Prize	Japan Society of Refrigerating and Air	Conditioning Engineers In a field where most things are completed only after years of research, the Compact Cube was in operation in less than a year. It is a truly remarkable piece of equipment - the best among such products	Mitsubishi Electric *awarded to both Kansai Power Inc. and Chubu Power Inc.
2010 Shikoku Region Invention Kagawa branch manager's Prize	Japan Institute of Invention and Innovation	Technology to determine the deterioration of insulators by the MT method and estimate remainder of product life	Power Distribution Systems Center Advanced Technology R&D Center
2010 Kanto Region Recognition in Innovation Kanto Bureau of Economy, Trade and Industry Chairman's Prize	Japan Institute of Invention and Innovation	Air Conditioner with Infrared Sensor	Shizuoka Works
2010 Kanto Region Recognition in Innovation Encouragement Award	Japan Institute of Invention and Innovation	Transmission Systems Using Compression Technology	Shizuoka Works
2010 Kanto Region Recognition in Innovation Encouragement Award	Japan Institute of Invention and Innovation	Power Monitoring Energy Conserving Controllers	Shizuoka Works
2010 National Recognition in Innovation 21st Century Encouragement in Innovation Award	Japan Institute of Invention and Innovation	Gradational Control Inverter	Mitsubishi Electric
2009 Electronics Employee Recognition for Innovation Planning and Achievement President of Shikoku Electronic Association	Japan Electric Association Shikoku Electronics Assoc.	Innovation in CBM technology using C-GIS Gas Isolation	Power Distribution Systems Center Advanced Technology R&D Center
41st Ichimura Industry Achievement Award	New Technology Development Group	High Speed Laser Drill Processor for Circuit Board	Mitsubishi Electric
1st Laser Society Industry	Laser Society	LASERVUE TV	Mitsubishi Electric

Award Encouraging Prize	Co.		
Sakura Merit Award	Japan Cherry Blossom Association	Awarded for planting cherry trees, supporting research, and all of their other commendable efforts to promote achievement	Frequency & Optical Device Works
Kumamoto Governor Prize	Kumamoto Gas Security Council	Specialist who exhibited outstanding handling of pressurized gas	Power Device Works Kumamoto Factory
Kumamoto Gas Security Council President Prize	Kumamoto Gas Security Council	Outstanding refrigeration safety specialist	Power Device Works Kumamoto Factory
Kumamoto Gas Security Council President Prize	Kumamoto Gas Security Council	Outstanding company (refrigeration)	Sanshin Electronics Co., Ltd.
2010 Hokkaido Promotion of Energy Savings and Alternative Energy Award for Alternative Energy	Hokkaido	Developing facilities and technology for alternative energy, they serve as an example of effective encouragement of alternative energy	KITA KOUDENSHA Corporation
2010 Shizuoka Governor Prize for Action to Prevent Climate Change	Shizuoka	Considerate to people and the Earth! The Shizuoka Works is the future home of EcoAmenity Environmental Management	Shizuoka Works
Excellence in Handling Hazardous Materials	Matsudo Hazardous Materials Safety Council	Recognized for outstanding vigilance in preventing hazardous material fires	Tokan Co., Ltd.
2010 Kanagawa Corporate Environmental Conservation Council Conservation Award	Kanagawa Corporate Environmental Conservation Council	Since they received Environmental Management Certification in 1999, they have worked together with Mitsubishi Electric regional Electronic Systems head office in Kamakura to reduce waste. They are recognized for their outstanding efforts to promote environmental conservation.	Ryoei Technica Corporation

Overseas

Award	Sponsor	Description / Product	Awardee
Microgeneration scheme	Uk Government / Micropower	Acheivement of accreditation to Microgeneration to allow ATW systems to obtain grant from government on installations	Mitsubishi Electric Air Conditioning Systems Europe Ltd.
Ecolable for Heat pumps	Ecolabel Accreditation Board	ATW system accreditations for best performance in industry	Mitsubishi Electric Air Conditioning Systems Europe Ltd.
Exemplary Autonomous Environmental Protection	Dalian Development Area, Bonded Area, Jinshitan National Holiday Resort	These groups carried out autonomous efforts to contribute to the environment such as energy conservation and reducing industrial waste. They are an example to other	Mitsubishi Electric Dalian Industrial Products Co., Ltd.

		companies of excellence in business. This was confirmed by Jinzhou New Area	
Appraisal of long-term results in improving the environmental performance of EMS	Cert Kladno	Environmental Management System	Mitsubishi Electric Automotive Czech s.r.o.
Certificate of Recognition	HONDA Cars Phil.	Corporate Social Responsibility	Laguna Auto-Parts Manufacturing Corporation