

Mitsubishi Electric AC Servo System

MITSUBISHI ELECTRIC SERVO SYSTEM
MELSERVO-J5

MR-J5 User's Manual (Troubleshooting)

-MR-J5- _G_
-MR-J5W _ _G_
-MR-J5D _ _G_
-MR-J5- _G_ - _N1
-MR-J5W _ _G_ - _N1
-MR-J5D _ _G_ - _N1
-MR-J5- _B_
-MR-J5W _ _B_
-MR-J5- _A_

SAFETY INSTRUCTIONS

Please read the instructions carefully before using the equipment.

To use the equipment correctly, do not attempt to install, operate, maintain, or inspect the equipment until you have read through this manual, installation guide, and appended documents carefully. Do not use the equipment until you have a full knowledge of the equipment, safety information and instructions.

In this manual, the safety instruction levels are classified into "WARNING" and "CAUTION".



WARNING

Indicates that incorrect handling may cause hazardous conditions, resulting in death or severe injury.



CAUTION

Indicates that incorrect handling may cause hazardous conditions, resulting in medium or slight injury.

Note that the CAUTION level may lead to a serious consequence depending on conditions.

Please follow the instructions of both levels because they are important to personnel safety.

Forbidden actions and required actions are indicated by the following diagrammatic symbols.



Indicates a forbidden action. For example, "No Fire" is indicated by .



Indicates a required action. For example, grounding is indicated by .

In this manual, precautions for hazards that can lead to property damage, instructions for other functions, and other information are shown separately in the "Point" area.

After reading this manual, keep it accessible to the operator.

[Installation/wiring]

WARNING

- To prevent an electric shock, turn off the power and wait for 15 minutes or more (20 minutes or more for the converter unit and drive unit) before starting wiring and/or inspection.
 - To prevent an electric shock, ground the servo amplifier.
 - To prevent an electric shock, any person who is involved in wiring should be fully competent to do the work.
 - To prevent an electric shock, mount the servo amplifier before wiring.
 - To prevent an electric shock, connect the protective earth (PE) terminal of the servo amplifier to the protective earth (PE) terminal of the cabinet, then connect the grounding lead wire to the ground.
 - To prevent an electric shock, do not touch the conductive parts.
-

[Setting/adjustment]

WARNING

- To prevent an electric shock, do not operate the switches with wet hands.
-

[Operation]

WARNING

- To prevent an electric shock, do not operate the switches with wet hands.
-

[Maintenance]

WARNING

- To prevent an electric shock, any person who is involved in inspection should be fully competent to do the work.
 - To prevent an electric shock, do not operate the switches with wet hands.
-

ABOUT THE MANUAL

Point

e-Manuals are Mitsubishi Electric FA electronic book manuals that can be browsed with a dedicated tool.

e-Manuals enable the following:

- Searching for desired information in multiple manuals at the same time (manual cross searching)
- Jumping from a link in a manual to another manual for reference
- Browsing for hardware specifications by scrolling over the components shown in product illustrations
- Bookmarking frequently referenced information
- Copying sample programs to engineering software

If using the servo for the first time, prepare and use the following related manuals to ensure that the servo is used safely. For the related manuals, refer to the User's Manual (Introduction).

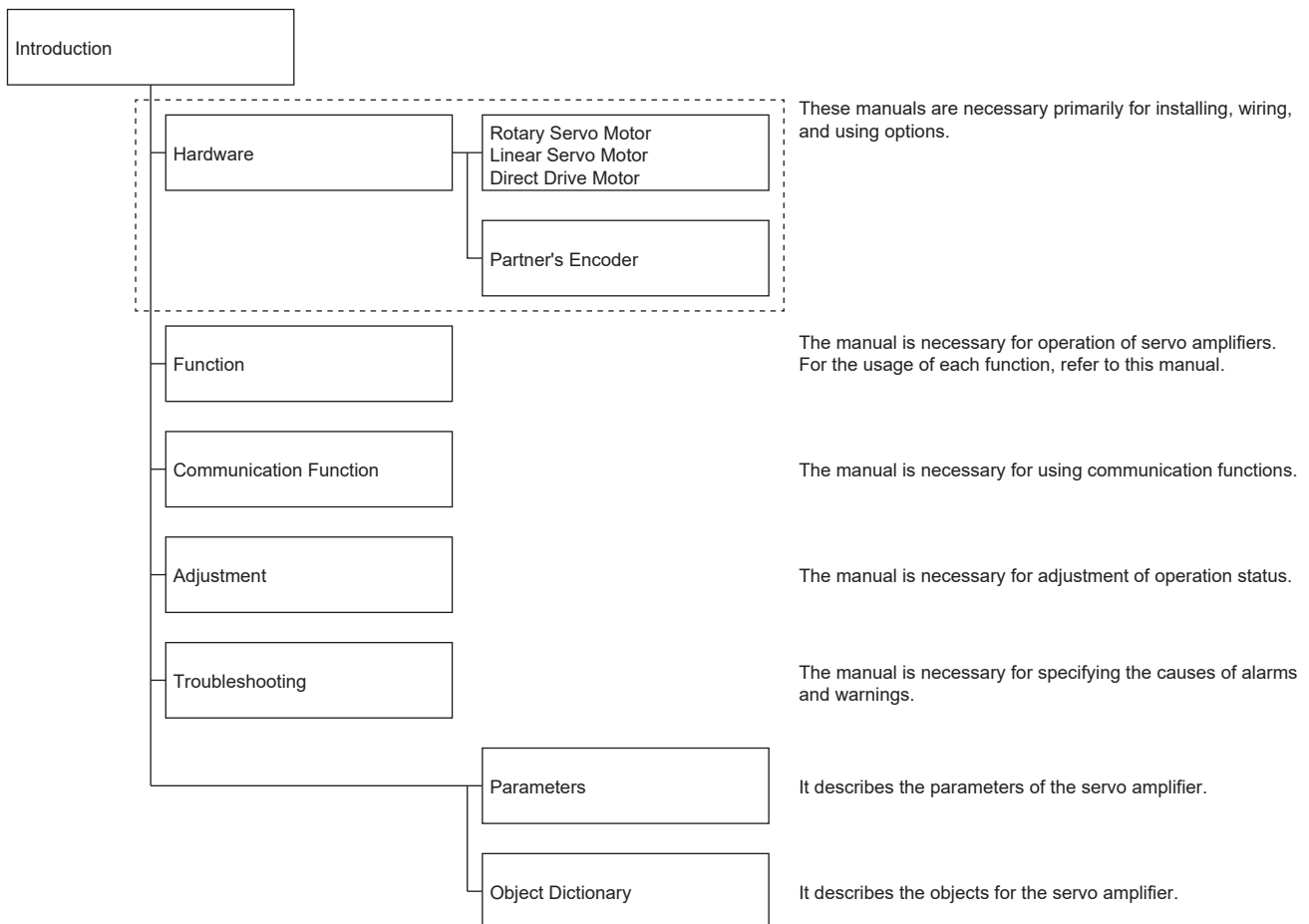

This manual covers the following servo amplifiers.

- MR-J5-G /MR-J5W--G /MR-J5D--G /MR-J5-B /MR-J5W--B /MR-J5-A

In this manual, the servo amplifier names are abbreviated as shown below.

Abbreviation	Servo amplifier
[G]	MR-J5- <u>G</u> /MR-J5W- <u>-G</u> /MR-J5D- <u>-G</u>
[B]	MR-J5- <u>B</u> /MR-J5W- <u>-B</u>
[A]	MR-J5- <u>A</u>

When reading this manual to use a drive unit, substitute "drive unit" for "servo amplifier".

Global standards and regulations

Compliance with the indicated global standards and regulations is current as of the release date of this manual. Some standards and regulations may have been modified or withdrawn.

U.S. CUSTOMARY UNITS

U.S. customary units are not shown in this manual. Convert the values if necessary according to the following table.

Quantity	SI (metric) unit	U.S. customary unit
Mass	1 [kg]	2.2046 [lb]
Length	1 [mm]	0.03937 [inch]
Torque	1 [N•m]	141.6 [oz•inch]
Moment of inertia	1 [$\times 10^{-4}$ kg•m ²]	5.4675 [oz•inch ²]
Load (thrust load/axial load)	1 [N]	0.2248 [lbf]
Temperature	N [$^{\circ}$ C] \times 9/5 + 32	N [$^{\circ}$ F]

CONTENTS

SAFETY INSTRUCTIONS	1
ABOUT THE MANUAL	3
U.S. CUSTOMARY UNITS	4
CHAPTER 1 SERVO AMPLIFIER TROUBLESHOOTING	10
1.1 Outline	10
1.2 List of alarm No./warning No.	12
Explanation of the list	12
List	14
1.3 Handling methods for alarms/warnings	32
[AL. 010_Undervoltage]	32
[AL. 011_Switch setting error]	34
[AL. 012_Memory error 1 (RAM)]	35
[AL. 013_CPU error]	36
[AL. 014_Control process error]	37
[AL. 016_Encoder initial communication error 1]	38
[AL. 017_Board error]	41
[AL. 019_Memory error 3]	43
[AL. 01A_Servo motor combination error]	44
[AL. 01B_Protection coordination error]	47
[AL. 01E_Encoder initial communication error 2]	48
[AL. 01F_Encoder initial communication error 3]	49
[AL. 020_Encoder normal communication error 1]	50
[AL. 021_Encoder normal communication error 2]	52
[AL. 024_Main circuit error]	54
[AL. 025_Absolute position erased]	55
[AL. 027_Initial magnetic pole detection error]	58
[AL. 028_Linear encoder error 2]	60
[AL. 02A_Linear encoder error 1]	61
[AL. 02B_Encoder counter error]	62
[AL. 030_Regenerative error]	63
[AL. 031_Overspeed]	65
[AL. 032_Overcurrent]	66
[AL. 033_Overvoltage]	68
[AL. 034_SSCNET receive error 1]	69
[AL. 035_Command frequency error]	70
[AL. 036_SSCNET receive error 2]	71
[AL. 037_Parameter error]	72
[AL. 03A_Inrush current suppression circuit error]	73
[AL. 03D_Driver communication parameter setting error]	74
[AL. 03E_Operation mode error]	74
[AL. 042_Servo control error]	75
[AL. 045_Main circuit device overheat]	78
[AL. 046_Servo motor overheat]	79
[AL. 047_Cooling fan error]	81
[AL. 050_Overload 1]	82
[AL. 051_Overload 2]	84
[AL. 052_Excessive error]	85

[AL. 054_Oscillation detection]	87
[AL. 056_Forced stop error]	88
[AL. 061_Operation error]	89
[AL. 063_STO timing error]	90
[AL. 066_Encoder initial communication error (safety sub-function)]	91
[AL. 067_Encoder normal communication error 1 (safety sub-function)]	92
[AL. 068_STO diagnosis error]	93
[AL. 069_Command error]	94
[AL. 070_Load-side encoder initial communication error 1]	96
[AL. 071_Load-side encoder normal communication error 1]	99
[AL. 072_Load-side encoder normal communication error 2]	101
[AL. 076_Load-side encoder error]	102
[AL. 082_Master-slave operation error 1]	103
[AL. 086_Network communication error]	104
[AL. 088_Watchdog 1]/[AL. 888_Watchdog 1]/[AL. 88888_Watchdog 1]	105
[AL. 08A_Serial communication time-out error]	106
[AL. 08E_Serial communication error]	107
[AL. 08F_Two-digit alarm No. display alarm]	108
[AL. 090_Homing incomplete warning]	110
[AL. 091_Servo amplifier overheat warning]	111
[AL. 092_Battery cable disconnection warning]	112
[AL. 093_ABS data transfer warning]	113
[AL. 095_STO warning]	114
[AL. 096_Home position setting warning]	115
[AL. 098_Software position limit warning]	116
[AL. 099_Stroke limit warning]	117
[AL. 09B_Excessive error warning]	119
[AL. 09C_Converter warning]	120
[AL. 09E_Network warning]	121
[AL. 09F_Battery warning]	123
[AL. 0E0_Excessive regeneration warning]	124
[AL. 0E1_Overload warning 1]	125
[AL. 0E2_Servo motor overheat warning]	127
[AL. 0E3_Absolute position counter warning]	128
[AL. 0E4_Parameter warning]	129
[AL. 0E5_ABS time-out warning]	130
[AL. 0E6_Servo forced stop warning]	131
[AL. 0E7_Controller forced stop warning]	132
[AL. 0E8_Deceased cooling fan speed warning]	133
[AL. 0E9_Main circuit off warning]	134
[AL. 0EA_ABS servo-on warning]	136
[AL. 0EB_The other axis error warning]	137
[AL. 0EC_Overload warning 2]	138
[AL. 0ED_Output watt excess warning]	139
[AL. 0EF_Reverse-side stop warning]	140
[AL. 0F0_Tough drive warning]	141
[AL. 0F2_Drive recorder warning]	142
[AL. 0F3_Oscillation detection warning]	143
[AL. 0F4_Positioning warning]	144
[AL. 0F7_Machine diagnosis warning]	145
[AL. 0FE_Two-digit warning No. display warning]	147

[AL. 118_Encoder diagnosis]	149
[AL. 119_Memory error 4]	150
[AL. 11A_Servo motor constant error]	152
[AL. 11B_Protection coordination connection error]	153
[AL. 130_Regenerative error 2]	154
[AL. 139_Open-phase error]	155
[AL. 13D_Driver communication network setting error]	156
[AL. 168_STO function error]	157
[AL. 16A_Master-slave operation simultaneous stop error]	158
[AL. 17A_Load-side linear encoder error 1]	159
[AL. 182_Driver communication error]	160
[AL. 186_Network communication error 2]	161
[AL. 188_Watchdog 2]	162
[AL. 19D_IP address setting change warning]	163
[AL. 19E_Network warning 2]	164
[AL. 1BD_Driver communication warning]	165
[AL. 1E9_Open-phase warning]	166
[AL. 1EA_Master-slave operation simultaneous stop warning]	167
[AL. 1EB_Manufacturer setting error]	168
[AL. 1F6_Manufacturer setting error]	169
[AL. 1F8_Memory warning 1]	170
[AL. 201 - 28F_Manufacturer setting error]	171
[AL. 290 - 2FF_Manufacturer setting warning]	172
[AL. 510_Voltage diagnosis error (safety sub-function)]	173
[AL. 512_Memory error 1 (RAM) (safety sub-function)]	174
[AL. 514_Control process error (safety sub-function)]	175
[AL. 515_Memory error 2 (ROM) (safety sub-function)]	176
[AL. 516_Encoder initial communication error 1 (safety sub-function)]	177
[AL. 517_Board error (safety sub-function)]	178
[AL. 518_Synchronous control error (safety sub-function)]	179
[AL. 519_Memory error 3 (Flash-ROM) (safety sub-function)]	180
[AL. 520_Encoder normal communication diagnosis error 1 (safety sub-function)]	181
[AL. 521_Encoder normal communication diagnosis error 2 (safety sub-function)]	182
[AL. 522_Encoder normal communication diagnosis error 3 (safety sub-function)]	183
[AL. 523_Encoder normal communication diagnosis error 4 (safety sub-function)]	184
[AL. 524_Encoder normal communication diagnosis error 5 (safety sub-function)]	185
[AL. 525_Encoder normal communication diagnosis error 6 (safety sub-function)]	186
[AL. 526_Encoder normal communication diagnosis error 7 (safety sub-function)]	187
[AL. 527_Encoder normal communication diagnosis error 8 (safety sub-function)]	188
[AL. 528_Encoder normal communication diagnosis error 9 (safety sub-function)]	189
[AL. 529_Encoder data error (safety sub-function)]	190
[AL. 52A_Position feedback error (safety sub-function)]	191
[AL. 52B_Encoder thermal error (safety sub-function)]	192
[AL. 537_Parameter setting range error (safety sub-function)]	193
[AL. 53A_Parameter verification error (safety sub-function)]	194
[AL. 540_Internal diagnosis error 1 (safety sub-function)]	195
[AL. 541_Internal diagnosis error 2 (safety sub-function)]	196
[AL. 542_Internal diagnosis error 3 (safety sub-function)]	197
[AL. 543_Internal diagnosis error 4 (safety sub-function)]	198
[AL. 544_Temperature diagnosis error (safety sub-function)]	199
[AL. 545_Internal diagnosis error 5 (safety sub-function)]	200

[AL. 546_ Internal diagnosis error 6 (safety sub-function)]	201
[AL. 547_ Internal diagnosis error 7 (safety sub-function)]	202
[AL. 549_ Internal diagnosis error 8 (safety sub-function)]	203
[AL. 54A_ Internal diagnosis error 9 (safety sub-function)]	204
[AL. 54D_ Internal diagnosis error 10 (safety sub-function)]	205
[AL. 54F_ Safety software error (safety sub-function)]	206
[AL. 550_ Internal diagnosis error 11 (safety sub-function)]	207
[AL. 551_ Internal diagnosis error 12 (safety sub-function)]	208
[AL. 552_ Internal diagnosis error 13 (safety sub-function)]	209
[AL. 553_ Input device diagnosis error (safety sub-function)]	210
[AL. 554_ Input device internal diagnosis error (safety sub-function)]	211
[AL. 555_ Output device diagnosis error 1 (safety sub-function)]	212
[AL. 556_ Output device diagnosis error 2 (safety sub-function)]	213
[AL. 557_ Input device mismatch detection (safety sub-function)]	214
[AL. 560_ Stop error (safety sub-function)]	216
[AL. 561_ Safety speed monitor error 1 (safety sub-function)]	218
[AL. 562_ Safety speed monitor error 2 (safety sub-function)]	220
[AL. 563_ Deceleration monitor error (safety sub-function)]	222
[AL. 564_ Increment monitor error (safety sub-function)]	224
[AL. 565_ Direction monitor error (safety sub-function)]	225
[AL. 568_ Torque monitor error 1 (safety sub-function)]	227
[AL. 569_ Torque monitor error 2 (safety sub-function)]	229
[AL. 580_ Safety communication setting error (safety sub-function)]	231
[AL. 581_ Safety communication error 1 (safety sub-function)]	232
[AL. 582_ Safety communication error 2 (safety sub-function)]	234
[AL. 583_ Safety communication error 3 (safety sub-function)]	235
[AL. 584_ FSoE communication setting error (safety sub-function)]	236
[AL. 585_ FSoE communication error 1 (safety sub-function)]	237
[AL. 586_ FSoE communication error 2 (safety sub-function)]	239
[AL. 587_ FSoE communication error 3 (safety sub-function)]	241
[AL. 595_ STO command off warning (safety sub-function)]	243
[AL. 596_ SS1 time-out warning (safety sub-function)]	244
[AL. 59D_ Internal diagnosis error (safety sub-function)]	245
[AL. 5E0_ Safety input device fixing diagnosis incomplete warning]	246
[AL. 5E1_ Test mode setting mismatch warning (safety sub-function)]	247
[AL. 5E2_ Safety communication warning (safety sub-function)]	248
[AL. 5E6_ SS1 command off warning (safety sub-function)]	249
1.4 Trouble which does not trigger an alarm/warning	250
The display shows "A" (unconnected to the controller)	250
The display shows "r###"	250
The display shows "b###"	251
The display shows "TST"	251
The display shows "off"	251
The display shows "SET"	251
The display shows "ECT" or "EIP"	251
The display is off	251
The servo motor does not operate	252
The increase in the servo motor speed is insufficient or excessive	254
Vibration of servo motor at low frequency	254
There is an unusual noise in the servo motor	255
The servo motor vibrates	255

Poor speed accuracy (Unstable speed of servo motor)	256
The machine vibrates unsteadily when it stops	256
Overshoot/undershoot occurs	256
The servo motor starts moving immediately after the power-on of the servo amplifier or servo-on	257
The home position deviates at the homing	257
The position deviates during operation after the homing	258
A position mismatch occurs at power restoration in an absolute position detection system	259
Communication with the servo amplifier fails using MR Configurator2	259
Electromagnetic brake went out	260
Electromagnetic brake cannot be released	260
The vertical axis falls when the SBC output is used	260
Coasting distance of the servo motor became longer	260
Executed point table does not work	261
RS-422 communication (Mitsubishi Electric AC servo protocol) cannot be used	261
1.5 Two-digit display of alarm/warning number	262
REVISIONS	264
WARRANTY	265
TRADEMARKS	266

1 SERVO AMPLIFIER TROUBLESHOOTING

Precautions

- In the MR-J5 series, the alarm No. and warning No. are shown with three digits, followed by one digit indicating the detail No. This has changed since the MR-J4 series, in which these numbers were shown with two digits and one digit, respectively.

1.1 Outline

If an error occurs in the servo system, the corresponding alarm or warning is displayed. When an alarm occurs, ALM (Malfunction) turns off.

If an alarm or warning is displayed, take appropriate measures according to the following:

☞ Page 32 Handling methods for alarms/warnings

Restrictions

- The following alarms are not recorded in the alarm history.
[AL. 010.1 Voltage drop in the control circuit power]
[AL. 037 Parameter error]
[AL. 537 Parameter setting range error (safety sub-function)]
[AL. 53A Parameter verification error (safety sub-function)]
- With the exception of [AL. 0F0 Tough drive warning], warnings are not recorded in the alarm history.
- Alarms marked with "△" in the "Alarm deactivation" column have the deactivation conditions shown in the following table.

Detail No.	Alarm deactivation condition
030.1	Approximately 30 minutes of cooling time have passed since the cause of the alarm occurrence was removed.
042.1	Set the servo parameters as follows.
042.2	When in fully closed loop control: Set [Pr. PE03.3 Fully closed loop control error - Reset selection] to "1".
042.3	When a linear servo motor or a direct drive motor is used: Set [Pr. PL04.3 [AL. 042 Servo control error] detection controller reset condition selection] to "1".
042.8	
042.9	
042.A	
046.1	Approximately 30 minutes of cooling time have passed since the cause of the alarm occurrence was removed.
046.2	
046.3	
046.4	
046.5	
046.6	
050.1	
050.2	
050.3	
050.4	
050.5	
050.6	
051.1	
051.2	
130.1	

Precautions

- As soon as an alarm occurs, switch to servo-off status and shut off the main circuit power supply.
- If an abnormality related to overheating occurs, remove the cause of the abnormality and allow a cooling time of approximately 30 minutes.
- The alarm canceling method in [AL. 042 Servo control error] can be changed with [Pr. PL04.3 [AL. 042 Servo control error] detection controller reset condition selection] or [Pr. PE03.3 Fully closed loop control error - Reset selection].
- If an alarm which is related to the communication with the controller occurs, resetting the communication may not cancel the alarm.
- In the alarm list, alarms marked with "o" in the "Safety reset" column must be canceled while all the safety sub-functions have stopped. These alarms cannot be canceled unless all the safety sub-functions have stopped.
- After performing the check/action, cycle the power of the servo amplifier.
- If the alarm remains active even after the check/action of each alarm, the servo amplifier may have malfunctioned. Replace the servo amplifier, then check the repeatability.
- If the same problem continues even after replacing the servo amplifier, there may be a problem with the surrounding environment or with other devices.
- When [AL. 025 Absolute position erased] occurs, perform homing again to prevent an unexpected operation.
- To prevent malfunctions of the servo amplifier and servo motor, do not deactivate the alarm repeatedly to resume if any of the following alarms occur. Remove the cause of occurrence and allow 30 minutes or more for cooling, then resume the operation.

[AL. 030 Regenerative error]

[AL. 045 Main circuit device overheat]

[AL. 046 Servo motor overheat]

[AL. 050 Overload 1]

[AL. 051 Overload 2]

- To prevent malfunctions of the servo amplifier and servo motor, do not cycle the power of the servo amplifier repeatedly to resume if any of the following warnings occur. If the power of the servo amplifier is switched off/on during the warnings, allow more than 30 minutes for cooling before resuming operation.

[AL. 091 Servo amplifier overheat warning]

[AL. 0E0 Excessive regeneration warning]

[AL. 0E1 Overload warning 1]

- When [AL. 0E6 Servo forced stop warning], [AL. 0E9 Main circuit off warning], [AL. 0EA ABS servo-on warning], or [AL. 0EB The other axis error warning] occurs, the servo amplifier is changed to servo-off status. If any other warning occurs, the operation can still be continued, but an alarm may occur.

1.2 List of alarm No./warning No.



Explanation of the list

Motor stop method

Alarms and warnings which have "SD" in the "Motor stop method" column stop the servo motor with the dynamic brake after forced stop deceleration. Alarms and warnings which have "DB" or "EDB" in the "Motor stop method" column stop the servo motor with the dynamic brake.

■ Stop method at occurrence of alarms/warnings

The servo amplifier has the following stop methods:

Motor stop method	Description
DB	Dynamic brake stop (for a servo amplifier without dynamic brake, the servo motor coasts)
SD	Forced stop deceleration This stop method is applicable when [Pr. PA04 Function selection A-1] is set to the initial value. The stop method can be changed from SD to DB with [Pr. PA04].
EDB	Stop with an electronic dynamic brake (enabled only for specific servo motors) Refer to "Stop method at occurrence of alarms/warnings" in the following manual for the specific servo motors.  MR-J5 User's Manual (Function)
STO/DB	Dynamic brake stop by the STO function (for a servo amplifier without dynamic brake, the servo motor coasts)
SS1/SD	Forced stop deceleration by the SS1 function The stop method is applicable when [Pr. PA04] is set to the initial value. The stop method can be changed from SS1/SD to SS1/DB with [Pr. PA04].
SS1/EDB	Stop with an electronic dynamic brake (enabled only for specific servo motors) Refer to "Stop method at occurrence of alarms/warnings" in the following manual for the specific servo motors.  MR-J5 User's Manual (Function) The stop method of SS1/DB is applicable to servo motors other than the said specific servo motors.

■ Specific stop methods

Quick stop or slow stop can be selected with [Pr. PD30 Function selection D-1] if the MR-J5- _A_ is used.

Converter main circuit stop target

If alarms and warnings have "○" in the "Converter main circuit stop target" column occur, the main circuit power supply of the converter unit connected with a protection coordination cable is shut off. During servo-on in the drive unit connected with a protection coordination cable, [AL. 01B Protection coordination error] occurs and the servo motor stops with the dynamic brake.

Alarm deactivation

Restriction

When using servo motors with functional safety, executing software reset may trigger [AL. 016 Encoder initial communication error 1]. If [AL. 016] occurs, cycle the power.

After the cause of the alarm has been removed, the alarm can be deactivated by using the methods marked with "○" in the "Alarm deactivation" column. Alarms marked with "△" in the "Alarm deactivation" column have the deactivation conditions.

 Page 10 Restrictions

Alarms are deactivated by alarm reset, communication reset, or power cycling. Alarms can also be deactivated by software reset instead of power cycling.

Refer to "Alarm function" in the following manual.

 MR-J5 User's Manual (Function)

Stop system

This stop system is applicable for the MR-J5W_, MR-J5D2_, and MR-J5D3_.

This indicates which axis to stop when an alarm or a warning occurs.

Each axis: Only the axis where the alarm or warning occurred will stop.

All axes: All axes will stop.

Motor stop warning

Warnings that have "○" in the "Motor stop warning" column stop the servo motor when the warning occurs. If a warning that stops the servo motor occurs, WNGSTOP (Motor stop warning) will turn on.

Safety sub-function stopped

Indicates that the safety sub-function stops when the alarm or warning occurs, disabling input to the safety sub-function and maintaining the shut-off state of the power supply. "SFTY" on the servo amplifier display turns off when the safety sub-function stops.

○: The safety sub-function stops and "SFTY" turns off.

×: The safety sub-function does not stop.

List

No.	Detail No.	Alarm/ Warning	Motor stop method	Stop system	Converter main circuit stop target	Alarm deactivation				Motor stop warning	Safety sub-function stopped
						Safety reset	Alarm reset	Communication reset	Power cycling		
010	010.1	Alarm	EDB	All axes	○	×	○	○	○	—	×
	010.2	Alarm	SD	All axes	○	×	○	○	○	—	×
011	011.1	Alarm	DB	All axes	○	×	×	×	○	—	×
	011.2	Alarm	DB	All axes	○	×	×	×	○	—	×
012	012.1	Alarm	DB	All axes	○	×	×	×	○	—	×
	012.2	Alarm	DB	All axes	○	×	×	×	○	—	×
	012.4	Alarm	DB	All axes	○	×	×	×	○	—	×
	012.5	Alarm	DB	All axes	○	×	×	×	○	—	×
	012.6	Alarm	DB	All axes	○	×	×	×	○	—	×
	012.7	Alarm	DB	All axes	○	×	×	×	○	—	×
	012.8	Alarm	DB	All axes	○	×	×	×	○	—	×
	012.9	Alarm	DB	All axes	○	×	×	×	○	—	×
013	013.1	Alarm	DB	All axes	○	×	×	×	○	—	×
	013.2	Alarm	DB	All axes	○	×	×	×	○	—	×
	013.4	Alarm	DB	All axes	○	×	×	×	○	—	×
	013.5	Alarm	DB	All axes	○	×	×	×	○	—	×
014	014.1	Alarm	DB	All axes	○	×	×	×	○	—	×
	014.2	Alarm	DB	All axes	○	×	×	×	○	—	×
	014.3	Alarm	DB	All axes	○	×	×	×	○	—	×
	014.4	Alarm	DB	All axes	○	×	×	×	○	—	×
	014.5	Alarm	DB	All axes	○	×	×	×	○	—	×
	014.8	Alarm	DB	All axes	○	×	×	×	○	—	×
	014.9	Alarm	DB	All axes	○	×	×	×	○	—	×
	014.C	Alarm	DB	All axes	○	×	×	×	○	—	×
016	016.1	Alarm	DB	Each axis	×	×	×	×	○	—	×
	016.2	Alarm	DB	Each axis	×	×	×	×	○	—	×
	016.3	Alarm	DB	Each axis	×	×	×	×	○	—	×
	016.5	Alarm	DB	Each axis	×	×	×	×	○	—	×
	016.6	Alarm	DB	Each axis	×	×	×	×	○	—	×
	016.7	Alarm	DB	Each axis	×	×	×	×	○	—	×
	016.A	Alarm	DB	Each axis	×	×	×	×	○	—	×
	016.B	Alarm	DB	Each axis	×	×	×	×	○	—	×
	016.C	Alarm	DB	Each axis	×	×	×	×	○	—	×
	016.D	Alarm	DB	Each axis	×	×	×	×	○	—	×
	016.E	Alarm	DB	Each axis	×	×	×	×	○	—	×
	016.F	Alarm	DB	Each axis	×	×	×	×	○	—	×
017	017.1	Alarm	DB	All axes	○	×	×	×	○	—	×
	017.3	Alarm	DB	All axes	○	×	×	×	○	—	×
	017.4	Alarm	DB	All axes	○	×	×	×	○	—	×
	017.5	Alarm	DB	All axes	○	×	×	×	○	—	×
	017.6	Alarm	DB	All axes	○	×	×	×	○	—	×
	017.7	Alarm	DB	All axes	○	×	×	×	○	—	×
	017.9	Alarm	DB	All axes	○	×	×	×	○	—	×
	017.A	Alarm	DB	All axes	○	×	×	×	○	—	×

No.	Detail No.	Alarm/Warning	Motor stop method	Stop system	Converter main circuit stop target	Alarm deactivation				Motor stop warning	Safety sub-function stopped
						Safety reset	Alarm reset	Communication reset	Power cycling		
019	019.1	Alarm	DB	All axes	○	×	×	×	○	—	×
	019.2	Alarm	DB	All axes	○	×	×	×	○	—	×
	019.3	Alarm	DB	All axes	○	×	×	×	○	—	×
	019.6	Alarm	DB	All axes	○	×	×	×	○	—	×
01A	01A.1	Alarm	DB	Each axis	×	×	×	×	○	—	×
	01A.2	Alarm	DB	Each axis	×	×	×	×	○	—	×
	01A.3	Alarm	DB	Each axis	×	×	×	×	○	—	×
	01A.4	Alarm	DB	Each axis	×	×	×	×	○	—	×
	01A.5	Alarm	DB	Each axis	×	×	×	×	○	—	×
	01A.6	Alarm	DB	Each axis	×	×	×	×	○	—	×
01B	01B.1	Alarm	DB	All axes	○	×	○	○	○	—	×
	01B.4	Alarm	DB	All axes	○	×	○	○	○	—	×
01E	01E.1	Alarm	DB	Each axis	×	×	×	×	○	—	×
	01E.2	Alarm	DB	Each axis	×	×	×	×	○	—	×
01F	01F.1	Alarm	DB	Each axis	×	×	×	×	○	—	×
	01F.2	Alarm	DB	Each axis	×	×	×	×	○	—	×
020	020.1	Alarm	EDB	Each axis	×	×	×	×	○	—	×
	020.2	Alarm	EDB	Each axis	×	×	×	×	○	—	×
	020.3	Alarm	EDB	Each axis	×	×	×	×	○	—	×
	020.5	Alarm	EDB	Each axis	×	×	×	×	○	—	×
	020.6	Alarm	EDB	Each axis	×	×	×	×	○	—	×
	020.7	Alarm	EDB	Each axis	×	×	×	×	○	—	×
	020.C	Alarm	EDB	Each axis	×	×	×	×	○	—	×
	020.D	Alarm	EDB	Each axis	×	×	×	×	○	—	×
021	021.1	Alarm	EDB	Each axis	×	×	×	×	○	—	×
	021.2	Alarm	EDB	Each axis	×	×	×	×	○	—	×
	021.3	Alarm	EDB	Each axis	×	×	×	×	○	—	×
	021.4	Alarm	EDB	Each axis	×	×	×	×	○	—	×
	021.5	Alarm	EDB	Each axis	×	×	×	×	○	—	×
	021.6	Alarm	EDB	Each axis	×	×	×	×	○	—	×
024	024.1	Alarm	DB	All axes	○	×	×	×	○	—	×
	024.2	Alarm	DB	All axes	○	×	○	○	○	—	×
025	025.1	Alarm	DB	Each axis	×	×	×	×	○	—	×
	025.2	Alarm	DB	Each axis	×	×	×	×	○	—	×
027	027.1	Alarm	DB	Each axis	×	×	○	○	○	—	×
	027.2	Alarm	DB	Each axis	×	×	○	○	○	—	×
	027.3	Alarm	DB	Each axis	×	×	○	○	○	—	×
	027.4	Alarm	DB	Each axis	×	×	○	○	○	—	×
	027.5	Alarm	DB	Each axis	×	×	○	○	○	—	×
	027.6	Alarm	DB	Each axis	×	×	○	○	○	—	×
	027.7	Alarm	DB	Each axis	×	×	○	○	○	—	×
028	028.1	Alarm	EDB	Each axis	×	×	×	×	○	—	×
	028.2	Alarm	EDB	Each axis	×	×	×	×	○	—	×

No.	Detail No.	Alarm/Warning	Motor stop method	Stop system	Converter main circuit stop target	Alarm deactivation				Motor stop warning	Safety sub-function stopped
						Safety reset	Alarm reset	Communication reset	Power cycling		
02A	02A.1	Alarm	EDB	Each axis	×	×	×	×	○	—	×
	02A.2	Alarm	EDB	Each axis	×	×	×	×	○	—	×
	02A.3	Alarm	EDB	Each axis	×	×	×	×	○	—	×
	02A.4	Alarm	EDB	Each axis	×	×	×	×	○	—	×
	02A.5	Alarm	EDB	Each axis	×	×	×	×	○	—	×
	02A.6	Alarm	EDB	Each axis	×	×	×	×	○	—	×
	02A.7	Alarm	EDB	Each axis	×	×	×	×	○	—	×
	02A.8	Alarm	EDB	Each axis	×	×	×	×	○	—	×
02B	02B.1	Alarm	EDB	Each axis	×	×	×	×	○	—	×
	02B.2	Alarm	EDB	Each axis	×	×	×	×	○	—	×
030	030.1	Alarm	DB	All axes	○	×	△	△	○	—	×
	030.2	Alarm	DB	All axes	○	×	×	×	○	—	×
	030.3	Alarm	DB	All axes	○	×	△	△	○	—	×
031	031.1	Alarm	SD	Each axis	×	×	○	○	○	—	×
032	032.1	Alarm	DB	All axes	○	×	×	×	○	—	×
	032.2	Alarm	DB	All axes	○	×	○	○	○	—	×
	032.3	Alarm	DB	All axes	○	×	×	×	○	—	×
	032.4	Alarm	DB	All axes	○	×	○	○	○	—	×
033	033.1	Alarm	EDB	All axes	○	×	○	○	○	—	×
034	034.1	Alarm	SD	All axes	○	×	○	○	○	—	×
	034.2	Alarm	SD	All axes	○	×	○	○	○	—	×
	034.3	Alarm	SD	Each axis	×	×	○	○	○	—	×
	034.4	Alarm	SD	All axes	○	×	○	○	○	—	×
	034.7	Alarm	SD	All axes	○	×	○	○	○	—	×
035	035.1	Alarm	SD	Each axis	×	×	○	○	○	—	×
036	036.1	Alarm	SD	Each axis	×	×	○	○	○	—	×
037	037.1	Alarm	DB	Each axis	○	×	×	○	○	—	×
	037.2	Alarm	DB	All axes	○	×	×	○	○	—	×
	037.3	Alarm	DB	Each axis	○	×	×	○	○	—	×
	037.6	Alarm	DB	Each axis	○	×	×	○	○	—	×
	037.7	Alarm	DB	Each axis	○	×	×	○	○	—	×
03A	03A.1	Alarm	EDB	All axes	○	×	×	×	○	—	×
03D	03D.1	Alarm	DB	Each axis	×	×	×	×	○	—	×
	03D.2	Alarm	DB	Each axis	×	×	×	×	○	—	×
03E	03E.4	Alarm	DB	Each axis	×	×	×	○	○	—	×
	03E.5	Alarm	DB	Each axis	×	×	×	○	○	—	×
	03E.9	Alarm	DB	Each axis	×	×	×	○	○	—	×
042	042.1	Alarm	EDB	Each axis	×	×	△	△	○	—	×
	042.2	Alarm	EDB	Each axis	×	×	△	△	○	—	×
	042.3	Alarm	EDB	Each axis	×	×	△	△	○	—	×
	042.8	Alarm	EDB	Each axis	×	×	△	△	○	—	×
	042.9	Alarm	EDB	Each axis	×	×	△	△	○	—	×
	042.A	Alarm	EDB	Each axis	×	×	△	△	○	—	×
045	045.1	Alarm	EDB	All axes	○	×	○	○	○	—	×
	045.2	Alarm	EDB	All axes	○	×	○	○	○	—	×

No.	Detail No.	Alarm/Warning	Motor stop method	Stop system	Converter main circuit stop target	Alarm deactivation				Motor stop warning	Safety sub-function stopped
						Safety reset	Alarm reset	Communication reset	Power cycling		
046	046.1	Alarm	SD	Each axis	×	×	△	△	○	—	×
	046.2	Alarm	SD	Each axis	×	×	△	△	○	—	×
	046.3	Alarm	SD	Each axis	×	×	△	△	○	—	×
	046.4	Alarm	SD	Each axis	×	×	△	△	○	—	×
	046.5	Alarm	DB	Each axis	×	×	△	△	○	—	×
	046.6	Alarm	DB	Each axis	×	×	△	△	○	—	×
	046.7	Alarm	DB	Each axis	×	×	△	△	○	—	×
047	047.1	Alarm	SD	All axes	○	×	×	×	○	—	×
	047.2	Alarm	SD	All axes	○	×	×	×	○	—	×
050	050.1	Alarm	SD	Each axis	×	×	△	△	○	—	×
	050.2	Alarm	SD	Each axis	×	×	△	△	○	—	×
	050.3	Alarm	SD	Each axis	×	×	△	△	○	—	×
	050.4	Alarm	SD	Each axis	×	×	△	△	○	—	×
	050.5	Alarm	SD	Each axis	×	×	△	△	○	—	×
	050.6	Alarm	SD	Each axis	×	×	△	△	○	—	×
051	051.1	Alarm	DB	Each axis	×	×	△	△	○	—	×
	051.2	Alarm	DB	Each axis	×	×	△	△	○	—	×
052	052.1	Alarm	SD	Each axis	×	×	○	○	○	—	×
	052.3	Alarm	SD	Each axis	×	×	○	○	○	—	×
	052.4	Alarm	SD	Each axis	×	×	○	○	○	—	×
	052.5	Alarm	EDB	Each axis	×	×	○	○	○	—	×
	052.6	Alarm	SD	Each axis	×	×	○	○	○	—	×
054	054.1	Alarm	EDB	Each axis	×	×	○	○	○	—	×
056	056.2	Alarm	EDB	Each axis	×	×	○	○	○	—	×
	056.3	Alarm	EDB	Each axis	×	×	○	○	○	—	×
	056.5	Alarm	EDB	Each axis	×	×	○	○	○	—	×
061	061.1	Alarm	DB	Each axis	×	×	○	○	○	—	×
063	063.1	Alarm	DB	Each axis	×	×	○	○	○	—	×
	063.2	Alarm	DB	Each axis	×	×	○	○	○	—	×
066	066.1	Alarm	DB	Each axis	×	×	×	×	○	—	×
	066.2	Alarm	DB	Each axis	×	×	×	×	○	—	×
	066.3	Alarm	DB	Each axis	×	×	×	×	○	—	×
	066.7	Alarm	DB	Each axis	×	×	×	×	○	—	×
	066.9	Alarm	DB	Each axis	×	×	×	×	○	—	×
067	067.1	Alarm	EDB	Each axis	×	×	×	×	○	—	×
	067.2	Alarm	EDB	Each axis	×	×	×	×	○	—	×
	067.3	Alarm	EDB	Each axis	×	×	×	×	○	—	×
	067.4	Alarm	EDB	Each axis	×	×	×	×	○	—	×
	067.7	Alarm	EDB	Each axis	×	×	×	×	○	—	×
068	068.1	Alarm	DB	All axes	○	×	×	×	○	—	×
069	069.1	Alarm	SD	Each axis	×	×	○	○	○	—	×
	069.2	Alarm	SD	Each axis	×	×	○	○	○	—	×
	069.3	Alarm	SD	Each axis	×	×	○	○	○	—	×
	069.4	Alarm	SD	Each axis	×	×	○	○	○	—	×
	069.5	Alarm	SD	Each axis	×	×	○	○	○	—	×
	069.6	Alarm	SD	Each axis	×	×	○	○	○	—	×

No.	Detail No.	Alarm/Warning	Motor stop method	Stop system	Converter main circuit stop target	Alarm deactivation				Motor stop warning	Safety sub-function stopped
						Safety reset	Alarm reset	Communication reset	Power cycling		
070	070.1	Alarm	DB	Each axis	×	×	×	×	○	—	×
	070.2	Alarm	DB	Each axis	×	×	×	×	○	—	×
	070.3	Alarm	DB	Each axis	×	×	×	×	○	—	×
	070.5	Alarm	DB	Each axis	×	×	×	×	○	—	×
	070.6	Alarm	DB	Each axis	×	×	×	×	○	—	×
	070.7	Alarm	DB	Each axis	×	×	×	×	○	—	×
	070.A	Alarm	DB	Each axis	×	×	×	×	○	—	×
	070.B	Alarm	DB	Each axis	×	×	×	×	○	—	×
	070.C	Alarm	DB	Each axis	×	×	×	×	○	—	×
	070.D	Alarm	DB	Each axis	×	×	×	×	○	—	×
	070.E	Alarm	DB	Each axis	×	×	×	×	○	—	×
	070.F	Alarm	DB	Each axis	×	×	×	×	○	—	×
071	071.1	Alarm	EDB	Each axis	×	×	×	×	○	—	×
	071.2	Alarm	EDB	Each axis	×	×	×	×	○	—	×
	071.3	Alarm	EDB	Each axis	×	×	×	×	○	—	×
	071.4	Alarm	EDB	Each axis	×	×	×	×	○	—	×
	071.5	Alarm	EDB	Each axis	×	×	×	×	○	—	×
	071.6	Alarm	EDB	Each axis	×	×	×	×	○	—	×
	071.7	Alarm	EDB	Each axis	×	×	×	×	○	—	×
	071.C	Alarm	EDB	Each axis	×	×	×	×	○	—	×
	071.D	Alarm	EDB	Each axis	×	×	×	×	○	—	×
072	072.1	Alarm	EDB	Each axis	×	×	×	×	○	—	×
	072.2	Alarm	EDB	Each axis	×	×	×	×	○	—	×
	072.3	Alarm	EDB	Each axis	×	×	×	×	○	—	×
	072.4	Alarm	EDB	Each axis	×	×	×	×	○	—	×
	072.5	Alarm	EDB	Each axis	×	×	×	×	○	—	×
	072.6	Alarm	EDB	Each axis	×	×	×	×	○	—	×
076	076.2	Alarm	DB	Each axis	×	×	×	×	○	—	×
	076.3	Alarm	DB	Each axis	×	×	×	×	○	—	×
082	082.1	Alarm	EDB	Each axis	×	×	○	○	○	—	×
086	086.1	Alarm	SD	All axes	○	×	○	×	○	—	×
	086.2	Alarm	SD	All axes	○	×	○	×	○	—	×
	086.3	Alarm	SD	All axes	○	×	○	×	○	—	×
	086.4	Alarm	SD	All axes	○	×	○	×	○	—	×
	086.5	Alarm	SD	All axes	○	×	○	×	○	—	×
	086.6	Alarm	SD	All axes	○	×	○	×	○	—	×
088/888/88888	088.1/ 088/888/ 88888	Alarm	DB	All axes	○	×	×	×	○	—	×
	088.2	Alarm	DB	All axes	○	×	×	×	○	—	×
	088.4	Alarm	DB	All axes	○	×	×	×	○	—	×
	088.8	Alarm	DB	All axes	○	×	×	×	○	—	×
08A	08A.1	Alarm	SD	All axes	○	×	○	○	○	—	×
08E	08E.1	Alarm	SD	All axes	○	×	○	○	○	—	×
	08E.2	Alarm	SD	All axes	○	×	○	○	○	—	×
	08E.3	Alarm	SD	All axes	○	×	○	○	○	—	×
	08E.4	Alarm	SD	All axes	○	×	○	○	○	—	×
	08E.5	Alarm	SD	All axes	○	×	○	○	○	—	×

No.	Detail No.	Alarm/Warning	Motor stop method	Stop system	Converter main circuit stop target	Alarm deactivation				Motor stop warning	Safety sub-function stopped
						Safety reset	Alarm reset	Communication reset	Power cycling		
08F	08F.1	Alarm	Refer to the alarm columns with alarm No. in 100s ([AL. 1_ _]).								
	08F.2	Alarm	Refer to the alarm columns with alarm No. in 200s ([AL. 2_ _]).								
	08F.3	Alarm	For manufacturer setting								
	08F.4	Alarm	For manufacturer setting								
	08F.5	Alarm	Refer to the alarm columns with alarm No. in 500s ([AL. 5_ _]).								
	08F.6	Alarm	For manufacturer setting								
	08F.7	Alarm	For manufacturer setting								
	08F.8	Alarm	For manufacturer setting								
	08F.9	Alarm	For manufacturer setting								
	08F.A	Alarm	For manufacturer setting								
	08F.B	Alarm	For manufacturer setting								
	08F.C	Alarm	For manufacturer setting								
	08F.D	Alarm	For manufacturer setting								
	08F.E	Alarm	For manufacturer setting								
	08F.F	Alarm	For manufacturer setting								
090	090.1	Warning	—	—	—	—	—	—	—	○	×
	090.2	Warning	—	—	—	—	—	—	—	○	×
	090.5	Warning	—	—	—	—	—	—	—	○	×
091	091.1	Warning	—	—	—	—	—	—	—	×	×
092	092.1	Warning	—	—	—	—	—	—	—	×	×
	092.2	Warning	—	—	—	—	—	—	—	×	×
	092.3	Warning	—	—	—	—	—	—	—	×	×
093	093.1	Warning	—	—	—	—	—	—	—	×	×
095	095.1	Warning	DB	Each axis	×	—	—	—	—	○	×
	095.2	Warning	DB	Each axis	×	—	—	—	—	○	×
096	096.1	Warning	— *1	—	—	—	—	—	—	○	×
	096.2	Warning	— *1	—	—	—	—	—	—	○	×
	096.3	Warning	— *1	—	—	—	—	—	—	○	×
	096.4	Warning	— *1	—	—	—	—	—	—	○	×
098	098.1	Warning	DB	Each axis	—	—	—	—	—	○	×
	098.2	Warning	DB	Each axis	—	—	—	—	—	○	×
099	099.1	Warning	— *2	—	—	—	—	—	—	○	×
	099.2	Warning	— *2	—	—	—	—	—	—	○	×
	099.4	Warning	— *2	—	—	—	—	—	—	○	×
	099.5	Warning	— *2	—	—	—	—	—	—	○	×
	099.6	Warning	— *2	—	—	—	—	—	—	○	×
	099.7	Warning	— *2	—	—	—	—	—	—	○	×
	099.8	Warning	— *2	—	—	—	—	—	—	○	×
	099.9	Warning	— *2	—	—	—	—	—	—	○	×
09B	09B.1	Warning	—	—	—	—	—	—	—	×	×
	09B.3	Warning	—	—	—	—	—	—	—	×	×
	09B.4	Warning	—	—	—	—	—	—	—	×	×
09C	09C.1	Warning	—	—	—	—	—	—	—	×	×

No.	Detail No.	Alarm/Warning	Motor stop method	Stop system	Converter main circuit stop target	Alarm deactivation				Motor stop warning	Safety sub-function stopped
						Safety reset	Alarm reset	Communication reset	Power cycling		
09E	09E.2	Warning	DB	All axes	○	—	—	—	—	○	×
	09E.3	Warning	DB	All axes	○	—	—	—	—	○	×
	09E.4	Warning	DB	All axes	○	—	—	—	—	○	×
	09E.5	Warning	DB	All axes	○	—	—	—	—	○	×
	09E.6	Warning	DB	All axes	○	—	—	—	—	○	×
	09E.7	Warning	DB	All axes	○	—	—	—	○	○	×
	09E.8	Warning	DB	All axes	○	—	—	—	○	○	×
	09E.9	Warning	DB	All axes	○	—	—	—	—	○	×
	09E.A	Warning	DB	All axes	○	—	—	—	—	○	×
	09E.B	Warning	DB	All axes	○	—	—	—	—	○	×
09F	09F.1	Warning	—	—	—	—	—	—	—	×	×
	09F.2	Warning	—	—	—	—	—	—	—	×	×
0E0	0E0.1	Warning	—	—	—	—	—	—	—	×	×
0E1	0E1.1	Warning	—	—	—	—	—	—	—	×	×
	0E1.2	Warning	—	—	—	—	—	—	—	×	×
	0E1.3	Warning	—	—	—	—	—	—	—	×	×
	0E1.4	Warning	—	—	—	—	—	—	—	×	×
	0E1.5	Warning	—	—	—	—	—	—	—	×	×
	0E1.6	Warning	—	—	—	—	—	—	—	×	×
	0E1.7	Warning	—	—	—	—	—	—	—	×	×
	0E1.8	Warning	—	—	—	—	—	—	—	×	×
0E2	0E2.1	Warning	—	—	—	—	—	—	—	×	×
	0E2.2	Warning	—	—	—	—	—	—	—	×	×
0E3	0E3.1	Warning	—	—	—	—	—	—	—	×	×
	0E3.2	Warning	—	—	—	—	—	—	—	×	×
	0E3.5	Warning	—	—	—	—	—	—	—	×	×
	0E3.6	Warning	—	—	—	—	—	—	—	×	×
0E4	0E4.1	Warning	—	—	—	—	—	—	—	×	×
0E5	0E5.1	Warning	—	—	—	—	—	—	—	×	×
	0E5.2	Warning	—	—	—	—	—	—	—	×	×
	0E5.3	Warning	—	—	—	—	—	—	—	×	×
0E6	0E6.1	Warning	SD	All axes	○	—	—	—	—	○	×
0E7	0E7.1	Warning	SD	All axes	○	—	—	—	—	○	×
0E8	0E8.1	Warning	—	—	—	—	—	—	—	×	×
	0E8.2	Warning	—	—	—	—	—	—	—	×	×
0E9	0E9.1	Warning	DB	All axes	○	—	—	—	—	○	×
	0E9.2	Warning	DB	All axes	○	—	—	—	—	○	×
	0E9.3	Warning	DB	All axes	○	—	—	—	—	○	×
	0E9.4	Warning	DB	All axes	○	—	—	—	—	○	×
0EA	0EA.1	Warning	—	—	×	—	—	—	—	×	×
0EB	0EB.1	Warning	DB	Each axis	×	—	—	—	—	○	×
0EC	0EC.1	Warning	—	—	—	—	—	—	—	×	×
0ED	0ED.1	Warning	—	—	—	—	—	—	—	×	×
0EF	0EF.1	Warning	—	—	—	—	—	—	—	×	×
0F0	0F0.1	Warning	—	—	—	—	—	—	—	×	×
	0F0.3	Warning	—	—	—	—	—	—	—	×	×

No.	Detail No.	Alarm/Warning	Motor stop method	Stop system	Converter main circuit stop target	Alarm deactivation				Motor stop warning	Safety sub-function stopped
						Safety reset	Alarm reset	Communication reset	Power cycling		
0F2	0F2.1	Warning	—	—	—	—	—	—	○	×	×
	0F2.2	Warning	—	—	—	—	—	—	○	×	×
	0F2.3	Warning	—	—	—	—	—	—	○	×	×
	0F2.4	Warning	—	—	—	—	—	—	○	×	×
	0F2.5	Warning	—	—	—	—	—	—	○	×	×
	0F2.6	Warning	—	—	—	—	—	—	○	×	×
0F3	0F3.1	Warning	—	—	—	—	—	—	—	×	×
0F4	0F4.4	Warning	—	—	—	—	—	—	—	○	×
	0F4.6	Warning	—	—	—	—	—	—	—	○	×
	0F4.7	Warning	—	—	—	—	—	—	—	○	×
	0F4.8	Warning	—	—	—	—	—	—	—	○	×
	0F4.A	Warning	—	—	—	—	—	—	—	○	×
0F7	0F7.1	Warning	—	—	—	—	—	—	—	×	×
	0F7.2	Warning	—	—	—	—	—	—	—	×	×
	0F7.3	Warning	—	—	—	—	—	—	—	×	×
	0F7.4	Warning	—	—	—	—	—	—	—	×	×
	0F7.5	Warning	—	—	—	—	—	—	—	×	×
	0F7.6	Warning	—	—	—	—	—	—	—	×	×
0FE	0FE.1	Warning	Refer to the warning columns with warning No. in 100s ([AL. 1_ _]).								
	0FE.2	Warning	Refer to the warning columns with warning No. in 200s ([AL. 2_ _]).								
	0FE.3	Warning	For manufacturer setting								
	0FE.4	Warning	For manufacturer setting								
	0FE.5	Warning	Refer to the warning columns with warning No. in 500s ([AL. 5_ _]).								
	0FE.6	Warning	For manufacturer setting								
	0FE.7	Warning	For manufacturer setting								
	0FE.8	Warning	For manufacturer setting								
	0FE.9	Warning	For manufacturer setting								
	0FE.A	Warning	For manufacturer setting								
	0FE.B	Warning	For manufacturer setting								
	0FE.C	Warning	For manufacturer setting								
	0FE.D	Warning	For manufacturer setting								
	0FE.E	Warning	For manufacturer setting								
0FE.F	Warning	For manufacturer setting									
118	118.1	Alarm	DB	All axes	○	×	×	×	○	—	×
119	119.1	Alarm	DB	All axes	○	×	×	×	○	—	×
	119.2	Alarm	DB	All axes	○	×	×	×	○	—	×
	119.3	Alarm	DB	All axes	○	×	×	×	○	—	×
	119.4	Alarm	DB	All axes	○	×	×	×	○	—	×
	119.5	Alarm	DB	All axes	○	×	×	×	○	—	×
	119.6	Alarm	DB	All axes	○	×	×	×	○	—	×
	119.7	Alarm	DB	All axes	○	×	×	×	○	—	×
	119.8	Alarm	DB	All axes	○	×	×	×	○	—	×
11A	11A.1	Alarm	DB	Each axis	×	×	×	×	○	—	×
	11A.2	Alarm	DB	Each axis	×	×	×	×	○	—	×
	11A.3	Alarm	DB	Each axis	×	×	×	×	○	—	×
11B	11B.1	Alarm	DB	All axes	○	×	○	○	○	—	×
130	130.1	Alarm	DB	All axes	○	×	○	○	○	×	×

No.	Detail No.	Alarm/Warning	Motor stop method	Stop system	Converter main circuit stop target	Alarm deactivation				Motor stop warning	Safety sub-function stopped
						Safety reset	Alarm reset	Communication reset	Power cycling		
139	139.1	Alarm	DB	All axes	×	×	×	×	○	—	×
	139.2	Alarm	DB	Each axis	×	×	×	×	○	—	×
	139.3	Alarm	DB	Each axis	×	×	×	×	○	—	×
	139.4	Alarm	DB	Each axis	×	×	×	×	○	—	×
13D	13D.1	Alarm	DB	All axes	×	×	○	○	○	—	×
	13D.2	Alarm	DB	All axes	×	×	○	○	○	—	×
	13D.3	Alarm	DB	All axes	×	×	○	○	○	—	×
168	168.1	Alarm	DB	All axes	×	×	○	○	○	—	×
16A	16A.1	Alarm	DB	Each axis	×	×	○	○	○	—	×
	16A.2	Alarm	DB	Each axis	×	×	○	○	○	—	×
17A	17A.1	Alarm	EDB	Each axis	×	×	×	×	○	—	×
	17A.2	Alarm	EDB	Each axis	×	×	×	×	○	—	×
	17A.3	Alarm	EDB	Each axis	×	×	×	×	○	—	×
	17A.4	Alarm	EDB	Each axis	×	×	×	×	○	—	×
	17A.5	Alarm	EDB	Each axis	×	×	×	×	○	—	×
	17A.6	Alarm	EDB	Each axis	×	×	×	×	○	—	×
	17A.7	Alarm	EDB	Each axis	×	×	×	×	○	—	×
	17A.8	Alarm	EDB	Each axis	×	×	×	×	○	—	×
182	182.1	Alarm	DB	Each axis	×	×	○	○	○	—	×
	182.2	Alarm	DB	Each axis	×	×	○	○	○	—	×
186	186.1	Alarm	DB	All axes	○	×	×	×	○	—	×
	186.2	Alarm	DB	All axes	○	×	×	×	○	—	×
	186.3	Alarm	DB	All axes	○	×	×	×	○	—	×
	186.4	Alarm	DB	All axes	○	×	×	×	○	—	×
	186.5	Alarm	DB	All axes	○	×	×	×	○	—	×
	186.6	Alarm	DB	All axes	○	×	×	×	○	—	×
188	188.1	Alarm	DB	All axes	○	×	×	×	○	—	×
19D	19D.1	Warning	—	—	—	—	—	—	—	×	×
	19D.2	Warning	—	—	—	—	—	—	—	×	×
19E	19E.1	Warning	—	—	—	—	—	—	—	—	×
	19E.2	Warning	—	—	—	—	—	—	—	—	×
	19E.3	Warning	—	—	—	—	—	—	—	—	×
	19E.4	Warning	—	—	—	—	—	—	—	—	×
	19E.5	Warning	—	Each axis	—	—	—	—	—	×	×
	19E.6	Warning	—	Each axis	—	—	—	—	—	×	×
1BD	1BD.1	Warning	DB	All axes	×	—	—	—	—	○	×
	1BD.2	Warning	DB	All axes	×	—	—	—	—	○	×
	1BD.3	Warning	DB	All axes	×	—	—	—	—	○	×
	1BD.4	Warning	DB	All axes	×	—	—	—	—	○	×
1E9	1E9.1	Warning	—	—	—	—	—	—	—	×	×
1EA	1EA.1	Warning	—	Each axis	—	—	—	—	—	—	×
	1EA.2	Warning	—	Each axis	—	—	—	—	—	—	×
1EB	1EB.1	Warning	—	Each axis	—	—	—	—	—	×	×
	1EB.2	Warning	—	Each axis	—	—	—	—	—	×	×
	1EB.3	Warning	—	Each axis	—	—	—	—	—	×	×

No.	Detail No.	Alarm/Warning	Motor stop method	Stop system	Converter main circuit stop target	Alarm deactivation				Motor stop warning	Safety sub-function stopped
						Safety reset	Alarm reset	Communication reset	Power cycling		
1F6	1F6.1	Warning	—	Each axis	—	—	—	—	—	×	×
	1F6.2	Warning	—	Each axis	—	—	—	—	—	×	×
	1F6.3	Warning	—	Each axis	—	—	—	—	—	×	×
	1F6.4	Warning	—	Each axis	—	—	—	—	—	×	×
	1F6.5	Warning	—	Each axis	—	—	—	—	—	×	×
	1F6.6	Warning	—	Each axis	—	—	—	—	—	×	×
1F8	1F8.1	Warning	—	—	—	—	—	—	—	×	×
	1F8.2	Warning	—	—	—	—	—	—	—	×	×
201 - 28F	—	Alarm	For manufacturer setting								
290 - 2FF	—	Warning	For manufacturer setting								
510	510.1	Alarm	STO/DB	All axes	○	○	×	×	○	—	○
	510.2	Alarm	STO/DB	All axes	○	○	×	×	○	—	○
	510.7	Alarm	STO/DB	All axes	○	○	×	×	○	—	○
	510.9	Alarm	STO/DB	All axes	○	○	×	×	○	—	○
	510.A	Alarm	STO/DB	All axes	○	○	×	×	○	—	○
	510.B	Alarm	STO/DB	All axes	○	○	×	×	○	—	○
	510.C	Alarm	STO/DB	All axes	○	○	×	×	○	—	○
	510.D	Alarm	STO/DB	All axes	○	○	×	×	○	—	○
	510.E	Alarm	STO/DB	All axes	○	○	×	×	○	—	○
	510.F	Alarm	STO/DB	All axes	○	○	×	×	○	—	○
512	512.2	Alarm	STO/DB	All axes	○	×	×	×	○	—	○
	512.3	Alarm	STO/DB	All axes	○	×	×	×	○	—	○
	512.A	Alarm	STO/DB	All axes	○	×	×	×	○	—	○
	512.B	Alarm	STO/DB	All axes	○	×	×	×	○	—	○
514	514.9	Alarm	STO/DB	All axes	○	×	×	×	○	—	○
	514.A	Alarm	STO/DB	All axes	○	×	×	×	○	—	○
515	515.9	Alarm	STO/DB	All axes	○	×	×	×	○	—	○
	515.A	Alarm	STO/DB	All axes	○	×	×	×	○	—	○
516	516.1	Alarm	STO/DB	Each axis	×	×	×	×	○	—	○
	516.2	Alarm	STO/DB	Each axis	×	×	×	×	○	—	○
	516.3	Alarm	STO/DB	Each axis	×	×	×	×	○	—	○
	516.4	Alarm	STO/DB	Each axis	×	×	×	×	○	—	○
	516.5	Alarm	STO/DB	Each axis	×	×	×	×	○	—	○
	516.9	Alarm	STO/DB	Each axis	×	×	×	×	○	—	○
	516.A	Alarm	STO/DB	Each axis	×	×	×	×	○	—	○
	516.B	Alarm	STO/DB	Each axis	×	×	×	×	○	—	○
	516.C	Alarm	STO/DB	Each axis	×	×	×	×	○	—	○
	516.D	Alarm	STO/DB	Each axis	×	×	×	×	○	—	○
517	517.2	Alarm	STO/DB	All axes	○	×	×	×	○	—	○
	517.9	Alarm	STO/DB	All axes	○	×	×	×	○	—	○
518	518.2	Alarm	STO/DB	All axes	○	×	×	×	○	—	○
	518.A	Alarm	STO/DB	All axes	○	×	×	×	○	—	○
519	519.2	Alarm	STO/DB	All axes	○	×	×	×	○	—	○
	519.A	Alarm	STO/DB	All axes	○	×	×	×	○	—	○

No.	Detail No.	Alarm/Warning	Motor stop method	Stop system	Converter main circuit stop target	Alarm deactivation				Motor stop warning	Safety sub-function stopped
						Safety reset	Alarm reset	Communication reset	Power cycling		
520	520.1	Alarm	STO/DB	Each axis	×	×	×	×	○	—	○
	520.2	Alarm	STO/DB	Each axis	×	×	×	×	○	—	○
	520.3	Alarm	STO/DB	Each axis	×	×	×	×	○	—	○
	520.4	Alarm	STO/DB	Each axis	×	×	×	×	○	—	○
	520.9	Alarm	STO/DB	Each axis	×	×	×	×	○	—	○
	520.A	Alarm	STO/DB	Each axis	×	×	×	×	○	—	○
	520.B	Alarm	STO/DB	Each axis	×	×	×	×	○	—	○
	520.C	Alarm	STO/DB	Each axis	×	×	×	×	○	—	○
521	521.1	Alarm	STO/DB	Each axis	×	×	×	×	○	—	○
	521.2	Alarm	STO/DB	Each axis	×	×	×	×	○	—	○
	521.3	Alarm	STO/DB	Each axis	×	×	×	×	○	—	○
	521.9	Alarm	STO/DB	Each axis	×	×	×	×	○	—	○
	521.A	Alarm	STO/DB	Each axis	×	×	×	×	○	—	○
	521.B	Alarm	STO/DB	Each axis	×	×	×	×	○	—	○
522	522.1	Alarm	STO/DB	Each axis	×	×	×	×	○	—	○
	522.2	Alarm	STO/DB	Each axis	×	×	×	×	○	—	○
	522.3	Alarm	STO/DB	Each axis	×	×	×	×	○	—	○
	522.4	Alarm	STO/DB	Each axis	×	×	×	×	○	—	○
	522.9	Alarm	STO/DB	Each axis	×	×	×	×	○	—	○
	522.A	Alarm	STO/DB	Each axis	×	×	×	×	○	—	○
	522.B	Alarm	STO/DB	Each axis	×	×	×	×	○	—	○
	522.C	Alarm	STO/DB	Each axis	×	×	×	×	○	—	○
523	523.1	Alarm	STO/DB	Each axis	×	×	×	×	○	—	○
	523.2	Alarm	STO/DB	Each axis	×	×	×	×	○	—	○
	523.3	Alarm	STO/DB	Each axis	×	×	×	×	○	—	○
	523.4	Alarm	STO/DB	Each axis	×	×	×	×	○	—	○
	523.9	Alarm	STO/DB	Each axis	×	×	×	×	○	—	○
	523.A	Alarm	STO/DB	Each axis	×	×	×	×	○	—	○
	523.B	Alarm	STO/DB	Each axis	×	×	×	×	○	—	○
	523.C	Alarm	STO/DB	Each axis	×	×	×	×	○	—	○
524	524.1	Alarm	STO/DB	Each axis	×	×	×	×	○	—	○
	524.2	Alarm	STO/DB	Each axis	×	×	×	×	○	—	○
	524.3	Alarm	STO/DB	Each axis	×	×	×	×	○	—	○
	524.4	Alarm	STO/DB	Each axis	×	×	×	×	○	—	○
	524.9	Alarm	STO/DB	Each axis	×	×	×	×	○	—	○
	524.A	Alarm	STO/DB	Each axis	×	×	×	×	○	—	○
	524.B	Alarm	STO/DB	Each axis	×	×	×	×	○	—	○
	524.C	Alarm	STO/DB	Each axis	×	×	×	×	○	—	○
525	525.1	Alarm	STO/DB	Each axis	×	×	×	×	○	—	○
	525.2	Alarm	STO/DB	Each axis	×	×	×	×	○	—	○
	525.3	Alarm	STO/DB	Each axis	×	×	×	×	○	—	○
	525.4	Alarm	STO/DB	Each axis	×	×	×	×	○	—	○
	525.9	Alarm	STO/DB	Each axis	×	×	×	×	○	—	○
	525.A	Alarm	STO/DB	Each axis	×	×	×	×	○	—	○
	525.B	Alarm	STO/DB	Each axis	×	×	×	×	○	—	○
	525.C	Alarm	STO/DB	Each axis	×	×	×	×	○	—	○

No.	Detail No.	Alarm/Warning	Motor stop method	Stop system	Converter main circuit stop target	Alarm deactivation				Motor stop warning	Safety sub-function stopped
						Safety reset	Alarm reset	Communication reset	Power cycling		
526	526.1	Alarm	STO/DB	Each axis	×	×	×	×	○	—	○
	526.2	Alarm	STO/DB	Each axis	×	×	×	×	○	—	○
	526.3	Alarm	STO/DB	Each axis	×	×	×	×	○	—	○
	526.4	Alarm	STO/DB	Each axis	×	×	×	×	○	—	○
	526.9	Alarm	STO/DB	Each axis	×	×	×	×	○	—	○
	526.A	Alarm	STO/DB	Each axis	×	×	×	×	○	—	○
	526.B	Alarm	STO/DB	Each axis	×	×	×	×	○	—	○
	526.C	Alarm	STO/DB	Each axis	×	×	×	×	○	—	○
527	527.1	Alarm	STO/DB	Each axis	×	×	×	×	○	—	○
	527.2	Alarm	STO/DB	Each axis	×	×	×	×	○	—	○
	527.3	Alarm	STO/DB	Each axis	×	×	×	×	○	—	○
	527.4	Alarm	STO/DB	Each axis	×	×	×	×	○	—	○
	527.9	Alarm	STO/DB	Each axis	×	×	×	×	○	—	○
	527.A	Alarm	STO/DB	Each axis	×	×	×	×	○	—	○
	527.B	Alarm	STO/DB	Each axis	×	×	×	×	○	—	○
	527.C	Alarm	STO/DB	Each axis	×	×	×	×	○	—	○
528	528.1	Alarm	STO/DB	Each axis	×	×	×	×	○	—	○
	528.2	Alarm	STO/DB	Each axis	×	×	×	×	○	—	○
	528.3	Alarm	STO/DB	Each axis	×	×	×	×	○	—	○
	528.4	Alarm	STO/DB	Each axis	×	×	×	×	○	—	○
	528.9	Alarm	STO/DB	Each axis	×	×	×	×	○	—	○
	528.A	Alarm	STO/DB	Each axis	×	×	×	×	○	—	○
	528.B	Alarm	STO/DB	Each axis	×	×	×	×	○	—	○
	528.C	Alarm	STO/DB	Each axis	×	×	×	×	○	—	○
529	529.1	Alarm	STO/DB	Each axis	×	×	×	×	○	—	○
	529.9	Alarm	STO/DB	Each axis	×	×	×	×	○	—	○
52A	52A.1	Alarm	STO/DB	Each axis	×	×	×	×	○	—	○
	52A.9	Alarm	STO/DB	Each axis	×	×	×	×	○	—	○
52B	52B.1	Alarm	STO/DB	Each axis	×	×	×	×	○	—	○
	52B.9	Alarm	STO/DB	Each axis	×	×	×	×	○	—	○
537	537.1	Alarm	STO/DB	Each axis	×	×	×	×	○	—	○
	537.2	Alarm	STO/DB	Each axis	×	×	×	×	○	—	○
	537.3	Alarm	STO/DB	Each axis	×	×	×	×	○	—	○
	537.9	Alarm	STO/DB	Each axis	×	×	×	×	○	—	○
	537.A	Alarm	STO/DB	Each axis	×	×	×	×	○	—	○
53A	53A.2	Alarm	STO/DB	All axes	○	×	×	×	○	—	○
	53A.A	Alarm	STO/DB	All axes	○	×	×	×	○	—	○
540	540.1	Alarm	STO/DB	All axes	○	×	×	×	○	—	○
	540.2	Alarm	STO/DB	All axes	○	×	×	×	○	—	○
	540.3	Alarm	STO/DB	All axes	○	×	×	×	○	—	○
	540.4	Alarm	STO/DB	All axes	○	×	×	×	○	—	○
	540.9	Alarm	STO/DB	All axes	○	×	×	×	○	—	○
	540.A	Alarm	STO/DB	All axes	○	×	×	×	○	—	○

No.	Detail No.	Alarm/Warning	Motor stop method	Stop system	Converter main circuit stop target	Alarm deactivation				Motor stop warning	Safety sub-function stopped
						Safety reset	Alarm reset	Communication reset	Power cycling		
541	541.1	Alarm	STO/DB	All axes	○	×	×	×	○	—	○
	541.2	Alarm	STO/DB	All axes	○	×	×	×	○	—	○
	541.3	Alarm	STO/DB	All axes	○	×	×	×	○	—	○
	541.4	Alarm	STO/DB	All axes	○	×	×	×	○	—	○
	541.5	Alarm	STO/DB	All axes	○	×	×	×	○	—	○
	541.9	Alarm	STO/DB	All axes	○	×	×	×	○	—	○
	541.A	Alarm	STO/DB	All axes	○	×	×	×	○	—	○
	541.B	Alarm	STO/DB	All axes	○	×	×	×	○	—	○
	541.C	Alarm	STO/DB	All axes	○	×	×	×	○	—	○
	541.D	Alarm	STO/DB	All axes	○	×	×	×	○	—	○
542	542.1	Alarm	STO/DB	All axes	○	×	×	×	○	—	○
	542.9	Alarm	STO/DB	All axes	○	×	×	×	○	—	○
543	543.1	Alarm	STO/DB	All axes	○	×	×	×	○	—	○
	543.2	Alarm	STO/DB	All axes	○	×	×	×	○	—	○
	543.3	Alarm	STO/DB	All axes	○	×	×	×	○	—	○
	543.9	Alarm	STO/DB	All axes	○	×	×	×	○	—	○
	543.A	Alarm	STO/DB	All axes	○	×	×	×	○	—	○
	543.B	Alarm	STO/DB	All axes	○	×	×	×	○	—	○
	543.C	Alarm	STO/DB	All axes	○	×	×	×	○	—	○
	543.D	Alarm	STO/DB	All axes	○	×	×	×	○	—	○
	543.E	Alarm	STO/DB	All axes	○	×	×	×	○	—	○
544	544.1	Alarm	SS1/SD	All axes	○	○	×	×	○	—	○
	544.2	Alarm	SS1/SD	All axes	○	○	×	×	○	—	○
	544.9	Alarm	SS1/SD	All axes	×	○	×	×	○	—	○
	544.A	Alarm	SS1/SD	All axes	×	○	×	×	○	—	○
545	545.2	Alarm	STO/DB	All axes	○	×	×	×	○	—	○
546	546.1	Alarm	STO/DB	All axes	○	×	×	×	○	—	○
	546.2	Alarm	STO/DB	All axes	○	×	×	×	○	—	○
	546.9	Alarm	STO/DB	All axes	○	×	×	×	○	—	○
	546.A	Alarm	STO/DB	All axes	○	×	×	×	○	—	○
547	547.1	Alarm	STO/DB	All axes	○	×	×	×	○	—	○
	547.2	Alarm	STO/DB	All axes	○	×	×	×	○	—	○
	547.9	Alarm	STO/DB	All axes	○	×	×	×	○	—	○
	547.A	Alarm	STO/DB	All axes	○	×	×	×	○	—	○
549	549.1	Alarm	STO/DB	All axes	○	×	×	×	○	—	○
	549.9	Alarm	STO/DB	All axes	○	×	×	×	○	—	○
54A	54A.1	Alarm	STO/DB	All axes	○	×	×	×	○	—	○
	54A.2	Alarm	STO/DB	All axes	○	×	×	×	○	—	○
	54A.3	Alarm	STO/DB	All axes	○	×	×	×	○	—	○
	54A.9	Alarm	STO/DB	All axes	○	×	×	×	○	—	○
	54A.A	Alarm	STO/DB	All axes	○	×	×	×	○	—	○
	54A.B	Alarm	STO/DB	All axes	○	×	×	×	○	—	○
54D	54D.1	Alarm	STO/DB	All axes	○	×	×	×	○	—	○
	54D.2	Alarm	STO/DB	All axes	○	×	×	×	○	—	○
	54D.3	Alarm	STO/DB	All axes	○	×	×	×	○	—	○
	54D.4	Alarm	STO/DB	All axes	○	×	×	×	○	—	○
	54D.9	Alarm	STO/DB	All axes	×	×	×	×	○	—	○
54F	54F.1	Alarm	STO/DB	All axes	○	×	×	×	○	—	○

No.	Detail No.	Alarm/Warning	Motor stop method	Stop system	Converter main circuit stop target	Alarm deactivation				Motor stop warning	Safety sub-function stopped
						Safety reset	Alarm reset	Communication reset	Power cycling		
550	550.1	Alarm	STO/DB	Each axis	×	×	×	×	○	—	○
	550.2	Alarm	STO/DB	Each axis	×	×	×	×	○	—	○
	550.3	Alarm	STO/DB	Each axis	×	×	×	×	○	—	○
	550.4	Alarm	STO/DB	Each axis	×	×	×	×	○	—	○
	550.9	Alarm	STO/DB	Each axis	×	×	×	×	○	—	○
	550.A	Alarm	STO/DB	Each axis	×	×	×	×	○	—	○
	550.B	Alarm	STO/DB	Each axis	×	×	×	×	○	—	○
	550.C	Alarm	STO/DB	Each axis	×	×	×	×	○	—	○
551	551.1	Alarm	STO/DB	Each axis	×	×	×	×	○	—	○
	551.2	Alarm	STO/DB	Each axis	×	×	×	×	○	—	○
	551.3	Alarm	STO/DB	Each axis	×	×	×	×	○	—	○
	551.4	Alarm	STO/DB	Each axis	×	×	×	×	○	—	○
	551.9	Alarm	STO/DB	Each axis	×	×	×	×	○	—	○
	551.A	Alarm	STO/DB	Each axis	×	×	×	×	○	—	○
	551.B	Alarm	STO/DB	Each axis	×	×	×	×	○	—	○
	551.C	Alarm	STO/DB	Each axis	×	×	×	×	○	—	○
552	552.1	Alarm	STO/DB	Each axis	×	×	×	×	○	—	○
	552.9	Alarm	STO/DB	Each axis	×	×	×	×	○	—	○
553	553.1	Alarm	SS1/SD	All axes	○	×	×	×	○	—	○
	553.2	Alarm	SS1/SD	All axes	○	×	×	×	○	—	○
	553.3	Alarm	SS1/SD	All axes	○	×	×	×	○	—	○
	553.9	Alarm	SS1/SD	All axes	○	×	×	×	○	—	○
	553.A	Alarm	SS1/SD	All axes	○	×	×	×	○	—	○
	553.B	Alarm	SS1/SD	All axes	○	×	×	×	○	—	○
554	554.1	Alarm	SS1/SD	All axes	○	×	×	×	○	—	○
	554.2	Alarm	SS1/SD	All axes	○	×	×	×	○	—	○
	554.3	Alarm	SS1/SD	All axes	○	×	×	×	○	—	○
	554.9	Alarm	SS1/SD	All axes	○	×	×	×	○	—	○
	554.A	Alarm	SS1/SD	All axes	○	×	×	×	○	—	○
	554.B	Alarm	SS1/SD	All axes	○	×	×	×	○	—	○
555	555.1	Alarm	SS1/SD	All axes	○	×	×	×	○	—	○
	555.2	Alarm	SS1/SD	All axes	○	×	×	×	○	—	○
	555.3	Alarm	SS1/SD	All axes	○	×	×	×	○	—	○
	555.9	Alarm	SS1/SD	All axes	○	×	×	×	○	—	○
	555.A	Alarm	SS1/SD	All axes	○	×	×	×	○	—	○
	555.B	Alarm	SS1/SD	All axes	○	×	×	×	○	—	○
556	556.1	Alarm	SS1/SD	All axes	○	×	×	×	○	—	○
	556.2	Alarm	SS1/SD	All axes	○	×	×	×	○	—	○
	556.3	Alarm	SS1/SD	All axes	○	×	×	×	○	—	○
	556.9	Alarm	SS1/SD	All axes	○	×	×	×	○	—	○
	556.A	Alarm	SS1/SD	All axes	○	×	×	×	○	—	○
	556.B	Alarm	SS1/SD	All axes	○	×	×	×	○	—	○
557	557.1	Alarm	SS1/SD	All axes	○	×	×	×	○	—	○
	557.2	Alarm	SS1/SD	All axes	○	×	×	×	○	—	○
	557.3	Alarm	SS1/SD	All axes	○	×	×	×	○	—	○
	557.9	Alarm	SS1/SD	All axes	○	×	×	×	○	—	○
	557.A	Alarm	SS1/SD	All axes	○	×	×	×	○	—	○
	557.B	Alarm	SS1/SD	All axes	○	×	×	×	○	—	○

No.	Detail No.	Alarm/Warning	Motor stop method	Stop system	Converter main circuit stop target	Alarm deactivation				Motor stop warning	Safety sub-function stopped
						Safety reset	Alarm reset	Communication reset	Power cycling		
560	560.1	Alarm	STO/DB	Each axis	×	○	×	×	○	—	×
	560.2	Alarm	STO/DB	Each axis	×	○	×	×	○	—	×
	560.3	Alarm	STO/DB	Each axis	×	○	×	×	○	—	×
	560.9	Alarm	STO/DB	Each axis	×	○	×	×	○	—	×
	560.A	Alarm	STO/DB	Each axis	×	○	×	×	○	—	×
	560.B	Alarm	STO/DB	Each axis	×	○	×	×	○	—	×
561	561.1	Alarm	STO/DB	Each axis	×	○	×	×	○	—	×
	561.2	Alarm	STO/DB	Each axis	×	○	×	×	○	—	×
	561.3	Alarm	STO/DB	Each axis	×	○	×	×	○	—	×
	561.4	Alarm	STO/DB	Each axis	×	○	×	×	○	—	×
	561.9	Alarm	STO/DB	Each axis	×	○	×	×	○	—	×
	561.A	Alarm	STO/DB	Each axis	×	○	×	×	○	—	×
	561.B	Alarm	STO/DB	Each axis	×	○	×	×	○	—	×
	561.C	Alarm	STO/DB	Each axis	×	○	×	×	○	—	×
562	562.1	Alarm	STO/DB	Each axis	×	○	×	×	○	—	×
	562.2	Alarm	STO/DB	Each axis	×	○	×	×	○	—	×
	562.3	Alarm	STO/DB	Each axis	×	○	×	×	○	—	×
	562.4	Alarm	STO/DB	Each axis	×	○	×	×	○	—	×
	562.9	Alarm	STO/DB	Each axis	×	○	×	×	○	—	×
	562.A	Alarm	STO/DB	Each axis	×	○	×	×	○	—	×
	562.B	Alarm	STO/DB	Each axis	×	○	×	×	○	—	×
	562.C	Alarm	STO/DB	Each axis	×	○	×	×	○	—	×
563	563.1	Alarm	STO/DB	Each axis	×	○	×	×	○	—	×
	563.2	Alarm	STO/DB	Each axis	×	○	×	×	○	—	×
	563.3	Alarm	STO/DB	Each axis	×	○	×	×	○	—	×
	563.4	Alarm	STO/DB	Each axis	×	○	×	×	○	—	×
	563.9	Alarm	STO/DB	Each axis	×	○	×	×	○	—	×
	563.A	Alarm	STO/DB	Each axis	×	○	×	×	○	—	×
	563.B	Alarm	STO/DB	Each axis	×	○	×	×	○	—	×
	563.C	Alarm	STO/DB	Each axis	×	○	×	×	○	—	×
564	564.1	Alarm	STO/DB	Each axis	×	○	×	×	○	—	×
	564.9	Alarm	STO/DB	Each axis	×	○	×	×	○	—	×
565	565.1	Alarm	STO/DB	Each axis	×	○	×	×	○	—	×
	565.2	Alarm	STO/DB	Each axis	×	○	×	×	○	—	×
	565.3	Alarm	STO/DB	Each axis	×	○	×	×	○	—	×
	565.4	Alarm	STO/DB	Each axis	×	○	×	×	○	—	×
	565.9	Alarm	STO/DB	Each axis	×	○	×	×	○	—	×
	565.A	Alarm	STO/DB	Each axis	×	○	×	×	○	—	×
	565.B	Alarm	STO/DB	Each axis	×	○	×	×	○	—	×
565.C	Alarm	STO/DB	Each axis	×	○	×	×	○	—	×	
568	568.1	Alarm	STO/DB	Each axis	×	○	×	×	○	—	×
	568.2	Alarm	STO/DB	Each axis	×	○	×	×	○	—	×
	568.3	Alarm	STO/DB	Each axis	×	○	×	×	○	—	×
	568.4	Alarm	STO/DB	Each axis	×	○	×	×	○	—	×
	568.9	Alarm	STO/DB	Each axis	×	○	×	×	○	—	×
	568.A	Alarm	STO/DB	Each axis	×	○	×	×	○	—	×
	568.B	Alarm	STO/DB	Each axis	×	○	×	×	○	—	×
568.C	Alarm	STO/DB	Each axis	×	○	×	×	○	—	×	

No.	Detail No.	Alarm/Warning	Motor stop method	Stop system	Converter main circuit stop target	Alarm deactivation				Motor stop warning	Safety sub-function stopped
						Safety reset	Alarm reset	Communication reset	Power cycling		
569	569.1	Alarm	STO/DB	Each axis	×	○	×	×	○	—	×
	569.2	Alarm	STO/DB	Each axis	×	○	×	×	○	—	×
	569.3	Alarm	STO/DB	Each axis	×	○	×	×	○	—	×
	569.4	Alarm	STO/DB	Each axis	×	○	×	×	○	—	×
	569.9	Alarm	STO/DB	Each axis	×	○	×	×	○	—	×
	569.A	Alarm	STO/DB	Each axis	×	○	×	×	○	—	×
	569.B	Alarm	STO/DB	Each axis	×	○	×	×	○	—	×
	569.C	Alarm	STO/DB	Each axis	×	○	×	×	○	—	×
580	580.3	Alarm	SS1/SD	All axes	○	○	×	×	○	—	○
	580.B	Alarm	SS1/SD	All axes	○	○	×	×	○	—	○
581	581.1	Alarm	SS1/SD	All axes	○	○	×	×	○	—	○
	581.2	Alarm	SS1/SD	All axes	○	○	×	×	○	—	○
	581.3	Alarm	SS1/SD	All axes	○	○	×	×	○	—	○
	581.4	Alarm	SS1/SD	All axes	○	○	×	×	○	—	○
	581.5	Alarm	SS1/SD	All axes	○	○	×	×	○	—	○
	581.6	Alarm	SS1/SD	All axes	○	○	×	×	○	—	○
	581.7	Alarm	SS1/SD	All axes	○	○	×	×	○	—	○
	581.9	Alarm	SS1/SD	All axes	○	○	×	×	○	—	○
	581.A	Alarm	SS1/SD	All axes	○	○	×	×	○	—	○
	581.B	Alarm	SS1/SD	All axes	○	○	×	×	○	—	○
	581.C	Alarm	SS1/SD	All axes	○	○	×	×	○	—	○
	581.D	Alarm	SS1/SD	All axes	○	○	×	×	○	—	○
	581.E	Alarm	SS1/SD	All axes	○	○	×	×	○	—	○
	581.F	Alarm	SS1/SD	All axes	○	○	×	×	○	—	○
	582	582.1	Alarm	SS1/SD	All axes	○	○	×	×	○	—
582.2		Alarm	SS1/SD	All axes	○	○	×	×	○	—	○
582.3		Alarm	SS1/SD	All axes	○	○	×	×	○	—	○
582.4		Alarm	SS1/SD	All axes	○	○	×	×	○	—	○
582.5		Alarm	SS1/SD	All axes	○	○	×	×	○	—	○
582.6		Alarm	SS1/SD	All axes	○	○	×	×	○	—	○
582.7		Alarm	SS1/SD	All axes	○	○	×	×	○	—	○
582.9		Alarm	SS1/SD	All axes	○	○	×	×	○	—	○
582.A		Alarm	SS1/SD	All axes	○	○	×	×	○	—	○
582.B		Alarm	SS1/SD	All axes	○	○	×	×	○	—	○
582.C		Alarm	SS1/SD	All axes	○	○	×	×	○	—	○
582.D		Alarm	SS1/SD	All axes	○	○	×	×	○	—	○
582.E		Alarm	SS1/SD	All axes	○	○	×	×	○	—	○
582.F		Alarm	SS1/SD	All axes	○	○	×	×	○	—	○
583	583.2	Alarm	SS1/SD	All axes	○	○	×	×	○	—	○
	583.3	Alarm	SS1/SD	All axes	○	○	×	×	○	—	○
	583.4	Alarm	SS1/SD	All axes	○	○	×	×	○	—	○
	583.5	Alarm	SS1/SD	All axes	○	○	×	×	○	—	○
	583.6	Alarm	SS1/SD	All axes	○	○	×	×	○	—	○
	583.A	Alarm	SS1/SD	All axes	○	○	×	×	○	—	○
	583.B	Alarm	SS1/SD	All axes	○	○	×	×	○	—	○
	583.C	Alarm	SS1/SD	All axes	○	○	×	×	○	—	○
	583.D	Alarm	SS1/SD	All axes	○	○	×	×	○	—	○
	583.E	Alarm	SS1/SD	All axes	○	○	×	×	○	—	○

No.	Detail No.	Alarm/Warning	Motor stop method	Stop system	Converter main circuit stop target	Alarm deactivation				Motor stop warning	Safety sub-function stopped
						Safety reset	Alarm reset	Communication reset	Power cycling		
584	584.1	Alarm	SS1/SD	All axes	○	○	×	×	○	—	○
	584.2	Alarm	SS1/SD	All axes	○	○	×	×	○	—	○
	584.3	Alarm	SS1/SD	All axes	○	○	×	×	○	—	○
	584.4	Alarm	SS1/SD	All axes	○	○	×	×	○	—	○
	584.5	Alarm	SS1/SD	All axes	○	○	×	×	○	—	○
	584.9	Alarm	SS1/SD	All axes	○	○	×	×	○	—	○
	584.A	Alarm	SS1/SD	All axes	○	○	×	×	○	—	○
	584.B	Alarm	SS1/SD	All axes	○	○	×	×	○	—	○
	584.C	Alarm	SS1/SD	All axes	○	○	×	×	○	—	○
	584.D	Alarm	SS1/SD	All axes	○	○	×	×	○	—	○
585	585.1	Alarm	SS1/SD	All axes	○	○	×	×	○	—	○
	585.2	Alarm	SS1/SD	All axes	○	○	×	×	○	—	○
	585.3	Alarm	SS1/SD	All axes	○	○	×	×	○	—	○
	585.4	Alarm	SS1/SD	All axes	○	○	×	×	○	—	○
	585.9	Alarm	SS1/SD	All axes	○	○	×	×	○	—	○
	585.A	Alarm	SS1/SD	All axes	○	○	×	×	○	—	○
	585.B	Alarm	SS1/SD	All axes	○	○	×	×	○	—	○
	585.C	Alarm	SS1/SD	All axes	○	○	×	×	○	—	○
586	586.1	Alarm	SS1/SD	All axes	○	○	×	×	○	—	○
	586.2	Alarm	SS1/SD	All axes	○	○	×	×	○	—	○
	586.3	Alarm	SS1/SD	All axes	○	○	×	×	○	—	○
	586.4	Alarm	SS1/SD	All axes	○	○	×	×	○	—	○
	586.5	Alarm	SS1/SD	All axes	○	○	×	×	○	—	○
	586.9	Alarm	SS1/SD	All axes	○	○	×	×	○	—	○
	586.A	Alarm	SS1/SD	All axes	○	○	×	×	○	—	○
	586.B	Alarm	SS1/SD	All axes	○	○	×	×	○	—	○
	586.C	Alarm	SS1/SD	All axes	○	○	×	×	○	—	○
	586.D	Alarm	SS1/SD	All axes	○	○	×	×	○	—	○
587	587.1	Alarm	SS1/SD	All axes	○	×	×	×	○	—	○
	587.2	Alarm	SS1/SD	All axes	○	×	×	×	○	—	○
	587.3	Alarm	SS1/SD	All axes	○	×	×	×	○	—	○
	587.4	Alarm	SS1/SD	All axes	○	×	×	×	○	—	○
	587.5	Alarm	SS1/SD	All axes	○	×	×	×	○	—	○
	587.6	Alarm	SS1/SD	All axes	○	×	×	×	○	—	○
	587.7	Alarm	SS1/SD	All axes	○	×	×	×	○	—	○
	587.9	Alarm	SS1/SD	All axes	○	×	×	×	○	—	○
	587.A	Alarm	SS1/SD	All axes	○	×	×	×	○	—	○
	587.B	Alarm	SS1/SD	All axes	○	×	×	×	○	—	○
	587.C	Alarm	SS1/SD	All axes	○	×	×	×	○	—	○
	587.D	Alarm	SS1/SD	All axes	○	×	×	×	○	—	○
	587.E	Alarm	SS1/SD	All axes	○	×	×	×	○	—	○
	587.F	Alarm	SS1/SD	All axes	○	×	×	×	○	—	○
595	595.1	Warning	STO/DB	Each axis	×	—	—	—	—	○	×
	595.9	Warning	STO/DB	Each axis	×	—	—	—	—	○	×
596	596.1	Warning	STO/DB	Each axis	×	—	—	—	—	○	×
	596.9	Warning	STO/DB	Each axis	×	—	—	—	—	○	×

No.	Detail No.	Alarm/Warning	Motor stop method	Stop system	Converter main circuit stop target	Alarm deactivation				Motor stop warning	Safety sub-function stopped
						Safety reset	Alarm reset	Communication reset	Power cycling		
59D	59D.1	Warning	STO/DB	All axes	○	×	—	—	—	○	○
	59D.3	Warning	STO/DB	All axes	○	×	—	—	—	○	○
	59D.6	Warning	STO/DB	All axes	○	×	—	—	—	○	○
	59D.9	Warning	STO/DB	All axes	○	×	—	—	—	○	○
	59D.B	Warning	STO/DB	All axes	○	×	—	—	—	○	○
	59D.E	Warning	STO/DB	All axes	○	×	—	—	—	○	○
5E0	5E0.1	Warning	STO/DB	All axes	○	—	—	—	—	○	○
	5E0.2	Warning	STO/DB	All axes	○	—	—	—	—	○	○
	5E0.3	Warning	STO/DB	All axes	○	—	—	—	—	○	○
	5E0.7	Warning	STO/DB	All axes	○	—	—	—	—	○	○
	5E0.9	Warning	STO/DB	All axes	○	—	—	—	—	○	○
	5E0.A	Warning	STO/DB	All axes	○	—	—	—	—	○	○
	5E0.B	Warning	STO/DB	All axes	○	—	—	—	—	○	○
	5E0.F	Warning	STO/DB	All axes	○	—	—	—	—	○	○
5E1	5E1.1	Warning	STO/DB	Each axis	×	—	—	—	—	○	×
	5E1.9	Warning	STO/DB	Each axis	×	—	—	—	—	○	×
5E2	5E2.1	Warning	SS1/SD	All axes	○	—	—	—	—	○	○
	5E2.2	Warning	SS1/SD	All axes	○	—	—	—	—	○	○
	5E2.9	Warning	SS1/SD	All axes	×	—	—	—	—	○	○
	5E2.A	Warning	SS1/SD	All axes	×	—	—	—	—	○	×
5E6	5E6.1	Warning	SS1/SD	Each axis	×	—	—	—	—	○	×
	5E6.9	Warning	SS1/SD	Each axis	×	—	—	—	—	○	×

*1 Because the servo motor is stopped when this alarm is detected, there is no "Motor stop method".
 *2 For details of "Motor stop method", refer to "Stop method at stroke limit detection" in the following manual.
 📖 MR-J5 User's Manual (Function)

1.3 Handling methods for alarms/warnings

Remove the cause of the alarm and warning in accordance with this section. MR Configurator2 can be referenced to find the causes of alarms and warnings.

[AL. 010_Undervoltage]

- The voltage of the control circuit power supply has dropped.
- The voltage of the main circuit power supply has dropped.

[AL. 010.1_Voltage drop in the control circuit power]

Cause	Check/action method	Model
1. Connection or wiring of the control circuit power supply is incorrect.	Check the connection and wiring of the control circuit power supply (screw tightening state on the power supply route, disconnected cables, and loose connection of the servo amplifier connector). Refer to "Example power circuit connections" in the following manuals. □ MR-J5 User's Manual (Hardware) □ MR-J5D User's Manual (Hardware)	[G] [B] [A]
2. The voltage of the control circuit power supply is too low.	Check if the voltage of the control circuit power supply is equal to or lower than the specified value. 200 V class: 160 V AC 400 V class: 280 V AC	
3. The power was cycled before the internal control circuit power supply stopped.	After shutting off the servo amplifier power supply, make sure that the seven-segment LED of the servo amplifier is turned off, then cycle the power.	
4. An instantaneous power failure lasted for longer than the specified time. <ul style="list-style-type: none"> • When [Pr. PA20.2 SEMI-F47 function selection] is set to "0" (disabled), the specified time is 60 ms. • When [Pr. PA20.2] is set to "1" (enabled), the value set in [Pr. PF25 SEMI-F47 function - Instantaneous power failure detection time (Instantaneous power failure tough drive detection time)] is the specified time. 	Check if the power supply has a problem. After checking, cycle the power of the servo amplifier.	

[AL. 010.2_Voltage drop in the main circuit power]

Cause	Check/action method	Model
1. Connection or wiring of the main circuit power supply is incorrect.	Check the connection and wiring of the main circuit power supply (screw tightening state on the power supply route, disconnected cables, and loose connection of the servo amplifier connector). Refer to "Example power circuit connections" in the following manual. ☞MR-J5 User's Manual (Hardware)	[G] [B] [A]
2. The wiring between P3 and P4 is disconnected.	Check the wiring between P3 and P4. Refer to "Example power circuit connections" in the following manual. ☞MR-J5 User's Manual (Hardware)	
3. For the MR-J5D_, the wiring of the main circuit power supply of the converter unit is disconnected.	Check the wiring of the main circuit power supply of the converter unit. Refer to "Example power circuit connections" in the following manual. ☞MR-J5D User's Manual (Hardware)	[G]
4. For the MR-J5D_, the magnetic contactor control connector of the converter unit is disconnected.	Check the magnetic contactor control connector of the converter unit. Refer to "Magnetic contactor control connector (CN23)" in the following manual. ☞MR-CV Power Regeneration Converter Unit User's Manual	
5. For the MR-J5D_, the bus bar that connects the converter unit and the MR-J5D_ is disconnected.	Check if the bus bar has been installed correctly. Refer to "How to use the bus bar" in the following manual. ☞MR-J5D User's Manual (Hardware)	
6. The voltage of the main circuit power supply is too low. The main circuit power supply voltage (between P+ and N-) has dropped due to an instantaneous power failure or other reasons.	Check if the voltage of the main circuit power supply is equal to or lower than the specified value. When the voltage is equal to or lower than the specified value, increase the voltage of the main circuit power supply. 200 V class: 160 V AC 400 V class: 280 V AC If an instantaneous power failure is occurring, review the power supply environment.	[G] [B] [A]
7. When this alarm occurs, the bus voltage is too low at acceleration.	Check if the bus voltage during acceleration is lower than the specified value. If the bus voltage is lower than the specified value, increase the acceleration time constant or the power supply capacity. 200 V class: 200 V DC 400 V class: 380 V DC	
8. The fuse was disconnected.	Check the charge light after a certain period of time.	
9. The power supply capacity is insufficient.	Check if the specified power supply capacity is satisfied.	
10. Main circuit capacitor has deteriorated.	After checking the operation time and ambient temperature, replace the servo amplifier if the main circuit capacitor has reached the end of its service life. Refer to "Parts with a service life" in the User's Manual (Introduction).	
11. The servo amplifier has malfunctioned.	Check the value of the bus voltage. If the bus voltage is lower than the specified value even though the voltage of the main circuit power supply is within specifications, replace the servo amplifier. 200 V class: 200 V DC 400 V class: 380 V DC	
12. For the MR-J5D_, the converter unit has malfunctioned.	Replace the converter unit, then check the repeatability. If the error does not repeat, replace the converter unit.	[G]

[AL. 011_Switch setting error]

- The settings of the DIP switch are incorrect.
- The settings of the rotary switch are incorrect.

[AL. 011.1_Rotary switch setting error]

Cause	Check/action method	Model
<p>1. Each selected network has its settable range, and the values set with the rotary switches (SW1/SW2) were set out of the range.</p>	<p>Check the settings of the rotary switches (SW1/SW2). If the value set with the rotary switch does not match the actual value, the servo amplifier may have malfunctioned. Replace the servo amplifier. Specifications on the setting of the rotary switches vary depending on each network. Refer to "Switch setting and display of the servo amplifier" or "Switch setting and display of the drive unit" in the User's Manual (Introduction).</p>	<p>[G] [B]</p>

[AL. 011.2_Disabled axis setting error]

Cause	Check/action method	Model
<p>1. The settings of the disabling control axis switch are incorrect.</p>	<p>Check the setting of the disabling control axis switch. Refer to "Switch setting and display of the servo amplifier" or "Switch setting and display of the drive unit" in the User's Manual (Introduction). If the above case does not apply, the servo amplifier may have malfunctioned. Replace the servo amplifier.</p>	[G]
	<p>If the disabling control axis switch has been set as shown below, an alarm will occur.</p> <p>For 2-axis servo amplifiers</p> <ul style="list-style-type: none"> • The A-axis is disabled. • All axes are disabled. <p>For 3-axis servo amplifiers</p> <ul style="list-style-type: none"> • Only the A-axis is disabled. • Only the B-axis is disabled. • The A-axis and B-axis are disabled. • The A-axis and C-axis are disabled. • All axes are disabled. <p>If any of the above conditions is met, check the settings of the disabling control axis switch, and set them correctly. For information on the settings of the disabling control axis switch, refer to "Switch setting and display of the servo amplifier" in the User's Manual (Introduction). If an alarm still occurs even after the settings have been configured correctly, the servo amplifier may have malfunctioned. Replace the servo amplifier.</p>	[B]

[AL. 012_Memory error 1 (RAM)]

- The internal part of the servo amplifier (RAM) has malfunctioned.

[AL. 012.1_RAM error 1]

Cause	Check/action method	Model
1. An internal part of the servo amplifier has malfunctioned.	Noise from the power supply may have caused the failure. Disconnect all cables except for those for the control circuit power supply, then check the repeatability. If the failure continues, the servo amplifier may have malfunctioned. Replace the servo amplifier.	[G] [B] [A]
2. There is a problem with the surrounding environment.	Check the power supply for noise. If there is noise, take countermeasures to reduce the noise. Refer to "Noise reduction techniques" in the following manuals. <ul style="list-style-type: none"> 📖 MR-J5 User's Manual (Hardware) 📖 MR-J5D User's Manual (Hardware) 	

[AL. 012.2_RAM error 2]

📖 Page 35 [AL. 012.1_RAM error 1]

[AL. 012.4_RAM error 4]

📖 Page 35 [AL. 012.1_RAM error 1]

[AL. 012.5_RAM error 5]

📖 Page 35 [AL. 012.1_RAM error 1]

[AL. 012.6_RAM error 6]

📖 Page 35 [AL. 012.1_RAM error 1]

[AL. 012.7_RAM error 7]

📖 Page 35 [AL. 012.1_RAM error 1]

[AL. 012.8_RAM error 8]

📖 Page 35 [AL. 012.1_RAM error 1]



[AL. 012.9_RAM error 9]

📖 Page 35 [AL. 012.1_RAM error 1]

[AL. 013_CPU error]

- An internal part of the servo amplifier has malfunctioned.
- A clock transmitted from the controller has an error.

[AL. 013.1_CPU error 1]

Cause	Check/action method	Model
1. An internal part of the servo amplifier has malfunctioned.	Noise from the power supply may have caused the failure. Disconnect all cables except for those for the control circuit power supply, then check the repeatability. If the failure continues, replace the servo amplifier.	[G] [B] [A]
2. A clock transmitted from the controller has an error.	Check if this alarm occurs when the servo amplifier is connected to the controller. If the alarm occurs, replace the controller.	[G] [B]
3. The servo amplifier of the next axis has malfunctioned.	Replace the servo amplifier of the next axis, then check the repeatability.	
4. There is a problem with the surrounding environment.	Check the power supply for noise. If there is noise, take countermeasures to reduce the noise. Check if the connector has shorted. Refer to "Noise reduction techniques" in the following manuals.  MR-J5 User's Manual (Hardware)  MR-J5D User's Manual (Hardware)	[G] [B] [A]

[AL. 013.2_CPU error 2]

 Page 36 [AL. 013.1_CPU error 1]

[AL. 013.4_CPU error 4]

 Page 36 [AL. 013.1_CPU error 1]

[AL. 013.5_CPU error 5]

 Page 36 [AL. 013.1_CPU error 1]

[AL. 014_Control process error]

- The process did not complete within the specified time.
- The internal part of the servo amplifier (communication IC) has malfunctioned. [G]

[AL. 014.1_Control process error 1]

Cause	Check/action method	Model
1. The servo parameter settings are incorrect.	Return the servo parameter to the value it had before the alarm occurrence, then check if the problem occurs again.	[G] [B] [A]
2. There is a problem with the surrounding environment.	Check the power supply for noise. If there is noise, take countermeasures to reduce the noise. Check if the connector has shorted. Refer to "Noise reduction techniques" in the following manuals. <ul style="list-style-type: none"> ☞MR-J5 User's Manual (Hardware) ☞MR-J5D User's Manual (Hardware) 	
3. The servo amplifier has malfunctioned.	Replace the servo amplifier.	

[AL. 014.2_Control process error 2]

Cause	Check/action method	Model
1. A synchronous signal transmitted from the controller has an error.	Replace the controller, then check the repeatability.	[G] [B]
2. The servo parameter settings are incorrect.	Return the servo parameter to the value it had before the alarm occurrence, then check if the problem occurs again.	[G] [B] [A]
3. There is a problem with the surrounding environment.	Check the power supply for noise. If there is noise, take countermeasures to reduce the noise. Check if the connector has shorted. Refer to "Noise reduction techniques" in the following manuals. <ul style="list-style-type: none"> ☞MR-J5 User's Manual (Hardware) ☞MR-J5D User's Manual (Hardware) 	
4. The servo amplifier has malfunctioned.	Replace the servo amplifier.	

[AL. 014.3_Control process error 3]

☞ Page 37 [AL. 014.1_Control process error 1]

[AL. 014.4_Control process error 4]

☞ Page 37 [AL. 014.1_Control process error 1]

[AL. 014.5_Control process error 5]

☞ Page 37 [AL. 014.1_Control process error 1]

[AL. 014.8_Control process error 8]

☞ Page 37 [AL. 014.1_Control process error 1]

[AL. 014.9_Control process error 9]

☞ Page 37 [AL. 014.1_Control process error 1]

[AL. 014.C_Control process error 12]

☞ Page 37 [AL. 014.1_Control process error 1]

[AL. 016_ Encoder initial communication error 1]

- There is a communication error between the encoder and servo amplifier.

[AL. 016.1_ Encoder initial communication - Receive data error 1]

Cause	Check/action method	Model
1. There is a problem with the encoder cable.	Check if the encoder cable has been disconnected, incorrectly wired, or has shorted. If there is a problem with the encoder cable, replace or repair the cable. Refer to "A/B/Z-phase differential output type encoder" in the following manual. MR-J5 Partner's Encoder User's Manual	[G] [B] [A]
2. If an A/B/Z-phase differential output type encoder is being used on the servo motor side, the servo amplifier is not compatible with the A/B/Z-phase differential output type encoder.	Check if the servo amplifier is compatible with the A/B/Z-phase differential output type encoder. Refer to "Compatible encoder list" in the following manual. MR-J5 Partner's Encoder User's Manual	
3. If an A/B/Z-phase differential output type encoder is being used on the servo motor side, the connection with the encoder is incorrect.	Check if the wiring of the A/B/Z-phase differential output type encoder is correct. Check if the encoder is wired to PSEL. Refer to "A/B/Z-phase differential output type encoder" in the following manual. MR-J5 Partner's Encoder User's Manual	
4. The servo amplifier has malfunctioned.	Replace the servo amplifier.	
5. The encoder has malfunctioned.	Replace the servo motor.	
6. There is a problem with the surrounding environment.	Check the power supply for noise. If there is noise, take countermeasures to reduce the noise. Check if the connector has shorted. Refer to "Noise reduction techniques" in the following manuals. MR-J5 User's Manual (Hardware) MR-J5D User's Manual (Hardware)	

[AL. 016.2_ Encoder initial communication - Receive data error 2]

Page 38 [AL. 016.1_ Encoder initial communication - Receive data error 1]

[AL. 016.3_Encoder initial communication - Receive data error 3]

Cause	Check/action method	Model
1. For a multi-axis servo amplifier, unused axes have not been disabled.	Set the axis not used to disabled with disabling control axis switch (SW3-2/SW3-3/SW3-4).	[G] [B]
2. The encoder cable is disconnected.	Check if the encoder cable is connected correctly.	[G] [B] [A]
3. The servo parameter settings for the communication method are incorrect.	Set the servo parameter correctly according to the encoder cable communication method (two-wire type/four-wire type). [G] [B]: [Pr. PC04.3 Encoder cable communication method selection] [A]: [Pr. PC22.3 Encoder cable communication method selection]	
4. There is a problem with the encoder cable.	Check if the encoder cable has been disconnected or has shorted. If there is a problem with the encoder cable, replace or repair the cable.	
5. If an A/B/Z-phase differential output type encoder is being used on the servo motor side, the connection with the encoder is incorrect.	Check if the wiring of the A/B/Z-phase differential output type encoder is correct. Check if the encoder is wired to PSEL. Refer to "A/B/Z-phase differential output type encoder" in the following manual. MR-J5 Partner's Encoder User's Manual	
6. The voltage of the control circuit power supply has become unstable.	Check the voltage of the control circuit power supply. If an instantaneous power failure is occurring in the control circuit power supply, review the power supply environment.	
7. The servo amplifier has malfunctioned.	Replace the servo amplifier.	
8. The encoder has malfunctioned.	Replace the servo motor.	
9. There is a problem with the surrounding environment.	Check the power supply for noise. If there is noise, take countermeasures to reduce the noise. Check if the connector has shorted. Refer to "Noise reduction techniques" in the following manuals. MR-J5 User's Manual (Hardware) MR-J5D User's Manual (Hardware)	

[AL. 016.5_Encoder initial communication - Transmission data error 1]

Page 38 [AL. 016.1_Encoder initial communication - Receive data error 1]

[AL. 016.6_Encoder initial communication - Transmission data error 2]

Page 38 [AL. 016.1_Encoder initial communication - Receive data error 1]

[AL. 016.7_Encoder initial communication - Transmission data error 3]

Page 38 [AL. 016.1_Encoder initial communication - Receive data error 1]

[AL. 016.A_Encoder initial communication - Process error 1]

Cause	Check/action method	Model
1. The servo amplifier has malfunctioned.	Replace the servo amplifier.	[G] [B] [A]
2. The encoder has malfunctioned.	Replace the servo motor.	
3. There is a problem with the surrounding environment.	Check the power supply for noise. If there is noise, take countermeasures to reduce the noise. Check if the connector has shorted. Refer to "Noise reduction techniques" in the following manuals. MR-J5 User's Manual (Hardware) MR-J5D User's Manual (Hardware)	

[AL. 016.B_Encoder initial communication - Process error 2]

☞ Page 39 [AL. 016.A_Encoder initial communication - Process error 1]

[AL. 016.C_Encoder initial communication - Process error 3]

☞ Page 39 [AL. 016.A_Encoder initial communication - Process error 1]

[AL. 016.D_Encoder initial communication - Process error 4]

☞ Page 39 [AL. 016.A_Encoder initial communication - Process error 1]

[AL. 016.E_Encoder initial communication - Process error 5]

☞ Page 39 [AL. 016.A_Encoder initial communication - Process error 1]



[AL. 016.F_Encoder initial communication - Process error 6]

☞ Page 39 [AL. 016.A_Encoder initial communication - Process error 1]

[AL. 017_Board error]

- There is a problem with an internal part of the servo amplifier.



[AL. 017.1_Board error 1]

Cause	Check/action method	Model
1. There is a problem with the current detection circuit.	Check that this alarm occurs in the servo-on status. If the alarm occurs, the servo amplifier may have malfunctioned. Replace the servo amplifier.	[G] [B] [A]
2. There is a problem with the surrounding environment.	Check the noise, ambient temperature, and other conditions, and implement appropriate countermeasures for the cause. If there is noise, take countermeasures to reduce the noise. Refer to "Noise reduction techniques" in the following manuals.  MR-J5 User's Manual (Hardware)  MR-J5D User's Manual (Hardware)	



[AL. 017.3_Board error 2]

 Page 41 [AL. 017.1_Board error 1]



[AL. 017.4_Board error 3]

Cause	Check/action method	Model
1. The firmware version of the servo amplifier is not supported.	The firmware version is not supported. Perform a firmware update to revert to the firmware version prior to the update.	[G] [B] [A]
2. The recognition signal of the servo amplifier was not read properly.	Disconnect all cables except for those for the control circuit power supply, then check the repeatability. If the failure continues, the servo amplifier may have malfunctioned. Replace the servo amplifier.	
3. There is a problem with the surrounding environment.	Check the noise, ambient temperature, and other conditions, and implement appropriate countermeasures for the cause. If there is noise, take countermeasures to reduce the noise. Refer to "Noise reduction techniques" in the following manuals.  MR-J5 User's Manual (Hardware)  MR-J5D User's Manual (Hardware)	



[AL. 017.5_Board error 4]

Cause	Check/action method	Model
1. There is a problem with rotary switches (SW1/SW2).	After checking the conditions of the rotary switches, cycle the power, then check the repeatability. If the failure continues, the servo amplifier may have malfunctioned. Replace the servo amplifier.	[G] [B]
2. There is a problem with the surrounding environment.	Check the noise, ambient temperature, and other conditions, and implement appropriate countermeasures for the cause. If there is noise, take countermeasures to reduce the noise. Refer to "Noise reduction techniques" in the following manuals.  MR-J5 User's Manual (Hardware)  MR-J5D User's Manual (Hardware)	



[AL. 017.6_Board error 5]

Cause	Check/action method	Model
1. There is a problem with the DIP switch (SW3).	After checking the conditions of the DIP switch, cycle the power, then check the repeatability. If the failure continues, the servo amplifier may have malfunctioned. Replace the servo amplifier.	[G] [B]
2. There is a problem with the surrounding environment.	Check the noise, ambient temperature, and other conditions, and implement appropriate countermeasures for the cause. If there is noise, take countermeasures to reduce the noise. Refer to "Noise reduction techniques" in the following manuals.  MR-J5 User's Manual (Hardware)  MR-J5D User's Manual (Hardware)	

[AL. 017.7_Board error 7]

Cause	Check/action method	Model
1. The firmware version of the servo amplifier is not supported.	The firmware version is not supported. Perform a firmware update to revert to the firmware version prior to the update.	[G] [B] [A]
2. The recognition signal of the servo amplifier was not read properly.	Disconnect all cables except for those for the control circuit power supply, then check the repeatability. If the failure continues, the servo amplifier may have malfunctioned. Replace the servo amplifier.	
3. There is a problem with the surrounding environment.	Check the noise, ambient temperature, and other conditions, and implement appropriate countermeasures for the cause. If there is noise, take countermeasures to reduce the noise. Refer to "Noise reduction techniques" in the following manuals.  MR-J5 User's Manual (Hardware)  MR-J5D User's Manual (Hardware)	

[AL. 017.9_Board error 8]

Cause	Check/action method	Model
1. There is a problem with the surrounding environment.	Check the noise, ambient temperature, and other conditions, and implement appropriate countermeasures for the cause. If there is noise, take countermeasures to reduce the noise. Refer to "Noise reduction techniques" in the following manuals.  MR-J5 User's Manual (Hardware)  MR-J5D User's Manual (Hardware)	[G] [B]
2. The servo amplifier has malfunctioned.	Replace the servo amplifier.	



[AL. 017.A_Board error 9]

Cause	Check/action method	Model
1. A push button is faulty.	After checking the conditions of the push buttons, cycle the power, then check the repeatability. If the failure continues, the servo amplifier may have malfunctioned. Replace the servo amplifier.	[A]
2. There is a problem with the surrounding environment.	Check the noise, ambient temperature, and other conditions, and implement appropriate countermeasures for the cause. If there is noise, take countermeasures to reduce the noise. Refer to "Noise reduction techniques" in the following manuals.  MR-J5 User's Manual (Hardware)	

[AL. 019_Memory error 3]

- The internal part of the servo amplifier (Flash-ROM) has malfunctioned.

[AL. 019.1_Flash-ROM error 1]

Cause	Check/action method	Model
1. The Flash-ROM has malfunctioned.	Noise from the power supply may have caused the failure. Disconnect all cables except for those for the control circuit power supply, then check the repeatability. If the failure continues, replace the servo amplifier.	[G] [B] [A]
2. There is a problem with the surrounding environment.	Check the noise, ambient temperature, and other conditions, and implement appropriate countermeasures for the cause. If there is noise, take countermeasures to reduce the noise. Refer to "Noise reduction techniques" in the following manuals.  MR-J5 User's Manual (Hardware)  MR-J5D User's Manual (Hardware)	
3. A firmware installation failed.	Install the firmware again.	

[AL. 019.2_Flash-ROM error 2]

 Page 43 [AL. 019.1_Flash-ROM error 1]

[AL. 019.3_Flash-ROM error 3]

 Page 43 [AL. 019.1_Flash-ROM error 1]

[AL. 019.6_Flash-ROM error 6]

 Page 43 [AL. 019.1_Flash-ROM error 1]

[AL. 01A_Servo motor combination error]

- The combination of the servo amplifier and servo motor is incorrect.
- The combination of the servo amplifier and servo motor constant file is incorrect.

[AL. 01A.1_Servo motor combination error 1]

Cause	Check/action method	Model
1. The servo amplifier and the servo motor have been connected incorrectly.	Refer to "Servo amplifier/motor combinations" in the following manual. <input type="checkbox"/> MR-J5 User's Manual (Hardware) Refer to "Combination with drive units and servo motors" in the following manual. <input type="checkbox"/> MR-J5D User's Manual (Hardware)	[G] [B] [A]
2. A rotary servo motor that does not support the firmware version of the servo amplifier is connected to the servo amplifier.	Referring to "Servo amplifier/motor combinations" in the following manual, check if there are any restrictions on the firmware version. <input type="checkbox"/> MR-J5 User's Manual (Hardware) Refer to "Combination with drive units and servo motors" in the following manual. <input type="checkbox"/> MR-J5D User's Manual (Hardware)	
3. A servo motor whose manufacture date is old has been connected.	Refer to "Servo amplifier/motor combinations" in the following manual. <input type="checkbox"/> MR-J5 User's Manual (Hardware) Refer to "Combination with drive units and servo motors" in the following manual. <input type="checkbox"/> MR-J5D User's Manual (Hardware)	
4. [Pr. PA17 Servo motor series setting] and [Pr. PA18 Servo motor type setting] were not set based on the servo motor to be used.	Check if [Pr. PA17] and [Pr. PA18] have been set correctly.	
5. The encoder has malfunctioned.	Replace the servo motor.	

[AL. 01A.2_Servo motor control mode combination error]

Cause	Check/action method	Model
1. The combination of the servo motor being used and the setting of [Pr. PA01.1 Operation mode selection] is not appropriate.	Check the [Pr. PA01.1] setting.	[G] [B] [A]
2. In the fully closed loop control mode, the servo motor-side encoder and the load-side encoder are incorrectly connected to the servo amplifier.	Refer to "USING A FULLY CLOSED LOOP SYSTEM" in the following manuals. <input type="checkbox"/> MR-J5 User's Manual (Hardware) <input type="checkbox"/> MR-J5D User's Manual (Hardware)	
3. In the scale measurement mode, the servo motor-side encoder and the load-side encoder are incorrectly connected to the servo amplifier.	Refer to "Scale measurement function" in the following manual. <input type="checkbox"/> MR-J5 User's Manual (Function) When using the A/B/Z-phase differential output encoder, check if [Pr. PC27.5 Scale measurement encoder selection] has been set correctly.	[G] [B]

[AL. 01A.3_Control mode/load-side encoder combination error]

Cause	Check/action method	Model
1. In the fully closed loop control mode, the servo motor-side encoder and the load-side encoder are incorrectly connected to the servo amplifier.	Refer to "USING A FULLY CLOSED LOOP SYSTEM" in the following manuals. <input type="checkbox"/> MR-J5 User's Manual (Hardware) <input type="checkbox"/> MR-J5D User's Manual (Hardware)	[G] [B] [A]
2. In the scale measurement mode, the servo motor-side encoder and the load-side encoder are incorrectly connected to the servo amplifier.	Refer to "Scale measurement function" in the following manual. <input type="checkbox"/> MR-J5 User's Manual (Function) When using the A/B/Z-phase differential output encoder, check if [Pr. PC27.5 Scale measurement encoder selection] has been set correctly.	[G] [B]
3. Values of the servo parameters for manufacturer setting have been changed.	Set the servo parameters for manufacturer setting to the initial values.	



[AL. 01A.4_Servo motor combination error 2]

Cause	Check/action method	Model
1. The servo amplifier has malfunctioned.	Replace the servo amplifier.	[G] [B] [A]

[AL. 01A.5_Servo motor combination error 3]

Cause	Check/action method	Model
1. The servo motor that was connected at the startup of the absolute position detection system was changed to a different servo motor.	Check if a servo motor other than the one that was connected at the startup of the absolute position detection system is connected. If a different servo motor is connected, reconnect to the servo motor that was connected at the startup of the absolute position detection system.	[G] [B] [A]
2. At occurrence of [AL. 025 Absolute position erased], the power was cycled without leaving the servo motor for 5 s.	After changing the setting value of [Pr. PA03.1 Servo motor replacement preparation] to "1" (enabled), cycle the power and then deactivate [AL. 01A Servo motor combination error]. Perform homing again.	
3. The servo motor was replaced.		
4. After a servo amplifier with the factory settings has been connected to a controller for the first time, the fully closed loop control mode and an absolute position detection system were set with the controller, then the servo amplifier was turned on again.		
5. The servo amplifier was replaced with one that has been set as follows: <ul style="list-style-type: none"> • [Pr. PF63.2] has been set to "1" (enabled). • [Pr. PC84] to [Pr. PC91] have been set to values other than "0". 		[B]
6. The servo amplifier has malfunctioned.	Replace the servo amplifier.	[G] [B] [A]
7. The encoder has malfunctioned.	Replace the servo motor.	
8. There is a problem with the surrounding environment.	Check the noise, ambient temperature, and other conditions, and implement appropriate countermeasures for the cause. If there is noise, take countermeasures to reduce the noise. Refer to "Noise reduction techniques" in the following manuals. <ul style="list-style-type: none"> 📖 MR-J5 User's Manual (Hardware) 📖 MR-J5D User's Manual (Hardware) 	

[AL. 01A.6_Servo motor combination error 4]

Cause	Check/action method	Model
1. The scale measurement encoder that was connected at the startup of the absolute position detection system was changed to a different scale measurement.	Check if a scale measurement encoder other than the one that was connected at the startup of the absolute position detection system is connected. If a different scale measurement encoder is connected, reconnect to the scale measurement encoder that was connected at the startup of the absolute position detection system. After changing the setting value of [Pr. PA03.2 Scale measurement encoder replacement preparation] to "1", cycle the power and then deactivate [AL. 01A Servo motor combination error].	[G] [B] [A]
2. At occurrence of [AL. 025 Absolute position erased], the power was cycled without leaving the servo motor for 5 s.		
3. The scale measurement encoder was replaced.		
4. The servo amplifier was replaced with one that has been set as follows: <ul style="list-style-type: none"> • [Pr. PF63.2] has been set to "1" (enabled). • [Pr. PC92] to [Pr. PC95] have been set to values other than "0". 		[B]
5. The servo amplifier has malfunctioned.	Replace the servo amplifier.	[G] [B] [A]
6. The scale measurement encoder has malfunctioned.	Replace the scale measurement encoder.	
7. There is a problem with the surrounding environment.	Check the noise, ambient temperature, and other conditions, and implement appropriate countermeasures for the cause. If there is noise, take countermeasures to reduce the noise. Refer to "Noise reduction techniques" in the following manuals. <ul style="list-style-type: none">  MR-J5 User's Manual (Hardware)  MR-J5D User's Manual (Hardware) 	

[AL. 01B_Protection coordination error]

- An alarm occurred in the converter unit or another MR-J5D_ connected with a protection coordination cable during servo-on.

[AL. 01B.1_Protection coordination error 1]

Cause	Check/action method	Model
1. The protection coordination cable is not connected correctly.	Connect the protection coordination cable correctly. Refer to "Example power circuit connections" in the following manual. ☞MR-J5D User's Manual (Hardware)	[G]
2. An alarm occurred in the converter unit during servo-on.	Check the alarm occurred in the converter unit, and take corrective action in accordance with "CONVERTER UNIT TROUBLESHOOTING" in the following manual. ☞MR-CV Power Regeneration Converter Unit User's Manual	
3. An alarm occurred in another MR-J5D_ connected with a protection coordination cable during servo-on.	Check the alarm occurred in the servo amplifier that is causing the problem, and take corrective action.	



[AL. 01B.4_Protection coordination error 2]

Cause	Check/action method	Model
1. The protection coordination cable is not connected correctly.	Connect the protection coordination cable correctly. Refer to "Example power circuit connections" in the following manual. ☞MR-J5D User's Manual (Hardware)	[G]
2. The ready-on command was input while an alarm was occurring in the converter unit.	Check the alarm occurred in the converter unit, and take corrective action in accordance with "CONVERTER UNIT TROUBLESHOOTING" in the following manual. ☞MR-CV Power Regeneration Converter Unit User's Manual	
3. The ready-on command was input while an alarm was occurring in another MR-J5D_ connected with a protection coordination cable.	Check the trouble on the device that is causing the problem, and follow the procedure.	
4. The ready-on command was not input to another MR-J5D_ connected with a protection coordination cable.	Input the ready-on command at the same time to all MR-J5D_ connected with a protection coordination cable.	



[AL. 01E_ Encoder initial communication error 2]

- The encoder has malfunctioned.

[AL. 01E.1_ Encoder malfunction]

Cause	Check/action method	Model
1. The encoder has malfunctioned.	Replace the servo motor.	[G] [B] [A]
2. There is a problem with the surrounding environment.	Check the noise, ambient temperature, and other conditions, and implement appropriate countermeasures for the cause. If there is noise, take countermeasures to reduce the noise. Refer to "Noise reduction techniques" in the following manuals.  MR-J5 User's Manual (Hardware)  MR-J5D User's Manual (Hardware)	

[AL. 01E.2_ Load-side encoder malfunction]

Cause	Check/action method	Model
1. The load-side encoder has malfunctioned.	Replace the load-side encoder.	[G] [B] [A]
2. There is a problem with the surrounding environment.	Check the noise, ambient temperature, and other conditions, and implement appropriate countermeasures for the cause. If there is noise, take countermeasures to reduce the noise. Refer to "Noise reduction techniques" in the following manuals.  MR-J5 User's Manual (Hardware)  MR-J5D User's Manual (Hardware)	

[AL. 01F_ Encoder initial communication error 3]

- The connected encoder is not compatible with the servo amplifier.

[AL. 01F.1_Incompatible encoder]

Cause	Check/action method	Model
1. An incompatible servo motor or an incompatible linear encoder was connected to the servo amplifier.	Refer to "Servo amplifier/motor combinations" in the following manual. <input type="checkbox"/> MR-J5 User's Manual (Hardware) Refer to "Combination with drive units and servo motors" in the following manual. <input type="checkbox"/> MR-J5D User's Manual (Hardware) Refer to "Compatible encoder list" in the following manual. <input type="checkbox"/> MR-J5 Partner's Encoder User's Manual	[G] [B] [A]
2. The firmware version of the servo amplifier does not support the servo motor or linear encoder.	Refer to "Servo amplifier/motor combinations" in the following manual. <input type="checkbox"/> MR-J5 User's Manual (Hardware) Refer to "Combination with drive units and servo motors" in the following manual. <input type="checkbox"/> MR-J5D User's Manual (Hardware) Refer to "Compatible encoder list" in the following manual. <input type="checkbox"/> MR-J5 Partner's Encoder User's Manual	
3. The encoder or linear encoder has malfunctioned.	Replace the servo motor or linear encoder.	

[AL. 01F.2_Incompatible load-side encoder]

Cause	Check/action method	Model
1. A load-side encoder incompatible with the servo amplifier was connected.	Check the model name of the load-side encoder.	[G] [B] [A]
2. The firmware version of the servo amplifier does not support the load-side encoder.	Refer to "Compatible encoder list" in the following manual. <input type="checkbox"/> MR-J5 Partner's Encoder User's Manual	
3. The load-side encoder has malfunctioned.	Replace the load-side encoder, then check the repeatability. If the error does not repeat, replace the load-side encoder.	

[AL. 020_ Encoder normal communication error 1]

- There is a communication error between the encoder and servo amplifier.

[AL. 020.1_ Encoder normal communication - Receive data error 1]

Cause	Check/action method	Model
1. There is a problem with the encoder cable.	Check if the encoder cable has been disconnected or has shorted. If there is a problem with the cable, repair or replace the cable. If an A/B/Z-phase differential output type encoder is being used, check if the encoder is wired correctly. Refer to "A/B/Z-phase differential output type encoder" in the following manual. MR-J5 Partner's Encoder User's Manual	[G] [B] [A]
2. The external conductor of the encoder cable is not connected to the ground plate of the connector.	Check if the external conductor of the encoder cable is connected to the ground plate of the connector. Refer to "Shield procedure of CN2, CN2A, CN2B, and CN2C side connectors" in the following manual. Rotary Servo Motor User's Manual (For MR-J5)	
3. The servo parameter settings for the communication method are incorrect.	Set the servo parameter correctly according to the encoder cable communication method (two-wire type/four-wire type). [G] [B]: [Pr. PC04.3 Encoder cable communication method selection] [A]: [Pr. PC22.3 Encoder cable communication method selection]	
4. The servo amplifier has malfunctioned.	Replace the servo amplifier.	
5. The encoder has malfunctioned.	Replace the servo motor.	
6. There is a problem with the surrounding environment.	Check the noise, ambient temperature, vibration, and other conditions, and implement appropriate countermeasures for the cause. If there is noise, take countermeasures to reduce the noise. Refer to "Noise reduction techniques" in the following manuals. MR-J5 User's Manual (Hardware) MR-J5D User's Manual (Hardware) If vibration is the cause, check for any loose connection of connectors due to abnormal vibration through components such as an encoder connector of the servo amplifier or servo motor.	

[AL. 020.2_ Encoder normal communication - Receive data error 2]

Page 50 [AL. 020.1_ Encoder normal communication - Receive data error 1]



[AL. 020.3_ Encoder normal communication - Receive data error 3]

Cause	Check/action method	Model
1. The Z-phase signal cannot be detected despite being on. This does not apply to multi-axis servo amplifiers.	Check if the Z-phase pulse signals (PZ and PZR) of the encoder cable have been disconnected or have shorted. Refer to the specifications provided by the encoder manufacturer or "A/B/Z-phase differential output type encoder" in the following manual. MR-J5 Partner's Encoder User's Manual	[G] [B] [A]
2. There is a problem with the encoder cable.	Page 50 [AL. 020.1_ Encoder normal communication - Receive data error 1]	
3. The external conductor of the encoder cable is not connected to the ground plate of the connector.		
4. The servo parameter settings for the communication method are incorrect.		
5. The servo amplifier has malfunctioned.		
6. The encoder has malfunctioned.		
7. There is a problem with the surrounding environment.		



[AL. 020.4_ Manufacturer setting error]

This is for manufacturer setting.

[AL. 020.5_Encoder normal communication - Transmission data error 1]

Cause	Check/action method	Model
1. If an A/B/Z-phase differential output type encoder is being used, the wiring of the encoder is incorrect.	Check if the A/B-phase pulse signals (PA, PAR, PB, and PBR) of the encoder cable have been disconnected or have shorted. Refer to the specifications provided by the encoder manufacturer or "A/B/Z-phase differential output type encoder" in the following manual.  MR-J5 Partner's Encoder User's Manual	[G] [B] [A]
2. There is a problem with the encoder cable.	 Page 50 [AL. 020.1_Encoder normal communication - Receive data error 1]	
3. The external conductor of the encoder cable is not connected to the ground plate of the connector.		
4. If an A/B/Z-phase differential output type encoder is being used, the servo parameter settings are incorrect.		
5. The servo amplifier has malfunctioned.		
6. The encoder has malfunctioned.		
7. There is a problem with the surrounding environment.		

[AL. 020.6_Encoder normal communication - Transmission data error 2]

Cause	Check/action method	Model
1. If an A/B/Z-phase differential output type encoder is being used, the wiring of the encoder is incorrect.	Check if the Z-phase pulse signals (PZ and PZR) of the encoder cable have been disconnected or have shorted. Refer to the specifications provided by the encoder manufacturer or "A/B/Z-phase differential output type encoder" in the following manual.  MR-J5 Partner's Encoder User's Manual	[G] [B] [A]
2. There is a problem with the encoder cable.	 Page 50 [AL. 020.1_Encoder normal communication - Receive data error 1]	
3. The external conductor of the encoder cable is not connected to the ground plate of the connector.		
4. If an A/B/Z-phase differential output type encoder is being used, the servo parameter settings are incorrect.		
5. The servo amplifier has malfunctioned.		
6. The encoder has malfunctioned.		
7. There is a problem with the surrounding environment.		

[AL. 020.7_Encoder normal communication - Transmission data error 3]

 Page 50 [AL. 020.1_Encoder normal communication - Receive data error 1]

[AL. 020.C_Encoder communication protocol error 1]

 Page 50 [AL. 020.1_Encoder normal communication - Receive data error 1]

[AL. 020.D_Encoder communication protocol error 2]

 Page 50 [AL. 020.1_Encoder normal communication - Receive data error 1]

[AL. 021_ Encoder normal communication error 2]

- The encoder detected an error signal.

[AL. 021.1_ Encoder data error 1]

Cause	Check/action method	Model
1. An excessive speed or acceleration was detected due to an oscillation or other factors.	Decrease the control gain, then check the repeatability. If the error does not repeat, use the encoder with a lower gain.	[G] [B] [A]
2. The external conductor of the encoder cable is not connected to the ground plate of the connector.	Check if the external conductor of the encoder cable is connected to the ground plate of the connector. Refer to "Shield procedure of CN2, CN2A, CN2B, and CN2C side connectors" in the following manual. Rotary Servo Motor User's Manual (For MR-J5)	
3. The encoder power supply voltage dropped considerably in the encoder cable wiring.	When cables are fabricated by the customer, check if wires with specifications equivalent to the recommended wires are used for the encoder cable. Use the wires with specifications equivalent to the recommended wires if they are not used. Refer to "Wires for option cables" in the following manual. Rotary Servo Motor User's Manual (For MR-J5)	
4. There is a problem with the encoder cable.	Check if the encoder cable has been disconnected or has shorted. If there is a problem with the cable, repair or replace the cable.	
5. The encoder has malfunctioned.	Replace the servo motor.	
6. There is a problem with the surrounding environment.	Check the noise, ambient temperature, external magnetic field, and other conditions, and implement appropriate countermeasures for the cause. MR-J5 User's Manual (Hardware) MR-J5D User's Manual (Hardware)	



[AL. 021.2_ Encoder data update error]

Cause	Check/action method	Model
1. The encoder has malfunctioned.	Replace the servo motor.	[G] [B] [A]
2. The external conductor of the encoder cable is not connected to the ground plate of the connector.	Check if the external conductor of the encoder cable is connected to the ground plate of the connector. Refer to "Shield procedure of CN2, CN2A, CN2B, and CN2C side connectors" in the following manual. Rotary Servo Motor User's Manual (For MR-J5)	
3. There is a problem with the surrounding environment.	Check the noise, ambient temperature, and other conditions, and implement appropriate countermeasures for the cause. If there is noise, take countermeasures to reduce the noise. Refer to "Noise reduction techniques" in the following manuals. MR-J5 User's Manual (Hardware) MR-J5D User's Manual (Hardware)	

[AL. 021.3_ Encoder data waveform error]

Page 52 [AL. 021.2_ Encoder data update error]

[AL. 021.4_No encoder signal]

Cause	Check/action method	Model
1. A signal of the encoder has not been input.	Check if the encoder cable is wired correctly.	[G]
2. The external conductor of the encoder cable is not connected to the ground plate of the connector.	Check if the external conductor of the encoder cable is connected to the ground plate of the connector. Refer to "Shield procedure of CN2, CN2A, CN2B, and CN2C side connectors" in the following manual.  Rotary Servo Motor User's Manual (For MR-J5)	[B] [A]
3. There is a problem with the surrounding environment.	Check the noise, ambient temperature, and other conditions, and implement appropriate countermeasures for the cause. If there is noise, take countermeasures to reduce the noise. Refer to "Noise reduction techniques" in the following manuals.  MR-J5 User's Manual (Hardware)  MR-J5D User's Manual (Hardware)	

[AL. 021.5_Encoder hardware error 1]

 Page 52 [AL. 021.2_Encoder data update error]

[AL. 021.6_Encoder hardware error 2]

 Page 52 [AL. 021.2_Encoder data update error]

[AL. 024_Main circuit error]

- The servo motor power cable has a ground fault.
- The servo motor has a ground fault.

[AL. 024.1_Ground fault detected via hardware detection circuit]

Cause	Check/action method	Model
1. The servo motor power cable has a ground fault or has shorted.	Check if the servo motor power cable has a ground fault. If the servo motor power cable has a ground fault, correct the wiring. Incorrect wiring of the U/V/W cable and grounding cable between the servo amplifier and servo motor may cause a ground fault. Check the wiring. Check if the servo motor power cable has shorted. If the servo motor power cable has shorted, replace the servo motor power cable.	[G] [B] [A]
2. The servo motor has a ground fault.	After disconnecting the servo motor power cables on the servo motor side, check the insulation between phases (U/V/W/⊕). If the servo motor has a ground fault or has shorted, replace the servo motor.	
3. The main circuit power supply cable and servo motor power cable have shorted.	After shutting off the power, make sure that the main circuit power cable and the motor power cable are not in contact with each other. If the cables are contacting, correct the wiring.	
4. The servo amplifier has malfunctioned.	Check that this alarm occurs as the servo motor power cables (U/V/W) are disconnected. If the alarm occurs, replace the servo amplifier.	
5. The wiring of the regenerative resistor (regenerative option) is incorrect.	Check if the regenerative resistor (regenerative option) is wired correctly. If the regenerative resistor (regenerative option) is wired incorrectly, correct the wiring.	
6. The regenerative resistor (regenerative option) and the servo amplifier are connected in a wrong combination.	Check if the combination of the regenerative resistor (regenerative option) and the servo amplifier is correct as specified. Refer to "Regenerative option" in the following manual. 📖 MR-J5 User's Manual (Hardware)	
7. There is a problem with the surrounding environment.	Check the noise, ambient temperature, and other conditions, and implement appropriate countermeasures for the cause. If there is noise, take countermeasures to reduce the noise. Refer to "Noise reduction techniques" in the following manuals. 📖 MR-J5 User's Manual (Hardware) 📖 MR-J5D User's Manual (Hardware)	

[AL. 024.2_Ground fault detected via software detection processing]

Cause	Check/action method	Model
1. The servo motor power cable has a ground fault or has shorted.	Check if the servo motor power cable has a ground fault. If the servo motor power cable has a ground fault, correct the wiring. Incorrect wiring of the U/V/W cable and grounding cable between the servo amplifier and servo motor may cause a ground fault. Check the wiring. Check if the servo motor power cable has shorted. If the servo motor power cable has shorted, replace the servo motor power cable.	[G] [B] [A]
2. The servo motor has a ground fault.	After disconnecting the servo motor power cables on the servo motor side, check the insulation between phases (U/V/W/⊕). If the servo motor has a ground fault or has shorted, replace the servo motor.	
3. The main circuit power supply cable and servo motor power cable have shorted.	After shutting off the power, make sure that the main circuit power cable and the motor power cable are not in contact with each other. If the cables are contacting, correct the wiring.	
4. The servo amplifier has malfunctioned.	Check that this alarm occurs as the servo motor power cables (U/V/W) are disconnected. If the alarm occurs, replace the servo amplifier.	
5. There is a problem with the surrounding environment.	Check the noise, ambient temperature, and other conditions, and implement appropriate countermeasures for the cause. If there is noise, take countermeasures to reduce the noise. Refer to "Noise reduction techniques" in the following manuals. 📖 MR-J5 User's Manual (Hardware) 📖 MR-J5D User's Manual (Hardware)	

[AL. 025_Absolute position erased]

- The absolute position data has an error.
- Power was switched on for the first time in the absolute position detection system.
- Power was switched on for the first time after the scale measurement encoder was set for the absolute position detection system.
- The servo amplifier was powered on when the battery was degraded or disconnected.

[AL. 025.1_Servo motor encoder absolute position erased]

Cause	Check/action method	Model
1. Power was switched on for the first time in the absolute position detection system.	If the power was switched on for the first time after the absolute position detection system is set, check that the battery is mounted correctly before homing. When using a Mitsubishi Electric servo motor equipped with a batteryless absolute position encoder, allow the alarm to occur for 5 s, then cycle the power. Perform homing.	[G] [B] [A]
2. The Mitsubishi Electric servo motor equipped with a batteryless absolute position encoder that was connected to the absolute position detection system at startup was changed to another servo motor.	Connect the servo motor that was connected at the startup of the absolute position detection system. Start up the absolute position detection system again.	
3. After the control circuit power supply was shut off, the battery was removed in either of the following situations: • When using an MR-BAT6V1SET(-A) battery or MR-BT6VCASE battery case, CN4 of the servo amplifier was disconnected with the control circuit power supply off.	If the battery was disconnected as described in the left column, check that the battery is mounted correctly before homing.	
4. The power was shut off in either of the following situations: • When using an MR-BAT6V1SET(-A) or MR-BT6VCASE, the power was shut off with the battery disconnected from CN4.	If the power supply was shut off as described in the left column, check that the battery is mounted correctly before homing. When MR-BAT6V1SET(-A) or MR-BT6VCASE is used, see 5.	
5. The battery voltage is too low. The battery is exhausted.	Check the battery voltage with a tester. If the voltage is lower than 3 V DC, replace the battery, then execute homing.	
6. The voltage dropped considerably in the encoder cable wired to the battery.	Check if the recommended wires are being used for the encoder cable. If the recommended wires are not being used, use the recommended wires, then execute homing. Refer to "Wires for option cables" in the following manual. ☐ Rotary Servo Motor User's Manual (For MR-J5)	
7. There is a problem with the battery cable.	Check for a loose connection with a tester. If there is a loose connection, use a recommended cable, then execute homing.	
8. There is a loose connection of the encoder cable on the servo motor side.	Check for a loose connection with a tester. Measure the voltage on the servo motor side. If there is a loose connection, repair or replace the encoder cable, then execute homing.	
9. When using a direct drive motor, the absolute position storage unit is not connected.	If the absolute position storage unit has not been connected correctly, connect it correctly, then execute homing. Refer to "Combinations of encoder cables" in the following manual. ☐ Direct Drive Motor User's Manual	
10. There is a problem with the encoder cable.	If there is a problem with the encoder cable, replace or repair the cable, then execute homing.	
11. When the Mitsubishi Electric servo motor equipped with a batteryless absolute position encoder was used, an external force rotated the servo motor shaft at a high speed at power failure.	Make sure that the servo motor shaft will not be rotated by an external force at a high speed. After removing the cause, execute homing, then turn the servo motor shaft at least 180 degrees.	
12. There is a problem with the surrounding environment when using the Mitsubishi Electric servo motor equipped with a batteryless absolute position encoder.	Check the noise, ambient temperature, and other conditions, and implement appropriate countermeasures for the cause. If there is noise, take countermeasures to reduce the noise. Refer to "Noise reduction techniques" in the following manuals. ☐ MR-J5 User's Manual (Hardware) ☐ MR-J5D User's Manual (Hardware) After removing the cause, execute homing, then turn the servo motor shaft at least 180 degrees.	
13. The servo amplifier has malfunctioned.	Replace the servo amplifier.	
14. The encoder has malfunctioned.	Replace the servo motor.	

[AL. 025.2_Scale measurement encoder - Absolute position erased]

Cause	Check/action method	Model
<p>1. Power was switched on for the first time after the scale measurement encoder was set for the absolute position detection system.</p>	<p>If the power was switched on for the first time, check that the battery is mounted correctly before homing.</p> <p>When using a Mitsubishi Electric servo motor equipped with a batteryless absolute position encoder, allow the alarm to occur for 5 s, then cycle the power. Perform homing.</p>	[G] [B]
<p>2. The Mitsubishi Electric servo motor equipped with a batteryless absolute position encoder that was connected to the absolute position detection system at startup was changed to another servo motor or encoder.</p>	<p>Connect the servo motor that was connected at the startup of the absolute position detection system. Start up the absolute position detection system again.</p>	
<p>3. After the control circuit power supply was shut off, the battery was removed in either of the following situations:</p> <ul style="list-style-type: none"> • When using an MR-BAT6V1SET(-A) battery or MR-BT6VCASE battery case, CN4 of the servo amplifier was disconnected with the control circuit power supply off. 	<p>If the battery was disconnected as described in the left column, check that the battery is mounted correctly before homing.</p>	
<p>4. The power was shut off in either of the following situations:</p> <ul style="list-style-type: none"> • When using an MR-BAT6V1SET(-A) or MR-BT6VCASE, the power was shut off with the battery disconnected from CN4. 	<p>If the power supply was shut off as described in the left column, check that the battery is mounted correctly before homing.</p>	
<p>5. The battery voltage is too low. The battery is exhausted.</p>	<p>Check the battery voltage with a tester. If the voltage is lower than 3 V DC, replace the battery.</p>	
<p>6. The voltage dropped considerably in the encoder cable wired to the battery.</p>	<p>Check if the recommended wires are being used for the encoder cable. Refer to "Wires for option cables" in the following manual.</p> <ul style="list-style-type: none"> ☐ Rotary Servo Motor User's Manual (For MR-J5) <p>Refer to "WIRING OPTION" in the following manual.</p> <ul style="list-style-type: none"> ☐ Direct Drive Motor User's Manual ☐ "OPTION CABLES/CONNECTOR SETS" in the following manual. ☐ MR-J5 Partner's Encoder User's Manual 	
<p>7. There is a problem with the battery cable.</p>	<p>Check for a loose connection with a tester.</p> <p>If there is a loose connection, use a recommended cable.</p>	
<p>8. There is a loose connection of the encoder cable on the scale measurement encoder-side.</p>	<p>Check for a loose connection with a tester. Measure the voltage on the scale measurement encoder-side.</p> <p>If there is a loose connection, repair or replace the encoder cable.</p>	
<p>9. When the Mitsubishi Electric servo motor equipped with a batteryless absolute position encoder was used, an external force rotated the servo motor shaft at a high speed at power failure.</p>	<p>Make sure that the servo motor shaft will not be rotated by an external force at a high speed.</p> <p>After removing the cause and clearing the alarm, perform homing, then turn the servo motor shaft at least 180 degrees.</p>	
<p>10. There is a problem with the surrounding environment when using the Mitsubishi Electric servo motor equipped with a batteryless absolute position encoder.</p>	<p>Check the noise, ambient temperature, and other conditions, and implement appropriate countermeasures for the cause.</p> <p>If there is noise, take countermeasures to reduce the noise.</p> <p>Refer to "Noise reduction techniques" in the following manuals.</p> <ul style="list-style-type: none"> ☐ MR-J5 User's Manual (Hardware) ☐ MR-J5D User's Manual (Hardware) <p>After removing the cause and clearing the alarm, perform homing, then turn the servo motor shaft at least 180 degrees.</p>	
<p>11. The servo amplifier has malfunctioned.</p>	<p>Replace the servo amplifier.</p>	
<p>12. The scale measurement encoder has malfunctioned.</p>	<p>Replace the scale measurement encoder.</p>	

[AL. 027_Initial magnetic pole detection error]

- The initial magnetic pole detection cannot be performed properly.

[AL. 027.1_Initial magnetic pole detection - Abnormal termination]

Cause	Check/action method	Model
1. A moving part collided against the machine.	If the moving part collides, move the start position of the magnetic pole detection.	[G] [B] [A]
2. The wiring of the servo motor power cable is incorrect.	Check the motor power cable for abnormality. Refer to "Power supply cable wiring diagrams" in the Linear Servo Motor User's Manual. Refer to "Direct drive motor power cable wiring diagram" in the following manual. Direct Drive Motor User's Manual	
3. The linear encoder resolution setting differs from the setting value.	Check the settings of [Pr. PL02 Linear encoder resolution setting - Numerator] and [Pr. PL03 Linear encoder resolution setting - Denominator].	
4. The mounting direction of the linear encoder is incorrect.	Check the polarities of the linear encoder and the linear servo motor. If the mounting direction is incorrect, mount the encoder correctly. Change the setting of "Encoder pulse count polarity selection" as required. [G] [B]: [Pr. PC27.0 Encoder pulse count polarity selection] [A]: [Pr. PC45.0 Encoder pulse count polarity selection] Refer to "Setting of linear encoder direction and linear servo motor direction" in the following manual. MR-J5 User's Manual (Hardware)	
5. The direct current exciting voltage level is too low.	<ul style="list-style-type: none"> • When in position detection method Check if the travel distance in the magnetic pole detection is small. If the travel distance is small, set a larger value in [Pr. PL09 Magnetic pole detection voltage level]. <ul style="list-style-type: none"> • When in minute position detection method Check if the travel distance in the magnetic pole detection is too large, or if a vibration is occurring. If the travel distance is too large or a vibration is occurring, review the settings of [Pr. PL17.0 Response selection] and [Pr. PL17.1 Load to motor mass ratio/load to motor inertia ratio selection]. Refer to "Magnetic pole detection" in the following manual. MR-J5 User's Manual (Hardware)	

[AL. 027.2_Initial magnetic pole detection - Time out error]

Cause	Check/action method	Model
1. Servo-on was turned on while the primary side of the linear servo motor or the rotor of the direct drive motor was not stopped.	Stop the linear servo motor or the direct drive motor, then turn on the servo-on again.	[G] [B] [A]
2. Only one of the limit switches is on during magnetic pole detection.	Check the limit switches and remove the cause. Move the start position of the magnetic pole detection.	
3. The direct current exciting voltage level is too low at the time of the initial magnetic pole detection.	<ul style="list-style-type: none"> • When in position detection method Check if the travel distance in the magnetic pole detection is small. If the travel distance is small, set a larger value in [Pr. PL09 Magnetic pole detection voltage level].	

[AL. 027.3_Initial magnetic pole detection - Limit switch error]

Cause	Check/action method	Model
1. In the magnetic pole detection, both limit switches are turned off.	Check the limit switch status. If both of the limit switches are turned off, turn on the limit switches. When using a direct drive motor, see also 2.	[G] [B] [A]
2. When using a direct drive motor in a system where the motor rotates one revolution or more, the following stroke limit signals are not disabled with a servo parameter. [G]: LSP and LSN (FLS and RLS from the controller) [B]: FLS and RLS [A]: LSP and LSN	Check the setting of [Pr. PL08.2 Magnetic pole detection - Stroke limit enabled/disabled selection]	
3. The settings of the magnetic pole detection are incorrect.	Check the settings of the servo parameter and other relevant areas. Refer to "Magnetic pole detection" in the following manual.  MR-J5 User's Manual (Hardware)	

[AL. 027.4_Initial magnetic pole detection - Estimation error]

 Page 58 [AL. 027.1_Initial magnetic pole detection - Abnormal termination]

[AL. 027.5_Initial magnetic pole detection - Speed deviation error]

 Page 58 [AL. 027.1_Initial magnetic pole detection - Abnormal termination]

[AL. 027.6_Initial magnetic pole detection - Position deviation error]

 Page 58 [AL. 027.1_Initial magnetic pole detection - Abnormal termination]

[AL. 027.7_Initial magnetic pole detection - Current error]

 Page 58 [AL. 027.1_Initial magnetic pole detection - Abnormal termination]

[AL. 028_Linear encoder error 2]

- There is a problem with the operating environment of the linear encoder.

[AL. 028.1_Linear encoder environmental error]

Cause	Check/action method	Model
1. The ambient temperature of the linear encoder is outside of specifications.	Check the ambient temperature and the specifications of the linear encoder.	[G] [B] [A]
2. The signal level of the linear encoder dropped.	Check the mounting condition of the linear encoder.	
3. A linear encoder alarm was detected.	Refer to "DETAILED EXPLANATION OF [AL. 028 LINEAR ENCODER ERROR 2]" in the following manual.  MR-J5 Partner's Encoder User's Manual	





[AL. 028.2_Load-side linear encoder environmental error]

 Page 60 [AL. 028.1_Linear encoder environmental error]

[AL. 02A_Linear encoder error 1]

- An error of the linear encoder was detected. The content of the errors varies depending on each encoder manufacturer.

[AL. 02A.1_Linear encoder error 1-1]

Cause	Check/action method	Model
1. There is a problem with the way that the linear encoder and the head are mounted.	Adjust the positions of the linear encoder and the head.	[G] [B] [A]
2. The external conductor of the encoder cable is not connected to the ground plate of the connector.	Check if the external conductor of the encoder cable is connected to the ground plate of the connector. Refer to "Shield procedure of CN2, CN2A, CN2B, and CN2C side connectors" in the following manual.  Rotary Servo Motor User's Manual (For MR-J5)	
3. There is a problem with the surrounding environment.	Check the noise, ambient temperature, and other conditions, and implement appropriate countermeasures for the cause. If there is noise, take countermeasures to reduce the noise. Refer to "Noise reduction techniques" in the following manuals.  MR-J5 User's Manual (Hardware)  MR-J5D User's Manual (Hardware)	
4. A linear encoder alarm was detected.	Refer to "DETAILED EXPLANATION OF [AL. 02A LINEAR ENCODER ERROR 1]" in the following manual.  MR-J5 Partner's Encoder User's Manual	

[AL. 02A.2_Linear encoder error 1-2]

 Page 61 [AL. 02A.1_Linear encoder error 1-1]

[AL. 02A.3_Linear encoder error 1-3]

 Page 61 [AL. 02A.1_Linear encoder error 1-1]

[AL. 02A.4_Linear encoder error 1-4]

 Page 61 [AL. 02A.1_Linear encoder error 1-1]

[AL. 02A.5_Linear encoder error 1-5]

 Page 61 [AL. 02A.1_Linear encoder error 1-1]

[AL. 02A.6_Linear encoder error 1-6]

 Page 61 [AL. 02A.1_Linear encoder error 1-1]

[AL. 02A.7_Linear encoder error 1-7]

 Page 61 [AL. 02A.1_Linear encoder error 1-1]



[AL. 02A.8_Linear encoder error 1-8]

 Page 61 [AL. 02A.1_Linear encoder error 1-1]



[AL. 02B_ Encoder counter error]

- There is an error in the data created by the encoder.

[AL. 02B.1_ Encoder counter error 1]

Cause	Check/action method	Model
1. There is a problem with the encoder cable.	Check if the encoder cable has been disconnected or has shorted. If there is a problem with the encoder cable, replace or repair the cable, then execute homing.	[G] [B] [A]
2. The external conductor of the encoder cable is not connected to the ground plate of the connector.	Check if the external conductor of the encoder cable is connected to the ground plate of the connector. If not connected, connect it correctly, then execute homing. Refer to "Shield procedure of CN2, CN2A, CN2B, and CN2C side connectors" in the following manual.  Rotary Servo Motor User's Manual (For MR-J5)	
3. There is a problem with the surrounding environment.	Check the noise, ambient temperature, and other conditions, and implement appropriate countermeasures for the cause. If there is noise, take countermeasures to reduce the noise. Refer to "Noise reduction techniques" in the following manuals.  MR-J5 User's Manual (Hardware)  MR-J5D User's Manual (Hardware) After removing the cause and clearing the alarm, execute homing.	
4. The encoder has malfunctioned.	Replace the direct drive motor.	

[AL. 02B.2_ Encoder counter error 2]

Cause	Check/action method	Model
1. The connection of the servo motor is incorrect.	Check the U/V/W wiring. Refer to "Example power circuit connections" in the following manuals.  MR-J5 User's Manual (Hardware)  MR-J5D User's Manual (Hardware)	[G] [B] [A]
2. Take actions in accordance with the items shown below.  Page 62 [AL. 02B.1_ Encoder counter error 1]		

[AL. 030_Regenerative error]

- The permissible regenerative power of the built-in regenerative resistor or regenerative option was exceeded.
- The regenerative transistor in the servo amplifier has malfunctioned.



[AL. 030.1_Regenerative heat error]

Cause	Check/action method	Model
1. The settings of the regenerative resistor (regenerative option) are incorrect.	Check the regenerative resistor (regenerative option) in use and the setting value of [Pr. PA02 Regenerative option]. Refer to "Regenerative option" in the following manual. ☞MR-J5 User's Manual (Hardware)	[G] [B] [A]
2. The regenerative resistor (regenerative option) is not connected.	When the regenerative option is not used, check if P+ and D are connected correctly. When the regenerative option is used, disconnect the wiring between P+ and D and check if the regenerative option is attached between P+ and C. Refer to "Regenerative option" in the following manual. ☞MR-J5 User's Manual (Hardware)	
3. The regenerative resistor (regenerative option) and the servo amplifier are connected in a wrong combination.	Check if the combination of the regenerative resistor (regenerative option) and the servo amplifier is correct as specified. Refer to "Regenerative option" in the following manual. ☞MR-J5 User's Manual (Hardware)	
4. The power supply voltage is too high.	Check if the voltage of the input power supply exceeds the upper limit of the permissible voltage. If the power supply voltage exceeds the upper limit, reduce the power supply voltage. 200 V class: 264 V AC 400 V class: 528 V AC	
5. The regenerative power is too large.	Check whether the regenerative load ratio exceeds the upper limit value when the alarm occurs. If the alarm is not cleared even after taking the following corrective actions, replace the servo amplifier. <ul style="list-style-type: none"> • Reduce the frequency of positioning. • Set a longer deceleration time constant. • Reduce the load. • Use a regenerative option if it is not being used. • For a multi-axis servo amplifier, ensure that each axis does not decelerate simultaneously. 	
6. The motor power cable (U/V/W cables) has a ground fault. (Increase in the bus voltage between P and N due to a sneak current caused by the ground fault.)	Check if the servo motor power cable has a ground fault. If the servo motor power cable has a ground fault, correct the wiring.	

[AL. 030.2_Regenerative signal error]

Cause	Check/action method	Model
1. The servo amplifier has malfunctioned.	Check if the regenerative resistor (regenerative option) is overheating. If the regenerative resistor is overheating, replace the servo amplifier. Check for any of the following wiring problems when connecting the regenerative option. <ul style="list-style-type: none"> • P+ and C are short-circuited. • The regenerative option is connected between P+ and C when P+ and D are short-circuited. • The combination of servo amplifier and regenerative option is incorrect. (Resistance of the regenerative option is low, etc.) Refer to "Regenerative option" in the following manual. ☞MR-J5 User's Manual (Hardware)	[G] [B] [A]

[AL. 030.3_Regenerative feedback signal error]

Cause	Check/action method	Model
1. The servo amplifier has malfunctioned.	Remove the wire of the regenerative option or built-in regenerative resistor, then check if the alarm occurs at power on. If the alarm occurs, replace the servo amplifier.	[G] [B] [A]
2. There is a problem with the surrounding environment.	Check the noise, ground fault, ambient temperature, and other conditions, then take countermeasures against its cause. If there is noise, take countermeasures to reduce the noise. Refer to "Noise reduction techniques" in the following manuals.  MR-J5 User's Manual (Hardware)  MR-J5D User's Manual (Hardware)	

[AL. 031_Overspeed]

- The servo motor speed exceeded the maximum speed.

1







[AL. 031.1_Servo motor speed error]

Cause	Check/action method	Model
1. The command pulse frequency is too high.	Check the command pulse frequency. If the command pulse frequency exceeds the maximum input pulse frequency, review the operation pattern.	[A]
2. The settings of the electronic gear are incorrect.	Check the setting value of the electronic gear. Refer to "Electronic gear function" in the following manual. □MR-J5 User's Manual (Function)	[G] [B] [A]
3. The command from the controller is excessive.	Check if the command from the controller exceeds the maximum speed. To change the judgment value used to the permissible speed, change the setting of [Pr. PA28.4 Speed range limit selection].	[G] [B]
4. The backlash compensation set in the controller is excessive.	Refer to the manual for the controller being used to check if the setting value is correct.	
5. A speed command exceeding the overspeed alarm trigger level was input.	Check that the actual servo motor speed is higher than the overspeed alarm trigger level.	[G] [B] [A]
6. The servo motor reaches the maximum torque (maximum thrust) at acceleration.	Check if the torque (thrust) is the maximum torque (maximum thrust) at the acceleration. If the torque (thrust) is the maximum torque (maximum thrust), increase the acceleration/deceleration time constants or reduce the load.	
7. The servo system is unstable and oscillating.	Check if the servo motor is oscillating. If the servo motor is oscillating, adjust the servo gain or reduce the load.	
8. The velocity waveform overshoot.	Check if the velocity waveform has overshoot because of the short acceleration/deceleration time constant. If the velocity waveform has overshoot, increase the acceleration/deceleration time constant.	
9. The servo motor operation is suddenly interrupted by load interference (such as mechanical interference) and then resumed.	Check the equipment for load interference. If there is load interference, remove the cause of the interference. When an external brake is used, check the brake open timing.	
10. The connection destination of the servo motor power cable or the encoder cable is incorrect.	Check for any incorrect connection destination of the motor power cable or encoder cable. Refer to "Example power circuit connections" in the following manuals. □MR-J5 User's Manual (Hardware) □MR-J5D User's Manual (Hardware)	
11. The servo motor power cable was disconnected. (Instantaneous open-phase due to disconnection of one of the U/V/W cables)	Check if the motor power cable is disconnected. If the motor power cable is disconnected, correct the wiring.	
12. The connection of the servo motor is incorrect.	Check the U/V/W wiring. Refer to "Example power circuit connections" in the following manuals. □MR-J5 User's Manual (Hardware) □MR-J5D User's Manual (Hardware) Refer to "Turning on servo amplifier for the first time" in the User's Manual (Introduction).	
13. The encoder or linear encoder has malfunctioned.	Check if this alarm occurs when the servo motor rotates at the lower speed than the maximum speed. If the alarm occurs, replace the servo motor or the linear encoder. To change the judgment value used to the permissible speed, change the setting of [Pr. PA28.4].	

[AL. 032_Overcurrent]

- A current higher than the permissible current flowed in the servo amplifier.

[AL. 032.1_Overcurrent detected via hardware detection circuit (during operation)]

Cause	Check/action method	Model
1. The servo amplifier has malfunctioned.	Check if the servo motor power cable has a ground fault. If the servo motor power cable has a ground fault, correct the wiring. Check that this alarm occurs as the servo motor power cables (U/V/W) are disconnected. If the alarm occurs, replace the servo amplifier.	[G] [B] [A]
2. The servo motor power cable has a ground fault or has shorted.	Check if the servo motor power cable has shorted. If the servo motor power cable has shorted, replace the servo motor power cable.	
3. The servo motor has malfunctioned.	After disconnecting the servo motor power cables on the servo motor side, check the insulation between phases (U/V/W/⊕ or ⊕/⊕). If the servo motor has a ground fault or has shorted, replace the servo motor.	
4. The dynamic brake has malfunctioned.	After confirming that the Cause 1, 2, and 3 did not apply, check if this alarm occurs when turning on the servo-on command. If the alarm occurs, replace the servo amplifier. If the alarm does not occur, check 5.	
5. The wiring of the regenerative resistor (regenerative option) is incorrect.	If an alarm occurs during regeneration, check if the regenerative resistor (regenerative option) is wired correctly and P+ and C are not short-circuited. If the regenerative resistor (regenerative option) is wired incorrectly, correct the wiring.	
6. The regenerative resistor (regenerative option) and the servo amplifier are connected in a wrong combination.	Check if the combination of the regenerative resistor (regenerative option) and the servo amplifier is correct as specified. Refer to "Regenerative option" in the following manual.  MR-J5 User's Manual (Hardware)	
7. The connection destination of the servo motor power cable or the encoder cable is incorrect.	Check the connection destination of the motor power cable or encoder cable. Refer to "Example power circuit connections" in the following manuals.  MR-J5 User's Manual (Hardware)  MR-J5D User's Manual (Hardware)	
8. There is a problem with the surrounding environment.	Check the noise, ambient temperature, and other conditions, and implement appropriate countermeasures for the cause. If a problem is not found with the surrounding environment, perform the following check/action methods.  Page 78 [AL. 045.1_Main circuit device overheat error 1] If there is noise, take countermeasures to reduce the noise. Refer to "Noise reduction techniques" in the following manuals.  MR-J5 User's Manual (Hardware)  MR-J5D User's Manual (Hardware)	

[AL. 032.2_Overcurrent detected via software detection processing (during operation)]

Cause	Check/action method	Model
1. The servo gain is too high.	Check if there is vibration. If there is vibration, reduce the value in [Pr. PB09 Speed control gain].	[G] [B] [A]
2. The servo amplifier has malfunctioned.	Check that this alarm occurs as the servo motor power cables (U/V/W) are disconnected. If the alarm occurs, replace the servo amplifier.	
3. The servo motor power cable has a ground fault or has shorted.	Check if the servo motor power cable has a ground fault. If the servo motor power cable has a ground fault, correct the wiring. Check if the servo motor power cable has shorted. If the servo motor power cable has shorted, replace the servo motor power cable.	
4. The servo motor has malfunctioned.	After disconnecting the servo motor power cables on the servo motor side, check the insulation between phases (U/V/W/⊕ or ⊖). If the servo motor has a ground fault or has shorted, replace the servo motor.	
5. The connection destination of the servo motor power cable or the encoder cable is incorrect.	Check the connection destination of the motor power cable or encoder cable. Refer to "Example power circuit connections" in the following manuals. <ul style="list-style-type: none"> ☞ MR-J5 User's Manual (Hardware) ☞ MR-J5D User's Manual (Hardware) 	
6. There is a problem with the surrounding environment.	Check the noise, ambient temperature, and other conditions, and implement appropriate countermeasures for the cause. If there is noise, take countermeasures to reduce the noise. Refer to "Noise reduction techniques" in the following manuals. <ul style="list-style-type: none"> ☞ MR-J5 User's Manual (Hardware) ☞ MR-J5D User's Manual (Hardware) 	

[AL. 032.3_Overcurrent detected via hardware detection circuit (during a stop)]

☞ Page 66 [AL. 032.1_Overcurrent detected via hardware detection circuit (during operation)]

[AL. 032.4_Overcurrent detected via software detection processing (during a stop)]

☞ Page 67 [AL. 032.2_Overcurrent detected via software detection processing (during operation)]

[AL. 033_Overvoltage]

- The value of the bus voltage exceeded the specified value.

200 V class: 400 V DC

400 V class: 800 V DC (840 V for the MR-J5D_)

[AL. 033.1_Main circuit voltage error]

Cause	Check/action method	Model
1. The settings of the regenerative resistor (regenerative option) are incorrect.	Check the regenerative resistor (regenerative option) in use and the setting value of [Pr. PA02.0-1 Regenerative option selection]. Refer to "Regenerative option" in the following manual. ☐MR-J5 User's Manual (Hardware)	[G] [B] [A]
2. The regenerative resistor (regenerative option) is not connected.	When the regenerative option is not used, check if P+ and D are connected correctly. When the regenerative option is used, disconnect the wiring between P+ and D and check if the regenerative option is attached between P+ and C. Refer to "Regenerative option" in the following manual. ☐MR-J5 User's Manual (Hardware)	
3. The built-in regenerative resistor or regenerative option is disconnected.	Measure the resistance value of the built-in regenerative resistor or regenerative option. If the resistance value is abnormal, take corrective actions as follows: <ul style="list-style-type: none"> • When using a built-in regenerative resistor, replace the servo amplifier. • When using a regenerative option, replace the regenerative option. Refer to "Regenerative option" in the following manual. ☐MR-J5 User's Manual (Hardware)	
4. The regeneration capacity is insufficient.	Set a longer deceleration time constant, then check the repeatability. If the error does not repeat, take corrective actions as follows: <ul style="list-style-type: none"> • When using a built-in regenerative resistor, use a regenerative option. • When using a regenerative option, use one with a larger capacity. 	
5. The power supply voltage is too high.	Check if the voltage of the input power supply exceeds the upper limit of the permissible voltage. If the power supply voltage exceeds the upper limit, reduce the power supply voltage. 200 V class: 264 V AC 400 V class: 528 V AC	
6. The motor power cable (U/V/W cables) has a ground fault. (Increase in the bus voltage between P and N due to a sneak current caused by the ground fault.)	Check if the servo motor power cable has a ground fault. If the servo motor power cable has a ground fault, correct the wiring. If the motor power cable is wired over a long distance or a shielded wire is used, a charging phenomenon may occur due to the stray capacitance in the wiring. Review and correct the wiring condition by means such as using a shorter cable and removing the shielded wire.	
7. There is a problem with the surrounding environment.	Check the noise, ambient temperature, and other conditions, and implement appropriate countermeasures for the cause. If there is noise, take countermeasures to reduce the noise. Refer to "Noise reduction techniques" in the following manuals. ☐MR-J5 User's Manual (Hardware) ☐MR-J5D User's Manual (Hardware)	
8. The servo amplifier has malfunctioned.	Check the value of the bus voltage. If the bus voltage exceeds the specified value even though the voltage of the main circuit power supply is within the specifications, replace the servo amplifier.	

[AL. 034_SSCNET receive error 1]

- An error occurred in SSCNET III/H communication. (Communication error for a continuous time of 3.5 ms)

[AL. 034.1_SSCNET receive data error]

Cause	Check/action method	Model
1. An SSCNET III cable is disconnected.	Check if the SSCNET III cable is connected correctly. Turn off the control circuit power supply of the servo amplifier, then connect the SSCNET III cable correctly.	[B]
2. An SSCNET III cable end is dirty.	Wipe the dirt off the cable end, then check the repeatability. If the error does not repeat, take preventive measures so that the SSCNET III cable end does not become dirty.	
3. An SSCNET III cable is broken or disconnected.	Check the SSCNET III cable for abnormality. If there is a problem with the SSCNET III cable, replace the cable.	
4. Vinyl tape has been applied to an SSCNET III cable.	Check if vinyl tape has been used. If it has been used, implement appropriate countermeasures for the cause.	
5. A wire insulator containing migratory plasticizer adhered to an SSCNET III cable.	Check if the cable comes into contact with other cables. If the cables are contacting, implement appropriate countermeasures for the cause.	
6. There is a problem with the surrounding environment.	Check the noise, ambient temperature, and other conditions, and implement appropriate countermeasures for the cause. If there is noise, take countermeasures to reduce the noise. Refer to "Noise reduction techniques" in the following manual. □MR-J5 User's Manual (Hardware)	
7. The servo amplifier has malfunctioned.	Replace the servo amplifier, then check the repeatability. If the error does not repeat, replace the servo amplifier.	
8. An alarm occurred in a servo amplifier, and the servo amplifier of the previous or next axis malfunctioned.	Replace the servo amplifier of the previous or next axis, then check the repeatability. If the error does not repeat, replace the servo amplifier.	
9. The controller has malfunctioned.	Replace the controller, then check the repeatability. If the error does not repeat, replace the controller.	

[AL. 034.2_SSCNET connector connection error]

☞ Page 69 [AL. 034.1_SSCNET receive data error]

[AL. 034.3_SSCNET communication data error]

☞ Page 69 [AL. 034.1_SSCNET receive data error]

[AL. 034.4_Hardware error signal detection]

☞ Page 69 [AL. 034.1_SSCNET receive data error]

[AL. 034.7_SSCNET communication data error 2]

☞ Page 69 [AL. 034.1_SSCNET receive data error]

[AL. 035_Command frequency error]

- The input command pulse frequency is too high.

[AL. 035.1_Command frequency error]

Cause	Check/action method	Model
1. The command pulse frequency is too high.	Check the command pulse frequency, and if the command pulse frequency exceeds the maximum input pulse frequency, review the operation pattern.	[A]
2. The setting of [Pr. PA13.2 Command input pulse train filter selection] is incorrect.	Check that the setting value of [Pr. PA13.2] is the value that matches the command pulse frequency.	
3. The command from the controller is excessive.	Check if the command from the controller exceeds the maximum speed. If the command exceeds the maximum speed, review the operation pattern. To change the judgment value used to the permissible speed, change the setting of [Pr. PA28.4 Speed range limit selection].	[G] [B]
4. The backlash compensation set in the controller is excessive.	Refer to the manual for the controller being used to check if the setting value is correct.	
5. The setting value of [Pr. PC90 Command frequency error threshold] is too low.	Check the command pulse frequency, and if the command pulse frequency exceeds the setting value, increase the setting value.	[A]
6. The controller has malfunctioned.	Replace the controller.	[G]
7. There is a problem with the surrounding environment.	Check the noise, ambient temperature, and other conditions, and implement appropriate countermeasures for the cause. If there is noise, take countermeasures to reduce the noise. Refer to "Noise reduction techniques" in the following manuals. <ul style="list-style-type: none"> 📖 MR-J5 User's Manual (Hardware) 📖 MR-J5D User's Manual (Hardware) 	[G] [B] [A]

[AL. 036_SSCNET receive error 2]

- An error occurred in SSCNET III/H communication. (Communication error for an intermittent time of about 70 ms)

[AL. 036.1_Intermittent communication data error]

Cause	Check/action method	Model
1. An SSCNET III cable is disconnected.	Check if the SSCNET III cable is connected correctly. Turn off the control circuit power supply of the servo amplifier, then connect the SSCNET III cable correctly.	[B]
2. An SSCNET III cable end is dirty.	Wipe the dirt off the cable end, then check the repeatability. If the error does not repeat, take preventive measures so that the SSCNET III cable end does not become dirty.	
3. An SSCNET III cable is broken or disconnected.	Check the SSCNET III cable for abnormality. If there is a problem with the SSCNET III cable, replace the cable.	
4. Vinyl tape has been applied to an SSCNET III cable.	Check if vinyl tape has been used. If it has been used, implement appropriate countermeasures for the cause.	
5. A wire insulator containing migratory plasticizer adhered to an SSCNET III cable.	Check if the cable comes into contact with other cables. If the cables are contacting, implement appropriate countermeasures for the cause.	
6. There is a problem with the surrounding environment.	Check the noise, ambient temperature, and other conditions, and implement appropriate countermeasures for the cause. If there is noise, take countermeasures to reduce the noise. Refer to "Noise reduction techniques" in the following manual. □MR-J5 User's Manual (Hardware)	
7. The servo amplifier has malfunctioned.	Replace the servo amplifier, then check the repeatability. If the error does not repeat, replace the servo amplifier.	
8. An alarm occurred in a servo amplifier, and the servo amplifier of the previous or next axis malfunctioned.	Replace the servo amplifier of the previous or next axis, then check the repeatability. If the error does not repeat, replace the servo amplifier.	
9. The controller has malfunctioned.	Replace the controller, then check the repeatability. If the error does not repeat, replace the controller.	

[AL. 037_Parameter error]

- Servo parameter setting values are incorrect.
- Point table setting values are incorrect.

[AL. 037.1_Parameter setting range error]

Cause	Check/action method	Model
1. A parameter was set outside of the setting range.	[G] [B]: Check the parameter error No. on the alarm display screen of MR Configurator2 or with another method, then review the setting value of the parameter. [A]: Check the parameter error No. on the parameter error No. display screen of the servo amplifier display, the alarm display screen of MR Configurator2, or with another method, and review the setting value of the parameter.	[G] [B] [A]
2. An inconsistent combination of parameters has been set.	[G] [B]: Check the parameter error No. on the alarm display screen of MR Configurator2 or with another method, then review the setting value of the parameter. [A]: Check the parameter error No. on the parameter error No. display screen of the servo amplifier display, the alarm display screen of MR Configurator2, or with another method, and review the setting value of the parameter.	
3. The setting value of the parameter has changed due to the servo amplifier malfunction.	Replace the servo amplifier.	

[AL. 037.2_Parameter combination error]

Cause	Check/action method	Model
1. An inconsistent combination of parameters has been set.	[G] [B]: Check the parameter error No. on the alarm display screen of MR Configurator2 or with another method, then review the setting value of the parameter. [A]: Check the parameter error No. on the parameter error No. display screen of the servo amplifier display, the alarm display screen of MR Configurator2, or with another method, and review the setting value of the parameter.	[G] [B] [A]
2. When the master-slave operation function is enabled, [Pr. PA01.1 Operation mode selection] on the master side is set to a value other than "0" (standard control mode).	Set [Pr. PA01.1] to "0" (standard control mode).	[G] [B]
3. When the master-slave operation function is enabled, [Pr. PA01.1 Operation mode selection] on the slave side is set to a value other than "0" (standard control mode).	Set [Pr. PA01.1] to "0" (standard control mode).	
4. When the master-slave function is enabled, [Pr. PA04.3 Forced stop deceleration function selection] is set to "2" (Forced stop deceleration function enabled).	Set [Pr. PA04.3] to "0" (Forced stop deceleration function disabled).	[B]

[AL. 037.3_Point table setting error]

Cause	Check/action method	Model
1. Point table setting values are incorrect.	Check if the setting value of the point table is within the setting range. Check the error number of the point table with [Point table error No.(Obj. 2A43h: 01h)]. Or check the setting value in the point table screen of MR Configurator2.	[G]
2. The setting value of the point table has changed due to the servo amplifier malfunction.	Replace the servo amplifier.	

[AL. 037.6_Parameter mismatch error]

Cause	Check/action method	Model
1. Mismatching with the saved parameters occurred because of the error in writing parameters.	[G] [B]: Check the parameter error No. on the alarm display screen of MR Configurator2 or with another method. Rewrite the setting value because the value before or after writing has been displayed. [A]: Check the parameter error No. on the parameter error No. display screen of the servo amplifier display, the alarm display screen of MR Configurator2, or another method. Rewrite the setting value because the value before or after writing has been displayed.	[G] [B] [A]
2. The setting value of the parameter changed as the servo amplifier malfunctioned.	Replace the servo amplifier.	

[AL. 037.7_Network parameter setting error]

Cause	Check/action method	Model
1. There is a problem with the network parameter settings.	Check if the setting value of the network parameter is within the setting range. [G]: Check the servo parameter error No. on the alarm display screen of MR Configurator2 or with another method. Rewrite the setting value because the value before or after writing has been displayed. [A]: Check the parameter error No. on the parameter error No. display screen of the servo amplifier display, the alarm display screen of MR Configurator2, or another method. Rewrite the setting value because the value before or after writing has been displayed.	[G] [A]
2. The setting value of the network parameter changed as the servo amplifier malfunctioned.	Replace the servo amplifier.	

[AL. 03A_Inrush current suppression circuit error]

- The inrush current suppression circuit error was detected.

[AL. 03A.1_Inrush current suppression circuit error]

Cause	Check/action method	Model
1. The inrush current limit resistor is overheated due to frequent power ON/OFF.	Review the usage.	[G] [B] [A]
2. The servo amplifier has malfunctioned.	Replace the servo amplifier.	

[AL. 03D_Driver communication parameter setting error]

- The setting values of control parameters for inter-driver communication are incorrect.

[AL. 03D.1_Slave-side driver communication parameter combination error]

Cause	Check/action method	Model
1. The master-side transmission data selection for inter-driver communication has not been set correctly.	Review the settings of "Driver communication setting - Master - Transmit data selection 1" and "Driver communication setting - Master - Transmit data selection 2" with the following parameters. [B]: [Pr. PD16 Driver communication setting - Master - Transmit data selection 1] and [Pr. PD17 Driver communication setting - Master - Transmit data selection 2]	[B]

[AL. 03D.2_Master-side driver communication parameter combination error]

Page 74 [AL. 03D.1_Slave-side driver communication parameter combination error]

[AL. 03E_Operation mode error]

- The operation mode settings have been changed.

[AL. 03E.4_Control command mismatch 1]

Cause	Check/action method	Model
1. The control mode of the MR-J5-_B_-LL servo amplifier was switched to the torque control mode.	Check if the control mode was switched to the torque control mode. If the control mode was switched, review the controller setting.	[B]

[AL. 03E.5_Control command mismatch 2]

Cause	Check/action method	Model
1. The control mode of the MR-J5-_B_-LL servo amplifier was switched to the continuous operation to torque control mode.	Check if the control mode was switched to the continuous operation to torque control mode. If the control mode was switched, review the controller setting.	[B]

[AL. 03E.9_Connection mode error 1]

Cause	Check/action method	Model
1. When an SSCNET III/H controller is connected, the operation mode is not set to MR-J5.	Restore the settings of the servo amplifier to the factory settings by using the application "MR Mode Change" came with MR Configurator2, set the operation mode of the controller to MR-J5, then establish a connection.	[B]

[AL. 042_Servo control error]

- A servo control error occurred. (When a linear servo motor or a direct drive motor is used or in a fully closed loop control)

[AL. 042.1_Servo control error based on position deviation]

Cause	Check/action method	Model
1. [Pr. PA17 Servo motor series setting] and [Pr. PA18 Servo motor type setting] were not set based on the servo motor to be used.	Check if [Pr. PA17] and [Pr. PA18] have been set correctly.	[G] [B] [A]
2. The settings of the encoder resolution differ from the actual value.	Check the settings of [Pr. PL02 Linear encoder resolution setting - Numerator] and [Pr. PL03 Linear encoder resolution setting - Denominator]. Refer to "Linear encoder resolution setting" in the following manual. □MR-J5 User's Manual (Hardware)	
3. The mounting direction of the encoder is incorrect.	Check the polarities of the linear encoder and the linear servo motor. If the mounting direction is incorrect, mount the encoder correctly. Change the setting of "Encoder pulse count polarity selection" as required. [G] [B]: [Pr. PC27.0 Encoder pulse count polarity selection] [A]: [Pr. PC45.0 Encoder pulse count polarity selection] Refer to "Setting of linear encoder direction and linear servo motor direction" in the following manual. □MR-J5 User's Manual (Hardware)	
4. The connection of the servo motor is incorrect.	Check the wiring. Refer to "SIGNALS AND WIRING" in the following manual. □MR-J5 User's Manual (Hardware)	
5. The initial magnetic pole detection was not executed.	Execute the magnetic pole detection, then check the repeatability. Refer to "Magnetic pole detection" in the following manual. □MR-J5 User's Manual (Hardware)	
6. The setting value of the position deviation error detection level is too low.	Check the value of the droop pulses. If the deviation is too large, review the operation status. Review the setting of [Pr. PL05 Position deviation error detection level] as required.	

[AL. 042.2_Servo control error based on speed deviation]

Cause	Check/action method	Model
1. [Pr. PA17 Servo motor series setting] and [Pr. PA18 Servo motor type setting] were not set based on the servo motor to be used.	Check if [Pr. PA17] and [Pr. PA18] have been set correctly.	[G] [B] [A]
2. The settings of the encoder resolution differ from the actual value.	Check the settings of [Pr. PL02 Linear encoder resolution setting - Numerator] and [Pr. PL03 Linear encoder resolution setting - Denominator]. Refer to "Linear encoder resolution setting" in the following manual. □MR-J5 User's Manual (Hardware)	
3. The mounting direction of the encoder is incorrect.	Check the polarities of the linear encoder and the linear servo motor. Change the setting of "Encoder pulse count polarity selection" as required. [G] [B]: [Pr. PC27.0 Encoder pulse count polarity selection] [A]: [Pr. PC45.0 Encoder pulse count polarity selection] Refer to "Setting of linear encoder direction and linear servo motor direction" in the following manual. □MR-J5 User's Manual (Hardware)	
4. The connection of the servo motor is incorrect.	Check the wiring. Refer to "SIGNALS AND WIRING" in the following manual. □MR-J5 User's Manual (Hardware)	
5. The initial magnetic pole detection was not executed.	Execute the magnetic pole detection, then check the repeatability. Refer to "Magnetic pole detection" in the following manual. □MR-J5 User's Manual (Hardware)	
6. The setting value of the speed deviation error detection level is too low.	Calculate the deviation between the speed command and actual speed. If the deviation is too large, review the operation status. Review the setting of [Pr. PL06 Speed deviation error detection level] as required.	



[AL. 042.3_Servo control error based on torque/thrust deviation]

Cause	Check/action method	Model
1. [Pr. PA17 Servo motor series setting] and [Pr. PA18 Servo motor type setting] were not set based on the servo motor to be used.	Check if [Pr. PA17] and [Pr. PA18] have been set correctly.	[G] [B] [A]
2. The settings of the encoder resolution differ from the actual value.	Check the settings of [Pr. PL02 Linear encoder resolution setting - Numerator] and [Pr. PL03 Linear encoder resolution setting - Denominator]. Refer to "Linear encoder resolution setting" in the following manual. MR-J5 User's Manual (Hardware)	
3. The mounting direction of the encoder is incorrect.	Check the polarities of the linear encoder and the linear servo motor. Change the setting of "Encoder pulse count polarity selection" as required. [G] [B]: [Pr. PC27.0 Encoder pulse count polarity selection] [A]: [Pr. PC45.0 Encoder pulse count polarity selection] Refer to "Setting of linear encoder direction and linear servo motor direction" in the following manual. MR-J5 User's Manual (Hardware)	
4. The connection of the servo motor is incorrect.	Check the wiring. Refer to "SIGNALS AND WIRING" in the following manual. MR-J5 User's Manual (Hardware)	
5. The initial magnetic pole detection was not executed.	Check the repeatability. Refer to "Magnetic pole detection" in the following manual. MR-J5 User's Manual (Hardware)	
6. The setting value in the torque/thrust deviation error detection level is too low.	Calculate the deviation between the current command and torque/thrust. If the deviation is too large, review the power-supply environment or the operation status. Review the setting of [Pr. PL07 Torque deviation error detection level] as required.	

[AL. 042.8_Fully closed loop control error based on position deviation]

Cause	Check/action method	Model
1. The settings of the load-side encoder resolution differ from the actual value.	Check the settings of [Pr. PE04 Fully closed loop control - Feedback pulse electronic gear 1 - Numerator] and [Pr. PE05 Fully closed loop control - Feedback pulse electronic gear 1 - Denominator].	[G] [B] [A]
2. The mounting direction of the load-side encoder is incorrect.	Check the mounting direction of the load-side encoder. Change the setting of "Encoder pulse count polarity selection" as required. [G] [B]: [Pr. PC27.0 Encoder pulse count polarity selection] [A]: [Pr. PC45.0 Encoder pulse count polarity selection] Refer to "Checking position data of the load-side encoder" in the following manuals. MR-J5 User's Manual (Hardware) MR-J5D User's Manual (Hardware)	
3. The setting value of the position deviation error detection level is too low.	Check the value of the motor-side/load-side position deviation. If the deviation is too large, review the mechanism of the equipment or the operation status. Review the setting of [Pr. PE03 Fully closed loop control error - Detection function selection] or [Pr. PE07 Fully closed loop control - Position deviation error detection level] as required.	

[AL. 042.9_Fully closed loop control error based on speed deviation]

Cause	Check/action method	Model
1. The settings of the load-side encoder resolution differ from the setting value.	Check the settings of [Pr. PE04 Fully closed loop control - Feedback pulse electronic gear 1 - Numerator] and [Pr. PE05 Fully closed loop control - Feedback pulse electronic gear 1 - Denominator].	[G] [B] [A]
2. The mounting direction of the load-side encoder is incorrect.	Check the mounting direction of the load-side encoder. Change the setting of "Encoder pulse count polarity selection" as required. [G] [B]: [Pr. PC27.0 Encoder pulse count polarity selection] [A]: [Pr. PC45.0 Encoder pulse count polarity selection] Refer to "Checking position data of the load-side encoder" in the following manuals.  MR-J5 User's Manual (Hardware)  MR-J5D User's Manual (Hardware)	
3. The setting value of the speed deviation error detection level is too low.	Calculate the motor-side/load-side speed deviation. If the deviation is too large, review the mechanism of the equipment or the operation status. Review the setting of [Pr. PE03 Fully closed loop control error - Detection function selection] or [Pr. PE06 Fully closed loop control - Speed deviation error detection level] as required.	

[AL. 042.A_Fully closed loop control error based on position deviation during command stop]

 Page 76 [AL. 042.8_Fully closed loop control error based on position deviation]

[AL. 045_Main circuit device overheat]

- The inside of the servo amplifier overheated.

[AL. 045.1_Main circuit device overheat error 1]

Cause	Check/action method	Model
1. The ambient temperature exceeded the specified value (60 °C).	Check the ambient temperature, and if the temperature exceeds the specified value, lower the ambient temperature.	[G] [B] [A]
2. The servo amplifier does not meet the specifications of close mounting.	Check the specifications of close mounting. Refer to "Mounting direction and clearances" in the following manual. MR-J5 User's Manual (Hardware)	
3. The power was turned on and off repeatedly under the overload status.	Check if the overload status occurred frequently. If the overload status occurred frequently, review the operation pattern.	
4. A cooling fan, heat sink, or opening is clogged.	Clean the cooling fan, heat sink, or openings.	
5. The servo amplifier has malfunctioned.	Replace the servo amplifier.	

[AL. 045.2_Main circuit device overheat error 2]

Page 78 [AL. 045.1_Main circuit device overheat error 1]

[AL. 046_Servo motor overheat]

- The servo motor overheated.

[AL. 046.1_Servo motor temperature error 1]

Cause	Check/action method	Model
1. The ambient temperature of the servo motor has exceeded the specified value.	Check the ambient temperature of the servo motor, and if the temperature exceeds the specified value, lower the ambient temperature. Refer to "Environment" in the following manuals. Rotary Servo Motor User's Manual (For MR-J5) Direct Drive Motor User's Manual Refer to "Environment" in the Linear Servo Motor User's Manual.	[G] [B] [A]
2. The servo motor is overloaded.	Check the effective load ratio. If the effective load ratio exceeds 100 %, reduce the load or review the operation pattern.	
3. The thermal sensor in the encoder has malfunctioned.	Check the servo motor temperature when the alarm occurs. If the servo motor temperature is too low, the thermal sensor in the encoder is faulty. Replace the servo motor.	

[AL. 046.2_Servo motor temperature error 2]

Cause	Check/action method	Model
1. The ambient temperature of the linear servo motor, direct drive motor, or servo motor with thermistors has exceeded the specified value.	Check the ambient temperature of the linear servo motor, direct drive motor, or servo motor with thermistors. If the ambient temperature exceeds the specified value, lower the ambient temperature. Refer to "Environment" in the following manuals. Rotary Servo Motor User's Manual (For MR-J5) Direct Drive Motor User's Manual Refer to "Environment" in the Linear Servo Motor User's Manual.	[G] [B] [A]
2. The servo motor is overloaded.	Check the effective load ratio. If the effective load ratio exceeds 100 %, reduce the load or review the operation pattern.	
3. There is a problem with the thermistor wire.	Check if the thermistor wire has shorted. If the thermistor wire has shorted, replace or repair the cable. If the thermistor wire has not shorted, replace the servo motor.	

[AL. 046.3_Thermistor disconnected error]

Cause	Check/action method	Model
1. A servo motor thermistor wire is not connected.	Check if the servo motor thermistor wire is connected.	[G] [B] [A]
2. A servo motor thermistor wire is disconnected.	Check for disconnection in the servo motor thermistor wire. If the servo motor thermistor wire is disconnected, repair the wire.	

[AL. 046.4_Thermistor circuit error]

Cause	Check/action method	Model
1. The thermistor circuit of the servo amplifier has malfunctioned.	Replace the servo amplifier.	[G] [B] [A]

[AL. 046.5_Servo motor temperature error 3]

Page 79 [AL. 046.1_Servo motor temperature error 1]

[AL. 046.6_Servo motor temperature error 4]

Cause	Check/action method	Model
1. A current larger than the continuous output current of the servo motor flowed.	Check the effective load ratio. If the effective load ratio is too high, reduce the load or review the operation pattern. Alternatively, replace the servo motor with a larger-capacity servo motor.	[G] [B] [A]

[AL. 046.7_Servo motor temperature error 5]

Cause	Check/action method	Model
1. Values of the servo parameters for manufacturer setting have been changed.	Set the servo parameters for manufacturer setting to the initial values.	[G] [B] [A]

[AL. 047_Cooling fan error]

- The speed of the servo amplifier cooling fan decreased.
- The fan speed decreased to 30 % or less of the rated speed of the alarm occurrence level.

[AL. 047.1_Cooling fan stop error]

Cause	Check/action method	Model
1. A foreign object was caught in the cooling fan.	Check if a foreign object is caught in the cooling fan. If a foreign object is found, remove it.	[G] [B] [A]
2. The cooling fan has contaminated and damaged. (Contamination and damage due to oil or other liquid ingress)	Check the condition of the cooling fan. If it is contaminated and damaged, replace the fan unit. Review the usage environment as needed.	
3. The cooling fan has reached the end of its service life.	Replace the fan unit.	
4. The servo amplifier has malfunctioned.	Replace the servo amplifier.	

[AL. 047.2_Decreased cooling fan speed error]

Cause	Check/action method	Model
1. A foreign object was caught in the cooling fan.	Check if a foreign object is caught in the cooling fan. If a foreign object is found, remove it.	[G] [B] [A]
2. The cooling fan has contaminated and damaged. (Contamination and damage due to oil or other liquid ingress)	Check the condition of the cooling fan. If it is contaminated and damaged, replace the fan unit. Review the usage environment as needed.	
3. The cooling fan has reached the end of its service life.	Replace the fan unit.	

[AL. 050_Overload 1]

- The load exceeded the overload protection characteristics of the servo amplifier.

[AL. 050.1_Thermal overload error 1 during operation]

Cause	Check/action method	Model
1. The servo motor power cable was disconnected.	Check the servo motor power cable, then repair or replace the cable.	[G] [B] [A]
2. The connection of the servo motor is incorrect.	Check the U/V/W wiring. Refer to "Example power circuit connections" in the following manuals. ☐MR-J5 User's Manual (Hardware) ☐MR-J5D User's Manual (Hardware)	
3. The electromagnetic brake has not been released. (The electromagnetic brake has been activated.)	Check if the electromagnetic brake has been released during operation.	
4. A current larger than the continuous output current of the servo motor flowed.	Check the effective load ratio and operation pattern. If the effective load ratio is too high, reduce the load or replace the servo motor with a larger-capacity servo motor. Alternatively, review the operation pattern.	
5. For a multi-axis servo amplifier, the connection destination of the encoder cable is incorrect.	Check the connection destinations of CN2A, CN2B, and CN2C.	[G] [B]
6. The servo system is unstable and resonating.	Adjust the gain so that the system does not resonate. Refer to the following manual. ☐MR-J5 User's Manual (Adjustment)	[G] [B] [A]
7. The servo amplifier has malfunctioned.	Replace the servo amplifier.	
8. The encoder (servo motor) or linear encoder has malfunctioned.	Replace the servo motor or linear encoder.	
9. There is a problem with the mounting environment of the servo motor.	Check the servo motor shaft for any eccentric load due to a center deviation. If there is a problem, review the mounting environment.	



[AL. 050.2_Thermal overload error 2 during operation]

☞ Page 82 [AL. 050.1_Thermal overload error 1 during operation]

[AL. 050.3_Thermal overload error 4 during operation]

☞ Page 82 [AL. 050.1_Thermal overload error 1 during operation]

[AL. 050.4_Thermal overload error 1 during a stop]

Cause	Check/action method	Model
1. A moving part collided against the machine.	Review the operation pattern to avoid collision. Check if the machine is interfering with the servo motor.	[G] [B]
	Review the operation pattern to avoid collision. Check if the machine is interfering with the servo motor due to a position mismatch. Refer to "Investigating the cause of a position mismatch" in the following manual.  MR-J5-A User's Manual (Introduction)	[A]
2. The servo motor power cable was disconnected.	Check the servo motor power cable, then repair or replace the cable.	[G] [B] [A]
3. Hunting occurs during servo-lock.	Adjust the gain so that hunting does not occur. Refer to the following manual.  MR-J5 User's Manual (Adjustment)	
4. The electromagnetic brake has not been released. (The electromagnetic brake has been activated.)	Check if the electromagnetic brake has been released during operation.	
5. A current larger than the continuous output current of the servo motor flowed.	Check the effective load ratio and operation pattern. If the effective load ratio is too high, reduce the load or replace the servo motor with a larger-capacity servo motor. Alternatively, review the operation pattern.	
6. For a multi-axis servo amplifier, the connection destination of the encoder cable is incorrect.	Check the connection destinations of CN2A, CN2B, and CN2C.	[G] [B]
7. The servo system is unstable and resonating.	Adjust the gain so that the system does not resonate. Refer to the following manual.  MR-J5 User's Manual (Adjustment)	[G] [B] [A]
8. The servo amplifier has malfunctioned.	Replace the servo amplifier.	
9. The encoder (servo motor) or linear encoder has malfunctioned.	Replace the servo motor or linear encoder.	

[AL. 050.5_Thermal overload error 2 during a stop]

 Page 83 [AL. 050.4_Thermal overload error 1 during a stop]



[AL. 050.6_Thermal overload error 4 during a stop]

 Page 83 [AL. 050.4_Thermal overload error 1 during a stop]



[AL. 051_Overload 2]

- Maximum output current continuously flowed due to machine collision or other causes.

[AL. 051.1_Thermal overload error 3 during operation]

Cause	Check/action method	Model
1. The servo motor power cable was disconnected.	Repair or replace the servo motor power cable.	[G] [B] [A]
2. The connection of the servo motor is incorrect.	Check the U/V/W wiring. Refer to "Example power circuit connections" in the following manuals.  MR-J5 User's Manual (Hardware)  MR-J5D User's Manual (Hardware)	
3. The connection of the encoder cable is incorrect.	Check if the encoder cable is connected correctly.	
4. The torque is insufficient.	Check the peak load ratio. If the torque is saturated, reduce the load or review the operation pattern. Alternatively, replace the servo motor with a larger-capacity servo motor.	
5. The servo amplifier has malfunctioned.	Replace the servo amplifier.	
6. The encoder (servo motor) or linear encoder has malfunctioned.	Replace the servo motor or linear encoder.	

[AL. 051.2_Thermal overload error 3 during a stop]

Cause	Check/action method	Model
1. A moving part collided against the machine.	Review the operation pattern to avoid collision. Check if the machine is interfering with the servo motor.	[G] [B]
	Review the operation pattern to avoid collision. Check if the machine is interfering with the servo motor due to a position mismatch. Refer to "Investigating the cause of a position mismatch" in the following manual.  MR-J5-A User's Manual (Introduction)	[A]
2. The servo motor power cable was disconnected.	 Page 84 [AL. 051.1_Thermal overload error 3 during operation]	[G] [B] [A]
3. The connection of the servo motor is incorrect.		
4. The connection of the encoder cable is incorrect.		
5. The torque is saturated.		
6. The servo amplifier has malfunctioned.		
7. The encoder or linear encoder has malfunctioned.		

[AL. 052_ Excessive error]

- Droop pulses exceeded the alarm occurrence level.

[AL. 052.1_ Excessive droop pulse 1]

Cause	Check/action method	Model
1. The servo motor power cable was disconnected.	Repair or replace the servo motor power cable.	[G] [B] [A]
2. The connection of the servo motor is incorrect.	Check the U/V/W wiring for forgotten screws, loose screws, and incorrect wiring. Refer to "Example power circuit connections" in the following manuals. ☐ MR-J5 User's Manual (Hardware) ☐ MR-J5D User's Manual (Hardware)	
3. The connection of the encoder cable is incorrect.	Check if the encoder cable is connected correctly.	
4. The torque limit has been enabled.	If the torque has been limited, increase the torque limit value.	
5. A moving part collided against the machine.	Review the operation pattern to avoid collision. Check if the machine is interfering with the servo motor.	[G] [B]
	Review the operation pattern to avoid collision. Check if the machine is interfering with the servo motor due to a position mismatch. Refer to "Investigating the cause of a position mismatch" in the following manual. ☐ MR-J5-A User's Manual (Introduction)	[A]
6. The electromagnetic brake has not been released. (The electromagnetic brake has been activated.)	Check if the electromagnetic brake has been released during operation.	[G] [B] [A]
7. The torque is insufficient.	Check the peak load ratio. If the torque is saturated, reduce the load or review the operation pattern. Alternatively, replace the servo motor with a larger-capacity servo motor.	
8. The power supply voltage has dropped.	If the bus voltage is too low, review the power supply voltage and power supply capacity.	
9. Acceleration time constant is too short.	Set a longer acceleration/deceleration time constant, then check the repeatability. If the error does not repeat, increase the acceleration/deceleration time constant.	
10. The position control gain is too small.	Increase the position control gain, then check the repeatability. If the error does not repeat, increase the value in [Pr. PB08 position control gain].	
11. The excessive error alarm trigger level was not set correctly.	Check the setting of the excessive error alarm trigger level. [G] [B]: [Pr. PC01], [Pr. PC06.3] [A]: [Pr. PC24.3], [Pr. PC43]	
12. The servo motor shaft was rotated by an external force or the moving part of the linear servo motor was moved by an external force.	Measure the actual position under the servo-lock status. When an external force rotates the servo motor or moves the linear servo motor, review the machine.	
13. The servo amplifier has malfunctioned.	Replace the servo amplifier.	
14. The encoder or linear encoder has malfunctioned.	Replace the servo motor or linear encoder.	

[AL. 052.3_ Excessive droop pulse 2]

☞ Page 85 [AL. 052.1_ Excessive droop pulse 1]

[AL. 052.4_ Excessive error during 0 torque limit]

Cause	Check/action method	Model
1. The torque limit value is 0.	Do not input a command when the torque limit value is 0.	[G] [B] [A]

[AL. 052.5_ Excessive droop pulse 3]

Page 85 [AL. 052.1_ Excessive droop pulse 1]

[AL. 052.6_ Excessive droop pulse at servo-off]

Cause	Check/action method	Model
1. The servo motor shaft was rotated by an external force or the moving part of the linear servo motor was moved by an external force.	Make sure that the servo motor is not rotated (moved) by an external force.	[G] [B] [A]
2. When the servo motor was rotating or when the linear servo motor was moving, servo-on was executed.	Turn servo-on when the servo motor stops.	
3. The controller has malfunctioned.	Replace the controller, then check the repeatability.	
4. The encoder or the servo motor has malfunctioned.	Replace the servo motor or linear encoder, then check the repeatability.	
5. The servo amplifier has malfunctioned.	Replace the servo amplifier, then check the repeatability.	

[AL. 054_Oscillation detection]

- The oscillation of the servo motor was detected.

[AL. 054.1_Oscillation detection error]

Cause	Check/action method	Model
1. The servo system is unstable and oscillating.	Check the torque ripple with MR Configurator2. If the torque ripple is vibrating, adjust the servo gain with the auto tuning. Set the machine resonance suppression filter.	[G] [B] [A]
2. The resonance frequency has changed due to aging.	Measure the resonance frequency of the equipment and compare the value with the setting value of the machine resonance suppression filter. If the resonance frequency of the equipment and the value of the filter differs, change the setting of the machine resonance suppression filter.	
3. The encoder or linear encoder has malfunctioned.	Replace the servo motor or linear encoder.	

[AL. 056_Forced stop error]

- The servo motor failed to decelerate normally during a forced stop deceleration.

[AL. 056.2_Speed exceeded during forced stop]

Cause	Check/action method	Model
1. The forced stop deceleration time constant is short.	Set a larger value in "Deceleration time constant at forced stop", then check the repeatability. If the error does not repeat, adjust the deceleration time constant. [G] [B]: [Pr. PC24 Deceleration time constant at forced stop] [A]: [Pr. PC51 Deceleration time constant at forced stop]	[G] [B] [A]
2. The torque limit has been enabled.	If the torque has been limited, review the torque limit value.	
3. The servo system is unstable and oscillating.	Check the torque ripple with MR Configurator2. If the torque ripple is vibrating, adjust the servo gain with the auto tuning. Set the machine resonance suppression filter.	
4. The encoder or linear encoder has malfunctioned.	Replace the servo motor or linear encoder.	

[AL. 056.3_Estimated excess distance during forced stop]

Cause	Check/action method	Model
1. The forced stop deceleration time constant is short.	Set a larger value in "Deceleration time constant at forced stop", then check the repeatability. If the error does not repeat, adjust the deceleration time constant. [G] [B]: [Pr. PC24 Deceleration time constant at forced stop] [A]: [Pr. PC51 Deceleration time constant at forced stop]	[G] [B] [A]
2. The torque limit has been enabled.	If the torque has been limited, review the torque limit value.	
3. The encoder or linear encoder has malfunctioned.	Replace the servo motor or linear encoder.	

[AL. 056.5_Travel distance exceeded during forced stop 2]

☞ Page 88 [AL. 056.2_Speed exceeded during forced stop]

[AL. 061_Operation error]

- The operation of positioning function is incorrect.

[AL. 061.1_Point table setting range error]

Cause	Check/action method	Model
1. "1" or "3" is set for the auxiliary function of the last point table.	Review the settings of the auxiliary function.	[G]

[AL. 063_STO timing error]

- STO signal turned off when the servo motor is rotating.

[AL. 063.1_STO1 off]

Cause	Check/action method	Model
<p>1. While detection by [AL. 063 STO timing error] has been enabled, STO1 was turned off (enabled) under the following speed conditions.</p> <ul style="list-style-type: none">• Rotary servo motor speed: 50 r/min or higher• Linear servo motor speed: 50 mm/s or higher• Direct drive motor speed: 5 r/min or higher	<p>After the servo motor stops, turn off (enable) STO1. Review the settings of "STO timing error selection" with the following parameters. [G] [B]: [Pr. PF06.1 STO timing error selection] [A]: [Pr. PF09.1 STO timing error selection]</p>	[G] [B] [A]

[AL. 063.2_STO2 off]

Cause	Check/action method	Model
<p>1. While detection by [AL. 063 STO timing error] has been enabled, STO2 was turned off (enabled) under the following speed conditions.</p> <ul style="list-style-type: none">• Rotary servo motor speed: 50 r/min or higher• Linear servo motor speed: 50 mm/s or higher• Direct drive motor speed: 5 r/min or higher	<p>After the servo motor stops, turn off (enable) STO2. Review the settings of "STO timing error selection" with the following parameters. [G] [B]: [Pr. PF06.1 STO timing error selection] [A]: [Pr. PF09.1 STO timing error selection]</p>	[G] [B] [A]

[AL. 066_ Encoder initial communication error (safety sub-function)]

- The connected encoder is not compatible with the servo amplifier.
- There is a communication error between the encoder and servo amplifier.

[AL. 066.1_ Encoder initial communication - Receive data error 1 (safety sub-function)]

Cause	Check/action method	Model
1. There is a problem with the encoder cable.	Check if the encoder cable has been disconnected or has shorted. If there is a problem with the cable, repair or replace the cable.	[G] [A]
2. The servo amplifier has malfunctioned.	Replace the servo amplifier.	
3. The encoder has malfunctioned.	Replace the servo motor.	
4. There is a problem with the surrounding environment.	Check the power supply for noise. If there is noise, take countermeasures to reduce the noise. Refer to "Noise reduction techniques" in the following manuals. <input type="checkbox"/> MR-J5 User's Manual (Hardware) <input type="checkbox"/> MR-J5D User's Manual (Hardware)	

[AL. 066.2_ Encoder initial communication - Receive data error 2 (safety sub-function)]

☞ Page 91 [AL. 066.1_ Encoder initial communication - Receive data error 1 (safety sub-function)]

[AL. 066.3_ Encoder initial communication - Receive data error 3 (safety sub-function)]

☞ Page 91 [AL. 066.1_ Encoder initial communication - Receive data error 1 (safety sub-function)]

[AL. 066.7_ Encoder initial communication - Transmission data error 1 (safety sub-function)]

☞ Page 91 [AL. 066.1_ Encoder initial communication - Receive data error 1 (safety sub-function)]

[AL. 066.9_ Encoder initial communication - Processing error 1 (safety sub-function)]

Cause	Check/action method	Model
1. A servo motor with functional safety is not connected.	Use a servo motor with functional safety.	[G] [A]
2. Take actions in accordance with the items shown below.		

☞ Page 91 [AL. 066.1_ Encoder initial communication - Receive data error 1 (safety sub-function)]

[AL. 067_ Encoder normal communication error 1 (safety sub-function)]

- There is a communication error between the encoder and servo amplifier.

[AL. 067.1_ Encoder normal communication - Receive data error 1 (safety sub-function)]

☞ Page 91 [AL. 066.1_ Encoder initial communication - Receive data error 1 (safety sub-function)]

[AL. 067.2_ Encoder normal communication - Receive data error 2 (safety sub-function)]

☞ Page 91 [AL. 066.1_ Encoder initial communication - Receive data error 1 (safety sub-function)]

[AL. 067.3_ Encoder normal communication - Receive data error 3 (safety sub-function)]

☞ Page 91 [AL. 066.1_ Encoder initial communication - Receive data error 1 (safety sub-function)]

[AL. 067.4_ Encoder normal communication - Receive data error 4 (safety sub-function)]

☞ Page 91 [AL. 066.1_ Encoder initial communication - Receive data error 1 (safety sub-function)]

[AL. 067.7_ Encoder normal communication - Transmission data error 1 (safety sub-function)]

☞ Page 91 [AL. 066.1_ Encoder initial communication - Receive data error 1 (safety sub-function)]

[AL. 068_STO diagnosis error]

- An error was detected in the STO input signal.



[AL. 068.1_STO signal mismatch error]

Cause	Check/action method	Model
1. STO1 or STO2 is input incorrectly.	Check that STO1 and STO2 of the CN8 connector are wired correctly. Refer to "USING STO FUNCTION" in the following manuals. <ul style="list-style-type: none"> ☞MR-J5 User's Manual (Hardware) ☞MR-J5D User's Manual (Hardware) 	[G] [B] [A]
2. The input status of STO1 and STO2 are different.	If the on/off status of STO1 and STO2 are different, create the same input status for STO1 and STO2.	
3. The setting of [Pr. PF18 STO diagnosis error detection time] is incorrect.	Set a longer time in the servo parameter setting, then check the repeatability. If the error does not repeat, review the setting value of the servo parameter.	
4. The STO circuit has malfunctioned.	Replace the servo amplifier.	
5. There is a problem with the surrounding environment.	Check the noise, ambient temperature, and other conditions, and implement appropriate countermeasures for the cause. If there is noise, take countermeasures to reduce the noise. Refer to "Noise reduction techniques" in the following manuals. <ul style="list-style-type: none"> ☞MR-J5 User's Manual (Hardware) ☞MR-J5D User's Manual (Hardware) 	

[AL. 069_Command error]

- When the software limit was activated, the command position exceeded 32 bits (-2147483648 to 2147483647).
- When the software limit was activated, the command position exceeded 30 bits (-536870912 to 536870911) from the value that was set.
- The command position exceeded 30 bits (-536870912 to 536870911) from the position which was detected after detecting LSP (Forward rotation stroke end) or LSN (Reverse rotation stroke end).
- The command position exceeded 30 bits (-536870912 to 536870911) from the position that was detected after detecting FLS (Upper stroke limit) or RLS (Lower stroke limit).



[AL. 069.1_Forward rotation-side software limit detection - Command excess error]

Cause	Check/action method	Model
1. The command position exceeded 32 bits when the software limit was activated.	Check if the command is set for a position which exceeds 32 bits. Set the command position correctly.	[G]
2. The command position has exceeded 30 bits from the software limit setting value.	Check the software limit. [Pr. PT15 Software position limit +] [Pr. PT17 Software position limit -]	
3. The controller has malfunctioned.	Replace the controller.	
4. There is a problem with the surrounding environment.	Check the noise, ambient temperature, and other conditions, and implement appropriate countermeasures for the cause. If there is noise, take countermeasures to reduce the noise. Refer to "Noise reduction techniques" in the following manuals.  MR-J5 User's Manual (Hardware)  MR-J5D User's Manual (Hardware)	

[AL. 069.2_Reverse rotation-side software limit detection - Command excess error]

 Page 94 [AL. 069.1_Forward rotation-side software limit detection - Command excess error]

[AL. 069.3_Forward rotation stroke end detection - Command excess error]

Cause	Check/action method	Model
1. The command position exceeded 30 bits from the position that was detected after detecting LSP (Forward rotation stroke end).	Review the operation pattern so that the command does not exceed 30 bits.	[G]
2. The forward rotation stroke limit switch is not connected to LSP (Forward rotation stroke end).	Check if the limit switch is connected correctly.	
3. The controller has malfunctioned.	Replace the controller.	
4. There is a problem with the surrounding environment.	Check the noise, ambient temperature, and other conditions, and implement appropriate countermeasures for the cause. If there is noise, take countermeasures to reduce the noise. Refer to "Noise reduction techniques" in the following manuals.  MR-J5 User's Manual (Hardware)  MR-J5D User's Manual (Hardware)	

[AL. 069.4_Reverse rotation stroke end detection - Command excess error]

Cause	Check/action method	Model
1. The command position exceeded 30 bits from the position which was detected after detecting LSN (Reverse rotation stroke end).	Review the operation pattern so that the command does not exceed 30 bits.	[G]
2. The reverse rotation stroke limit switch is not connected to LSN (Reverse rotation stroke end).	Check if the limit switch is connected correctly.	
3. The controller has malfunctioned.	Replace the controller.	
4. There is a problem with the surrounding environment.	Check the noise, ambient temperature, and other conditions, and implement appropriate countermeasures for the cause. If there is noise, take countermeasures to reduce the noise. Refer to "Noise reduction techniques" in the following manuals. <ul style="list-style-type: none"> ☐MR-J5 User's Manual (Hardware) ☐MR-J5D User's Manual (Hardware) 	

[AL. 069.5_Upper stroke limit detection - Command excess error]

Cause	Check/action method	Model
1. The command position exceeded 30 bits from the position which was detected after detecting FLS (Upper stroke limit).	Review the operation pattern so that the command does not exceed 30 bits.	[G]
2. The upper stroke limit switch is not wired or the switch is positioned incorrectly.	Check if the limit switch is connected correctly or if the switch is positioned incorrectly.	
3. There is a problem with the surrounding environment.	Check the noise, ambient temperature, and other conditions, and implement appropriate countermeasures for the cause. If there is noise, take countermeasures to reduce the noise. Refer to "Noise reduction techniques" in the following manuals. <ul style="list-style-type: none"> ☐MR-J5 User's Manual (Hardware) ☐MR-J5D User's Manual (Hardware) 	
4. The controller has malfunctioned.	Replace the controller.	





[AL. 069.6_Lower stroke limit detection - Command excess error]

Cause	Check/action method	Model
1. The command position exceeded 30 bits from the position which was detected after detecting RLS (Lower stroke limit).	Review the operation pattern so that the command does not exceed 30 bits.	[G]
2. The lower stroke limit switch is not wired or the switch is positioned incorrectly.	Check if the limit switch is connected correctly or if the switch is positioned incorrectly.	
3. There is a problem with the surrounding environment.	Check the noise, ambient temperature, and other conditions, and implement appropriate countermeasures for the cause. If there is noise, take countermeasures to reduce the noise. Refer to "Noise reduction techniques" in the following manuals. <ul style="list-style-type: none"> ☐MR-J5 User's Manual (Hardware) ☐MR-J5D User's Manual (Hardware) 	
4. The controller has malfunctioned.	Replace the controller.	

[AL. 070_Load-side encoder initial communication error 1]

- There is a communication error between the load-side encoder and servo amplifier.



[AL. 070.1_Load-side encoder initial communication - Receive data error 1]

Cause	Check/action method	Model
1. There is a problem with the load-side encoder cable.	Check if the load-side encoder cable has been disconnected, incorrectly wired, or has shorted. If there is a problem with the cable, replace or repair the cable.	[G] [B] [A]
2. If an A/B/Z-phase differential output type encoder is being used, the servo amplifier is not compatible with the A/B/Z-phase differential output type encoder.	Check if the servo amplifier is compatible with the A/B/Z-phase differential output type encoder. Refer to "Compatible encoder list" in the following manual.  MR-J5 Partner's Encoder User's Manual	
3. If an A/B/Z-phase differential output type encoder is being used, the connection with the encoder is incorrect.	Check if the wiring of the A/B/Z-phase differential output type encoder is correct. Check if the encoder is wired to PSEL. Refer to "A/B/Z-phase differential output type encoder" in the following manual.  MR-J5 Partner's Encoder User's Manual	
4. The servo amplifier has malfunctioned.	Replace the servo amplifier.	
5. The load-side encoder has malfunctioned.	Replace the load-side encoder.	
6. There is a problem with the surrounding environment.	Check the noise, ambient temperature, and other conditions, and implement appropriate countermeasures for the cause. If there is noise, take countermeasures to reduce the noise. Refer to "Noise reduction techniques" in the following manuals.  MR-J5 User's Manual (Hardware)  MR-J5D User's Manual (Hardware)	



[AL. 070.2_Load-side encoder initial communication - Receive data error 2]

 Page 96 [AL. 070.1_Load-side encoder initial communication - Receive data error 1]

[AL. 070.3_Load-side encoder initial communication - Receive data error 3]

Cause	Check/action method	Model
1. For a multi-axis servo amplifier, unused axes have not been disabled.	Set the axis not used to disabled with disabling control axis switch (SW3-2/ SW3-3/SW3-4).	[G] [B]
2. The load-side encoder cable is disconnected.	Check if the load-side encoder cable is connected correctly.	[G] [B] [A]
3. There is a problem with the load-side encoder cable.	Check if the load-side encoder cable has been disconnected or has shorted. If there is a problem with the load-side encoder cable, replace or repair the cable.	
4. When an external power supply was used for the load-side encoder, the voltage of the external power supply became unstable.	Review the power supply capacity and the voltage of the external power supply.	
5. The servo parameter settings for the communication method are incorrect. This does not apply to multi-axis servo amplifiers.	Set the servo parameter according to the encoder cable communication method (two-wire type/four-wire type). [G] [B]: [Pr. PC26.3 Load-side encoder cable communication method selection] [A]: [Pr. PC44.3 Load-side encoder cable communication method selection]	
6. If an A/B/Z-phase differential output type encoder is being used, the connection with the encoder is incorrect.	Check if the wiring of the A/B/Z-phase differential output type encoder is correct. Check if the encoder is wired to PSEL. Refer to "A/B/Z-phase differential output type encoder" in the following manual.  MR-J5 Partner's Encoder User's Manual	
7. When using a four-wire type linear encoder, the servo amplifier is not compatible with the four-wire type linear encoder.	Check if the servo amplifier is compatible with the four-wire type linear encoder. Refer to "Parts identification" in the User's Manual (Introduction).	
8. The servo amplifier has malfunctioned.	Replace the servo amplifier.	
9. The load-side encoder has malfunctioned.	Replace the load-side encoder.	
10. There is a problem with the surrounding environment.	Check the noise, ambient temperature, and other conditions, and implement appropriate countermeasures for the cause. If there is noise, take countermeasures to reduce the noise. Refer to "Noise reduction techniques" in the following manuals.  MR-J5 User's Manual (Hardware)  MR-J5D User's Manual (Hardware)	
11. Values of the servo parameters for manufacturer setting have been changed.	Set the servo parameters for manufacturer setting to the initial values.	[G]

[AL. 070.5_Load-side encoder initial communication - Transmission data error 1]

Cause	Check/action method	Model
1. If an A/B/Z-phase differential output type encoder is being used, the wiring of the encoder is incorrect.	Check if the A/B-phase pulse signals (PA, PAR, PB, and PBR) of the encoder cable have been disconnected or have shorted. Refer to "A/B/Z-phase differential output type encoder" in the following manual.  MR-J5 Partner's Encoder User's Manual	[G] [B] [A]
2. There is a problem with the load-side encoder cable.	 Page 96 [AL. 070.1_Load-side encoder initial communication - Receive data error 1]	
3. The servo amplifier has malfunctioned.		
4. The load-side encoder has malfunctioned.		
5. There is a problem with the surrounding environment.		

[AL. 070.6_Load-side encoder initial communication - Transmission data error 2]

Cause	Check/action method	Model
1. If an A/B/Z-phase differential output type encoder is being used, the wiring of the encoder is incorrect.	Check if the Z-phase pulse signals (PZ and PZR) of the encoder cable have been disconnected or have shorted. Refer to "A/B/Z-phase differential output type encoder" in the following manual. MR-J5 Partner's Encoder User's Manual	[G] [B] [A]
2. There is a problem with the load-side encoder cable.	Page 96 [AL. 070.1_Load-side encoder initial communication - Receive data error 1]	
3. The servo amplifier has malfunctioned.		
4. The load-side encoder has malfunctioned.		
5. There is a problem with the surrounding environment.		

[AL. 070.7_Load-side encoder initial communication - Transmission data error 3]

Page 96 [AL. 070.1_Load-side encoder initial communication - Receive data error 1]

[AL. 070.A_Load-side encoder initial communication - Process error 1]

Cause	Check/action method	Model
1. The servo amplifier has malfunctioned.	Replace the servo amplifier.	[G]
2. The load-side encoder has malfunctioned.	Replace the load-side encoder.	[B] [A]
3. There is a problem with the surrounding environment.	Check the noise, ambient temperature, and other conditions, and implement appropriate countermeasures for the cause. If there is noise, take countermeasures to reduce the noise. Refer to "Noise reduction techniques" in the following manuals. MR-J5 User's Manual (Hardware) MR-J5D User's Manual (Hardware)	

[AL. 070.B_Load-side encoder initial communication - Process error 2]

Page 96 [AL. 070_Load-side encoder initial communication error 1]

[AL. 070.C_Load-side encoder initial communication - Process error 3]

Page 96 [AL. 070_Load-side encoder initial communication error 1]

[AL. 070.D_Load-side encoder initial communication - Process error 4]

Page 96 [AL. 070_Load-side encoder initial communication error 1]

[AL. 070.E_Load-side encoder initial communication - Process error 5]

Page 96 [AL. 070_Load-side encoder initial communication error 1]

[AL. 070.F_Load-side encoder initial communication - Process error 6]

Page 96 [AL. 070_Load-side encoder initial communication error 1]

[AL. 071_Load-side encoder normal communication error 1]

- There is a communication error between the load-side encoder and servo amplifier.

[AL. 071.1_Load-side encoder normal communication - Receive data error 1]

Cause	Check/action method	Model
1. There is a problem with the load-side encoder cable.	Check if the encoder cable has been disconnected, incorrectly wired, or has shorted. If there is a problem with the encoder cable, replace or repair the cable.	[G] [B] [A]
2. The external conductor of the encoder cable is not connected to the ground plate of the connector.	Check if the external conductor of the encoder cable is connected to the ground plate of the connector. Refer to "Shield procedure of CN2, CN2A, CN2B, and CN2C side connectors" in the following manual. 📖 Rotary Servo Motor User's Manual (For MR-J5)	
3. The servo parameter settings for the communication method are incorrect. This does not apply to multi-axis servo amplifiers.	Set the servo parameter correctly according to the encoder cable communication method (two-wire type/four-wire type). [G] [B]: [Pr. PC26.3 Load-side encoder cable communication method selection] [A]: [Pr. PC44.3 Load-side encoder cable communication method selection]	
4. The servo amplifier has malfunctioned.	Replace the servo amplifier.	
5. The load-side encoder has malfunctioned.	Replace the load-side encoder.	
6. There is a problem with the surrounding environment.	Check the noise, ambient temperature, and other conditions, and implement appropriate countermeasures for the cause. If there is noise, take countermeasures to reduce the noise. Refer to "Noise reduction techniques" in the following manuals. 📖 MR-J5 User's Manual (Hardware) 📖 MR-J5D User's Manual (Hardware)	

[AL. 071.2_Load-side encoder normal communication - Receive data error 2]

📖 Page 99 [AL. 071.1_Load-side encoder normal communication - Receive data error 1]



[AL. 071.3_Load-side encoder normal communication - Receive data error 3]

Cause	Check/action method	Model
1. The Z-phase signal cannot be detected despite being on. This does not apply to multi-axis servo amplifiers.	Check if the Z-phase pulse signals (PZ and PZR) of the encoder cable have been disconnected or have shorted. Refer to the specifications provided by the encoder manufacturer or "A/B/Z-phase differential output type encoder" in the following manual. 📖 MR-J5 Partner's Encoder User's Manual	[G] [B] [A]
2. Take actions in accordance with the items shown below.		
📖 Page 99 [AL. 071.1_Load-side encoder normal communication - Receive data error 1]		



[AL. 071.4_Erroneous number of load-side Z-phase interval pulses]

Cause	Check/action method	Model
1. The number of Z-phase interval pulses is different from the value of the encoder resolution setting.	Check if [Pr. PE51 Load-side encoder resolution setting] has been set correctly.	[G] [A]

[AL. 071.5_Load-side encoder normal communication - Transmission data error 1]

Cause	Check/action method	Model
1. If an A/B/Z-phase differential output type encoder is being used, the wiring of the encoder is incorrect.	Check if the A/B-phase pulse signals (PA, PAR, PB, and PBR) of the encoder cable have been disconnected or have shorted. Refer to the specifications provided by the encoder manufacturer or "A/B/Z-phase differential output type encoder" in the following manual.  MR-J5 Partner's Encoder User's Manual	[G] [B] [A]
2. Take actions in accordance with the items shown below.  Page 99 [AL. 071.1_Load-side encoder normal communication - Receive data error 1]		

[AL. 071.6_Load-side encoder normal communication - Transmission data error 2]

Cause	Check/action method	Model
1. If an A/B/Z-phase differential output type encoder is being used, the wiring of the encoder is incorrect.	Check if the A/B-phase pulse signals (PZ and PZR) of the encoder cable have been disconnected or have shorted. Refer to the specifications provided by the encoder manufacturer or "A/B/Z-phase differential output type encoder" in the following manual.  MR-J5 Partner's Encoder User's Manual	[G] [B] [A]
2. Take actions in accordance with the items shown below.  Page 99 [AL. 071.1_Load-side encoder normal communication - Receive data error 1]		

[AL. 071.7_Load-side encoder normal communication - Transmission data error 3]

 Page 99 [AL. 071.1_Load-side encoder normal communication - Receive data error 1]

[AL. 071.C_Load-side encoder communication protocol error 1]

 Page 99 [AL. 071.1_Load-side encoder normal communication - Receive data error 1]

[AL. 071.D_Load-side encoder communication protocol error 2]

 Page 99 [AL. 071.1_Load-side encoder normal communication - Receive data error 1]

[AL. 072_Load-side encoder normal communication error 2]

- The load-side encoder detected an error signal.

[AL. 072.1_Load-side encoder data error 1]

Cause	Check/action method	Model
1. An excessive speed or acceleration was detected due to an oscillation or other factors.	Decrease the control gain, then check the repeatability. If the error does not repeat, use the encoder with a lower gain.	[G] [B] [A]
2. The load-side encoder has malfunctioned.	Replace the load-side encoder.	
3. There is a problem with the surrounding environment.	Check the noise, ambient temperature, external magnetic field, and other conditions, and implement appropriate countermeasures for the cause. If there is noise, take countermeasures to reduce the noise. Refer to "Noise reduction techniques" in the following manuals. <ul style="list-style-type: none"> ☞ MR-J5 User's Manual (Hardware) ☞ MR-J5D User's Manual (Hardware) 	

[AL. 072.2_Load-side encoder data update error]

Cause	Check/action method	Model
1. The load-side encoder has malfunctioned.	Replace the load-side encoder.	[G] [B] [A]
2. There is a problem with the surrounding environment.	Check the noise, ambient temperature, and other conditions, and implement appropriate countermeasures for the cause. If there is noise, take countermeasures to reduce the noise. Refer to "Noise reduction techniques" in the following manuals. <ul style="list-style-type: none"> ☞ MR-J5 User's Manual (Hardware) ☞ MR-J5D User's Manual (Hardware) 	

[AL. 072.3_Load-side encoder data waveform error]

☞ Page 101 [AL. 072.2_Load-side encoder data update error]

[AL. 072.4_No load-side encoder signal]

Cause	Check/action method	Model
1. A signal of the load-side encoder has not been input.	Check if the encoder cable is wired correctly.	[G] [B] [A]
2. There is a problem with the surrounding environment.	Check the noise, ambient temperature, and other conditions, and implement appropriate countermeasures for the cause. If there is noise, take countermeasures to reduce the noise. Refer to "Noise reduction techniques" in the following manuals. <ul style="list-style-type: none"> ☞ MR-J5 User's Manual (Hardware) ☞ MR-J5D User's Manual (Hardware) 	

[AL. 072.5_Load-side encoder hardware error 1]

☞ Page 101 [AL. 072.2_Load-side encoder data update error]

[AL. 072.6_Load-side encoder hardware error 2]

☞ Page 101 [AL. 072.2_Load-side encoder data update error]

[AL. 076_Load-side encoder error]

- There is an error in a parameter.

[AL. 076.2_Load-side encoder error 2]

Cause	Check/action method	Model
1. Values of the servo parameters for manufacturer setting have been changed.	Set the servo parameters for manufacturer setting to the initial values.	[G]

[AL. 076.3_Load-side encoder error 3]

Cause	Check/action method	Model
1. Values of the servo parameters for manufacturer setting have been changed.	Set the servo parameters for manufacturer setting to the initial values.	[G]

[AL. 082_Master-slave operation error 1]

- An inter-driver communication error was detected.



[AL. 082.1_Master-slave operation error 1]

☞ Page 69 [AL. 034.1_SSCNET receive data error]

[AL. 086_Network communication error]

- An error occurred in the network communication.

[AL. 086.1_Network communication error 1]

Cause	Check/action method	Model
1. A network cable is disconnected.	Check if the network cable is connected correctly. Turn off the control circuit power supply of the servo amplifier, then connect the network cable correctly.	[G]
2. The wiring of the network cable was incorrect.	Check if the connection of network cable is correct.	
3. A network cable has been disconnected.	Check for disconnection in the network cable.	
4. Devices on the network (including repeaters such as hubs) are turned off.	Check that the devices on the network are turned on.	
5. The network was disconnected by an incorrect procedure.	Check if the network was disconnected by a correct procedure for each type of network. Refer to "Disconnecting the communication" in the User's Manual (Communication function).	
6. Data transmission from the controller was interrupted for a certain time.	Check if data transmission from the controller has not been interrupted. If the data transmission has been interrupted, review the controller communication setting.	
7. The settings of the controller were incorrect.	Check the controller settings. When using CC-Link IE TSN, review communication settings such as those for increasing the transient transmission time of the controller. Alternatively, reduce the number of servo amplifiers that enter the network midway.	
8. There is a problem with the surrounding environment.	Check the noise, ambient temperature, and other conditions, and implement appropriate countermeasures for the cause. If there is noise, take countermeasures to reduce the noise. Refer to "Noise reduction techniques" in the following manuals.  MR-J5 User's Manual (Hardware)  MR-J5D User's Manual (Hardware)	
9. The servo amplifier has malfunctioned.	Replace the servo amplifier.	
10. The controller has malfunctioned.	Replace the controller.	
11. Devices on the network (including repeaters such as hubs) have malfunctioned.	Replace the devices on the network.	

[AL. 086.2_Network communication error 2]

 Page 104 [AL. 086.1_Network communication error 1]

[AL. 086.3_Network communication error 3]

 Page 104 [AL. 086.1_Network communication error 1]

[AL. 086.4_Network communication error 4]

 Page 104 [AL. 086.1_Network communication error 1]

[AL. 086.5_Network communication error 5]

 Page 104 [AL. 086.1_Network communication error 1]

[AL. 086.6_Network communication error 6]

 Page 104 [AL. 086.1_Network communication error 1]

[AL. 088_Watchdog 1]/[AL. 888_Watchdog 1]/[AL. 88888_Watchdog 1]

- The CPU or other component parts have malfunctioned.

[AL. 088.1_Watchdog 1-1]/[AL. 088_Watchdog 1-1]/[AL. 888_Watchdog 1-1]/[AL. 88888_Watchdog 1-1]

Cause	Check/action method	Model
1. There is a problem with the surrounding environment.	Check the noise, ambient temperature, and other conditions, and implement appropriate countermeasures for the cause. If there is noise, take countermeasures to reduce the noise. Refer to "Noise reduction techniques" in the following manuals. <ul style="list-style-type: none"> ☞ MR-J5 User's Manual (Hardware) ☞ MR-J5D User's Manual (Hardware) 	[G] [B] [A]
2. The servo amplifier has malfunctioned.	Replace the servo amplifier.	

[AL. 088.2_Watchdog 1-2]

☞ Page 105 [AL. 088.1_Watchdog 1-1]/[AL. 088_Watchdog 1-1]/[AL. 888_Watchdog 1-1]/[AL. 88888_Watchdog 1-1]

[AL. 088.4_Watchdog 1-4]

☞ Page 105 [AL. 088.1_Watchdog 1-1]/[AL. 088_Watchdog 1-1]/[AL. 888_Watchdog 1-1]/[AL. 88888_Watchdog 1-1]

[AL. 088.8_Watchdog 1-8]

☞ Page 105 [AL. 088.1_Watchdog 1-1]/[AL. 088_Watchdog 1-1]/[AL. 888_Watchdog 1-1]/[AL. 88888_Watchdog 1-1]

[AL. 08A_Serial communication time-out error]

- The communication between the servo amplifier and the personal computer or the controller was lost for the specified time or longer.
- There is a problem with the serial communication (Mitsubishi Electric AC servo protocol).

[AL. 08A.1_Serial communication time-out error]

Cause	Check/action method	Model
1. The communication command has not been transmitted.	Check if the command has been transmitted from the personal computer or other equipment.	[A]
2. The communication cable has been disconnected.	Replace the communication cable.	
3. The servo amplifier has malfunctioned.	Replace the servo amplifier.	

[AL. 08E_Serial communication error]

- A communication error occurred between the servo amplifier and the personal computer or the controller.
- There is a problem with the USB communication or serial communication (Mitsubishi Electric AC servo protocol).

[AL. 08E.1_Serial communication receive error]

Cause	Check/action method	Model
1. The settings of the personal computer or other equipment are incorrect.	Check the settings of the personal computer and other equipment.	[G] [B] [A]
2. There is a problem with the communication cable.	Check the communication cable, then check the repeatability.	
3. The servo amplifier has malfunctioned.	Replace the servo amplifier, then check the repeatability.	
4. There is a problem with the surrounding environment.	Check the power supply for noise. If there is noise, take countermeasures to reduce the noise. Check if the connector has shorted. Refer to "Noise reduction techniques" in the following manuals. □MR-J5 User's Manual (Hardware) □MR-J5D User's Manual (Hardware)	

[AL. 08E.2_Serial communication checksum error]

Cause	Check/action method	Model
1. The settings of the personal computer or other equipment are incorrect.	Check the settings of the personal computer and other equipment.	[G] [B] [A]

[AL. 08E.3_Serial communication character error]

Cause	Check/action method	Model
1. An unsupported character was transmitted.	Check the character code at the time of transmission. If an unsupported character was transmitted, correct the transmission data.	[G] [B] [A]
2. The communication protocol has a problem.	Check if the transmission data complies with the communication protocol.	
3. The settings of the personal computer or other equipment are incorrect.	Check the settings of the personal computer and other equipment.	

[AL. 08E.4_Serial communication command error]

Cause	Check/action method	Model
1. An unsupported command was transmitted.	Check the command at the time of transmission. If an unsupported command was transmitted, correct the transmission data.	[G] [B] [A]
2. The communication protocol has a problem.	Check if the transmission data complies with the communication protocol.	
3. The settings of the personal computer or other equipment are incorrect.	Check the settings of the personal computer and other equipment.	

[AL. 08E.5_Serial communication data number error]

Cause	Check/action method	Model
1. An unsupported data number was transmitted.	Check the data number at the time of transmission. If an unsupported data number was transmitted, correct the transmission data.	[G] [B] [A]
2. The communication protocol has a problem.	Check if the transmission data complies with the communication protocol.	
3. The settings of the personal computer or other equipment are incorrect.	Check the settings of the personal computer and other equipment.	

[AL. 08F_Two-digit alarm No. display alarm]

- A three-digit alarm is occurring.

[AL. 08F.1_Two-digit alarm No. display alarm for AL. 100 to AL. 1FF]

Cause	Check/action method	Model
1. An alarm with alarm No. in 100s ([AL. 1_ _]) is occurring.	Check the alarm number using an object that can read three-digit numbers, the servo amplifier display, or MR Configurator2, and take corrective action.	[G]

[AL. 08F.2_Two-digit alarm No. display alarm for AL. 200 to AL. 2FF]

Cause	Check/action method	Model
1. An alarm with alarm No. in 200s ([AL. 2_ _]) is occurring.	Check the alarm number using an object that can read three-digit numbers, the servo amplifier display, or MR Configurator2, and take corrective action.	[G]

[AL. 08F.3_Two-digit alarm No. display alarm for AL. 300 to AL. 3FF]

Cause	Check/action method	Model
1. An alarm with alarm No. in 300s ([AL. 3_ _]) is occurring.	Check the alarm number using an object that can read three-digit numbers, the servo amplifier display, or MR Configurator2, and take corrective action.	[G]

[AL. 08F.4_Two-digit alarm No. display alarm for AL. 400 to AL. 4FF]

Cause	Check/action method	Model
1. An alarm with alarm No. in 400s ([AL. 4_ _]) is occurring.	Check the alarm number using an object that can read three-digit numbers, the servo amplifier display, or MR Configurator2, and take corrective action.	[G]

[AL. 08F.5_Two-digit alarm No. display alarm for AL. 500 to AL. 5FF]

Cause	Check/action method	Model
1. An alarm with alarm No. in 500s ([AL. 5_ _]) is occurring.	Check the alarm number using an object that can read three-digit numbers, the servo amplifier display, or MR Configurator2, and take corrective action.	[G]

[AL. 08F.6_Two-digit alarm No. display alarm for AL. 600 to AL. 6FF]

Cause	Check/action method	Model
1. An alarm with alarm No. in 600s ([AL. 6_ _]) is occurring.	Check the alarm number using an object that can read three-digit numbers, the servo amplifier display, or MR Configurator2, and take corrective action.	[G]

[AL. 08F.7_Two-digit alarm No. display alarm for AL. 700 to AL. 7FF]

Cause	Check/action method	Model
1. An alarm with alarm No. in 700s ([AL. 7_ _]) is occurring.	Check the alarm number using an object that can read three-digit numbers, the servo amplifier display, or MR Configurator2, and take corrective action.	[G]

[AL. 08F.8_Two-digit alarm No. display alarm for AL. 800 to AL. 8FF]

Cause	Check/action method	Model
1. An alarm with alarm No. in 800s ([AL. 8_ _]) is occurring.	Check the alarm number using an object that can read three-digit numbers, the servo amplifier display, or MR Configurator2, and take corrective action.	[G]

[AL. 08F.9_Two-digit alarm No. display alarm for AL. 900 to AL. 9FF]

Cause	Check/action method	Model
1. An alarm with alarm No. in 900s ([AL. 9_]) is occurring.	Check the alarm number using an object that can read three-digit numbers, the servo amplifier display, or MR Configurator2, and take corrective action.	[G]

[AL. 08F.A_Two-digit alarm No. display alarm for AL. A00 to AL. AFF]

Cause	Check/action method	Model
1. An alarm with alarm No. in A00s ([AL. A_]) is occurring.	Check the alarm number using an object that can read three-digit numbers, the servo amplifier display, or MR Configurator2, and take corrective action.	[G]

[AL. 08F.B_Two-digit alarm No. display alarm for AL. B00 to AL. BFF]

Cause	Check/action method	Model
1. An alarm with alarm No. in B00s ([AL. B_]) is occurring.	Check the alarm number using an object that can read three-digit numbers, the servo amplifier display, or MR Configurator2, and take corrective action.	[G]

[AL. 08F.C_Two-digit alarm No. display alarm for AL. C00 to AL. CFF]

Cause	Check/action method	Model
1. An alarm with alarm No. in C00s ([AL. C_]) is occurring.	Check the alarm number using an object that can read three-digit numbers, the servo amplifier display, or MR Configurator2, and take corrective action.	[G]

[AL. 08F.D_Two-digit alarm No. display alarm for AL. D00 to AL. DFF]

Cause	Check/action method	Model
1. An alarm with alarm No. in D00s ([AL. D_]) is occurring.	Check the alarm number using an object that can read three-digit numbers, the servo amplifier display, or MR Configurator2, and take corrective action.	[G]

[AL. 08F.E_Two-digit alarm No. display alarm for AL. E00 to AL. EFF]

Cause	Check/action method	Model
1. An alarm with alarm No. in E00s ([AL. E_]) is occurring.	Check the alarm number using an object that can read three-digit numbers, the servo amplifier display, or MR Configurator2, and take corrective action.	[G]

[AL. 08F.F_Two-digit alarm No. display alarm for AL. F00 to AL. FFF]

Cause	Check/action method	Model
1. An alarm with alarm No. in F00s ([AL. F_]) is occurring.	Check the alarm number using an object that can read three-digit numbers, the servo amplifier display, or MR Configurator2, and take corrective action.	[G]

[AL. 090_Homing incomplete warning]

- Homing has not been finished.
- Homing did not complete properly.
- Homing was executed with the Z-phase unpassed.

[AL. 090.1_Homing incomplete]

Cause	Check/action method	Model
1. Homing has not been executed.	Check if homing was executed. If homing was not executed, execute homing.	[G]
2. Positioning operation was executed without homing after [AL. 025 Absolute position erased] occurred in the absolute position detection system.	Execute homing after dealing with [AL. 025]. Refer to "Homing mode (hm)" in the following manual. □□MR-J5 User's Manual (Function)	
3. Homing completion 2 (S_ZP2) turned off after homing was executed.	Remove the causes that turned off homing completion 2 (S_ZP2), then execute homing again. Refer to "Homing method list" in the following manual. □□MR-J5 User's Manual (Function)	
4. [AL. 069 Command error] occurred.	Execute homing after dealing with [AL. 069]. Refer to "Homing mode (hm)" in the following manual. □□MR-J5 User's Manual (Function)	

[AL. 090.2_Homing abnormal termination]

Cause	Check/action method	Model
1. The proximity dog is not connected to DOG.	Check if the proximity dog is connected correctly. Check the status of the input signal on the I/O monitor screen of MR Configurator2.	[G]
2. The stroke limit was detected after homing was started.	Check if the stroke limit switch is connected to the servo amplifier correctly, or check if the stroke limit has been reached.	
3. Deceleration from the homing speed to the creep speed was not possible.	There is a possibility that the proximity dog turned off before deceleration from the homing speed to the creep speed was completed. Review the dog position, or review the parameter values of the homing speed, the creep speed, and the travel distance after proximity dog.	

[AL. 090.5_Z-phase unpassed]

Cause	Check/action method	Model
1. Homing was executed while the servo motor did not pass the Z-phase.	Review the homing start position and the proximity dog position so that the servo motor passes the Z-phase signal until the proximity dog turns off after homing started.	[G]
2. The Z-phase signal was not detected normally.	Check if the Z-phase signal of the servo motor or linear encoder was detected normally. If a linear encoder is being used, replace the linear encoder. If a rotary servo motor or direct drive motor is being used, replace the servo motor.	

[AL. 091_Servo amplifier overheat warning]

- The temperature inside of the servo amplifier has reached a warning level.

[AL. 091.1_Main circuit device overheat warning]

Cause	Check/action method	Model
1. The ambient temperature of the servo amplifier exceeded the specified value (60 °C).	Lower the ambient temperature.	[G] [B] [A]
2. The servo amplifier does not meet the specifications of close mounting.	Check the specifications of close mounting. Refer to "Mounting direction and clearances" in the following manual. □MR-J5 User's Manual (Hardware)	
3. Cooling performance has deteriorated due to clogging of the heat sink and other factors.	Remove causes such as the clogging of the heat sink.	

[AL. 092_Battery cable disconnection warning]

- The battery voltage for the absolute position detection system has decreased.

[AL. 092.1_Encoder battery cable disconnection warning]

Cause	Check/action method	Model
1. The MR-BAT6V1SET(-A) battery or MR-BT6VCASE battery case is not connected to CN4.	Check if the battery is connected correctly.	[G] [B] [A]
2. The battery cable has been disconnected.	Check if the battery cable has malfunctioned.	
3. The battery voltage is too low. The battery is exhausted.	Check the battery voltage with a tester. If the voltage is lower than 3.1 V DC, replace the battery.	
4. There is a problem with the encoder cable.	Check if the BAT wiring of the encoder cable has been disconnected or has shorted.	
5. The servo amplifier has malfunctioned.	Replace the servo amplifier, then check the repeatability.	
6. The encoder has malfunctioned.	Replace the servo motor, then check the repeatability.	

[AL. 092.2_Load-side encoder battery cable disconnection warning]

☞ Page 112 [AL. 092.1_Encoder battery cable disconnection warning]

[AL. 092.3_Battery degradation]

Cause	Check/action method	Model
1. The battery voltage is too low. The battery is exhausted.	Check the battery voltage with a tester. If the voltage is lower than 3.0 V DC, replace the battery.	[G] [B] [A]
2. The battery has malfunctioned.	Replace the battery, then check the repeatability.	

[AL. 093_ABS data transfer warning]

- ABS data was not transferred.

1

[AL. 093.1_Magnetic pole detection incomplete warning at ABS data transfer request]

Cause	Check/action method	Model
1. The Z-phase was not turned on at servo-on.	Check if the position within one-revolution is "0". If the position within one-revolution is "0" (with the Z-phase unpassed), turn on the Z-phase, then disable the magnetic pole detection. Perform homing again.	[A]
2. The magnetic pole detection was executed.	If the ABS data was transferred during a magnetic pole detection, disable the magnetic pole detection. Afterwards, cycle SON (Servo-on), then transfer the ABS data.	

[AL. 095_STO warning]

- STO input signal turned off during servo motor stop.

[AL. 095.1_STO1 off detection]

Cause	Check/action method	Model
1. STO1 was not input correctly.	Refer to the wiring diagram and correct the wiring. When the STO function is not used, install the short-circuit connector attached to the servo amplifier on CN8. Refer to "USING STO FUNCTION" in the following manuals. <input type="checkbox"/> MR-J5 User's Manual (Hardware) <input type="checkbox"/> MR-J5D User's Manual (Hardware)	[G] [B] [A]
2. While detection by [AL. 063 STO timing error] has been enabled, STO1 was turned off (enabled) under the following speed conditions. <ul style="list-style-type: none"> • Rotary servo motor speed: 50 r/min or lower • Linear servo motor speed: 50 mm/s or lower • Direct drive motor speed: 5 r/min or lower 	Turn on STO1 (disabled). Review the settings of "STO timing error selection" with the following parameters. [G] [B]: [Pr. PF06.1 STO timing error selection] [A]: [Pr. PF09.1 STO timing error selection]	
3. The servo amplifier has malfunctioned.	Replace the servo amplifier, then check the repeatability.	
4. STO is off (enabled) when a safety component such as the safety logic unit MR-J3-D05 is being used. The safety component has a problem.	Take corrective actions according to the troubleshooting for the safety component being used.	

[AL. 095.2_STO2 off detection]

Cause	Check/action method	Model
1. STO2 was not input correctly.	Refer to the wiring diagram and correct the wiring. When the STO function is not used, install the short-circuit connector attached to the servo amplifier on CN8. Refer to "USING STO FUNCTION" in the following manuals. <input type="checkbox"/> MR-J5 User's Manual (Hardware) <input type="checkbox"/> MR-J5D User's Manual (Hardware)	[G] [B] [A]
2. While detection by [AL. 063 STO timing error] has been enabled, STO2 was turned off (enabled) under the following speed conditions. <ul style="list-style-type: none"> • Rotary servo motor speed: 50 r/min or lower • Linear servo motor speed: 50 mm/s or lower • Direct drive motor speed: 5 r/min or lower 	Turn on STO2 (disabled). Review the settings of "STO timing error selection" with the following parameters. [G] [B]: [Pr. PF06.1 STO timing error selection] [A]: [Pr. PF09.1 STO timing error selection]	
3. The servo amplifier has malfunctioned.	Replace the servo amplifier, then check the repeatability.	

[AL. 096_Home position setting warning]

- Homing failed.

[AL. 096.1_In-position warning at homing]

Cause	Check/action method	Model
1. During homing, INP (In-position) did not turn on within the specified time.	Adjust gains so that the droop pulses are set within the In-position range. Remove the cause of droop pulse occurrence, then perform homing.	[G] [B] [A]

[AL. 096.2_Command input warning at homing]

Cause	Check/action method	Model
1. A command was input during homing.	Ensure that a command is not input during homing.	[G] [B]
2. Creep speed is too high.	Decelerate the creep speed, then perform homing.	[A]
3. During homing, the servo motor shaft was rotated by an external force or the moving part of the linear servo motor was moved by an external force.	Check the actual position of the servo motor. When an external force rotates the servo motor or moves the linear servo motor, perform homing after the servo motor stops.	[G]

[AL. 096.3_Servo off warning at homing]

Cause	Check/action method	Model
1. An attempt to execute homing was made during servo-off.	After servo-on, execute homing.	[A]

[AL. 096.4_Magnetic pole detection incomplete warning at homing]

Cause	Check/action method	Model
1. Z-phase was not turned on after servo-on.	Rotate the direct drive motor to turn on the Z-phase, then perform homing.	[G] [A]

[AL. 098_Software position limit warning]

- The software position limit set by servo parameters has been reached.

[AL. 098.1_Forward rotation-side software stroke limit reached]

Cause	Check/action method	Model
1. A software position limit has been reached.	Check the operation pattern.	[G]
2. A software position limit has been reached in the JOG operation mode.	Operate the system in the range of the software position limit. Adjust the parameters or objects related to the JOG operation mode as necessary.	
3. The software position limit was set within the actual operation range.	Check if [Pr. PT15 Software position limit +] and [Pr. PT17 Software position limit -] are set correctly.	

[AL. 098.2_Reverse rotation-side software stroke limit reached]

☞ Page 116 [AL. 098.1_Forward rotation-side software stroke limit reached]

[AL. 099_Stroke limit warning]

- The stroke limit signal is off.

[AL. 099.1_Forward rotation stroke end off]

Cause	Check/action method	Model
1. The forward rotation stroke limit switch is not connected to LSP.	Check if the limit switch is connected correctly. The status of the input signal can be confirmed on the I/O monitor screen of MR Configurator2.	[G] [A]
2. The forward rotation stroke end was exceeded during driving.	Check the operation pattern.	
3. The limit switch has malfunctioned. The sensor has not been adjusted correctly.	Check if the limit switch is functioning correctly or if the sensor has been adjusted correctly.	

[AL. 099.2_Reverse rotation stroke end off]

Cause	Check/action method	Model
1. The reverse rotation stroke limit switch is not connected to LSN.	Check if the limit switch is connected correctly. The status of the input signal can be confirmed on the I/O monitor screen of MR Configurator2.	[G] [A]
2. The reverse rotation stroke end was exceeded during driving.	Check the operation pattern.	
3. The limit switch has malfunctioned. The sensor has not been adjusted correctly.	Check if the limit switch is functioning correctly or if the sensor has been adjusted correctly.	

[AL. 099.4_Upper stroke limit off]

Cause	Check/action method	Model
1. The upper stroke limit switch is not connected to FLS of the controller.	Check if the limit switch is connected correctly. The status of the input signal can be confirmed on the I/O monitor screen of MR Configurator2.	[G]
2. The upper stroke limit was exceeded during driving.	Check the operation pattern.	
3. The limit switch has malfunctioned. The sensor has not been adjusted correctly.	Check if the limit switch is functioning correctly or if the sensor has been adjusted correctly.	

[AL. 099.5_Lower stroke limit off]

Cause	Check/action method	Model
1. The lower stroke limit switch is not connected to RLS of the controller.	Check if the limit switch is connected correctly. The status of the input signal can be confirmed on the I/O monitor screen of MR Configurator2.	[G]
2. The lower stroke limit was exceeded during driving.	Check the operation pattern.	
3. The limit switch has malfunctioned. The sensor has not been adjusted correctly.	Check if the limit switch is functioning correctly or if the sensor has been adjusted correctly.	

[AL. 099.6_Forced stop deceleration based on forward rotation stroke end]

☞ Page 117 [AL. 099.1_Forward rotation stroke end off]

[AL. 099.7_Forced stop deceleration based on reverse rotation stroke end]

☞ Page 117 [AL. 099.2_Reverse rotation stroke end off]

[AL. 099.8_Upper stroke limit off 2]

☞ Page 117 [AL. 099.4_Upper stroke limit off]

[AL. 099.9_Lower stroke limit off 2]

☞ Page 117 [AL. 099.5_Lower stroke limit off]

[AL. 09B_ Excessive error warning]

- Droop pulses exceeded the warning occurrence level.

[AL. 09B.1_ Excessive droop pulse 1 warning]

Cause	Check/action method	Model
1. The servo motor power cable was disconnected.	Repair or replace the servo motor power cable.	[G] [B] [A]
2. The connection of the servo motor is incorrect.	Check the U/V/W wiring. Refer to "Example power circuit connections" in the following manuals. <ul style="list-style-type: none"> □ MR-J5 User's Manual (Hardware) □ MR-J5D User's Manual (Hardware) 	
3. The connection of the encoder cable is incorrect.	Check if the encoder cable is connected correctly.	
4. The torque limit has been enabled.	If the torque has been limited, increase the torque limit value.	
5. A moving part collided against the machine.	Review the operation pattern to avoid collision.	
6. The torque is insufficient.	Check the peak load ratio. If the torque is saturated, reduce the load or review the operation pattern. Alternatively, replace the servo motor with a larger-capacity servo motor.	
7. The power supply voltage has dropped.	If the bus voltage is too low, review the power supply voltage and power supply capacity.	
8. Acceleration/deceleration time constant is insufficient.	Set a longer acceleration/deceleration time constant, then check the repeatability.	
9. The position control gain is too small.	Increase the value of [Pr. PB08 Position control gain].	
10. The servo motor shaft was rotated by an external force or the moving part of the linear servo motor was moved by an external force.	Measure the actual position under the servo-lock status. When an external force rotates the servo motor or moves the linear servo motor, review the machine.	
11. The encoder or linear encoder has malfunctioned.	Replace the servo motor or linear encoder.	

[AL. 09B.3_ Excessive droop pulse 2 warning]

☞ Page 119 [AL. 09B.1_ Excessive droop pulse 1 warning]

[AL. 09B.4_ Excessive error warning during 0 torque limit]

Cause	Check/action method	Model
1. The torque limit value is 0.	Do not input a command when the torque limit value is 0.	[G] [B] [A]

[AL. 09C_Converter warning]

- A warning occurred in the converter unit during servo-on.

[AL. 09C.1_Converter unit warning]

Cause	Check/action method	Model
1. A warning occurred in the converter unit during servo-on.	Check the warning of the converter unit, and take corrective action in accordance with "CONVERTER UNIT TROUBLESHOOTING" in the following manual.  MR-CV Power Regeneration Converter Unit User's Manual	[G]

[AL. 09E_Network warning]

- An error exists in the network data reception.
- An error exists in the network settings.

[AL. 09E.2_Communication cycle setting warning]

Cause	Check/action method	Model
1. The communication cycle was set to 31.25 μ s.	For a 1-axis servo amplifier, set [Pr. PA01.7 High speed mode] to "1". For a multi-axis servo amplifier, set the communication cycle to 62.5 μ s or longer.	[G]
2. An unsupported communication cycle was set.	Review the settings on the master side.	
3. The communication cycle was set to 250 μ s or less while the communication speed was set to 100 Mbps for CC-Link IE TSN.	Change the communication cycle to 500 μ s or more, or change the communication speed of the controller and the servo amplifier to 1 Gbps.	
4. The communication cycle for CC-Link IE TSN Class A has been set to a lower value than 500 μ s or a higher value than 500 ms.	For CC-Link IE TSN Class A, set the communication cycle to a value between 500 μ s and 500 ms inclusive.	

[AL. 09E.3_Number of cyclic points warning]

Cause	Check/action method	Model
1. A value larger than the maximum size was set to the cyclic points number.	Change the communication cycle, or review the mapping. For the maximum number of cyclic points, refer to "Communication specifications" in the User's Manual (Communication Function).	[G]

[AL. 09E.4_Parameter file warning]

Cause	Check/action method	Model
1. There is an error on the parameter file of the parameter automatic setting.	Replace the parameter automatic setting file.	[G]
2. The processing of the automatic parameter setting was interrupted.	 Page 104 [AL. 086.1_Network communication error 1]	

[AL. 09E.5_Cyclic communication setting warning]

Cause	Check/action method	Model
1. An unsupported communication cycle was set.	Review the settings on the master side.	[G]

[AL. 09E.6_IP address setting warning]

Cause	Check/action method	Model
1. Duplication of an IP address has been detected.	To ensure that there is no duplication of IP addresses, review [Pr. NPA01 IP address setting], [Pr. NPA02 IP address], and the rotary switch setting. When the command interface is EtherNet/IP, review the settings to ensure that there is no duplication of IP addresses. For details, refer to "STARTUP" in the following manual.  MR-J5-G-N1/MR-J5W-G-N1 User's Manual (Communication Function)	[G]

[AL. 09E.7_Parameter unreflected warning]

Cause	Check/action method	Model
1. Parameter automatic setting was performed for the parameters that require power cycling.	Cycle the power.	[G]

[AL. 09E.8_Master station error detection warning]

Cause	Check/action method	Model
1. An error was detected on the master side.	Check the status on the master side.	[G]

[AL. 09E.9_Control mode setting warning]

Cause	Check/action method	Model
1. An unsupported control mode was selected.	Check the synchronous/asynchronous mode and the control mode. Refer to "Availability of synchronous mode in control mode" in the User's Manual (Communication Function).	[G]
2. A function of an unsupported control mode was selected.	When the cyclic synchronous pressure mode is used, set [Pr. PW12.2 Forward/reverse-side stop function] to "1" or "2", and disable the reverse-side stop function.	

[AL. 09E.A_Communication cycle setting warning]

Cause	Check/action method	Model
1. Servo parameter settings primarily for the control mode and functions that are not supported by the network communication cycle currently in use have been selected.	Check the servo parameters and change the communication cycle to one that is compatible with the set control mode and functions. For the function restrictions of the network communication cycle, refer to "Restrictions on the MR-J5_ -_G_" in the User's Manual (Introduction).	[G]
2. The servo amplifier is set to use a communication cycle of 31.25 μ s when the network communication cycle is 1.5 ms, 2.5 ms, 3 ms, 3.5 ms, 4.5 ms, 5 ms, 5.5 ms, 6 ms, 6.5 ms, 7 ms, or 7.5 ms.	Set [Pr. PA01.7 High speed mode] to "0" to use a network communication cycle of 1.5 ms, 2.5 ms, 3 ms, 3.5 ms, 4.5 ms, 5 ms, 5.5 ms, 6 ms, 6.5 ms, 7 ms, or 7.5 ms.	
3. Values of the servo parameters for manufacturer setting have been changed.	Set the servo parameters for manufacturer setting to the initial values.	

[AL. 09E.B_PDO setting warning]

Cause	Check/action method	Model
1. The PDO setting for FSoE communication is incorrect.	Review the PDO setting for FSoE communication.	[G]

[AL. 09F_Battery warning]

- The battery voltage for the absolute position detection system has decreased.

[AL. 09F.1_Low battery]

Cause	Check/action method	Model
1. The battery is not connected to CN4.	Check if the battery is connected correctly.	[G]
2. The battery voltage is too low. The battery is exhausted.	Check the voltage of the battery with a tester, and if the voltage is lower than 4.9 V DC, replace the battery.	[B] [A]
3. There is a problem with the encoder cable.	Check if the BAT wiring of the encoder cable has been disconnected or has shorted.	
4. The servo amplifier has malfunctioned.	Replace the servo amplifier, then check the repeatability.	
5. The encoder has malfunctioned.	Replace the servo motor, then check the repeatability.	

[AL. 09F.2_Battery degradation warning]

Cause	Check/action method	Model
1. The absolute position storage unit is not connected.	Check if the absolute position storage unit is connected correctly.	[G] [B] [A]
2. The battery voltage is too low. The battery is exhausted.	Replace the battery.	

[AL. 0E0_ Excessive regeneration warning]

- [AL. 030.1 Regenerative heat error] may occur.

[AL. 0E0.1_ Excessive regeneration warning]

Cause	Check/action method	Model
1. The regenerative load ratio exceeded 85 %.	 Page 63 [AL. 030.1_Regenerative heat error]	[G] [B] [A]

[AL. 0E1_Overload warning 1]

- [AL. 050 Overload 1] or [AL. 051 Overload 2] may occur.

[AL. 0E1.1_Thermal overload warning 1 during operation]

Cause	Check/action method	Model
1. The load was over 85 % of the alarm trigger level of [AL. 050.1 Thermal overload error 1 during operation].	☞ Page 82 [AL. 050.1_Thermal overload error 1 during operation]	[G] [B] [A]

[AL. 0E1.2_Thermal overload warning 2 during operation]

Cause	Check/action method	Model
1. The load was over 85 % of the alarm trigger level of [AL. 050.2 Thermal overload error 2 during operation].	☞ Page 82 [AL. 050.2_Thermal overload error 2 during operation]	[G] [B] [A]

[AL. 0E1.3_Thermal overload warning 3 during operation]

Cause	Check/action method	Model
1. The load was over 85 % of the alarm trigger level of [AL. 051.1 Thermal overload error 3 during operation].	☞ Page 84 [AL. 051.1_Thermal overload error 3 during operation]	[G] [B] [A]

[AL. 0E1.4_Thermal overload warning 4 during operation]

Cause	Check/action method	Model
1. The load was over 85 % of the alarm trigger level of [AL. 050.3 Thermal overload error 4 during operation].	☞ Page 82 [AL. 050.3_Thermal overload error 4 during operation]	[G] [B] [A]

[AL. 0E1.5_Thermal overload warning 1 during a stop]

Cause	Check/action method	Model
1. The load was over 85 % of the alarm trigger level of [AL. 050.4 Thermal overload error 1 during a stop].	☞ Page 83 [AL. 050.4_Thermal overload error 1 during a stop]	[G] [B] [A]

[AL. 0E1.6_Thermal overload warning 2 during a stop]

Cause	Check/action method	Model
1. The load was over 85 % of the alarm trigger level of [AL. 050.5 Thermal overload error 2 during a stop].	☞ Page 83 [AL. 050.5_Thermal overload error 2 during a stop]	[G] [B] [A]

[AL. 0E1.7_Thermal overload warning 3 during a stop]

Cause	Check/action method	Model
1. The load was over 85 % of the alarm trigger level of [AL. 051.2 Thermal overload error 3 during a stop].	☞ Page 84 [AL. 051.2_Thermal overload error 3 during a stop]	[G] [B] [A]

[AL. 0E1.8_Thermal overload warning 4 during a stop]

Cause	Check/action method	Model
1. The load was over 85 % of the alarm trigger level of [AL. 050.6 Thermal overload error 4 during a stop].	 Page 83 [AL. 050.6_Thermal overload error 4 during a stop]	[G] [B] [A]

[AL. 0E2_Servo motor overheat warning]

- [AL. 046.2 Servo motor overheat] may occur.

[AL. 0E2.1_Servo motor temperature warning]

Cause	Check/action method	Model
1. The temperature of the servo motor reached 85 % of the occurrence level of [AL. 046.2 Servo motor overheat].	 Page 79 [AL. 046.2_Servo motor temperature error 2]	[G] [B] [A]

[AL. 0E2.2_Servo motor temperature warning 2]

Cause	Check/action method	Model
1. The temperature inside of the servo motor has reached a warning level.	 Page 79 [AL. 046.1_Servo motor temperature error 1]	[G] [B] [A]

[AL. 0E3_Absolute position counter warning]

- The multi-revolution counter of the absolute position encoder exceeded the maximum range.
- There is an error in the absolute position encoder pulses.

[AL. 0E3.1_Multi-revolution counter travel distance exceeded warning]

Cause	Check/action method	Model
1. In the absolute position system, the travel distance from the home position became 32768 rev or more.	Review the operation range. After the power is cycled, perform homing again.	[G] [A]
2. When an absolute position detection system is configured in the cyclic synchronous mode with a Motion module manufactured by Mitsubishi Electric, [Pr. PC29.5 [AL. 0E3 Absolute position counter warning] selection] is not set to "0" (disabled).	Set [Pr. PC29.5] to "0" (disabled).	[G]

[AL. 0E3.2_Absolute position counter warning]

Cause	Check/action method	Model
1. There is a problem with the surrounding environment.	Check the noise, ambient temperature, and other conditions, and implement appropriate countermeasures for the cause. If there is noise, take countermeasures to reduce the noise. Refer to "Noise reduction techniques" in the following manuals. <ul style="list-style-type: none"> 📖 MR-J5 User's Manual (Hardware) 📖 MR-J5D User's Manual (Hardware) After the power is cycled, perform homing again.	[G] [B] [A]
2. The encoder has malfunctioned.	Replace the servo motor.	

[AL. 0E3.5_Encoder absolute position counter warning]

📖 Page 128 [AL. 0E3.2_Absolute position counter warning]

[AL. 0E3.6_Scale measurement encoder absolute position counter warning]

Cause	Check/action method	Model
1. There is a problem with the surrounding environment.	Check the noise, ambient temperature, and other conditions, and implement appropriate countermeasures for the cause. If there is noise, take countermeasures to reduce the noise. Refer to "Noise reduction techniques" in the following manuals. <ul style="list-style-type: none"> 📖 MR-J5 User's Manual (Hardware) 📖 MR-J5D User's Manual (Hardware) 	[G] [B]
2. The encoder has malfunctioned.	Replace the servo motor or the encoder.	

[AL. 0E4_Parameter warning]

- A parameter value outside of the setting range was attempted to be written.

[AL. 0E4.1_Parameter setting range error warning]

Cause	Check/action method	Model
1. A parameter was set outside of the setting range with the controller.	Set the value within the setting range.	[B]

[AL. 0E5_ABS time-out warning]

- When transferring the absolute position data, it took more than 5 s for the programmable controllers to respond.
- During absolute position erased data transfer, ABSM (ABS transfer mode) turned off.
- SON (Servo-on), RES (Reset), EM2 (Forced stop 2), or EM1 (Forced stop 1) turned off during absolute position erased data transfer.

[AL. 0E5.1_Time-out during ABS data transfer]

Cause	Check/action method	Model
1. The wiring of input/output signals is incorrect.	Check for disconnection or loose connection in the I/O signal wire.	[A]
2. The sequence program is incorrect.	Modify the sequence program.	

[AL. 0E5.2_ABSM off during ABS data transfer]

☞ Page 130 [AL. 0E5.1_Time-out during ABS data transfer]

[AL. 0E5.3_SON off during ABS data transfer]

☞ Page 130 [AL. 0E5.1_Time-out during ABS data transfer]

[AL. 0E6_Servo forced stop warning]

- EM2 (Forced stop 2) or EM1 (Forced stop 1) was turned off.

[AL. 0E6.1_Forced stop warning]

Cause	Check/action method	Model
1. EM2/EM1 was turned off.	After ensuring safety, turn EM2/EM1 on.	[G]
2. An external 24 V DC power supply has not been input.	Input the external 24 V DC power supply.	[B] [A]
3. The servo amplifier has malfunctioned.	Replace the servo amplifier.	

[AL. 0E7_Controller forced stop warning]

- The emergency stop of the controller became enabled.

[AL. 0E7.1_Controller forced stop input warning]

Cause	Check/action method	Model
1. The emergency stop signal of the controller was input.	Ensure safety, then cancel the emergency stop signal of the controller.	[B]

[AL. 0E8_Decreased cooling fan speed warning]

- The cooling fan speed decreased to a warning level or lower.

[AL. 0E8.1_Decreased cooling fan speed]

Cause	Check/action method	Model
1. A foreign object was caught in the cooling fan.	Remove the foreign object.	[G]
2. The cooling fan has reached the end of its service life.	Check the total of the power-on time of the servo amplifier. If the service life of the cooling fan is exceeded, replace the servo amplifier or the fan unit.	[B] [A]

[AL. 0E8.2_Cooling fan stop]

Page 133 [AL. 0E8.1_Decreased cooling fan speed]

[AL. 0E9_Main circuit off warning]

- The servo-on command was input with the main circuit power supply off.
- The bus voltage dropped when the servo motor was rotating at 50 r/min or lower.

[AL. 0E9.1_Servo-on signal on during main circuit off]

Cause	Check/action method	Model
1. The bus voltage is less than the specified value. 200 V class: 215 V DC 400 V class: 430 V DC	Review the wiring. Check the power supply capacity.	[G] [B] [A]
2. The servo-on command was input with the main circuit power supply off.	Turn on the main circuit power.	
3. The wiring between P3 and P4 is disconnected. This does not apply to multi-axis servo amplifiers.	Wire between P3 and P4.	
4. The main circuit power supply wiring is disconnected.	Wire the main circuit power supply.	
5. The fuse was disconnected.	Check the charge light after a certain period of time.	
6. The power supply capacity is insufficient.	Check if the specified power supply capacity is satisfied.	
7. Main circuit capacitor has deteriorated.	After checking the operation time and ambient temperature, replace the servo amplifier if the main circuit capacitor has reached the end of its service life. Refer to "Parts with a service life" in the User's Manual (Introduction).	
8. The servo amplifier has malfunctioned.	Replace the servo amplifier.	
9. For the MR-J5D_, the servo-on command was input with the power supply off.	Turn on the power supply of the converter unit.	[G]
10. For the MR-J5D_, the wiring of the main circuit power supply of the converter unit is disconnected.	Check the wiring of the main circuit power supply of the converter unit. Refer to "Example power circuit connections" in the following manual. <input type="checkbox"/> MR-J5D User's Manual (Hardware)	
11. For the MR-J5D_, the magnetic contactor control connector of the converter unit is disconnected.	Check the magnetic contactor control connector of the converter unit. Refer to "Magnetic contactor control connector (CN23)" in the following manual. <input type="checkbox"/> MR-CV Power Regeneration Converter Unit User's Manual	
12. For the MR-J5D_, the bus bar that connects the converter unit and the MR-J5D_ is disconnected.	Check if the bus bar has been installed correctly. Refer to "How to use the bus bar" in the following manual. <input type="checkbox"/> MR-J5D User's Manual (Hardware)	
13. The converter unit has malfunctioned.	Replace the converter unit, then check the repeatability. If the error does not repeat, replace the converter unit.	

[AL. 0E9.2_Bus voltage drop during low speed operation]

Cause	Check/action method	Model
1. The bus voltage dropped under the specified value when the servo motor was rotating at 50 r/min or lower. 200 V class: 200 V DC 400 V class: 380 V DC	Review the power supply capacity. Increase the acceleration time constant.	[G] [B] [A]

[AL. 0E9.3_Ready-on signal on during main circuit off]

 Page 134 [AL. 0E9.1_Servo-on signal on during main circuit off]

[AL. 0E9.4_Converter unit forced stop]

Cause	Check/action method	Model
1. Forced stop of the converter unit became enabled during input of the servo-on command from the controller.	Cancel forced stop of the converter unit.	[G]
2. The protection coordination cable is not connected correctly.	Connect the protection coordination cable correctly. Refer to "Example power circuit connections" in the following manual.  MR-J5D User's Manual (Hardware)	

[AL. 0EA_ABS servo-on warning]

- The servo amplifier did not become servo-on status within 1 s after ABSM (ABS transfer mode) was turned on.

[AL. 0EA.1_ABS servo-on warning]

Cause	Check/action method	Model
1. The wiring of input/output signals is incorrect.	Check for disconnection or loose connection in the I/O signal wire.	[A]
2. The sequence program is incorrect.	Modify the sequence program so that servo-on is enabled within 1 s after ABSM (ABS transfer mode) is turned on.	

[AL. 0EB_The other axis error warning]

- An alarm, which stops all axes, such as [AL. 024 Main circuit error] or [AL. 032 Overcurrent] occurred on a different axis.
- [Pr. PF02.0 Target alarm selection of the other axis error warning] is set to "1" (All alarms).

[AL. 0EB.1_The other axis error warning]

Cause	Check/action method	Model
1. [AL. 024 Main circuit error] occurred on a different axis.	Eliminate the cause of [AL. 024] on the axis.	[G] [B]
2. [AL. 032 Overcurrent] occurred on a different axis.	Eliminate the cause of [AL. 032] on the axis.	
3. [Pr. PF02.0 Target alarm selection of the other axis error warning] is set to "1" (All alarms).	Remove the cause of the alarm on a different axis.	

[AL. 0EC_Overload warning 2]

- Operation was repeated with a high load ratio while the servo motor shaft was not rotating.

[AL. 0EC.1_Overload warning 2]

Cause	Check/action method	Model
1. The load is excessive or the capacity is insufficient.	Reduce the load or replace the servo motor with a larger-capacity servo motor.	[G] [B] [A]

[AL. 0ED_Output watt excess warning]

- The output wattage (speed × torque) of the servo motor exceeded the rated output, and that status continued steadily.

[AL. 0ED.1_Output watt excess warning]

Cause	Check/action method	Model
1. The output wattage of the servo motor (speed × torque or thrust) steadily exceeds 120 % of the rated output (continuous thrust).	Reduce the servo motor speed, reduce the load, or replace the servo motor with a larger-capacity servo motor.	[G] [B] [A]

[AL. 0EF_Reverse-side stop warning]

- The set reverse-side position was exceeded in the pressure control mode.

[AL. 0EF.1_Reverse-side stop warning]

Cause	Check/action method	Model
1. The setting of [Pr. PW12.2 Forward/reverse-side stop function] is incorrect.	Check if the setting value of [Pr. PW12.2 Forward/reverse-side stop function] is "1".	[G] [B]

[AL. 0F0_Tough drive warning]

- The tough drive function was activated.

[AL. 0F0.1_Instantaneous power failure tough drive warning]

Cause	Check/action method	Model
1. The voltage of the control circuit power supply has dropped.	☞ Page 32 [AL. 010.1_Voltage drop in the control circuit power]	[G] [B] [A]

[AL. 0F0.3_Vibration tough drive warning]

Cause	Check/action method	Model
1. The setting value of the machine resonance suppression filter was changed due to a machine resonance.	Set the machine resonance suppression filter. Check the machine status for loose screws and other problems.	[G] [B] [A]

[AL. 0F2_Drive recorder warning]

- Writing/reading/clearing of the drive recorder data failed.

[AL. 0F2.1_Drive recorder warning 1]

Cause	Check/action method	Model
1. There is an error in the drive recorder data.	Check if clearing the alarm history of the drive recorder with MR Configurator2 disables the warning.	[G] [B] [A]
2. There is a memory error.	<ul style="list-style-type: none">☞ Page 150 [AL. 119.1_Memory error 4-1]☞ Page 150 [AL. 119.7_Memory free space error 4-1]☞ Page 151 [AL. 119.8_Memory free space error 4-2]	
3. The Flash-ROM has malfunctioned.	Replace the servo amplifier.	

[AL. 0F2.2_Drive recorder warning 2]

☞ Page 142 [AL. 0F2.1_Drive recorder warning 1]

[AL. 0F2.3_Drive recorder warning 3]

☞ Page 142 [AL. 0F2.1_Drive recorder warning 1]

[AL. 0F2.4_Drive recorder warning 4]

☞ Page 142 [AL. 0F2.1_Drive recorder warning 1]

[AL. 0F2.5_Drive recorder warning 5]

☞ Page 142 [AL. 0F2.1_Drive recorder warning 1]

[AL. 0F2.6_Drive recorder warning 6]

☞ Page 142 [AL. 0F2.1_Drive recorder warning 1]

[AL. 0F3_Oscillation detection warning]

- The oscillation of the servo motor was detected.

[AL. 0F3.1_Oscillation detection warning]

☞ Page 87 [AL. 054.1_Oscillation detection error]

[AL. 0F4_Positioning warning]

- The target position or the acceleration/deceleration time constant was set outside of the setting range.

[AL. 0F4.4_Target position setting range error warning]

Cause	Check/action method	Model
1. The target position was set outside of the setting range.	Set the target position correctly, then cancel the warning (turn on C_ORST).	[G]

[AL. 0F4.6_Acceleration time constant setting range error warning]

Cause	Check/action method	Model
1. The acceleration time constant was set outside of the setting range.	Set [Pr. PT49 Speed acceleration time constant] correctly, then cancel the warning by turning on C_ORST (Operation alarm reset).	[G]

[AL. 0F4.7_Deceleration time constant setting range error warning]

Cause	Check/action method	Model
1. The deceleration time constant was set outside of the setting range.	Set [Pr. PT50 Speed deceleration time constant] correctly, then cancel the warning by turning on C_ORST (Operation alarm reset).	[G]

[AL. 0F4.8_Control command input error warning]

Cause	Check/action method	Model
1. The relative position command was input while the unit was set to "degree".	If Controlword bit 6 is on while [Pr. PT01.2 Unit for position data] is set to "2", turn off Controlword bit 6, then cancel the warning (turn on C_ORST).	[G]

[AL. 0F4.A_Fully closed loop control - Switching warning]

Cause	Check/action method	Model
1. Switching between the semi closed loop control and fully closed loop control was executed during the homing mode (hm) or profile position mode (pp).	Stop the operation in the homing mode (hm) or profile position mode (pp). Cancel the warning by turning on C_ORST.	[G]

[AL. 0F7_Machine diagnosis warning]

- The equipment on which the servo motor is installed may have malfunctioned.

[AL. 0F7.1_Vibration failure prediction warning]

Cause	Check/action method	Model
1. Due to degradation of components in the equipment, the vibration at servo motor driving became larger.	When the increase in the vibration level during motor operation is less than 5 % of the rated torque from the initial operation, set a larger value for vibration failure prediction threshold multiplication, then restart the equipment. [G] [B]: [Pr. PF40.1 Vibration failure prediction - Threshold multiplication] [A]: [Pr. PF52.1 Vibration failure prediction - Threshold multiplication] When the increase in the vibration level during motor operation is equal to or more than 5 % of the rated torque from the initial operation, perform an inspection and maintenance of the equipment as necessary.	[G] [B] [A]
2. The servo system is unstable and oscillating.	Check if the gain has been changed after the vibration failure prediction function is activated. Adjust the servo gain with the auto tuning. Set the machine resonance suppression filter.	

[AL. 0F7.2_Friction failure prediction warning]

Cause	Check/action method	Model
1. Due to degradation of components in the equipment, the friction of the equipment changed.	If the friction torques are the same at the initial operation and at the rated speed, set a larger value for vibration failure prediction threshold multiplication, then restart the equipment. [G] [B]: [Pr. PF40.0 Friction failure prediction - Threshold multiplication] [A]: [Pr. PF52.0 Friction failure prediction - Threshold multiplication] If the friction torque at the rated speed changed from the initial operation, perform an inspection and maintenance of the equipment as necessary.	[G] [B] [A]
2. As the surrounding environment changed, the friction of the equipment was also changed.	If the operating environment, such as the ambient temperature, was changed from the initial operation, reset the threshold, then re-create the threshold.	

[AL. 0F7.3_Failure prediction warning based on servo motor total travel distance]

Cause	Check/action method	Model
1. The servo motor total travel distance has exceeded the threshold.	Check if the threshold has been set correctly. If the threshold value is incorrect, set each servo parameter so that the setting value of the servo motor total travel distance will be an approximation of the rated life, then restart the device. [G] [B]: [Pr. PF41 Failure prediction - Servo motor total travel distance] [A]: [Pr. PF53 Failure prediction - Servo motor total travel distance] If the threshold setting is correct, perform an inspection and maintenance of the equipment. Refer to "Total travel distance failure prediction function" in the following manual.  MR-J5 User's Manual (Function)	[G] [B] [A]

[AL. 0F7.4_Gear failure prediction warning]

Cause	Check/action method	Model
1. Gear abrasion made the backlash larger.	Compare the backlash estimation value with the backlash presented by the gear manufacturer. If the backlash estimation value is larger than the backlash presented by the gear manufacturer, perform an inspection and maintenance of the equipment.	[G] [B] [A]
2. The value for the backlash estimation was set incorrectly.	Set [Pr. PF66.0-3 Gear for backlash estimation - Numerator] and [Pr. PF66.4-7 Gear for backlash estimation - Denominator] to the same value as the gear ratio of the gear connected to the servo motor. Check that [Pr. PF67 Backlash nominal value] is equivalent to the value shown by the manufacturer of the gears connected to the servo motor. When setting "0" for [Pr. PF66.0-3] or [Pr. PF66.4-7], set [Pr. PF67] by converting the value into the rotation angle on the servo motor side. When setting other than "0" for [Pr. PF66.0-3] and [Pr. PF66.4-7], set [Pr. PF67] by converting the value into the rotational load on the load side. Set [Pr. PF68 Backlash threshold multiplication] to a value more than two times larger.	

[AL. 0F7.5_Static friction failure prediction warning]

Cause	Check/action method	Model
1. As the surrounding environment changed, the friction of the equipment was also changed.	If the operating environment was changed from the initial operation, reset the threshold, then re-create a threshold. If the operating environment is unchanged, refer to 2 and examine the equipment.	[G] [B] [A]
2. Changes in the equipment configuration changed the friction of the equipment.	If the equipment configuration is changed, reset the threshold, then create a threshold again. If the equipment configuration is unchanged, refer to 3 and examine the equipment.	
3. Due to degradation of components in the equipment, the friction of the equipment changed.	Check if the static friction has been changed from the initial operation. If the static friction has not been changed, set a larger value for static friction failure prediction threshold multiplication, then restart the equipment. [G] [B]: [Pr. PF40.4 Static friction failure prediction - Threshold multiplication] [A]: [Pr. PF52.4 Static friction failure prediction - Threshold multiplication] If the static friction has been changed, perform an inspection and maintenance of the equipment as necessary.	

[AL. 0F7.6_Belt failure prediction warning]

Cause	Check/action method	Model
1. Belt extension made the belt tension smaller.	If the value of the belt tension estimation is too small, perform an inspection and maintenance of the equipment.	[G] [B] [A]
2. The setting of the belt tension threshold is incorrect.	Set the belt tension threshold to [Pr. PF76 Belt tension irregular threshold] with taking the initial belt stretch into account.	

[AL. 0FE_Two-digit warning No. display warning]

- A three-digit warning is occurring.

[AL. 0FE.1_Two-digit warning No. display warning for AL. 100 to AL. 1FF]

Cause	Check/action method	Model
1. A warning with warning No. in 100s ([AL. 1_ _]) is occurring.	Check the warning number using an object that can read three-digit numbers, the servo amplifier display, or MR Configurator2, and take corrective action.	[G]

[AL. 0FE.2_Two-digit warning No. display warning for AL. 200 to AL. 2FF]

Cause	Check/action method	Model
1. A warning with warning No. in 200s ([AL. 2_ _]) is occurring.	Check the warning number using an object that can read three-digit numbers, the servo amplifier display, or MR Configurator2, and take corrective action.	[G]

[AL. 0FE.3_Two-digit warning No. display warning for AL. 300 to AL. 3FF]

Cause	Check/action method	Model
1. A warning with warning No. in 300s ([AL. 3_ _]) is occurring.	Check the warning number using an object that can read three-digit numbers, the servo amplifier display, or MR Configurator2, and take corrective action.	[G]

[AL. 0FE.4_Two-digit warning No. display warning for AL. 400 to AL. 4FF]

Cause	Check/action method	Model
1. A warning with warning No. in 400s ([AL. 4_ _]) is occurring.	Check the warning number using an object that can read three-digit numbers, the servo amplifier display, or MR Configurator2, and take corrective action.	[G]

[AL. 0FE.5_Two-digit warning No. display warning for AL. 500 to AL. 5FF]

Cause	Check/action method	Model
1. A warning with warning No. in 500s ([AL. 5_ _]) is occurring.	Check the warning number using an object that can read three-digit numbers, the servo amplifier display, or MR Configurator2, and take corrective action.	[G]

[AL. 0FE.6_Two-digit warning No. display warning for AL. 600 to AL. 6FF]

Cause	Check/action method	Model
1. A warning with warning No. in 600s ([AL. 6_ _]) is occurring.	Check the warning number using an object that can read three-digit numbers, the servo amplifier display, or MR Configurator2, and take corrective action.	[G]

[AL. 0FE.7_Two-digit warning No. display warning for AL. 700 to AL. 7FF]

Cause	Check/action method	Model
1. A warning with warning No. in 700s ([AL. 7_ _]) is occurring.	Check the warning number using an object that can read three-digit numbers, the servo amplifier display, or MR Configurator2, and take corrective action.	[G]

[AL. 0FE.8_Two-digit warning No. display warning for AL. 800 to AL. 8FF]

Cause	Check/action method	Model
1. A warning with warning No. in 800s ([AL. 8_ _]) is occurring.	Check the warning number using an object that can read three-digit numbers, the servo amplifier display, or MR Configurator2, and take corrective action.	[G]

[AL. 0FE.9_Two-digit warning No. display warning for AL. 900 to AL. 9FF]

Cause	Check/action method	Model
1. A warning with warning No. in 900s ([AL. 9_ _]) is occurring.	Check the warning number using an object that can read three-digit numbers, the servo amplifier display, or MR Configurator2, and take corrective action.	[G]

[AL. 0FE.A_Two-digit warning No. display warning for AL. A00 to AL. AFF]

Cause	Check/action method	Model
1. A warning with warning No. in A00s ([AL. A_ _]) is occurring.	Check the warning number using an object that can read three-digit numbers, the servo amplifier display, or MR Configurator2, and take corrective action.	[G]

[AL. 0FE.B_Two-digit warning No. display warning for AL. B00 to AL. BFF]

Cause	Check/action method	Model
1. A warning with warning No. in B00s ([AL. B_ _]) is occurring.	Check the warning number using an object that can read three-digit numbers, the servo amplifier display, or MR Configurator2, and take corrective action.	[G]

[AL. 0FE.C_Two-digit warning No. display warning for AL. C00 to AL. CFF]

Cause	Check/action method	Model
1. A warning with warning No. in C00s ([AL. C_ _]) is occurring.	Check the warning number using an object that can read three-digit numbers, the servo amplifier display, or MR Configurator2, and take corrective action.	[G]

[AL. 0FE.D_Two-digit warning No. display warning for AL. D00 to AL. DFF]

Cause	Check/action method	Model
1. A warning with warning No. in D00s ([AL. D_ _]) is occurring.	Check the warning number using an object that can read three-digit numbers, the servo amplifier display, or MR Configurator2, and take corrective action.	[G]

[AL. 0FE.E_Two-digit warning No. display warning for AL. E00 to AL. EFF]

Cause	Check/action method	Model
1. A warning with warning No. in E00s ([AL. E_ _]) is occurring.	Check the warning number using an object that can read three-digit numbers, the servo amplifier display, or MR Configurator2, and take corrective action.	[G]

[AL. 0FE.F_Two-digit warning No. display warning for AL. F00 to AL. FFF]

Cause	Check/action method	Model
1. A warning with warning No. in F00s ([AL. F_ _]) is occurring.	Check the warning number using an object that can read three-digit numbers, the servo amplifier display, or MR Configurator2, and take corrective action.	[G]

[AL. 118_ Encoder diagnosis]

- The servo amplifier is in the test operation mode.

[AL. 118.1_ Encoder communication circuit diagnosis in progress]

Cause	Check/action method	Model
1. The servo amplifier is in the encoder communication circuit diagnosis mode.	Cancel the encoder communication circuit diagnosis mode. Refer to "Encoder communication diagnosis function" in the following manual.  MR-J5 User's Manual (Function)	[G] [B] [A]

[AL. 119_Memory error 4]

- There is a memory error.

[AL. 119.1_Memory error 4-1]

Cause	Check/action method	Model
1. There is a problem with the surrounding environment.	Check the power supply for noise. If there is noise, take countermeasures to reduce the noise. Check if the connector has shorted. Refer to "Noise reduction techniques" in the following manuals. ☐MR-J5 User's Manual (Hardware) ☐MR-J5D User's Manual (Hardware)	[G] [B] [A]
2. An internal part of the servo amplifier has malfunctioned.	Replace the servo amplifier.	

[AL. 119.2_Memory error 4-2]

☞ Page 150 [AL. 119.1_Memory error 4-1]

[AL. 119.3_Memory error 4-3]

Cause	Check/action method	Model
1. The firmware has been updated.	Update it to the latest firmware version, then check the repeatability. If the failure continues, the servo amplifier may have malfunctioned. Replace the servo amplifier.	[G]
2. Take actions in accordance with the items shown below. ☞ Page 150 [AL. 119.1_Memory error 4-1]		[G] [B] [A]

[AL. 119.4_Memory error 4-4]

☞ Page 150 [AL. 119.1_Memory error 4-1]

[AL. 119.5_Memory error 4-5]

Cause	Check/action method	Model
1. The firmware has been updated.	Cycle the power, then check the repeatability. If the failure continues, the servo amplifier may have malfunctioned. Replace the servo amplifier.	[G] [A]
2. Take actions in accordance with the items shown below. ☞ Page 150 [AL. 119.1_Memory error 4-1]		[G] [B] [A]

[AL. 119.6_Memory error 4-6]

☞ Page 150 [AL. 119.1_Memory error 4-1]

[AL. 119.7_Memory free space error 4-1]

Cause	Check/action method	Model
1. The free memory space is insufficient.	Delete unnecessary files to free up the memory. If no files can be deleted, make a backup of necessary data such as parameters, then initialize the servo amplifier and check the repeatability. If the failure continues, replace the servo amplifier. Refer to "Servo amplifier setting initialization" or "Drive unit setting initialization" in the User's Manual (Introduction).	[G] [B] [A]

[AL. 119.8_Memory free space error 4-2]

Cause	Check/action method	Model
1. Too many files are saved in the memory.	Delete files to reduce the number of files. If deleting files does not solve the problem, make a backup of necessary data such as parameters, then initialize the servo amplifier and check the repeatability. If the failure continues, replace the servo amplifier. Refer to "Servo amplifier setting initialization" or "Drive unit setting initialization" in the User's Manual (Introduction).	[G] [B] [A]

[AL. 11A_Servo motor constant error]

- The servo motor constant file is damaged.

[AL. 11A.1_Servo motor constant file error]

Cause	Check/action method	Model
1. Writing of the servo motor constant file failed.	There is a possibility that the servo motor constant file is damaged primarily due to noise entering the file while the file was written. After writing the servo motor constant again, cycle the power. For details of actions to be taken, contact your local sales office.	[G] [B] [A]
2. There is a problem with the surrounding environment.	Check the noise, ambient temperature, and other conditions, and implement appropriate countermeasures for the cause. If there is noise, take countermeasures to reduce the noise. Refer to "Noise reduction techniques" in the following manuals. MR-J5 User's Manual (Hardware) MR-J5D User's Manual (Hardware)	
3. The Flash-ROM has malfunctioned.	Replace the servo amplifier.	

[AL. 11A.2_Servo motor constant file extension error]

Cause	Check/action method	Model
1. A file with an extension other than ".mmd2" was written as the servo motor constant file.	Delete the written file, then write another file with the extension ".mmd2". For details of actions to be taken, contact your local sales office.	[G] [B] [A]
2. There is a problem with the surrounding environment.	Check the noise, ambient temperature, and other conditions, and implement appropriate countermeasures for the cause. If there is noise, take countermeasures to reduce the noise. Refer to "Noise reduction techniques" in the following manuals. MR-J5 User's Manual (Hardware) MR-J5D User's Manual (Hardware)	

[AL. 11A.3_Servo motor constant file amount error]

Cause	Check/action method	Model
1. Two or more servo motor constant files were written in the servo motor constant folder.	Delete the written files, then write only one servo motor constant file. For details of actions to be taken, contact your local sales office.	[G] [B] [A]
2. There is a problem with the surrounding environment.	Check the noise, ambient temperature, and other conditions, and implement appropriate countermeasures for the cause. If there is noise, take countermeasures to reduce the noise. Refer to "Noise reduction techniques" in the following manuals. MR-J5 User's Manual (Hardware) MR-J5D User's Manual (Hardware)	
3. The Flash-ROM has malfunctioned.	Replace the servo amplifier.	

[AL. 11B_Protection coordination connection error]

- There is a problem with the protection coordination cable connection and setting.
- The protection coordination cable was disconnected.



[AL. 11B.1_Protection coordination end terminal setting error]

Cause	Check/action method	Model
1. The setting of the protection coordination end terminal is incorrect.	Check the system configuration and the setting value of [Pr. PC46.3 Protection coordination end terminal setting].	[G]
2. The protection coordination cable is not connected correctly.	Connect the protection coordination cable correctly. Refer to "Example power circuit connections" in the following manual.  MR-J5D User's Manual (Hardware)	
3. The protection coordination cable was disconnected.	Replace the protection coordination cable, then check the repeatability.	

[AL. 130_Regenerative error 2]

- The regenerative power exceeds the permissible regenerative power of the built-in regenerative resistor or regenerative option.
- The regenerative transistor in the servo amplifier has malfunctioned.

[AL. 130.1_Regenerative heat error]

Cause	Check/action method	Model
1. The settings of the regenerative resistor (regenerative option) are incorrect.	Refer to "Regenerative option" in the following manual.  MR-J5 User's Manual (Hardware)	[G] [B] [A]
2. The regenerative resistor (regenerative option) is not connected.	Refer to "Regenerative option" in the following manual.  MR-J5 User's Manual (Hardware)	
3. The regenerative resistor (regenerative option) and the servo amplifier are connected in a wrong combination.	Check the combination of the regenerative resistor (regenerative option) and the servo amplifier. Refer to "Regenerative option" in the following manual.  MR-J5 User's Manual (Hardware)	
4. The power supply voltage is too high.	Check if the voltage of the input power supply exceeds the upper limit of the permissible voltage. If it exceeds the limit, lower the power supply voltage. 200 V class: 264 V AC 400 V class: 528 V AC	
5. The regenerative power is too large.	Check whether the regenerative load ratio exceeds the upper limit value when the alarm occurs. Take the corrective actions as follows. <ul style="list-style-type: none"> • Reduce the frequency of positioning. • Set a longer deceleration time constant. • Reduce the load. • Use a regenerative option if it is not being used. • For a multi-axis servo amplifier, ensure that each axis does not decelerate simultaneously. 	

[AL. 139_Open-phase error]

- An open phase occurred in the main circuit power supply of the servo amplifier.
- An open phase occurred in the servo motor power line.

[AL. 139.1_Input open-phase error]

Cause	Check/action method	Model
1. An open phase occurred in the main circuit power line of the servo amplifier.	Check that the main circuit power line is connected with the servo amplifier. Make sure that 1-phase AC power supply is not input to the servo amplifier that cannot use 1-phase AC power supply. Check if the main circuit power line of the servo amplifier is closed. If the main circuit power line of the servo amplifier is open, replace the main circuit power line.	[G] [B] [A]
2. The main circuit power supply is distorted.	Review the power-supply environment of the main circuit.	
3. For the MR-J5D_, input open-phase detection is enabled.	Set [Pr. PC20.4 Input open-phase detection selection] to "0" and cycle the power.	[G]

[AL. 139.2_Output open-phase error]

Cause	Check/action method	Model
1. An open phase occurred in the servo motor power line.	Check that the servo motor power line is connected with the servo amplifier. Check that the servo motor power supply is connected with the servo amplifier. Check if the servo motor power line is closed. If the servo motor power line is open, replace the servo motor power line.	[G] [B] [A]
2. The winding inside the servo motor is disconnected.	Replace the servo motor, then check the repeatability.	

[AL. 139.3_Servo motor wiring error]

Cause	Check/action method	Model
1. The servo motor that has been connected with the servo motor power line is not the servo motor to be connected. The servo motor that has been connected with the encoder cable is not the servo motor to be connected.	Check the servo motor to which the servo motor power line and encoder cable are connected. Check if the servo motor power line is closed. If the servo motor power line is open, replace the servo motor power line.	[G] [B]
2. The winding inside the servo motor is disconnected.	Replace the servo motor, then check the repeatability.	

[AL. 139.4_Limit detection error at servo motor incorrect wiring detection]

Cause	Check/action method	Model
1. The limit switches are turned off when the motor incorrect wiring is detected.	Check the limit switches and remove the cause.	[G]

[AL. 13D_Driver communication network setting error]

- There is a problem with the network settings of driver communication.

[AL. 13D.1_Driver communication - Cyclic transmission setting unset error]

Cause	Check/action method	Model
1. The connected controller does not support driver communication.	Connect a controller that supports driver communication.	[G]
2. The network settings of driver communication have not been configured correctly.	Set [Pr. PD22 Driver communication setting - Slave - Master axis 1 - Station No. setting] and [Pr. PD23.1 Driver communication setting - Slave - Master axis 1 - Control slave axis No. setting] of the slave axis correctly. Refer to "Network settings" in the User's Manual (Communication Function).	
3. The parameter automatic setting has been disabled.	Enable the parameter automatic setting on the controller side.	

[AL. 13D.2_Driver communication - Cyclic transmission setting error]

Cause	Check/action method	Model
1. The network settings of driver communication have not been configured correctly.	Set [Pr. PD22 Driver communication setting - Slave - Master axis 1 - Station No. setting] and [Pr. PD23.1 Driver communication setting - Slave - Master axis 1 - Control slave axis No. setting] of the slave axis correctly. Refer to "Network settings" in the User's Manual (Communication Function).	[G]

[AL. 13D.3_Driver communication - Control slave axis setting unset error]

Cause	Check/action method	Model
1. The servo amplifier has not been set as a control slave axis.	Set [Pr. PD23.1 Driver communication setting - Slave - Master axis 1 - Control slave axis No. setting] of the slave axis correctly.	[G]

[AL. 168_STO function error]

- There is a problem with the STO function.

[AL. 168.1_STO function error]

Cause	Check/action method	Model
1. A servo amplifier that is not compatible with the STO function does not have a short-circuit connector connected to its CN8 connector.	Install the short-circuit connector attached to the servo amplifier in the CN8.	[G] [A]

[AL. 16A_Master-slave operation simultaneous stop error]

- An error in the master-slave operation simultaneous stop function was detected.

[AL. 16A.1_Master-slave operation simultaneous stop error 1]

☞ Page 104 [AL. 086.1_Network communication error 1]

[AL. 16A.2_Master-slave operation simultaneous stop error 2]

☞ Page 104 [AL. 086.1_Network communication error 1]

[AL. 17A_Load-side linear encoder error 1]

- A problem with the linear encoder was detected in the fully closed loop control mode. The content of the errors varies depending on each encoder manufacturer.
- A problem with the linear encoder (scale measurement encoder) was detected in the scale measurement mode. The content of the errors varies depending on each encoder manufacturer.

[AL. 17A.1_Load-side linear encoder error 1-1]

Cause	Check/action method	Model
1. The linear encoder and the head have been incorrectly mounted.	Adjust the positions of the linear encoder and the head.	[G] [B] [A]
2. The external conductor of the encoder cable is not connected to the ground plate of the connector.	Refer to "Shield procedure of CN2, CN2A, CN2B, and CN2C side connectors" in the following manual. ☞MR-J5 Partner's Encoder User's Manual	
3. There is a problem with the surrounding environment.	Check the noise, ambient temperature, and other conditions, and implement appropriate countermeasures for the cause. If there is noise, take countermeasures to reduce the noise. Refer to "Noise reduction techniques" in the following manuals. ☞MR-J5 User's Manual (Hardware) ☞MR-J5D User's Manual (Hardware)	
4. A linear encoder alarm was detected.	Refer to "DETAILED EXPLANATION OF [AL. 02A LINEAR ENCODER ERROR 1]" in the following manual. ☞MR-J5 Partner's Encoder User's Manual	

[AL. 17A.2_Load-side linear encoder error 1-2]

☞ Page 159 [AL. 17A.1_Load-side linear encoder error 1-1]

[AL. 17A.3_Load-side linear encoder error 1-3]

☞ Page 159 [AL. 17A.1_Load-side linear encoder error 1-1]

[AL. 17A.4_Load-side linear encoder error 1-4]

☞ Page 159 [AL. 17A.1_Load-side linear encoder error 1-1]

[AL. 17A.5_Load-side linear encoder error 1-5]

☞ Page 159 [AL. 17A.1_Load-side linear encoder error 1-1]

[AL. 17A.6_Load-side linear encoder error 1-6]

☞ Page 159 [AL. 17A.1_Load-side linear encoder error 1-1]

[AL. 17A.7_Load-side linear encoder error 1-7]

☞ Page 159 [AL. 17A.1_Load-side linear encoder error 1-1]

[AL. 17A.8_Load-side linear encoder error 1-8]

☞ Page 159 [AL. 17A.1_Load-side linear encoder error 1-1]

[AL. 182_Driver communication error]

- A driver communication error was detected.

[AL. 182.1_Driver communication error 1]

☞ Page 104 [AL. 086.1_Network communication error 1]

[AL. 182.2_Driver communication error 2]

☞ Page 104 [AL. 086.1_Network communication error 1]

[AL. 186_Network communication error 2]

- An error occurred in the network communication.

[AL. 186.1_Network communication error 2-1]

Cause	Check/action method	Model
1. There is a problem with the surrounding environment.	Check the noise, ambient temperature, and other conditions, and implement appropriate countermeasures for the cause. If there is noise, take countermeasures to reduce the noise. Refer to "Noise reduction techniques" in the following manuals. <ul style="list-style-type: none"> ☐ MR-J5 User's Manual (Hardware) ☐ MR-J5D User's Manual (Hardware) 	[G]
2. The servo amplifier has malfunctioned.	Replace the servo amplifier.	

[AL. 186.2_Network communication error 2-2]

☞ Page 161 [AL. 186.1_Network communication error 2-1]

[AL. 186.3_Network communication error 2-3]

☞ Page 161 [AL. 186.1_Network communication error 2-1]

[AL. 186.4_Network communication error 2-4]

☞ Page 161 [AL. 186.1_Network communication error 2-1]

[AL. 186.5_Network communication error 2-5]

☞ Page 161 [AL. 186.1_Network communication error 2-1]

[AL. 186.6_Network communication error 2-6]

☞ Page 161 [AL. 186.1_Network communication error 2-1]

[AL. 188_Watchdog 2]

- The CPU or other component parts have malfunctioned.

[AL. 188.1_Watchdog 2-1]

Cause	Check/action method	Model
1. An internal part of the servo amplifier has malfunctioned.	Replace the servo amplifier.	[G] [B] [A]

[AL. 19D_IP address setting change warning]

- The IP address setting with engineering software was incorrect.

[AL. 19D.1_IP address change unreflected warning]

Cause	Check/action method	Model
1. The IP address setting with engineering software was configured after the communication with the master station was established.	Cycle the power of the servo amplifier or reset the software to apply changes to the settings. For the IP address setting with engineering software, refer to IP address setting function via the master station in the following manual. <input type="checkbox"/> MR-J5-G/MR-J5W-G User's Manual (Communication Function)	[G]

[AL. 19D.2_IP address change failed warning 1]

Cause	Check/action method	Model
1. When [Pr. NPA01 IP address setting] is set to "0" (the rotary switch is used.) and the rotary switch is set to a value other than "0", the IP address setting with engineering software was configured.	Set [Pr. NPA01 IP address setting] to "1" (the network parameter is used.). Alternatively, configure the IP address setting after setting the rotary switch to "0". For the IP address setting with engineering software, refer to IP address setting function via the master station in the following manual. <input type="checkbox"/> MR-J5-G/MR-J5W-G User's Manual (Communication Function)	[G]

[AL. 19E_Network warning 2]

- An error exists in the network settings.

[AL. 19E.1_Parameter automatic backup setting warning]

Cause	Check/action method	Model
1. An error was detected in the parameter automatic backup setting.	Check if the master station supports power interruption protection. If power interruption protection is not supported, set [Pr. PN20 Parameter automatic backup update interval] to "0" to disable the automatic backup function.	[G]

[AL. 19E.2_Control mode setting warning 2]

Cause	Check/action method	Model
1. An unsupported control mode was used.	Check if the control mode corresponds to the communication cycle. For the correspondence between communication cycles and control modes, refer to "Restrictions on the MR-J5_-_G_" in the User's Manual (Introduction).	[G]
2. A control mode that does not support CC-Link IE TSN Class A was used.	Check if the control mode supports CC-Link IE TSN Class A. For the correspondence between CC-Link IE TSN Class A and control modes, refer to "Restrictions on CC-Link IE TSN Class A" in the User's Manual (Introduction).	

[AL. 19E.3_Safety communication setting warning]

Cause	Check/action method	Model
1. The safety communication setting of the controller has been enabled for a servo amplifier on which the safety communication has been disabled.	If not using the safety communication, disable the safety communication setting of the controller. If using the safety communication, enable the safety communication setting of the servo amplifier.	[G]

[AL. 19E.4_SSCNET communication error warning]

Cause	Check/action method	Model
1. The connected controller is not compatible with the MR-J5_-_B_.	Check if the controller is compatible with the MR-J5_-_B_.	[B]

[AL. 19E.5_Control mode transition warning]

Cause	Check/action method	Model
1. When an attempt to switch the control mode was made, the control mode transitioned to an unsupported one.	Check if both the control modes before and after the change are switchable ones. For switchable control modes, refer to "Drive profile" in the User's Manual (Communication Function).	[G]

[AL. 19E.6_Control mode switching waiting warning]

Cause	Check/action method	Model
1. The setting of [Pr. PW13.4 Control switching method setting] is incorrect.	Review the setting value of [Pr. PW13.4 Control switching method setting].	[G]
2. When an attempt to switch the control mode was made, the control mode did not transition.	Refer to the manual for the controller being used to check if the command value for switching the control mode is correct. When changing the timeout time for switching the control mode in the controller, set [Pr. PW38 Control mode switching waiting time] to twice the timeout time in the controller.	

[AL. 1BD_Driver communication warning]

- There is a problem with the settings of driver communication.

[AL. 1BD.1_Driver communication cycle setting warning]

Cause	Check/action method	Model
1. An unsupported driver communication cycle was set.	Review the settings on the controller side. Refer to "Driver communication specifications" in the User's Manual (Communication function).	[G]

[AL. 1BD.2_Driver communication - Number of cyclic points warning]

Cause	Check/action method	Model
1. A value larger than the maximum size was set to the cyclic points number.	Cycle the power of the servo amplifier whose driver communication setting is enabled, then set the objects of PDO Mapping Objects to the initial values.	[G]

[AL. 1BD.3_Driver communication - Command data setting warning]

Cause	Check/action method	Model
1. Command data transmission has been disabled.	☞ Page 165 [AL. 1BD.2_Driver communication - Number of cyclic points warning]	[G]

[AL. 1BD.4_Driver communication - Master-slave operation simultaneous stop setting warning]

Cause	Check/action method	Model
1. The master-slave operation simultaneous stop function has been disabled.	☞ Page 165 [AL. 1BD.2_Driver communication - Number of cyclic points warning]	[G]

[AL. 1E9_Open-phase warning]

- An open phase occurred in the main circuit power supply of the servo amplifier.

[AL. 1E9.1_Input open-phase warning]

Cause	Check/action method	Model
1. An open phase occurred in the main circuit power line of the servo amplifier.	 Page 155 [AL. 139.1_Input open-phase error]	[G] [B] [A]
2. For the MR-J5D_, input open-phase detection is enabled.	Set [Pr. PC20.4 Input open-phase detection selection] to "0" and cycle the power.	[G]

[AL. 1EA_Master-slave operation simultaneous stop warning]

- When the master-slave operation simultaneous stop function was enabled, the servo motor of the master or slave axis stopped.

[AL. 1EA.1_Master-slave operation stop command detection warning]

Cause	Check/action method	Model
1. The servo motor of the master axis stopped.	Remove the cause of the stop.	[G]

[AL. 1EA.2_Master-slave operation stop request detection warning]

Cause	Check/action method	Model
1. The servo motor of a slave axis stopped.	Remove the cause of the stop.	[G]

[AL. 1EB_Manufacturer setting error]

- Incorrect write operation was performed to an object.

[AL. 1EB.1_Manufacturer setting error]

Cause	Check/action method	Model
1. An incorrect value was written to an object for manufacturer setting.	Do not use objects for manufacturer setting.	[G]

[AL. 1EB.2_Manufacturer setting error]

Cause	Check/action method	Model
1. An incorrect value was written to an object for manufacturer setting.	Do not use objects for manufacturer setting.	[G]

[AL. 1EB.3_Manufacturer setting error]

Cause	Check/action method	Model
1. An incorrect value was written to an object for manufacturer setting.	Do not use objects for manufacturer setting.	[G]

[AL. 1F6_Manufacturer setting error]

- A value of the servo parameters for manufacturer setting has been set incorrectly.

[AL. 1F6.1_Manufacturer setting error]

Cause	Check/action method	Model
1. Values of the servo parameters for manufacturer setting have been changed.	Set the servo parameters for manufacturer setting to the initial values.	[G] [B] [A]

[AL. 1F6.2_Manufacturer setting error]

Cause	Check/action method	Model
1. Values of the servo parameters for manufacturer setting have been changed.	Set the servo parameters for manufacturer setting to the initial values.	[G] [B] [A]

[AL. 1F6.3_Manufacturer setting error]

Cause	Check/action method	Model
1. Values of the servo parameters for manufacturer setting have been changed.	Set the servo parameters for manufacturer setting to the initial values.	[G] [B] [A]

[AL. 1F6.4_Manufacturer setting error]

Cause	Check/action method	Model
1. Values of the servo parameters for manufacturer setting have been changed.	Set the servo parameters for manufacturer setting to the initial values.	[G] [B] [A]

[AL. 1F6.5_Manufacturer setting error]

Cause	Check/action method	Model
1. Values of the servo parameters for manufacturer setting have been changed.	Set the servo parameters for manufacturer setting to the initial values.	[G] [B] [A]

[AL. 1F6.6_Manufacturer setting error]

Cause	Check/action method	Model
1. Values of the servo parameters for manufacturer setting have been changed.	Set the servo parameters for manufacturer setting to the initial values.	[G] [B] [A]

[AL. 1F8_Memory warning 1]

- There is a memory error.

[AL. 1F8.1_Memory writing frequency warning]

Cause	Check/action method	Model
1. The frequency of writing to the memory exceeded the guaranteed number.	Prepare for replacing the servo amplifier by making a backup of necessary data or by other means. This warning can be disabled by [Pr. PF02.4 Memory writing frequency warning enable/disable selection]. The memory may be broken if the memory is used continuously while [Pr. PF02.4] is disabled.	[G] [B] [A]

[AL. 1F8.2_Memory free space warning]

Cause	Check/action method	Model
1. The available free space in the memory is insufficient.	Delete unnecessary files to free up the memory. If no files can be deleted, make a backup of necessary data such as parameters, then initialize the servo amplifier. Refer to "Servo amplifier setting initialization" or "Drive unit setting initialization" in the User's Manual (Introduction). This warning can be disabled by [Pr. PF02.5 Memory free space warning enable/disable selection]. [AL. 119.7 Memory free space error 4-1] may occur if the memory is used continuously while [Pr. PF02.5] is disabled.	[G] [B] [A]

[AL. 201 - 28F_Manufacturer setting error]

- A value of the servo parameters for manufacturer setting has been set incorrectly.

Cause	Check/action method	Model
1. Values of the servo parameters for manufacturer setting have been changed.	Set the servo parameters for manufacturer setting to the initial values.	[G] [A]

[AL. 290 - 2FF_Manufacturer setting warning]

- A value of the servo parameters for manufacturer setting has been set incorrectly.

Cause	Check/action method	Model
1. Values of the servo parameters for manufacturer setting have been changed.	Set the servo parameters for manufacturer setting to the initial values.	[G] [A]

[AL. 510_Voltage diagnosis error (safety sub-function)]

- There is a problem with the control circuit power supply voltage.

[AL. 510.1_Power supply voltage diagnosis error A1 (safety sub-function)]

Cause	Check/action method	Model
1. The power supply connection is incorrect.	Check the wiring. Refer to "SIGNALS AND WIRING" and "Example power circuit connections" in the following manuals. <input type="checkbox"/> MR-J5 User's Manual (Hardware) <input type="checkbox"/> MR-J5D User's Manual (Hardware)	[G]
2. The servo amplifier has malfunctioned.	Replace the servo amplifier.	
3. There is a problem with the surrounding environment.	Check the power supply for noise. If there is noise, take countermeasures to reduce the noise. Refer to "Noise reduction techniques" in the following manuals. <input type="checkbox"/> MR-J5 User's Manual (Hardware) <input type="checkbox"/> MR-J5D User's Manual (Hardware)	

[AL. 510.2_Power supply voltage diagnosis error A2 (safety sub-function)]

☞ Page 173 [AL. 510.1_Power supply voltage diagnosis error A1 (safety sub-function)]

[AL. 510.7_Power supply voltage diagnosis error A at startup (safety sub-function)]

☞ Page 173 [AL. 510.1_Power supply voltage diagnosis error A1 (safety sub-function)]

[AL. 510.9_Power supply voltage diagnosis error B1 (safety sub-function)]

☞ Page 173 [AL. 510.1_Power supply voltage diagnosis error A1 (safety sub-function)]

[AL. 510.A_Power supply voltage diagnosis error B2 (safety sub-function)]

☞ Page 173 [AL. 510.1_Power supply voltage diagnosis error A1 (safety sub-function)]

[AL. 510.B_Power supply voltage diagnosis error B3 (safety sub-function)]

☞ Page 173 [AL. 510.1_Power supply voltage diagnosis error A1 (safety sub-function)]

[AL. 510.C_Power supply voltage diagnosis error B4 (safety sub-function)]

☞ Page 173 [AL. 510.1_Power supply voltage diagnosis error A1 (safety sub-function)]

[AL. 510.D_Power supply voltage diagnosis error B5 (safety sub-function)]

☞ Page 173 [AL. 510.1_Power supply voltage diagnosis error A1 (safety sub-function)]

[AL. 510.E_Power supply voltage diagnosis error B6 (safety sub-function)]

☞ Page 173 [AL. 510.1_Power supply voltage diagnosis error A1 (safety sub-function)]



[AL. 510.F_Power supply voltage diagnosis error B at startup (safety sub-function)]

☞ Page 173 [AL. 510.1_Power supply voltage diagnosis error A1 (safety sub-function)]

[AL. 512_Memory error 1 (RAM) (safety sub-function)]

- The internal part of the servo amplifier (RAM) has malfunctioned.

[AL. 512.2_RAM diagnosis error A2 (safety sub-function)]

Cause	Check/action method	Model
1. An internal part of the servo amplifier has malfunctioned.	Noise from the power supply may have caused the failure. Disconnect all cables except for those for the control circuit power supply, then check the repeatability. If the failure continues, the servo amplifier may have malfunctioned. Replace the servo amplifier.	[G]
2. There is a problem with the surrounding environment.	Check the power supply for noise. If there is noise, take countermeasures to reduce the noise. Refer to "Noise reduction techniques" in the following manuals.  MR-J5 User's Manual (Hardware)  MR-J5D User's Manual (Hardware)	

[AL. 512.3_RAM diagnosis error A3 (safety sub-function)]

 Page 174 [AL. 512.2_RAM diagnosis error A2 (safety sub-function)]

[AL. 512.A_RAM diagnosis error B2 (safety sub-function)]

 Page 174 [AL. 512.2_RAM diagnosis error A2 (safety sub-function)]

[AL. 512.B_RAM diagnosis error B3 (safety sub-function)]

 Page 174 [AL. 512.2_RAM diagnosis error A2 (safety sub-function)]

[AL. 514_Control process error (safety sub-function)]

- The process did not complete within the specified time.

[AL. 514.9_Control process error B (safety sub-function)]

Cause	Check/action method	Model
1. The servo parameter settings are incorrect.	Return the servo parameter to the value it had before the alarm occurrence, then check if the problem occurs again.	[G]
2. An internal part of the servo amplifier has malfunctioned.	Replace the servo amplifier.	
3. There is a problem with the surrounding environment.	Check the power supply for noise. If there is noise, take countermeasures to reduce the noise. Refer to "Noise reduction techniques" in the following manuals. <ul style="list-style-type: none"> 📖 MR-J5 User's Manual (Hardware) 📖 MR-J5D User's Manual (Hardware) 	

[AL. 514.A_Control process error B2 (safety sub-function)]

📖 Page 175 [AL. 514.9_Control process error B (safety sub-function)]

[AL. 515_Memory error 2 (ROM) (safety sub-function)]

- The internal part of the servo amplifier (ROM) has malfunctioned.

[AL. 515.9_ROM error B at power-on (safety sub-function)]

Cause	Check/action method	Model
1. There is a problem with operation of ROM at power-on.	Noise from the power supply may have caused the failure. Disconnect all cables except for those for the control circuit power supply, then check the repeatability. If the failure continues, the servo amplifier may have malfunctioned. Replace the servo amplifier.	[G]
2. There is a problem with the surrounding environment.	Check the power supply for noise. If there is noise, take countermeasures to reduce the noise. Refer to "Noise reduction techniques" in the following manuals. <ul style="list-style-type: none"> ☞ MR-J5 User's Manual (Hardware) ☞ MR-J5D User's Manual (Hardware) 	
3. The frequency of writing exceeded 100,000.	Check if excessively frequent changes have been made to parameters, then replace the servo amplifier. After replacing the servo amplifier, adjust the processing so as to reduce the number of times changes are made to parameters.	

[AL. 515.A_ROM error B during operation (safety sub-function)]

Cause	Check/action method	Model
1. There is a problem with operation of ROM in normal operation.	Check if this alarm occurs when changing a parameter during normal operation. If the alarm occurs, replace the controller.	[G]
2. Take actions according to the instructions of 2. to 3. in the following item. <ul style="list-style-type: none"> ☞ Page 176 [AL. 515.9_ROM error B at power-on (safety sub-function)] 		

[AL. 516_ Encoder initial communication error 1 (safety sub-function)]

- There is a communication error between the encoder and servo amplifier.

[AL. 516.1_ Encoder initial communication - Receive data error A1 (safety sub-function)]

Cause	Check/action method	Model
1. There is a problem with the encoder cable.	Check if the encoder cable has been disconnected or has shorted. If there is a problem with the cable, repair or replace the cable.	[G]
2. The encoder has malfunctioned.	Replace the servo motor.	
3. The servo amplifier has malfunctioned.	Replace the servo amplifier.	
4. There is a problem with the surrounding environment.	Check the power supply for noise. If there is noise, take countermeasures to reduce the noise. Refer to "Noise reduction techniques" in the following manuals. <input type="checkbox"/> MR-J5 User's Manual (Hardware) <input type="checkbox"/> MR-J5D User's Manual (Hardware)	

[AL. 516.2_ Encoder initial communication - Receive data error A2 (safety sub-function)]

☞ Page 177 [AL. 516.1_ Encoder initial communication - Receive data error A1 (safety sub-function)]

[AL. 516.3_ Encoder initial communication - Receive data error A3 (safety sub-function)]

☞ Page 177 [AL. 516.1_ Encoder initial communication - Receive data error A1 (safety sub-function)]

[AL. 516.4_ Encoder initial communication - Receive data error A4 (safety sub-function)]

☞ Page 177 [AL. 516.1_ Encoder initial communication - Receive data error A1 (safety sub-function)]

[AL. 516.5_ Encoder initial communication - Receive data error A5 (safety sub-function)]

☞ Page 177 [AL. 516.1_ Encoder initial communication - Receive data error A1 (safety sub-function)]

[AL. 516.9_ Encoder initial communication - Receive data error B1 (safety sub-function)]

☞ Page 177 [AL. 516.1_ Encoder initial communication - Receive data error A1 (safety sub-function)]

[AL. 516.A_ Encoder initial communication - Receive data error B2 (safety sub-function)]

☞ Page 177 [AL. 516.1_ Encoder initial communication - Receive data error A1 (safety sub-function)]

[AL. 516.B_ Encoder initial communication - Receive data error B3 (safety sub-function)]

☞ Page 177 [AL. 516.1_ Encoder initial communication - Receive data error A1 (safety sub-function)]

[AL. 516.C_ Encoder initial communication - Receive data error B4 (safety sub-function)]

☞ Page 177 [AL. 516.1_ Encoder initial communication - Receive data error A1 (safety sub-function)]



[AL. 516.D_ Encoder initial communication - Receive data error B5 (safety sub-function)]

☞ Page 177 [AL. 516.1_ Encoder initial communication - Receive data error A1 (safety sub-function)]

[AL. 517_Board error (safety sub-function)]

- There is a problem with an internal part of the servo amplifier.

[AL. 517.2_Board error A2 (safety sub-function)]

Cause	Check/action method	Model
1. An internal part of the servo amplifier has malfunctioned.	Replace the servo amplifier.	[G]
2. There is a problem with the surrounding environment.	Check the noise, ambient temperature, and other conditions, and implement appropriate countermeasures for the cause. If there is noise, take countermeasures to reduce the noise. Refer to "Noise reduction techniques" in the following manuals.  MR-J5 User's Manual (Hardware)  MR-J5D User's Manual (Hardware)	

[AL. 517.9_Board error B1 (safety sub-function)]

 Page 178 [AL. 517.2_Board error A2 (safety sub-function)]

[AL. 518_Synchronous control error (safety sub-function)]

- There is a problem with an internal part of the servo amplifier.

[AL. 518.2_Synchronous control error A2 (safety sub-function)]

Cause	Check/action method	Model
1. An internal part of the servo amplifier has malfunctioned.	Replace the servo amplifier.	[G]
2. There is a problem with the surrounding environment.	Check the power supply for noise. If there is noise, take countermeasures to reduce the noise. Refer to "Noise reduction techniques" in the following manuals. <ul style="list-style-type: none"> 📖 MR-J5 User's Manual (Hardware) 📖 MR-J5D User's Manual (Hardware) 	



[AL. 518.A_Synchronous control error B2 (safety sub-function)]

📖 Page 179 [AL. 518.2_Synchronous control error A2 (safety sub-function)]

[AL. 519_Memory error 3 (Flash-ROM) (safety sub-function)]

- There is a problem with an internal part of the servo amplifier.

[AL. 519.2_Flash-ROM error A2 (safety sub-function)]

Cause	Check/action method	Model
1. The Flash-ROM has malfunctioned.	Noise from the power supply may have caused the failure. Disconnect all cables except for those for the control circuit power supply, then check the repeatability. If the failure continues, the servo amplifier may have malfunctioned. Replace the servo amplifier.	[G]
2. There is a problem with the surrounding environment.	Check the power supply for noise. If there is noise, take countermeasures to reduce the noise. Refer to "Noise reduction techniques" in the following manuals.  MR-J5 User's Manual (Hardware)  MR-J5D User's Manual (Hardware)	

[AL. 519.A_Flash-ROM error B2 (safety sub-function)]

 Page 180 [AL. 519.2_Flash-ROM error A2 (safety sub-function)]

[AL. 520_ Encoder normal communication diagnosis error 1 (safety sub-function)]

- There is a communication error between the encoder and servo amplifier.

[AL. 520.1_ Encoder normal communication 1 - Receive data error A1 (safety sub-function)]

☞ Page 177 [AL. 516.1_ Encoder initial communication - Receive data error A1 (safety sub-function)]

[AL. 520.2_ Encoder normal communication 1 - Receive data error A2 (safety sub-function)]

☞ Page 177 [AL. 516.1_ Encoder initial communication - Receive data error A1 (safety sub-function)]

[AL. 520.3_ Encoder normal communication 1 - Receive data error A3 (safety sub-function)]

☞ Page 177 [AL. 516.1_ Encoder initial communication - Receive data error A1 (safety sub-function)]

[AL. 520.4_ Encoder normal communication 1 - Receive data error A4 (safety sub-function)]

☞ Page 177 [AL. 516.1_ Encoder initial communication - Receive data error A1 (safety sub-function)]

[AL. 520.9_ Encoder normal communication 1 - Receive data error B1 (safety sub-function)]

☞ Page 177 [AL. 516.1_ Encoder initial communication - Receive data error A1 (safety sub-function)]

[AL. 520.A_ Encoder normal communication 1 - Receive data error B2 (safety sub-function)]

☞ Page 177 [AL. 516.1_ Encoder initial communication - Receive data error A1 (safety sub-function)]

[AL. 520.B_ Encoder normal communication 1 - Receive data error B3 (safety sub-function)]

☞ Page 177 [AL. 516.1_ Encoder initial communication - Receive data error A1 (safety sub-function)]

[AL. 520.C_ Encoder normal communication 1 - Receive data error B4 (safety sub-function)]

☞ Page 177 [AL. 516.1_ Encoder initial communication - Receive data error A1 (safety sub-function)]

[AL. 521_ Encoder normal communication diagnosis error 2 (safety sub-function)]

- The encoder detected an error signal.

[AL. 521.1_ Encoder normal communication 2 - Diagnosis error A1 (safety sub-function)]

Cause	Check/action method	Model
1. The voltage of the control circuit power supply has become unstable.	Check the voltage of the control circuit power supply. If an instantaneous power failure is occurring in the control circuit power supply, review the power supply environment.	[G]
2. Take actions in accordance with the items shown below. ☞ Page 177 [AL. 516.1_ Encoder initial communication - Receive data error A1 (safety sub-function)]		

[AL. 521.2_ Encoder normal communication 2 - Diagnosis error A2 (safety sub-function)]

☞ Page 182 [AL. 521.1_ Encoder normal communication 2 - Diagnosis error A1 (safety sub-function)]

[AL. 521.3_ Encoder normal communication 2 - Diagnosis error A3 (safety sub-function)]

☞ Page 182 [AL. 521.1_ Encoder normal communication 2 - Diagnosis error A1 (safety sub-function)]

[AL. 521.9_ Encoder normal communication 2 - Diagnosis error B1 (safety sub-function)]

☞ Page 182 [AL. 521.1_ Encoder normal communication 2 - Diagnosis error A1 (safety sub-function)]

[AL. 521.A_ Encoder normal communication 2 - Diagnosis error B2 (safety sub-function)]

☞ Page 182 [AL. 521.1_ Encoder normal communication 2 - Diagnosis error A1 (safety sub-function)]

[AL. 521.B_ Encoder normal communication 2 - Diagnosis error B3 (safety sub-function)]

☞ Page 182 [AL. 521.1_ Encoder normal communication 2 - Diagnosis error A1 (safety sub-function)]

[AL. 522_ Encoder normal communication diagnosis error 3 (safety sub-function)]

- The encoder detected an error signal.

[AL. 522.1_ Encoder normal communication 3 - Diagnosis error A1 (safety sub-function)]

☞ Page 177 [AL. 516.1_ Encoder initial communication - Receive data error A1 (safety sub-function)]

[AL. 522.2_ Encoder normal communication 3 - Diagnosis error A2 (safety sub-function)]

☞ Page 177 [AL. 516.1_ Encoder initial communication - Receive data error A1 (safety sub-function)]

[AL. 522.3_ Encoder normal communication 3 - Diagnosis error A3 (safety sub-function)]

☞ Page 177 [AL. 516.1_ Encoder initial communication - Receive data error A1 (safety sub-function)]

[AL. 522.4_ Encoder normal communication 3 - Diagnosis error A4 (safety sub-function)]

☞ Page 177 [AL. 516.1_ Encoder initial communication - Receive data error A1 (safety sub-function)]

[AL. 522.9_ Encoder normal communication 3 - Diagnosis error B1 (safety sub-function)]

☞ Page 177 [AL. 516.1_ Encoder initial communication - Receive data error A1 (safety sub-function)]

[AL. 522.A_ Encoder normal communication 3 - Diagnosis error B2 (safety sub-function)]

☞ Page 177 [AL. 516.1_ Encoder initial communication - Receive data error A1 (safety sub-function)]

[AL. 522.B_ Encoder normal communication 3 - Diagnosis error B3 (safety sub-function)]

☞ Page 177 [AL. 516.1_ Encoder initial communication - Receive data error A1 (safety sub-function)]

[AL. 522.C_ Encoder normal communication 3 - Diagnosis error B4 (safety sub-function)]

☞ Page 177 [AL. 516.1_ Encoder initial communication - Receive data error A1 (safety sub-function)]

[AL. 523_ Encoder normal communication diagnosis error 4 (safety sub-function)]

- The encoder detected an error signal.

[AL. 523.1_ Encoder normal communication 4 - Diagnosis error A1 (safety sub-function)]

Cause	Check/action method	Model
1. The encoder has malfunctioned.	Replace the servo motor.	[G]

[AL. 523.2_ Encoder normal communication 4 - Diagnosis error A2 (safety sub-function)]

☞ Page 183 [AL. 522.1_ Encoder normal communication 3 - Diagnosis error A1 (safety sub-function)]

[AL. 523.3_ Encoder normal communication 4 - Diagnosis error A3 (safety sub-function)]

☞ Page 183 [AL. 522.1_ Encoder normal communication 3 - Diagnosis error A1 (safety sub-function)]

[AL. 523.4_ Encoder normal communication 4 - Diagnosis error A4 (safety sub-function)]

☞ Page 183 [AL. 522.1_ Encoder normal communication 3 - Diagnosis error A1 (safety sub-function)]

[AL. 523.9_ Encoder normal communication 4 - Diagnosis error B1 (safety sub-function)]

☞ Page 183 [AL. 522.1_ Encoder normal communication 3 - Diagnosis error A1 (safety sub-function)]

[AL. 523.A_ Encoder normal communication 4 - Diagnosis error B2 (safety sub-function)]

☞ Page 183 [AL. 522.1_ Encoder normal communication 3 - Diagnosis error A1 (safety sub-function)]

[AL. 523.B_ Encoder normal communication 4 - Diagnosis error B3 (safety sub-function)]

☞ Page 183 [AL. 522.1_ Encoder normal communication 3 - Diagnosis error A1 (safety sub-function)]

[AL. 523.C_ Encoder normal communication 4 - Diagnosis error B4 (safety sub-function)]

☞ Page 183 [AL. 522.1_ Encoder normal communication 3 - Diagnosis error A1 (safety sub-function)]

[AL. 524_ Encoder normal communication diagnosis error 5 (safety sub-function)]

- The encoder detected an error signal.

[AL. 524.1_ Encoder normal communication 5 - Diagnosis error A1 (safety sub-function)]

☞ Page 183 [AL. 522.1_ Encoder normal communication 3 - Diagnosis error A1 (safety sub-function)]

[AL. 524.2_ Encoder normal communication 5 - Diagnosis error A2 (safety sub-function)]

☞ Page 183 [AL. 522.1_ Encoder normal communication 3 - Diagnosis error A1 (safety sub-function)]

[AL. 524.3_ Encoder normal communication 5 - Diagnosis error A3 (safety sub-function)]

☞ Page 183 [AL. 522.1_ Encoder normal communication 3 - Diagnosis error A1 (safety sub-function)]

[AL. 524.4_ Encoder normal communication 5 - Diagnosis error A4 (safety sub-function)]

☞ Page 183 [AL. 522.1_ Encoder normal communication 3 - Diagnosis error A1 (safety sub-function)]

[AL. 524.9_ Encoder normal communication 5 - Diagnosis error B1 (safety sub-function)]

☞ Page 183 [AL. 522.1_ Encoder normal communication 3 - Diagnosis error A1 (safety sub-function)]

[AL. 524.A_ Encoder normal communication 5 - Diagnosis error B2 (safety sub-function)]

☞ Page 183 [AL. 522.1_ Encoder normal communication 3 - Diagnosis error A1 (safety sub-function)]

[AL. 524.B_ Encoder normal communication 5 - Diagnosis error B3 (safety sub-function)]

☞ Page 183 [AL. 522.1_ Encoder normal communication 3 - Diagnosis error A1 (safety sub-function)]

[AL. 524.C_ Encoder normal communication 5 - Diagnosis error B4 (safety sub-function)]

☞ Page 183 [AL. 522.1_ Encoder normal communication 3 - Diagnosis error A1 (safety sub-function)]

[AL. 525_Encoder normal communication diagnosis error 6 (safety sub-function)]

- The encoder detected an error signal.

[AL. 525.1_Encoder normal communication 6 - Diagnosis error A1 (safety sub-function)]

☞ Page 183 [AL. 522.1_Encoder normal communication 3 - Diagnosis error A1 (safety sub-function)]

[AL. 525.2_Encoder normal communication 6 - Diagnosis error A2 (safety sub-function)]

☞ Page 183 [AL. 522.1_Encoder normal communication 3 - Diagnosis error A1 (safety sub-function)]

[AL. 525.3_Encoder normal communication 6 - Diagnosis error A3 (safety sub-function)]

☞ Page 183 [AL. 522.1_Encoder normal communication 3 - Diagnosis error A1 (safety sub-function)]

[AL. 525.4_Encoder normal communication 6 - Diagnosis error A4 (safety sub-function)]

☞ Page 183 [AL. 522.1_Encoder normal communication 3 - Diagnosis error A1 (safety sub-function)]

[AL. 525.9_Encoder normal communication 6 - Diagnosis error B1 (safety sub-function)]

☞ Page 183 [AL. 522.1_Encoder normal communication 3 - Diagnosis error A1 (safety sub-function)]

[AL. 525.A_Encoder normal communication 6 - Diagnosis error B2 (safety sub-function)]

☞ Page 183 [AL. 522.1_Encoder normal communication 3 - Diagnosis error A1 (safety sub-function)]

[AL. 525.B_Encoder normal communication 6 - Diagnosis error B3 (safety sub-function)]

☞ Page 183 [AL. 522.1_Encoder normal communication 3 - Diagnosis error A1 (safety sub-function)]

[AL. 525.C_Encoder normal communication 6 - Diagnosis error B4 (safety sub-function)]

☞ Page 183 [AL. 522.1_Encoder normal communication 3 - Diagnosis error A1 (safety sub-function)]

[AL. 526_ Encoder normal communication diagnosis error 7 (safety sub-function)]

- The encoder detected an error signal.

[AL. 526.1_ Encoder normal communication 7 - Diagnosis error A1 (safety sub-function)]

☞ Page 183 [AL. 522.1_ Encoder normal communication 3 - Diagnosis error A1 (safety sub-function)]

[AL. 526.2_ Encoder normal communication 7 - Diagnosis error A2 (safety sub-function)]

☞ Page 183 [AL. 522.1_ Encoder normal communication 3 - Diagnosis error A1 (safety sub-function)]

[AL. 526.3_ Encoder normal communication 7 - Diagnosis error A3 (safety sub-function)]

☞ Page 183 [AL. 522.1_ Encoder normal communication 3 - Diagnosis error A1 (safety sub-function)]

[AL. 526.4_ Encoder normal communication 7 - Diagnosis error A4 (safety sub-function)]

☞ Page 183 [AL. 522.1_ Encoder normal communication 3 - Diagnosis error A1 (safety sub-function)]

[AL. 526.9_ Encoder normal communication 7 - Diagnosis error B1 (safety sub-function)]

☞ Page 183 [AL. 522.1_ Encoder normal communication 3 - Diagnosis error A1 (safety sub-function)]

[AL. 526.A_ Encoder normal communication 7 - Diagnosis error B2 (safety sub-function)]

☞ Page 183 [AL. 522.1_ Encoder normal communication 3 - Diagnosis error A1 (safety sub-function)]

[AL. 526.B_ Encoder normal communication 7 - Diagnosis error B3 (safety sub-function)]

☞ Page 183 [AL. 522.1_ Encoder normal communication 3 - Diagnosis error A1 (safety sub-function)]

[AL. 526.C_ Encoder normal communication 7 - Diagnosis error B4 (safety sub-function)]

☞ Page 183 [AL. 522.1_ Encoder normal communication 3 - Diagnosis error A1 (safety sub-function)]

[AL. 527_ Encoder normal communication diagnosis error 8 (safety sub-function)]

- The encoder detected an error signal.

[AL. 527.1_ Encoder normal communication 8 - Diagnosis error A1 (safety sub-function)]

☞ Page 183 [AL. 522.1_ Encoder normal communication 3 - Diagnosis error A1 (safety sub-function)]

[AL. 527.2_ Encoder normal communication 8 - Diagnosis error A2 (safety sub-function)]

☞ Page 183 [AL. 522.1_ Encoder normal communication 3 - Diagnosis error A1 (safety sub-function)]

[AL. 527.3_ Encoder normal communication 8 - Diagnosis error A3 (safety sub-function)]

☞ Page 183 [AL. 522.1_ Encoder normal communication 3 - Diagnosis error A1 (safety sub-function)]

[AL. 527.4_ Encoder normal communication 8 - Diagnosis error A4 (safety sub-function)]

☞ Page 183 [AL. 522.1_ Encoder normal communication 3 - Diagnosis error A1 (safety sub-function)]

[AL. 527.9_ Encoder normal communication 8 - Diagnosis error B1 (safety sub-function)]

☞ Page 183 [AL. 522.1_ Encoder normal communication 3 - Diagnosis error A1 (safety sub-function)]

[AL. 527.A_ Encoder normal communication 8 - Diagnosis error B2 (safety sub-function)]

☞ Page 183 [AL. 522.1_ Encoder normal communication 3 - Diagnosis error A1 (safety sub-function)]

[AL. 527.B_ Encoder normal communication 8 - Diagnosis error B3 (safety sub-function)]

☞ Page 183 [AL. 522.1_ Encoder normal communication 3 - Diagnosis error A1 (safety sub-function)]

[AL. 527.C_ Encoder normal communication 8 - Diagnosis error B4 (safety sub-function)]

☞ Page 183 [AL. 522.1_ Encoder normal communication 3 - Diagnosis error A1 (safety sub-function)]

[AL. 528_ Encoder normal communication diagnosis error 9 (safety sub-function)]

- The encoder detected an error signal.

[AL. 528.1_ Encoder normal communication 9 - Diagnosis error A1 (safety sub-function)]

☞ Page 183 [AL. 522.1_ Encoder normal communication 3 - Diagnosis error A1 (safety sub-function)]

[AL. 528.2_ Encoder normal communication 9 - Diagnosis error A2 (safety sub-function)]

☞ Page 183 [AL. 522.1_ Encoder normal communication 3 - Diagnosis error A1 (safety sub-function)]

[AL. 528.3_ Encoder normal communication 9 - Diagnosis error A3 (safety sub-function)]

☞ Page 183 [AL. 522.1_ Encoder normal communication 3 - Diagnosis error A1 (safety sub-function)]

[AL. 528.4_ Encoder normal communication 9 - Diagnosis error A4 (safety sub-function)]

☞ Page 183 [AL. 522.1_ Encoder normal communication 3 - Diagnosis error A1 (safety sub-function)]

[AL. 528.9_ Encoder normal communication 9 - Diagnosis error B1 (safety sub-function)]

☞ Page 183 [AL. 522.1_ Encoder normal communication 3 - Diagnosis error A1 (safety sub-function)]

[AL. 528.A_ Encoder normal communication 9 - Diagnosis error B2 (safety sub-function)]

☞ Page 183 [AL. 522.1_ Encoder normal communication 3 - Diagnosis error A1 (safety sub-function)]

[AL. 528.B_ Encoder normal communication 9 - Diagnosis error B3 (safety sub-function)]

☞ Page 183 [AL. 522.1_ Encoder normal communication 3 - Diagnosis error A1 (safety sub-function)]

[AL. 528.C_ Encoder normal communication 9 - Diagnosis error B4 (safety sub-function)]

☞ Page 183 [AL. 522.1_ Encoder normal communication 3 - Diagnosis error A1 (safety sub-function)]

[AL. 529_Encoder data error (safety sub-function)]

- There is an error in the data of the encoder.

[AL. 529.1_Encoder position data error A (safety sub-function)]

☞ Page 183 [AL. 522.1_Encoder normal communication 3 - Diagnosis error A1 (safety sub-function)]

[AL. 529.9_Encoder position data error B (safety sub-function)]

☞ Page 183 [AL. 522.1_Encoder normal communication 3 - Diagnosis error A1 (safety sub-function)]

[AL. 52A_Position feedback error (safety sub-function)]

- There is an error in the data of the encoder.

[AL. 52A.1_Position feedback diagnosis error A (safety sub-function)]

Cause	Check/action method	Model
1. The position feedback data does not change within the time set in [Pr. PSA22 Position feedback error detection time].	Review the setting of [Pr. PSA22]. Alternatively, operate the system within the time set in [Pr. PSA22].	[G]
2. The servo motor has malfunctioned.	If the position feedback does not change even when the servo motor is driven, replace the servo motor.	
3. The servo amplifier has malfunctioned.	Replace the servo amplifier.	

[AL. 52A.9_Position feedback diagnosis error B (safety sub-function)]

☞ Page 191 [AL. 52A.1_Position feedback diagnosis error A (safety sub-function)]

[AL. 52B_ Encoder thermal error (safety sub-function)]

- There is a problem with the internal temperature of the encoder.

[AL. 52B.1_ Encoder thermal error A (safety sub-function)]

Cause	Check/action method	Model
1. The ambient temperature of the servo motor has exceeded the specified value.	Check the ambient temperature, and if the temperature exceeds the specified value, lower the ambient temperature.	[G]
2. The ambient temperature of the servo motor has fallen below the specified value.	Check the ambient temperature, and if the temperature has fallen below the specified value, raise the ambient temperature.	
3. The servo motor is overloaded.	Reduce the load or review the operation pattern.	
4. The thermal sensor in the encoder has malfunctioned.	Replace the servo motor.	
5. The servo amplifier has malfunctioned.	Replace the servo amplifier.	

[AL. 52B.9_ Encoder thermal error B (safety sub-function)]

☞ Page 192 [AL. 52B.1_ Encoder thermal error A (safety sub-function)]

[AL. 537_Parameter setting range error (safety sub-function)]

- There is an error in a functional safety parameter.

[AL. 537.1_Parameter setting range error A (safety sub-function)]

Cause	Check/action method	Model
1. A functional safety parameter was set outside of the setting range.	Check the parameter error No. on the alarm display screen of MR Configurator2 or with another method, then review the setting value of the functional safety parameter.	[G]

[AL. 537.2_Parameter combination error A (safety sub-function)]

Cause	Check/action method	Model
1. A servo parameter or a functional safety parameter has been set incorrectly.	Check the parameter error No. on the alarm display screen of MR Configurator2 or with another method, then review the setting value of the servo parameter or the functional safety parameter. Refer to "Parameter combinations that trigger [AL. 537.2 Parameter combination error A (safety sub-function)]" in the following manual.  MR-J5 User's Manual (Function)	[G]

[AL. 537.3_Parameter setting error A (safety sub-function)]

Cause	Check/action method	Model
1. A functional safety parameter failed to be set properly.	Check the parameter error No. on the alarm display screen of MR Configurator2 or with another method, then review the setting value of the functional safety parameter.	[G]

[AL. 537.9_Parameter setting range error B (safety sub-function)]

 Page 193 [AL. 537.1_Parameter setting range error A (safety sub-function)]

[AL. 537.A_Parameter combination error B (safety sub-function)]

 Page 193 [AL. 537.2_Parameter combination error A (safety sub-function)]

[AL. 53A_Parameter verification error (safety sub-function)]

- An error occurred in the functional safety parameter.

[AL. 53A.2_Parameter verification error A2 (safety sub-function)]

Cause	Check/action method	Model
1. There is a problem with the functional safety parameter settings.	Confirm which parameter has an error by using MR Configurator2, then set the parameter correctly.	[G]
2. The servo amplifier has malfunctioned.	Replace the servo amplifier.	

[AL. 53A.A_Parameter verification error B2 (safety sub-function)]

Page 194 [AL. 53A.2_Parameter verification error A2 (safety sub-function)]

[AL. 540_ Internal diagnosis error 1 (safety sub-function)]

- There is an error in the result from the functional safety diagnosis.

[AL. 540.1_ Internal diagnosis error 1 - Data error A1 (safety sub-function)]

Cause	Check/action method	Model
1. The servo amplifier has malfunctioned.	Replace the servo amplifier.	[G]
2. There is a problem with the surrounding environment.	Check the power supply for noise. If there is noise, take countermeasures to reduce the noise. Refer to "Noise reduction techniques" in the following manuals. <ul style="list-style-type: none"> ☐ MR-J5 User's Manual (Hardware) ☐ MR-J5D User's Manual (Hardware) 	

[AL. 540.2_ Internal diagnosis error 1 - Data error A2 (safety sub-function)]

☞ Page 195 [AL. 540.1_ Internal diagnosis error 1 - Data error A1 (safety sub-function)]

[AL. 540.3_ Internal diagnosis error 1 - Data error A3 (safety sub-function)]

☞ Page 195 [AL. 540.1_ Internal diagnosis error 1 - Data error A1 (safety sub-function)]

[AL. 540.4_ Internal diagnosis error 1 - Data error A4 (safety sub-function)]

☞ Page 195 [AL. 540.1_ Internal diagnosis error 1 - Data error A1 (safety sub-function)]

[AL. 540.9_ Internal diagnosis error 1 - Data error B1 (safety sub-function)]

☞ Page 195 [AL. 540.1_ Internal diagnosis error 1 - Data error A1 (safety sub-function)]

[AL. 540.A_ Internal diagnosis error 1 - Data error B2 (safety sub-function)]

☞ Page 195 [AL. 540.1_ Internal diagnosis error 1 - Data error A1 (safety sub-function)]

[AL. 541_ Internal diagnosis error 2 (safety sub-function)]

- There is an error in the result from the functional safety diagnosis.

[AL. 541.1_ Internal diagnosis error 2 - Data error A1 (safety sub-function)]

☞ Page 195 [AL. 540.1_ Internal diagnosis error 1 - Data error A1 (safety sub-function)]

[AL. 541.2_ Internal diagnosis error 2 - Data error A2 (safety sub-function)]

☞ Page 195 [AL. 540.1_ Internal diagnosis error 1 - Data error A1 (safety sub-function)]

[AL. 541.3_ Internal diagnosis error 2 - Data error A3 (safety sub-function)]

☞ Page 195 [AL. 540.1_ Internal diagnosis error 1 - Data error A1 (safety sub-function)]

[AL. 541.4_ Internal diagnosis error 2 - Data error A4 (safety sub-function)]

☞ Page 195 [AL. 540.1_ Internal diagnosis error 1 - Data error A1 (safety sub-function)]

[AL. 541.5_ Internal diagnosis error 2 - Data error A5 (safety sub-function)]

☞ Page 195 [AL. 540.1_ Internal diagnosis error 1 - Data error A1 (safety sub-function)]

[AL. 541.9_ Internal diagnosis error 2 - Data error B1 (safety sub-function)]

☞ Page 195 [AL. 540.1_ Internal diagnosis error 1 - Data error A1 (safety sub-function)]

[AL. 541.A_ Internal diagnosis error 2 - Data error B2 (safety sub-function)]

☞ Page 195 [AL. 540.1_ Internal diagnosis error 1 - Data error A1 (safety sub-function)]

[AL. 541.B_ Internal diagnosis error 2 - Data error B3 (safety sub-function)]

☞ Page 195 [AL. 540.1_ Internal diagnosis error 1 - Data error A1 (safety sub-function)]

[AL. 541.C_ Internal diagnosis error 2 - Data error B4 (safety sub-function)]

☞ Page 195 [AL. 540.1_ Internal diagnosis error 1 - Data error A1 (safety sub-function)]

[AL. 541.D_ Internal diagnosis error 2 - Data error B5 (safety sub-function)]

☞ Page 195 [AL. 540.1_ Internal diagnosis error 1 - Data error A1 (safety sub-function)]

[AL. 542_Internal diagnosis error 3 (safety sub-function)]

- There is an error in the result from the functional safety diagnosis.

[AL. 542.1_Internal diagnosis error 3 - Data error A1 (safety sub-function)]

☞ Page 195 [AL. 540.1_Internal diagnosis error 1 - Data error A1 (safety sub-function)]

[AL. 542.9_Internal diagnosis error 3 - Data error B1 (safety sub-function)]

☞ Page 195 [AL. 540.1_Internal diagnosis error 1 - Data error A1 (safety sub-function)]

[AL. 543_ Internal diagnosis error 4 (safety sub-function)]

- There is an error in the result from the functional safety diagnosis.

[AL. 543.1_ Internal diagnosis error 4 - Data error A1 (safety sub-function)]

☞ Page 195 [AL. 540.1_ Internal diagnosis error 1 - Data error A1 (safety sub-function)]

[AL. 543.2_ Internal diagnosis error 4 - Data error A2 (safety sub-function)]

☞ Page 195 [AL. 540.1_ Internal diagnosis error 1 - Data error A1 (safety sub-function)]

[AL. 543.3_ Internal diagnosis error 4 - Data error A3 (safety sub-function)]

☞ Page 195 [AL. 540.1_ Internal diagnosis error 1 - Data error A1 (safety sub-function)]

[AL. 543.9_ Internal diagnosis error 4 - Data error B1 (safety sub-function)]

☞ Page 195 [AL. 540.1_ Internal diagnosis error 1 - Data error A1 (safety sub-function)]

[AL. 543.A_ Internal diagnosis error 4 - Data error B2 (safety sub-function)]

☞ Page 195 [AL. 540.1_ Internal diagnosis error 1 - Data error A1 (safety sub-function)]

[AL. 543.B_ Internal diagnosis error 4 - Data error B3 (safety sub-function)]

☞ Page 195 [AL. 540.1_ Internal diagnosis error 1 - Data error A1 (safety sub-function)]

[AL. 543.C_ Internal diagnosis error 4 - Data error B4 (safety sub-function)]

☞ Page 195 [AL. 540.1_ Internal diagnosis error 1 - Data error A1 (safety sub-function)]

[AL. 543.D_ Internal diagnosis error 4 - Data error B5 (safety sub-function)]

☞ Page 195 [AL. 540.1_ Internal diagnosis error 1 - Data error A1 (safety sub-function)]

[AL. 543.E_ Internal diagnosis error 4 - Data error B6 (safety sub-function)]

☞ Page 195 [AL. 540.1_ Internal diagnosis error 1 - Data error A1 (safety sub-function)]

[AL. 544_Temperature diagnosis error (safety sub-function)]

- An error occurred in a temperature diagnosis.

[AL. 544.1_Temperature diagnosis error A1 (safety sub-function)]

Cause	Check/action method	Model
1. The ambient temperature exceeded the specified value (60 °C).	Check the ambient temperature, and if the temperature exceeds the specified value, lower the ambient temperature.	[G]
2. The ambient temperature is 0 °C or lower.	Check the ambient temperature, and if the temperature is lower than 0 °C, raise the ambient temperature.	
3. The servo amplifier does not meet the specifications of close mounting.	Check the specifications of close mounting. Refer to "Mounting direction and clearances" in the following manual. □□MR-J5 User's Manual (Hardware)	
4. A cooling fan, heat sink, or opening is clogged.	Clean the cooling fan, heat sink, or openings.	
5. The servo amplifier has malfunctioned.	Replace the servo amplifier.	

[AL. 544.2_Temperature diagnosis error A2 (safety sub-function)]

☞ Page 199 [AL. 544.1_Temperature diagnosis error A1 (safety sub-function)]

[AL. 544.9_Temperature diagnosis error B1 (safety sub-function)]

☞ Page 199 [AL. 544.1_Temperature diagnosis error A1 (safety sub-function)]

[AL. 544.A_Temperature diagnosis error B2 (safety sub-function)]

☞ Page 199 [AL. 544.1_Temperature diagnosis error A1 (safety sub-function)]

[AL. 545_Internal diagnosis error 5 (safety sub-function)]

- There is an error in the result from the functional safety diagnosis.

[AL. 545.2_Internal diagnosis error 5 - Data error A2 (safety sub-function)]

Page 195 [AL. 540.1_Internal diagnosis error 1 - Data error A1 (safety sub-function)]

[AL. 546_ Internal diagnosis error 6 (safety sub-function)]

- There is an error in the result from the functional safety diagnosis.

[AL. 546.1_ Internal diagnosis error 6 - Data error A1 (safety sub-function)]

☞ Page 195 [AL. 540.1_ Internal diagnosis error 1 - Data error A1 (safety sub-function)]

[AL. 546.2_ Internal diagnosis error 6 - Data error A2 (safety sub-function)]

☞ Page 195 [AL. 540.1_ Internal diagnosis error 1 - Data error A1 (safety sub-function)]

[AL. 546.9_ Internal diagnosis error 6 - Data error B1 (safety sub-function)]

☞ Page 195 [AL. 540.1_ Internal diagnosis error 1 - Data error A1 (safety sub-function)]

[AL. 546.A_ Internal diagnosis error 6 - Data error B2 (safety sub-function)]

☞ Page 195 [AL. 540.1_ Internal diagnosis error 1 - Data error A1 (safety sub-function)]

[AL. 547_ Internal diagnosis error 7 (safety sub-function)]

- There is an error in the result from the functional safety diagnosis.

[AL. 547.1_ Internal diagnosis error 7 - Data error A1 (safety sub-function)]

☞ Page 195 [AL. 540.1_ Internal diagnosis error 1 - Data error A1 (safety sub-function)]

[AL. 547.2_ Internal diagnosis error 7 - Data error A2 (safety sub-function)]

☞ Page 195 [AL. 540.1_ Internal diagnosis error 1 - Data error A1 (safety sub-function)]

[AL. 547.9_ Internal diagnosis error 7 - Data error B1 (safety sub-function)]

☞ Page 195 [AL. 540.1_ Internal diagnosis error 1 - Data error A1 (safety sub-function)]

[AL. 547.A_ Internal diagnosis error 7 - Data error B2 (safety sub-function)]

☞ Page 195 [AL. 540.1_ Internal diagnosis error 1 - Data error A1 (safety sub-function)]

[AL. 549_ Internal diagnosis error 8 (safety sub-function)]

- There is an error in the result from the functional safety diagnosis.

[AL. 549.1_ Internal diagnosis error 8 - Data error A1 (safety sub-function)]

☞ Page 195 [AL. 540.1_ Internal diagnosis error 1 - Data error A1 (safety sub-function)]

[AL. 549.9_ Internal diagnosis error 8 - Data error B1 (safety sub-function)]

☞ Page 195 [AL. 540.1_ Internal diagnosis error 1 - Data error A1 (safety sub-function)]

[AL. 54A_Internal diagnosis error 9 (safety sub-function)]

- There is an error in the result from the functional safety diagnosis.

[AL. 54A.1_Internal diagnosis error 9 - Data error A1 (safety sub-function)]

☞ Page 195 [AL. 540.1_Internal diagnosis error 1 - Data error A1 (safety sub-function)]

[AL. 54A.2_Internal diagnosis error 9 - Data error A2 (safety sub-function)]

☞ Page 195 [AL. 540.1_Internal diagnosis error 1 - Data error A1 (safety sub-function)]

[AL. 54A.3_Internal diagnosis error 9 - Data error A3 (safety sub-function)]

☞ Page 195 [AL. 540.1_Internal diagnosis error 1 - Data error A1 (safety sub-function)]

[AL. 54A.9_Internal diagnosis error 9 - Data error B1 (safety sub-function)]

☞ Page 195 [AL. 540.1_Internal diagnosis error 1 - Data error A1 (safety sub-function)]

[AL. 54A.A_Internal diagnosis error 9 - Data error B2 (safety sub-function)]

☞ Page 195 [AL. 540.1_Internal diagnosis error 1 - Data error A1 (safety sub-function)]

[AL. 54A.B_Internal diagnosis error 9 - Data error B3 (safety sub-function)]

☞ Page 195 [AL. 540.1_Internal diagnosis error 1 - Data error A1 (safety sub-function)]

[AL. 54D_ Internal diagnosis error 10 (safety sub-function)]

- There is an error in the result from the functional safety diagnosis.

[AL. 54D.1_ Internal diagnosis error 10 - Data error A1 (safety sub-function)]

☞ Page 195 [AL. 540.1_ Internal diagnosis error 1 - Data error A1 (safety sub-function)]

[AL. 54D.2_ Internal diagnosis error 10 - Data error A2 (safety sub-function)]

☞ Page 195 [AL. 540.1_ Internal diagnosis error 1 - Data error A1 (safety sub-function)]

[AL. 54D.3_ Internal diagnosis error 10 - Data error A3 (safety sub-function)]

☞ Page 195 [AL. 540.1_ Internal diagnosis error 1 - Data error A1 (safety sub-function)]

[AL. 54D.4_ Internal diagnosis error 10 - Data error A4 (safety sub-function)]

☞ Page 195 [AL. 540.1_ Internal diagnosis error 1 - Data error A1 (safety sub-function)]

[AL. 54D.9_ Internal diagnosis error 10 - Data error B1 (safety sub-function)]

☞ Page 195 [AL. 540.1_ Internal diagnosis error 1 - Data error A1 (safety sub-function)]

[AL. 54F_Safety software error (safety sub-function)]

- An error occurred in the safety software.

[AL. 54F.1_Register setting error A1 (safety sub-function)]

Page 195 [AL. 540.1_Internal diagnosis error 1 - Data error A1 (safety sub-function)]

[AL. 550_ Internal diagnosis error 11 (safety sub-function)]

- There is an error in the result from the functional safety diagnosis.

[AL. 550.1_ Internal diagnosis error 11 - Internal signal error A1 (safety sub-function)]

☞ Page 195 [AL. 540.1_ Internal diagnosis error 1 - Data error A1 (safety sub-function)]

[AL. 550.2_ Internal diagnosis error 11 - Internal signal error A2 (safety sub-function)]

☞ Page 211 [AL. 554.1_ SDI1A internal diagnosis error (safety sub-function)]

[AL. 550.3_ Internal diagnosis error 11 - Internal signal error A3 (safety sub-function)]

☞ Page 211 [AL. 554.1_ SDI1A internal diagnosis error (safety sub-function)]

[AL. 550.4_ Internal diagnosis error 11 - Internal signal error A4 (safety sub-function)]

☞ Page 211 [AL. 554.1_ SDI1A internal diagnosis error (safety sub-function)]

[AL. 550.9_ Internal diagnosis error 11 - Internal signal error B1 (safety sub-function)]

☞ Page 211 [AL. 554.1_ SDI1A internal diagnosis error (safety sub-function)]

[AL. 550.A_ Internal diagnosis error 11 - Internal signal error B2 (safety sub-function)]

☞ Page 211 [AL. 554.1_ SDI1A internal diagnosis error (safety sub-function)]

[AL. 550.B_ Internal diagnosis error 11 - Internal signal error B3 (safety sub-function)]

☞ Page 211 [AL. 554.1_ SDI1A internal diagnosis error (safety sub-function)]

[AL. 550.C_ Internal diagnosis error 11 - Internal signal error B4 (safety sub-function)]

☞ Page 211 [AL. 554.1_ SDI1A internal diagnosis error (safety sub-function)]

[AL. 551_Internal diagnosis error 12 (safety sub-function)]

- There is an error in the result from the functional safety diagnosis.

[AL. 551.1_Internal diagnosis error 12 - Internal signal error A1 (safety sub-function)]

☞ Page 207 [AL. 550.1_Internal diagnosis error 11 - Internal signal error A1 (safety sub-function)]

[AL. 551.2_Internal diagnosis error 12 - Internal signal error A2 (safety sub-function)]

☞ Page 207 [AL. 550.1_Internal diagnosis error 11 - Internal signal error A1 (safety sub-function)]

[AL. 551.3_Internal diagnosis error 12 - Internal signal error A3 (safety sub-function)]

☞ Page 207 [AL. 550.1_Internal diagnosis error 11 - Internal signal error A1 (safety sub-function)]

[AL. 551.4_Internal diagnosis error 12 - Internal signal error A4 (safety sub-function)]

☞ Page 207 [AL. 550.1_Internal diagnosis error 11 - Internal signal error A1 (safety sub-function)]

[AL. 551.9_Internal diagnosis error 12 - Internal signal error B1 (safety sub-function)]

☞ Page 207 [AL. 550.1_Internal diagnosis error 11 - Internal signal error A1 (safety sub-function)]

[AL. 551.A_Internal diagnosis error 12 - Internal signal error B2 (safety sub-function)]

☞ Page 207 [AL. 550.1_Internal diagnosis error 11 - Internal signal error A1 (safety sub-function)]

[AL. 551.B_Internal diagnosis error 12 - Internal signal error B3 (safety sub-function)]

☞ Page 207 [AL. 550.1_Internal diagnosis error 11 - Internal signal error A1 (safety sub-function)]

[AL. 551.C_Internal diagnosis error 12 - Internal signal error B4 (safety sub-function)]

☞ Page 207 [AL. 550.1_Internal diagnosis error 11 - Internal signal error A1 (safety sub-function)]

[AL. 552_ Internal diagnosis error 13 (safety sub-function)]

- There is an error in the result from the functional safety diagnosis.

[AL. 552.1_ Internal diagnosis error 13 - Internal signal error A1 (safety sub-function)]

☞ Page 207 [AL. 550.1_ Internal diagnosis error 11 - Internal signal error A1 (safety sub-function)]



[AL. 552.9_ Internal diagnosis error 13 - Internal signal error B1 (safety sub-function)]

☞ Page 207 [AL. 550.1_ Internal diagnosis error 11 - Internal signal error A1 (safety sub-function)]

[AL. 553_Input device diagnosis error (safety sub-function)]

- There is a problem with the input device.

[AL. 553.1_SDI1A test pulse diagnosis error (safety sub-function)]

Cause	Check/action method	Model
1. A signal of an input device has not been input correctly.	Check if the input device cable is wired correctly.	[G]
2. The functional safety parameter in the input device setting has been set incorrectly.	Check if the functional safety parameter has been set correctly.	
3. The test pulse time has been set incorrectly.	Review the setting value of [Pr. PSD26 Input device - Test pulse off time].	
4. The servo amplifier has malfunctioned.	Replace the servo amplifier.	
5. There is a problem with the surrounding environment.	Check the noise, ambient temperature, and other conditions, and implement appropriate countermeasures for the cause. If there is noise, take countermeasures to reduce the noise. Refer to "Noise reduction techniques" in the following manuals.  MR-J5 User's Manual (Hardware)  MR-J5D User's Manual (Hardware)	

[AL. 553.2_SDI2A test pulse diagnosis error (safety sub-function)]

 Page 210 [AL. 553.1_SDI1A test pulse diagnosis error (safety sub-function)]

[AL. 553.3_SDI3A test pulse diagnosis error (safety sub-function)]

 Page 210 [AL. 553.1_SDI1A test pulse diagnosis error (safety sub-function)]

[AL. 553.9_SDI1B test pulse diagnosis error (safety sub-function)]

 Page 210 [AL. 553.1_SDI1A test pulse diagnosis error (safety sub-function)]

[AL. 553.A_SDI2B test pulse diagnosis error (safety sub-function)]

 Page 210 [AL. 553.1_SDI1A test pulse diagnosis error (safety sub-function)]

[AL. 553.B_SDI3B test pulse diagnosis error (safety sub-function)]

 Page 210 [AL. 553.1_SDI1A test pulse diagnosis error (safety sub-function)]

[AL. 554_Input device internal diagnosis error (safety sub-function)]

- There is an error in the input device.

[AL. 554.1_SDI1A internal diagnosis error (safety sub-function)]

Cause	Check/action method	Model
1. The servo amplifier has malfunctioned.	Replace the servo amplifier.	[G]
2. There is a problem with the surrounding environment.	Check the noise, ambient temperature, and other conditions, and implement appropriate countermeasures for the cause. If there is noise, take countermeasures to reduce the noise. Refer to "Noise reduction techniques" in the following manuals. <ul style="list-style-type: none"> 📖 MR-J5 User's Manual (Hardware) 📖 MR-J5D User's Manual (Hardware) 	

[AL. 554.2_SDI2A internal diagnosis error (safety sub-function)]

📖 Page 211 [AL. 554.1_SDI1A internal diagnosis error (safety sub-function)]

[AL. 554.3_SDI3A internal diagnosis error (safety sub-function)]

📖 Page 211 [AL. 554.1_SDI1A internal diagnosis error (safety sub-function)]

[AL. 554.9_SDI1B internal diagnosis error (safety sub-function)]

📖 Page 211 [AL. 554.1_SDI1A internal diagnosis error (safety sub-function)]

[AL. 554.A_SDI2B internal diagnosis error (safety sub-function)]

📖 Page 211 [AL. 554.1_SDI1A internal diagnosis error (safety sub-function)]



[AL. 554.B_SDI3B internal diagnosis error (safety sub-function)]

📖 Page 211 [AL. 554.1_SDI1A internal diagnosis error (safety sub-function)]

[AL. 555_ Output device diagnosis error 1 (safety sub-function)]

- There is an error in the output device.

[AL. 555.1_SDO1A output mismatch error (safety sub-function)]

Cause	Check/action method	Model
1. A signal of an output device has been output incorrectly, or the load of the output device has exceeded the specified range.	Check if the output device cable is wired correctly, or check if the load of the output device is within specifications.	[G]
2. The output device current is too large.	Check if the current value is within the specified value. Lower the output current if the specified value is exceeded.	
3. The servo amplifier has malfunctioned.	Replace the servo amplifier.	
4. There is a problem with the surrounding environment.	Check the noise, ambient temperature, and other conditions, and implement appropriate countermeasures for the cause. If there is noise, take countermeasures to reduce the noise. Refer to "Noise reduction techniques" in the following manuals.  MR-J5 User's Manual (Hardware)  MR-J5D User's Manual (Hardware)	

[AL. 555.2_SDO2A output mismatch error (safety sub-function)]

 Page 212 [AL. 555.1_SDO1A output mismatch error (safety sub-function)]

[AL. 555.3_SDO3A output mismatch error (safety sub-function)]

 Page 212 [AL. 555.1_SDO1A output mismatch error (safety sub-function)]

[AL. 555.9_SDO1B output mismatch error (safety sub-function)]

 Page 212 [AL. 555.1_SDO1A output mismatch error (safety sub-function)]

[AL. 555.A_SDO2B output mismatch error (safety sub-function)]

 Page 212 [AL. 555.1_SDO1A output mismatch error (safety sub-function)]

[AL. 555.B_SDO3B output mismatch error (safety sub-function)]

 Page 212 [AL. 555.1_SDO1A output mismatch error (safety sub-function)]

[AL. 556_Output device diagnosis error 2 (safety sub-function)]

- There is an error in the output device.

[AL. 556.1_SDO1A test pulse diagnosis error (safety sub-function)]

Cause	Check/action method	Model
1. [Pr. PSD30 Output device - Test pulse off time] is set incorrectly.	Review the setting value of [Pr. PSD30].	[G]
2. Take actions in accordance with the items shown below.  Page 212 [AL. 555.1_SDO1A output mismatch error (safety sub-function)]		

[AL. 556.2_SDO2A test pulse diagnosis error (safety sub-function)]

 Page 213 [AL. 556.1_SDO1A test pulse diagnosis error (safety sub-function)]

[AL. 556.3_SDO3A test pulse diagnosis error (safety sub-function)]

 Page 213 [AL. 556.1_SDO1A test pulse diagnosis error (safety sub-function)]

[AL. 556.9_SDO1B test pulse diagnosis error (safety sub-function)]

 Page 213 [AL. 556.1_SDO1A test pulse diagnosis error (safety sub-function)]

[AL. 556.A_SDO2B test pulse diagnosis error (safety sub-function)]

 Page 213 [AL. 556.1_SDO1A test pulse diagnosis error (safety sub-function)]

[AL. 556.B_SDO3B test pulse diagnosis error (safety sub-function)]

 Page 213 [AL. 556.1_SDO1A test pulse diagnosis error (safety sub-function)]

[AL. 557_Input device mismatch detection (safety sub-function)]

- An input device mismatch was detected.

[AL. 557.1_SDI1 input mismatch error A (safety sub-function)]

Cause	Check/action method	Model
1. The input signals of SDI1A and SDI1B remained mismatched for longer than the specified time ([Pr. PSD18 Permissible time for mismatches DI1]).	Review the wiring of SDI1A and SDI1B. For the wiring, refer to "USING STO FUNCTION" and "USING FUNCTIONAL SAFETY" in the following manuals. <input type="checkbox"/> MR-J5 User's Manual (Hardware) <input type="checkbox"/> MR-J5D User's Manual (Hardware) Set [Pr. PSD18] to a value longer than the mismatched time of SDI1.	[G]
2. The servo amplifier has malfunctioned.	Replace the servo amplifier.	
3. There is a problem with the surrounding environment.	Check the noise, ambient temperature, and other conditions, and implement appropriate countermeasures for the cause. If there is noise, take countermeasures to reduce the noise. Refer to "Noise reduction techniques" in the following manuals. <input type="checkbox"/> MR-J5 User's Manual (Hardware) <input type="checkbox"/> MR-J5D User's Manual (Hardware)	

[AL. 557.2_SDI2 input mismatch error A (safety sub-function)]

Cause	Check/action method	Model
1. The input signals of SDI2A and SDI2B remained mismatched for longer than the specified time ([Pr. PSD19 Permissible time for mismatches DI2]).	Review the wiring of SDI2A and SDI2B. For the wiring, refer to "USING STO FUNCTION" and "USING FUNCTIONAL SAFETY" in the following manuals. <input type="checkbox"/> MR-J5 User's Manual (Hardware) <input type="checkbox"/> MR-J5D User's Manual (Hardware) Set [Pr. PSD19] to a value longer than the mismatched time of SDI2.	[G]
2. The servo amplifier has malfunctioned.	Replace the servo amplifier.	
3. There is a problem with the surrounding environment.	Check the noise, ambient temperature, and other conditions, and implement appropriate countermeasures for the cause. If there is noise, take countermeasures to reduce the noise. Refer to "Noise reduction techniques" in the following manuals. <input type="checkbox"/> MR-J5 User's Manual (Hardware) <input type="checkbox"/> MR-J5D User's Manual (Hardware)	

[AL. 557.3_SDI3 input mismatch error A (safety sub-function)]

Cause	Check/action method	Model
1. The input signals of SDI3A and SDI3B remained mismatched for longer than the specified time ([Pr. PSD20 Permissible time for mismatches DI3]).	Review the wiring of SDI3A and SDI3B. For the wiring, refer to "USING STO FUNCTION" and "USING FUNCTIONAL SAFETY" in the following manuals. <input type="checkbox"/> MR-J5 User's Manual (Hardware) <input type="checkbox"/> MR-J5D User's Manual (Hardware) Set [Pr. PSD20] to a value longer than the mismatched time of SDI3.	[G]
2. The servo amplifier has malfunctioned.	Replace the servo amplifier.	
3. There is a problem with the surrounding environment.	Check the noise, ambient temperature, and other conditions, and implement appropriate countermeasures for the cause. If there is noise, take countermeasures to reduce the noise. Refer to "Noise reduction techniques" in the following manuals. <input type="checkbox"/> MR-J5 User's Manual (Hardware) <input type="checkbox"/> MR-J5D User's Manual (Hardware)	

[AL. 557.9_SD11 input mismatch error B (safety sub-function)]

☞ Page 214 [AL. 557.1_SD11 input mismatch error A (safety sub-function)]

[AL. 557.A_SD12 input mismatch error B (safety sub-function)]

☞ Page 214 [AL. 557.2_SD12 input mismatch error A (safety sub-function)]

[AL. 557.B_SD13 input mismatch error B (safety sub-function)]

☞ Page 214 [AL. 557.3_SD13 input mismatch error A (safety sub-function)]

[AL. 560_Stop error (safety sub-function)]

- The safety sub-function detected an error of the stop position.

[AL. 560.1_SOS feedback speed exceeded A]

Cause	Check/action method	Model
<p>1. The state where the absolute value of the servo motor speed exceeds the setting value of [Pr. PSA04 Safety sub-function - Stop speed] continued for the time set in [Pr. PSA15 Safety sub-function - Speed detection delay time] or longer during operation of the SOS function.</p>	<p>Review the parameter or the operation pattern. If the servo motor overshoots as it stops, take actions such as adjusting the gains or setting a larger value in [Pr. PSA15]. Refer to "SS2/SOS function" in the following manual. MR-J5 User's Manual (Function)</p>	[G]
<p>2. The encoder has malfunctioned.</p>	<p>Replace the servo motor.</p>	
<p>3. The servo amplifier has malfunctioned.</p>	<p>Replace the servo amplifier.</p>	
<p>4. There is a problem with the surrounding environment.</p>	<p>Check the noise, ambient temperature, and other conditions, and implement appropriate countermeasures for the cause. If there is noise, take countermeasures to reduce the noise. Refer to "Noise reduction techniques" in the following manuals. MR-J5 User's Manual (Hardware) MR-J5D User's Manual (Hardware)</p>	

[AL. 560.2_SOS command speed exceeded A]

Cause	Check/action method	Model
<p>1. The state where the absolute value of the speed command exceeds the setting value of [Pr. PSA04 Safety sub-function - Stop speed] continued for the time set in [Pr. PSA15 Safety sub-function - Speed detection delay time] or longer during operation of the SOS function.</p>	<p>Review the parameter or the operation pattern. Set [Pr. PSA03 SS1/SS2 deceleration monitor time] to a longer time than the deceleration time. Check if the speed command has been input after SOS was activated. Refer to "SS2/SOS function" in the following manual. MR-J5 User's Manual (Function)</p>	[G]
<p>2. Take actions according to the instructions of 2. to 4. in the following item.</p> <p> Page 216 [AL. 560.1_SOS feedback speed exceeded A]</p>		

[AL. 560.3_SOS feedback position exceeded A]

Cause	Check/action method	Model
<p>1. The feedback position changed by the value equal to or more than the setting value of [Pr. PSA05 SOS permissible travel distance], and the position remained out of the permissible range for the time set in [Pr. PSA17 Safety sub-function - Position detection delay time] or longer during operation of the SOS function.</p>	<p>Review the parameter or the operation pattern. If the servo motor overshoots as it stops, take actions such as adjusting the gains or setting a larger value in [Pr. PSA17]. Refer to "SS2/SOS function" in the following manual. MR-J5 User's Manual (Function)</p>	[G]
<p>2. Take actions according to the instructions of 2. to 4. in the following item.</p> <p> Page 216 [AL. 560.1_SOS feedback speed exceeded A]</p>		

[AL. 560.9_SOS feedback speed exceeded B]

☞ Page 216 [AL. 560.1_SOS feedback speed exceeded A]

[AL. 560.A_SOS command speed exceeded B]

☞ Page 216 [AL. 560.2_SOS command speed exceeded A]

[AL. 560.B_SOS feedback position exceeded B]

☞ Page 216 [AL. 560.3_SOS feedback position exceeded A]

[AL. 561_Safety speed monitor error 1 (safety sub-function)]

- The safety sub-function detected an error of the servo motor speed.

[AL. 561.1_SLS1 feedback speed exceeded A]

Cause	Check/action method	Model
1. The state where the absolute value of the servo motor speed exceeds the setting value of [Pr. PSA11 SLS speed 1] continued for the time set in [Pr. PSA15 Safety sub-function - Speed detection delay time] or longer during operation of the SLS function.	Review the parameter or the operation pattern. Take actions such as setting the speed command to a value equal to or lower than the value of [Pr. PSA11] or setting the time required for deceleration in [Pr. PSA07 SLS deceleration monitor time 1]. Refer to "SLS function" in the following manual. MR-J5 User's Manual (Function)	[G]
2. The settings of the electronic gear are incorrect.	Check the setting value of the electronic gear. Refer to "Electronic gear function" in the following manual. MR-J5 User's Manual (Function)	
3. The servo system is unstable and oscillating.	Adjust the servo gain or reduce the load.	
4. The velocity waveform overshoot.	Increase the acceleration/deceleration time constants.	
5. The connection destination of the encoder cable is incorrect.	Check the connection destination of the encoder.	
6. The encoder has malfunctioned.	Replace the servo motor.	

[AL. 561.2_SLS1 command speed exceeded A]

Cause	Check/action method	Model
1. The state where the absolute value of the speed command exceeds the setting value of [Pr. PSA11 SLS speed 1] continued for the time set in [Pr. PSA15 Safety sub-function - Speed detection delay time] or longer during operation of the SLS function.	Review the parameter or the operation pattern. Take actions such as setting the speed command to a value equal to or lower than the value of [Pr. PSA11] or setting [Pr. PSA15] to a longer value. If in torque control, set the speed limit to a value equal to or lower than the value of [Pr. PSA11]. Refer to "SLS function" in the following manual. MR-J5 User's Manual (Function)	[G]
2. Take actions according to the instructions of 5. to 6. in the following item. Page 218 [AL. 561.1_SLS1 feedback speed exceeded A]		

[AL. 561.3_SLS2 feedback speed exceeded A]

Cause	Check/action method	Model
1. The state where the absolute value of the servo motor speed exceeds the setting value of [Pr. PSA12 SLS speed 2] continued for the time set in [Pr. PSA15 Safety sub-function - Speed detection delay time] or longer during operation of the SLS function.	Review the parameter or the operation pattern. Take actions such as setting the speed command to a value equal to or lower than the value of [Pr. PSA12] or setting the time required for deceleration in [Pr. PSA07 SLS deceleration monitor time 1]. Refer to "SLS function" in the following manual. MR-J5 User's Manual (Function)	[G]
2. Take actions according to the instructions of 2. to 6. in the following item. Page 218 [AL. 561.1_SLS1 feedback speed exceeded A]		

[AL. 561.4_SLS2 command speed exceeded A]

Cause	Check/action method	Model
<p>1. The state where the absolute value of the speed command exceeds the setting value of [Pr. PSA12 SLS speed 2] continued for the time set in [Pr. PSA15 Safety sub-function - Speed detection delay time] or longer during operation of the SLS function.</p>	<p>Review the parameter or the operation pattern. Take actions such as setting the speed command to a value equal to or lower than the value of [Pr. PSA12] or setting [Pr. PSA15] to a longer value. If in torque control, set the speed limit to a value equal to or lower than the value of [Pr. PSA12]. Refer to "SLS function" in the following manual. ◀MR-J5 User's Manual (Function)</p>	[G]
<p>2. Take actions according to the instructions of 5. to 6. in the following item.</p> <p>☞ Page 218 [AL. 561.1_SLS1 feedback speed exceeded A]</p>		

[AL. 561.9_SLS1 feedback speed exceeded B]

☞ Page 218 [AL. 561.1_SLS1 feedback speed exceeded A]

[AL. 561.A_SLS1 command speed exceeded B]

☞ Page 218 [AL. 561.2_SLS1 command speed exceeded A]

[AL. 561.B_SLS2 feedback speed exceeded B]

☞ Page 218 [AL. 561.3_SLS2 feedback speed exceeded A]

[AL. 561.C_SLS2 command speed exceeded B]

☞ Page 219 [AL. 561.4_SLS2 command speed exceeded A]

[AL. 562_Safety speed monitor error 2 (safety sub-function)]

- The safety sub-function detected an error of the servo motor speed.

[AL. 562.1_SLS3 feedback speed exceeded A]

Cause	Check/action method	Model
<p>1. The state where the absolute value of the servo motor speed exceeds the setting value of [Pr. PSA13 SLS speed 3] continued for the time set in [Pr. PSA15 Safety sub-function - Speed detection delay time] or longer during operation of the SLS function.</p>	<p>Review the parameter or the operation pattern. Take actions such as setting the speed command to a value equal to or lower than the value of [Pr. PSA13] or setting the time required for deceleration in [Pr. PSA07 SLS deceleration monitor time 1]. Refer to "SLS function" in the following manual. MR-J5 User's Manual (Function)</p>	[G]
<p>2. Take actions according to the instructions of 2. to 6. in the following item.</p> <p> Page 218 [AL. 561.1_SLS1 feedback speed exceeded A]</p>		

[AL. 562.2_SLS3 command speed exceeded A]

Cause	Check/action method	Model
<p>1. The state where the absolute value of the speed command exceeds the setting value of [Pr. PSA13 SLS speed 3] continued for the time set in [Pr. PSA15 Safety sub-function - Speed detection delay time] or longer during operation of the SLS function.</p>	<p>Review the parameter or the operation pattern. Take actions such as setting the speed command to a value equal to or lower than the value of [Pr. PSA13] or setting [Pr. PSA15] to a longer value. If in torque control, set the speed limit to a value equal to or lower than the value of [Pr. PSA13]. Refer to "SLS function" in the following manual. MR-J5 User's Manual (Function)</p>	[G]
<p>2. Take actions according to the instructions of 5. to 6. in the following item.</p> <p> Page 218 [AL. 561.1_SLS1 feedback speed exceeded A]</p>		

[AL. 562.3_SLS4 feedback speed exceeded A]

Cause	Check/action method	Model
<p>1. The state where the absolute value of the servo motor speed exceeds the setting value of [Pr. PSA14 SLS speed 4] continued for the time set in [Pr. PSA15 Safety sub-function - Speed detection delay time] or longer during operation of the SLS function.</p>	<p>Review the parameter or the operation pattern. Take actions such as setting the speed command to a value equal to or lower than the value of [Pr. PSA14] or setting the time required for deceleration in [Pr. PSA07 SLS deceleration monitor time 1]. Refer to "SLS function" in the following manual. MR-J5 User's Manual (Function)</p>	[G]
<p>2. Take actions according to the instructions of 2. to 6. in the following item.</p> <p> Page 218 [AL. 561.1_SLS1 feedback speed exceeded A]</p>		

[AL. 562.4_SLS4 command speed exceeded A]

Cause	Check/action method	Model
<p>1. The state where the absolute value of the speed command exceeds the setting value of [Pr. PSA14 SLS speed 4] continued for the time set in [Pr. PSA15 Safety sub-function - Speed detection delay time] or longer during operation of the SLS function.</p>	<p>Review the parameter or the operation pattern. Take actions such as setting the speed command to a value equal to or lower than the value of [Pr. PSA14] or setting [Pr. PSA15] to a longer value. If in torque control, set the speed limit to a value equal to or lower than the value of [Pr. PSA14]. Refer to "SLS function" in the following manual. MR-J5 User's Manual (Function)</p>	[G]
<p>2. Take actions according to the instructions of 5. to 6. in the following item.</p> <p> Page 218 [AL. 561.1_SLS1 feedback speed exceeded A]</p>		

[AL. 562.9_SLS3 feedback speed exceeded B]

☞ Page 220 [AL. 562.1_SLS3 feedback speed exceeded A]

[AL. 562.A_SLS3 command speed exceeded B]

☞ Page 220 [AL. 562.2_SLS3 command speed exceeded A]

[AL. 562.B_SLS4 feedback speed exceeded B]

☞ Page 220 [AL. 562.3_SLS4 feedback speed exceeded A]

[AL. 562.C_SLS4 command speed exceeded B]

☞ Page 220 [AL. 562.4_SLS4 command speed exceeded A]

[AL. 563_Deceleration monitor error (safety sub-function)]

- There is a problem with deceleration operation in the safety sub-function.

[AL. 563.1_SS1 feedback speed exceeded A]

Cause	Check/action method	Model
1. The servo motor exceeded the observation speed specified by [Pr. PSA24 SS1/SS2 deceleration monitor time constant] from the observation speed when the SS1 command was turned off during operation of the SS1 function.	Review the parameter or the operation pattern. Take actions such as setting a larger value in [Pr. PSA26 SS1/SS2 deceleration monitor delay time] or adjusting the servo gains. Refer to "SS1 function" in the following manual. MR-J5 User's Manual (Function)	[G]
2. The connection destination of the encoder cable is incorrect.	Check the connection destination of the encoder.	
3. There is a problem with the servo motor or the servo motor power cable.	Replace the servo motor or the servo motor power cable.	
4. The encoder has malfunctioned.	Replace the servo motor.	
5. The servo amplifier has malfunctioned.	Replace the servo amplifier.	
6. There is a problem with the surrounding environment.	Check the noise, ambient temperature, and other conditions, and implement appropriate countermeasures for the cause. If there is noise, take countermeasures to reduce the noise. Refer to "Noise reduction techniques" in the following manuals. MR-J5 User's Manual (Hardware) MR-J5D User's Manual (Hardware)	

[AL. 563.2_SS1 command speed exceeded A]

Cause	Check/action method	Model
1. A speed command was input exceeding the observation speed specified by [Pr. PSA24 SS1/SS2 deceleration monitor time constant] from the observation speed when the SS1 command was turned off during operation of the SS1 function.	Review the parameter or the operation pattern. Take actions such as performing settings so that the time set in [Pr. PC24 Deceleration time constant at forced stop] becomes shorter than in [Pr. PSA24]. Refer to "SS1 function" in the following manual. MR-J5 User's Manual (Function)	[G]
2. Take actions according to the instructions of 2. to 6. in the following item.		
Page 222 [AL. 563.1_SS1 feedback speed exceeded A]		

[AL. 563.3_SS2 feedback speed exceeded A]

Cause	Check/action method	Model
1. The servo motor exceeded the observation speed specified by [Pr. PSA24 SS1/SS2 deceleration monitor time constant] from the observation speed when the SS2 command was turned off during operation of the SS2 function.	Review the parameter or the operation pattern. Take actions such as performing settings so that the deceleration command from the controller does not exceed the deceleration monitor time constant, setting a larger value in [Pr. PSA26 SS1/SS2 deceleration monitor delay time], or adjusting the servo gains. Refer to "SS2/SOS function" in the following manual. MR-J5 User's Manual (Function)	[G]
2. Take actions according to the instructions of 2. to 6. in the following item.		
Page 222 [AL. 563.1_SS1 feedback speed exceeded A]		

[AL. 563.4_SS2 command speed exceeded A]

Cause	Check/action method	Model
<p>1. A speed command was input exceeding the observation speed specified by [Pr. PSA24 SS1/SS2 deceleration monitor time constant] from the observation speed when the SS2 command was turned off during operation of the SS2 function.</p>	<p>Review the parameter or the operation pattern. Take actions such as performing settings so that the deceleration command from the controller does not exceed the deceleration monitor time constant. Refer to "SS2/SOS function" in the following manual. <input type="checkbox"/> MR-J5 User's Manual (Function)</p>	[G]
<p>2. Take actions according to the instructions of 2. to 6. in the following item. <input type="checkbox"/> Page 222 [AL. 563.1_SS1 feedback speed exceeded A]</p>		

[AL. 563.9_SS1 feedback speed exceeded B]

Page 222 [AL. 563.1_SS1 feedback speed exceeded A]

[AL. 563.A_SS1 command speed exceeded B]

Page 222 [AL. 563.2_SS1 command speed exceeded A]

[AL. 563.B_SS2 feedback speed exceeded B]

Page 222 [AL. 563.3_SS2 feedback speed exceeded A]



[AL. 563.C_SS2 command speed exceeded B]

Page 223 [AL. 563.4_SS2 command speed exceeded A]

[AL. 564_Increment monitor error (safety sub-function)]

- There is a problem with the travel distance in the safety sub-function.

[AL. 564.1_SLI feedback position exceeded A]

Cause	Check/action method	Model
1. The feedback position moved by a distance exceeding the permissible travel distance set in [Pr. PSB02 SLI permissible travel distance - Positive direction 1] or [Pr. PSB06 SLI permissible travel distance - Negative direction 1] after operation of the SLI function.	Review the parameter or the operation pattern. Check if the SLI command was input before the motor stopped. Refer to "SLI function" in the following manual.  MR-J5 User's Manual (Function)	[G]
2. Take actions according to the instructions of 2. to 6. in the following item.  Page 222 [AL. 563.1_SS1 feedback speed exceeded A]		

[AL. 564.9_SLI feedback position exceeded B]

 Page 224 [AL. 564.1_SLI feedback position exceeded A]

[AL. 565_Direction monitor error (safety sub-function)]

- There is a problem with the servo motor travel distance direction in the safety sub-function.

[AL. 565.1_SDIP feedback speed exceeded A]

Cause	Check/action method	Model
1. The servo motor moved in the address increasing direction while the SDI function was operating.	Review the parameter or the operation pattern. Check if a command in the address increasing direction was input. Refer to "SLI function" in the following manual. MR-J5 User's Manual (Function)	[G]
2. The velocity waveform overshoot.	Check if the velocity waveform has overshoot because of the short acceleration/ deceleration time constant. If the velocity waveform has overshoot, increase the acceleration/deceleration time constant.	
3. The connection of the servo motor is incorrect.	Check the U/V/W wiring. Refer to "Example power circuit connections" in the following manuals. MR-J5 User's Manual (Hardware) MR-J5D User's Manual (Hardware) Refer to "Turning on servo amplifier for the first time" in the User's Manual (Introduction).	
4. Take actions according to the instructions of 2. to 6. in the following item. Page 222 [AL. 563.1_SS1 feedback speed exceeded A]		

[AL. 565.2_SDIP command speed exceeded A]

Cause	Check/action method	Model
1. A speed command was input in the address increasing direction while the SDI function was operating.	Review the parameter or the operation pattern. Check if a command in the address increasing direction was input. Refer to "SLI function" in the following manual. MR-J5 User's Manual (Function)	[G]
2. Take actions according to the instructions of 2. to 6. in the following item. Page 222 [AL. 563.1_SS1 feedback speed exceeded A]		

[AL. 565.3_SDIN feedback speed exceeded A]

Cause	Check/action method	Model
1. The servo motor moved in the address decreasing direction while the SDI function was operating.	Review the parameter or the operation pattern. Check if a command in the address increasing direction was input. Refer to "SLI function" in the following manual. MR-J5 User's Manual (Function)	[G]
2. The velocity waveform overshoot.	Check if the velocity waveform has overshoot because of the short acceleration/ deceleration time constant. If the velocity waveform has overshoot, increase the acceleration/deceleration time constant.	
3. The connection of the servo motor is incorrect.	Check the U/V/W wiring. Refer to "Example power circuit connections" in the following manuals. MR-J5 User's Manual (Hardware) MR-J5D User's Manual (Hardware) Refer to "Turning on servo amplifier for the first time" in the User's Manual (Introduction).	
4. Take actions according to the instructions of 2. to 6. in the following item. Page 222 [AL. 563.1_SS1 feedback speed exceeded A]		

[AL. 565.4_SDIN command speed exceeded A]

Cause	Check/action method	Model
1. A speed command was input in the address decreasing direction while the SDI function was operating.	Review the parameter or the operation pattern. Check if a command in the address increasing direction was input. Refer to "SLI function" in the following manual. ↳ MR-J5 User's Manual (Function)	[G]
2. Take actions according to the instructions of 2. to 6. in the following item. ↳ Page 222 [AL. 563.1_SS1 feedback speed exceeded A]		

[AL. 565.9_SDIP feedback speed exceeded B]

↳ Page 225 [AL. 565.1_SDIP feedback speed exceeded A]

[AL. 565.A_SDIP command speed exceeded B]

↳ Page 225 [AL. 565.2_SDIP command speed exceeded A]

[AL. 565.B_SDIN feedback speed exceeded B]

↳ Page 225 [AL. 565.3_SDIN feedback speed exceeded A]

[AL. 565.C_SDIN command speed exceeded B]

↳ Page 226 [AL. 565.4_SDIN command speed exceeded A]

[AL. 568_Torque monitor error 1 (safety sub-function)]

- There is a problem with the torque in the safety sub-function.

[AL. 568.1_SLT1 feedback torque exceeded error A]

Cause	Check/action method	Model
1. The torque feedback exceeded the torque set in [Pr. PSB10 SLT torque upper limit value 1] and [Pr. PSB14 SLT torque lower limit value 1] after operation of the SLT function.	Review the parameter or the operation pattern. Check if the threshold for the torque monitor is too small or if the servo motor collides with the machine. Refer to "SLT function" in the following manual. □MR-J5 User's Manual (Function)	[G]
2. Take actions according to the instructions of 2. to 6. in the following item.  Page 222 [AL. 563.1_SS1 feedback speed exceeded A]		

[AL. 568.2_SLT1 command torque exceeded error A]

Cause	Check/action method	Model
1. The torque command exceeded the torque set in [Pr. PSB10 SLT torque upper limit value 1] and [Pr. PSB14 SLT torque lower limit value 1] after operation of the SLT function.	Review the parameter or the operation pattern. Check if the threshold for the SLT torque is too small or if the servo motor collides with the machine. Refer to "SLT function" in the following manual. □MR-J5 User's Manual (Function)	[G]
2. Take actions according to the instructions of 2. to 6. in the following item.  Page 222 [AL. 563.1_SS1 feedback speed exceeded A]		

[AL. 568.3_SLT2 feedback torque exceeded error A]

Cause	Check/action method	Model
1. The torque feedback exceeded the torque set in [Pr. PSB11 SLT torque upper limit value 2] and [Pr. PSB15 SLT torque lower limit value 2] after operation of the SLT function.	Review the parameter or the operation pattern. Check if the threshold for the torque monitor is too small or if the servo motor collides with the machine. Refer to "SLT function" in the following manual. □MR-J5 User's Manual (Function)	[G]
2. Take actions according to the instructions of 2. to 6. in the following item.  Page 222 [AL. 563.1_SS1 feedback speed exceeded A]		

[AL. 568.4_SLT2 command torque exceeded error A]

Cause	Check/action method	Model
1. The torque command exceeded the torque set in [Pr. PSB11 SLT torque upper limit value 2] and [Pr. PSB15 SLT torque lower limit value 2] after operation of the SLT function.	Review the parameter or the operation pattern. Check if the threshold for the SLT torque is too small or if the servo motor collides with the machine. Refer to "SLT function" in the following manual. □MR-J5 User's Manual (Function)	[G]
2. Take actions according to the instructions of 2. to 6. in the following item.  Page 222 [AL. 563.1_SS1 feedback speed exceeded A]		

[AL. 568.9_SLT1 feedback torque exceeded error B]

☞ Page 227 [AL. 568.1_SLT1 feedback torque exceeded error A]

[AL. 568.A_SLT1 command torque exceeded error B]

☞ Page 227 [AL. 568.2_SLT1 command torque exceeded error A]

[AL. 568.B_SLT2 feedback torque exceeded error B]

☞ Page 227 [AL. 568.3_SLT2 feedback torque exceeded error A]

[AL. 568.C_SLT2 command torque exceeded error B]

☞ Page 227 [AL. 568.4_SLT2 command torque exceeded error A]

[AL. 569_Torque monitor error 2 (safety sub-function)]

- There is a problem with the torque in the safety sub-function.

[AL. 569.1_SLT3 feedback torque exceeded error A]

Cause	Check/action method	Model
1. The torque feedback exceeded the torque set in [Pr. PSB12 SLT torque upper limit value 3] and [Pr. PSB16 SLT torque lower limit value 3] after operation of the SLT function.	Review the parameter or the operation pattern. Check if the threshold for the torque monitor is too small or if the servo motor collides with the machine. Refer to "SLT function" in the following manual. □MR-J5 User's Manual (Function)	[G]
2. Take actions according to the instructions of 2. to 6. in the following item.  Page 222 [AL. 563.1_SS1 feedback speed exceeded A]		

[AL. 569.2_SLT3 command torque exceeded error A]

Cause	Check/action method	Model
1. The torque command exceeded the torque set in [Pr. PSB12 SLT torque upper limit value 3] and [Pr. PSB16 SLT torque lower limit value 3] after operation of the SLT function.	Review the parameter or the operation pattern. Check if the threshold for the SLT torque is too small or if the servo motor collides with the machine. Refer to "SLT function" in the following manual. □MR-J5 User's Manual (Function)	[G]
2. Take actions according to the instructions of 2. to 6. in the following item.  Page 222 [AL. 563.1_SS1 feedback speed exceeded A]		

[AL. 569.3_SLT4 feedback torque exceeded error A]

Cause	Check/action method	Model
1. The torque feedback exceeded the torque set in [Pr. PSB13 SLT torque upper limit value 4] and [Pr. PSB17 SLT torque lower limit value 4] after operation of the SLT function.	Review the parameter or the operation pattern. Check if the threshold for the torque monitor is too small or if the servo motor collides with the machine. Refer to "SLT function" in the following manual. □MR-J5 User's Manual (Function)	[G]
2. Take actions according to the instructions of 2. to 6. in the following item.  Page 222 [AL. 563.1_SS1 feedback speed exceeded A]		

[AL. 569.4_SLT4 command torque exceeded error A]

Cause	Check/action method	Model
1. The torque command exceeded the torque set in [Pr. PSB13 SLT torque upper limit value 4] and [Pr. PSB17 SLT torque lower limit value 4] after operation of the SLT function.	Review the parameter or the operation pattern. Check if the threshold for the SLT torque is too small or if the servo motor collides with the machine. Refer to "SLT function" in the following manual. □MR-J5 User's Manual (Function)	[G]
2. Take actions according to the instructions of 2. to 6. in the following item.  Page 222 [AL. 563.1_SS1 feedback speed exceeded A]		

[AL. 569.9_SLT3 feedback torque exceeded error B]

☞ Page 229 [AL. 569.1_SLT3 feedback torque exceeded error A]

[AL. 569.A_SLT3 command torque exceeded error B]

☞ Page 229 [AL. 569.2_SLT3 command torque exceeded error A]

[AL. 569.B_SLT4 feedback torque exceeded error B]

☞ Page 229 [AL. 569.3_SLT4 feedback torque exceeded error A]

[AL. 569.C_SLT4 command torque exceeded error B]

☞ Page 229 [AL. 569.4_SLT4 command torque exceeded error A]

[AL. 580_Safety communication setting error (safety sub-function)]

- There is a problem with the safety communication settings.

[AL. 580.3_Safety verification code mismatch A]

Cause	Check/action method	Model
<p>1. The safety verification code of the controller does not match the setting of [Pr. PSC06 Safety verification code].</p>	<p>The controller may have communicated with an unintended servo amplifier. Check if the IP address designated in the safety communication settings of the master station matches the IP address setting of the servo amplifier being used.</p> <p>If the IP address is correct, the safety verification code may have been set incorrectly.</p> <p>Set the values used to identify each servo amplifier in [Pr. PSC06] avoiding duplication between each piece of equipment, then set the same values in the safety communication settings of the controller.</p>	[G]

[AL. 580.B_Safety verification code mismatch B]

☞ Page 231 [AL. 580.3_Safety verification code mismatch A]

[AL. 581_Safety communication error 1 (safety sub-function)]

- There is a problem with data reception in the safety communication.

[AL. 581.1_Safety communication error 1 - Receive data error A1 (safety sub-function)]

Cause	Check/action method	Model
1. The safety communication settings of the safety master station have been set incorrectly.	Review the safety communication settings. Refer to "Safety sub-function control by network" in the following manual. □MR-J5 User's Manual (Function)	[G]
2. There is a problem on the safety master station side.	Check if an alarm has occurred on the safety master station. If an alarm has occurred, take actions in accordance with the troubleshooting of the master station.	
3. Take actions in accordance with the items shown below. ☞ Page 104 [AL. 086.1_Network communication error 1]		

[AL. 581.2_Safety communication error 1 - Receive data error A2 (safety sub-function)]

☞ Page 232 [AL. 581.1_Safety communication error 1 - Receive data error A1 (safety sub-function)]

[AL. 581.3_Safety communication error 1 - Receive data error A3 (safety sub-function)]

☞ Page 232 [AL. 581.1_Safety communication error 1 - Receive data error A1 (safety sub-function)]

[AL. 581.4_Safety communication error 1 - Receive data error A4 (safety sub-function)]

☞ Page 232 [AL. 581.1_Safety communication error 1 - Receive data error A1 (safety sub-function)]

[AL. 581.5_Safety communication error 1 - Receive data error A5 (safety sub-function)]

☞ Page 232 [AL. 581.1_Safety communication error 1 - Receive data error A1 (safety sub-function)]

[AL. 581.6_Safety communication error 1 - Receive data error A6 (safety sub-function)]

☞ Page 232 [AL. 581.1_Safety communication error 1 - Receive data error A1 (safety sub-function)]

[AL. 581.7_Safety communication error 1 - Receive data error A7 (safety sub-function)]

☞ Page 232 [AL. 581.1_Safety communication error 1 - Receive data error A1 (safety sub-function)]

[AL. 581.9_Safety communication error 1 - Receive data error B1 (safety sub-function)]

☞ Page 232 [AL. 581.1_Safety communication error 1 - Receive data error A1 (safety sub-function)]

[AL. 581.A_Safety communication error 1 - Receive data error B2 (safety sub-function)]

☞ Page 232 [AL. 581.1_Safety communication error 1 - Receive data error A1 (safety sub-function)]

[AL. 581.B_Safety communication error 1 - Receive data error B3 (safety sub-function)]

☞ Page 232 [AL. 581.1_Safety communication error 1 - Receive data error A1 (safety sub-function)]

[AL. 581.C_Safety communication error 1 - Receive data error B4 (safety sub-function)]

☞ Page 232 [AL. 581.1_Safety communication error 1 - Receive data error A1 (safety sub-function)]

[AL. 581.D_Safety communication error 1 - Receive data error B5 (safety sub-function)]

☞ Page 232 [AL. 581.1_Safety communication error 1 - Receive data error A1 (safety sub-function)]

[AL. 581.E_Safety communication error 1 - Receive data error B6 (safety sub-function)]

Page 232 [AL. 581.1_Safety communication error 1 - Receive data error A1 (safety sub-function)]

[AL. 581.F_Safety communication error 1 - Receive data error B7 (safety sub-function)]

Page 232 [AL. 581.1_Safety communication error 1 - Receive data error A1 (safety sub-function)]

[AL. 582_Safety communication error 2 (safety sub-function)]

- There is a problem with data reception in the safety communication.

[AL. 582.1_Safety communication error 2 - Receive data error A1 (safety sub-function)]

☞ Page 232 [AL. 581.1_Safety communication error 1 - Receive data error A1 (safety sub-function)]

[AL. 582.2_Safety communication error 2 - Receive data error A2 (safety sub-function)]

☞ Page 232 [AL. 581.1_Safety communication error 1 - Receive data error A1 (safety sub-function)]

[AL. 582.3_Safety communication error 2 - Receive data error A3 (safety sub-function)]

☞ Page 232 [AL. 581.1_Safety communication error 1 - Receive data error A1 (safety sub-function)]

[AL. 582.4_Safety communication error 2 - Receive data error A4 (safety sub-function)]

☞ Page 232 [AL. 581.1_Safety communication error 1 - Receive data error A1 (safety sub-function)]

[AL. 582.5_Safety communication error 2 - Receive data error A5 (safety sub-function)]

☞ Page 232 [AL. 581.1_Safety communication error 1 - Receive data error A1 (safety sub-function)]

[AL. 582.6_Safety communication error 2 - Receive data error A6 (safety sub-function)]

☞ Page 232 [AL. 581.1_Safety communication error 1 - Receive data error A1 (safety sub-function)]

[AL. 582.7_Safety communication error 2 - Receive data error A7 (safety sub-function)]

☞ Page 232 [AL. 581.1_Safety communication error 1 - Receive data error A1 (safety sub-function)]

[AL. 582.9_Safety communication error 2 - Receive data error B1 (safety sub-function)]

☞ Page 232 [AL. 581.1_Safety communication error 1 - Receive data error A1 (safety sub-function)]

[AL. 582.A_Safety communication error 2 - Receive data error B2 (safety sub-function)]

☞ Page 232 [AL. 581.1_Safety communication error 1 - Receive data error A1 (safety sub-function)]

[AL. 582.B_Safety communication error 2 - Receive data error B3 (safety sub-function)]

☞ Page 232 [AL. 581.1_Safety communication error 1 - Receive data error A1 (safety sub-function)]

[AL. 582.C_Safety communication error 2 - Receive data error B4 (safety sub-function)]

☞ Page 232 [AL. 581.1_Safety communication error 1 - Receive data error A1 (safety sub-function)]

[AL. 582.D_Safety communication error 2 - Receive data error B5 (safety sub-function)]

☞ Page 232 [AL. 581.1_Safety communication error 1 - Receive data error A1 (safety sub-function)]

[AL. 582.E_Safety communication error 2 - Receive data error B6 (safety sub-function)]

☞ Page 232 [AL. 581.1_Safety communication error 1 - Receive data error A1 (safety sub-function)]

[AL. 582.F_Safety communication error 2 - Receive data error B7 (safety sub-function)]

☞ Page 232 [AL. 581.1_Safety communication error 1 - Receive data error A1 (safety sub-function)]

[AL. 583_Safety communication error 3 (safety sub-function)]

- There is a problem with data reception in the safety communication.

[AL. 583.2_Safety communication error 3 - Receive data error A2 (safety sub-function)]

☞ Page 232 [AL. 581.1_Safety communication error 1 - Receive data error A1 (safety sub-function)]

[AL. 583.3_Safety communication error 3 - Receive data error A3 (safety sub-function)]

☞ Page 232 [AL. 581.1_Safety communication error 1 - Receive data error A1 (safety sub-function)]

[AL. 583.4_Safety communication error 3 - Receive data error A4 (safety sub-function)]

☞ Page 232 [AL. 581.1_Safety communication error 1 - Receive data error A1 (safety sub-function)]

[AL. 583.5_Safety communication error 3 - Receive data error A5 (safety sub-function)]

☞ Page 232 [AL. 581.1_Safety communication error 1 - Receive data error A1 (safety sub-function)]

[AL. 583.6_Safety communication error 3 - Receive data error A6 (safety sub-function)]

☞ Page 232 [AL. 581.1_Safety communication error 1 - Receive data error A1 (safety sub-function)]

[AL. 583.A_Safety communication error 3 - Receive data error B2 (safety sub-function)]

☞ Page 232 [AL. 581.1_Safety communication error 1 - Receive data error A1 (safety sub-function)]

[AL. 583.B_Safety communication error 3 - Receive data error B3 (safety sub-function)]

☞ Page 232 [AL. 581.1_Safety communication error 1 - Receive data error A1 (safety sub-function)]

[AL. 583.C_Safety communication error 3 - Receive data error B4 (safety sub-function)]

☞ Page 232 [AL. 581.1_Safety communication error 1 - Receive data error A1 (safety sub-function)]

[AL. 583.D_Safety communication error 3 - Receive data error B5 (safety sub-function)]

☞ Page 232 [AL. 581.1_Safety communication error 1 - Receive data error A1 (safety sub-function)]

[AL. 583.E_Safety communication error 3 - Receive data error B6 (safety sub-function)]

☞ Page 232 [AL. 581.1_Safety communication error 1 - Receive data error A1 (safety sub-function)]

[AL. 584_FSoE communication setting error (safety sub-function)]

- There is a problem with the safety communication settings.

[AL. 584.1_FSoE Address mismatch error A (safety sub-function)]

Cause	Check/action method	Model
1. FSoE Address set in FSoE Master does not match the setting in [Pr. PSC07 FSoE Address setting].	Review the FSoE Address setting in FSoE Master or the setting in [Pr. PSC07 FSoE Address setting].	[G]

[AL. 584.2_FSoE communication parameter setting error A (safety sub-function)]

Cause	Check/action method	Model
1. The setting value of FSoE Watchdog Timer notified by FSoE Master is not supported.	Review the setting value of FSoE Watchdog Timer set in FSoE Master.	[G]

[AL. 584.3_FSoE communication parameter length error A (safety sub-function)]

Cause	Check/action method	Model
1. The parameter length notified by FSoE Master is incorrect.	Review the project setting in FSoE Master.	[G]

[AL. 584.4_FSoE SRA parameter setting error A (safety sub-function)]

Cause	Check/action method	Model
1. The SRA parameter notified by FSoE Master is incorrect.	Review the project setting in FSoE Master. If the SRA parameter is set, do not set it because it is not supported.	[G]

[AL. 584.5_FSoE SRA parameter length error A (safety sub-function)]

Cause	Check/action method	Model
1. The SRA parameter length notified by FSoE Master is incorrect.	Review the project setting in FSoE Master. If the SRA parameter is set, do not set it because it is not supported.	[G]

[AL. 584.9_FSoE Address mismatch error B (safety sub-function)]

☞ Page 236 [AL. 584.1_FSoE Address mismatch error A (safety sub-function)]

[AL. 584.A_FSoE communication parameter setting error B (safety sub-function)]

☞ Page 236 [AL. 584.2_FSoE communication parameter setting error A (safety sub-function)]

[AL. 584.B_FSoE communication parameter length error B (safety sub-function)]

☞ Page 236 [AL. 584.3_FSoE communication parameter length error A (safety sub-function)]

[AL. 584.C_FSoE SRA parameter setting error B (safety sub-function)]

☞ Page 236 [AL. 584.4_FSoE SRA parameter setting error A (safety sub-function)]

[AL. 584.D_FSoE SRA parameter length error B (safety sub-function)]

☞ Page 236 [AL. 584.5_FSoE SRA parameter length error A (safety sub-function)]

[AL. 585_FSoE communication error 1 (safety sub-function)]

- There is a problem with data reception in the safety communication. (During initial communication)

[AL. 585.1_FSoE communication error 1 - Receive data error (Unexpected command) A (safety sub-function)]

Cause	Check/action method	Model
1. The safety communication settings of FSoE Master are incorrect.	Review the safety communication settings. Refer to "Safety sub-function control by network" in the following manual. □□MR-J5-G-N1/MR-J5W-G-N1 User's Manual (Communication Function)	[G]
2. There is a problem with FSoE Master.	Check if an alarm has occurred in FSoE Master. If an alarm has occurred, take actions in accordance with the troubleshooting of FSoE Master.	
3. A network cable is disconnected.	Check if the network cable is connected correctly. Turn off the control circuit power supply of the servo amplifier, then connect the network cable correctly.	
4. The wiring of the network cable was incorrect.	Check if the connection of the network cable is correct.	
5. A network cable has been disconnected.	Check for disconnection in the network cable.	
6. Devices on the network (including repeaters such as hubs) are turned off.	Check that the devices on the network are turned on.	
7. The network was disconnected by an incorrect procedure.	Check if the network was disconnected by a correct procedure for each type of network. Refer to "Disconnecting the communication" in the User's Manual (Communication Function).	
8. Data transmission from the controller was interrupted for a certain time.	Check if data transmission from the controller has not been interrupted. If the data transmission has been interrupted, review the controller communication setting.	
9. The settings of the controller were incorrect.	Check the controller settings.	
10. There is a problem with the surrounding environment.	Check the noise, ambient temperature, and other conditions, and implement appropriate countermeasures for the cause. If there is noise, take countermeasures to reduce the noise. Refer to "Noise reduction techniques" in the following manuals. □□MR-J5 User's Manual (Hardware) □□MR-J5D User's Manual (Hardware)	
11. The servo amplifier has malfunctioned.	Replace the servo amplifier.	
12. The controller has malfunctioned.	Replace the controller.	
13. Devices on the network (including repeaters such as hubs) have malfunctioned.	Replace the devices on the network.	

[AL. 585.2_FSoE communication error 1 - Receive data error (Unknown command) A (safety sub-function)]

☞ Page 237 [AL. 585.1_FSoE communication error 1 - Receive data error (Unexpected command) A (safety sub-function)]

[AL. 585.3_FSoE communication error 1 - Receive data error (Invalid connection ID) A (safety sub-function)]

☞ Page 237 [AL. 585.1_FSoE communication error 1 - Receive data error (Unexpected command) A (safety sub-function)]

[AL. 585.4_FSoE communication error 1 - Receive data error (CRC error) A (safety sub-function)]

☞ Page 237 [AL. 585.1_FSoE communication error 1 - Receive data error (Unexpected command) A (safety sub-function)]

[AL. 585.9_FSoE communication error 1 - Receive data error (Unexpected command) B (safety sub-function)]

☞ Page 237 [AL. 585.1_FSoE communication error 1 - Receive data error (Unexpected command) A (safety sub-function)]

[AL. 585.A_FSoE communication error 1 - Receive data error (Unknown command) B (safety sub-function)]

☞ Page 237 [AL. 585.1_FSoE communication error 1 - Receive data error (Unexpected command) A (safety sub-function)]

[AL. 585.B_FSoE communication error 1 - Receive data error (Invalid connection ID) B (safety sub-function)]

☞ Page 237 [AL. 585.1_FSoE communication error 1 - Receive data error (Unexpected command) A (safety sub-function)]

[AL. 585.C_FSoE communication error 1 - Receive data error (CRC error) B (safety sub-function)]

☞ Page 237 [AL. 585.1_FSoE communication error 1 - Receive data error (Unexpected command) A (safety sub-function)]

[AL. 586_FSoE communication error 2 (safety sub-function)]

- There is a problem with data reception in the safety communication. (During runtime communication)

[AL. 586.1_FSoE communication error 2 - Receive data error (Unexpected command) A (safety sub-function)]

Cause	Check/action method	Model
1. The safety communication settings of FSoE Master are incorrect.	Review the safety communication settings. Refer to "Safety sub-function control by network" in the following manual. □□MR-J5-G-N1/MR-J5W-G-N1 User's Manual (Communication Function)	[G]
2. There is a problem with FSoE Master.	Check if an alarm has occurred in FSoE Master. If an alarm has occurred, take actions in accordance with the troubleshooting of FSoE Master.	
3. A network cable is disconnected.	Check if the network cable is connected correctly. Turn off the control circuit power supply of the servo amplifier, then connect the network cable correctly.	
4. The wiring of the network cable was incorrect.	Check if the connection of the network cable is correct.	
5. A network cable has been disconnected.	Check for disconnection in the network cable.	
6. Devices on the network (including repeaters such as hubs) are turned off.	Check that the devices on the network are turned on.	
7. The network was disconnected by an incorrect procedure.	Check if the network was disconnected by a correct procedure for each type of network. Refer to "Disconnecting the communication" in the User's Manual (Communication Function).	
8. Data transmission from the controller was interrupted for a certain time.	Check if data transmission from the controller has not been interrupted. If the data transmission has been interrupted, review the controller communication setting.	
9. The settings of the controller were incorrect.	Check the controller settings.	
10. There is a problem with the surrounding environment.	Check the noise, ambient temperature, and other conditions, and implement appropriate countermeasures for the cause. If there is noise, take countermeasures to reduce the noise. Refer to "Noise reduction techniques" in the following manuals. □□MR-J5 User's Manual (Hardware) □□MR-J5D User's Manual (Hardware)	
11. The servo amplifier has malfunctioned.	Replace the servo amplifier.	
12. The controller has malfunctioned.	Replace the controller.	
13. Devices on the network (including repeaters such as hubs) have malfunctioned.	Replace the devices on the network.	

[AL. 586.2_FSoE communication error 2 - Receive data error (Unknown command) A (safety sub-function)]

☞ Page 239 [AL. 586.1_FSoE communication error 2 - Receive data error (Unexpected command) A (safety sub-function)]

[AL. 586.3_FSoE communication error 2 - Receive data error (Invalid connection ID) A (safety sub-function)]

☞ Page 239 [AL. 586.1_FSoE communication error 2 - Receive data error (Unexpected command) A (safety sub-function)]

[AL. 586.4_FSoE communication error 2 - Receive data error (CRC error) A (safety sub-function)]

☞ Page 239 [AL. 586.1_FSoE communication error 2 - Receive data error (Unexpected command) A (safety sub-function)]

[AL. 586.5_FSoE communication error 2 - Receive time-out error A (safety sub-function)]

Cause	Check/action method	Model
1. The update time of the safety communication has exceeded the time set in FSoE Watchdog Time.	Review the setting value of FSoE Watchdog Time set in FSoE Master. Review the communication cycle setting.	[G]

[AL. 586.9_FSoE communication error 2 - Receive data error (Unexpected command) B (safety sub-function)]

☞ Page 239 [AL. 586.1_FSoE communication error 2 - Receive data error (Unexpected command) A (safety sub-function)]

[AL. 586.A_FSoE communication error 2 - Receive data error (Unknown command) B (safety sub-function)]

☞ Page 239 [AL. 586.1_FSoE communication error 2 - Receive data error (Unexpected command) A (safety sub-function)]

[AL. 586.B_FSoE communication error 2 - Receive data error (Invalid connection ID) B (safety sub-function)]

☞ Page 239 [AL. 586.1_FSoE communication error 2 - Receive data error (Unexpected command) A (safety sub-function)]

[AL. 586.C_FSoE communication error 2 - Receive data error (CRC error) B (safety sub-function)]

☞ Page 239 [AL. 586.1_FSoE communication error 2 - Receive data error (Unexpected command) A (safety sub-function)]

[AL. 586.D_FSoE communication error 2 - Receive time-out error B (safety sub-function)]

☞ Page 240 [AL. 586.5_FSoE communication error 2 - Receive time-out error A (safety sub-function)]

[AL. 587_FSoE communication error 3 (safety sub-function)]

- There is a problem with the safety communication.

[AL. 587.1_FSoE communication error 3 - Safety communication error 1A (safety sub-function)]

Cause	Check/action method	Model
1. The safety communication settings of FSoE Master are incorrect.	Review the safety communication settings. Refer to "Safety sub-function control by network" in the following manual. □□MR-J5-G-N1/MR-J5W-G-N1 User's Manual (Communication Function)	[G]
2. There is a problem with FSoE Master.	Check if an alarm has occurred in FSoE Master. If an alarm has occurred, take actions in accordance with the troubleshooting of FSoE Master.	
3. A network cable is disconnected.	Check if the network cable is connected correctly. Turn off the control circuit power supply of the servo amplifier, then connect the network cable correctly.	
4. The wiring of the network cable was incorrect.	Check if the connection of the network cable is correct.	
5. A network cable has been disconnected.	Check for disconnection in the network cable.	
6. Devices on the network (including repeaters such as hubs) are turned off.	Check that the devices on the network are turned on.	
7. The network was disconnected by an incorrect procedure.	Check if the network was disconnected by a correct procedure for each type of network. Refer to "Disconnecting the communication" in the User's Manual (Communication Function).	
8. Data transmission from the controller was interrupted for a certain time.	Check if data transmission from the controller has not been interrupted. If the data transmission has been interrupted, review the controller communication setting.	
9. The settings of the controller were incorrect.	Check the controller settings.	
10. There is a problem with the surrounding environment.	Check the noise, ambient temperature, and other conditions, and implement appropriate countermeasures for the cause. If there is noise, take countermeasures to reduce the noise. Refer to "Noise reduction techniques" in the following manuals. □□MR-J5 User's Manual (Hardware) □□MR-J5D User's Manual (Hardware)	
11. The servo amplifier has malfunctioned.	Replace the servo amplifier.	
12. The controller has malfunctioned.	Replace the controller.	
13. Devices on the network (including repeaters such as hubs) have malfunctioned.	Replace the devices on the network.	

[AL. 587.2_FSoE communication error 3 - Safety communication error 2A (safety sub-function)]

☞ Page 241 [AL. 587.1_FSoE communication error 3 - Safety communication error 1A (safety sub-function)]

[AL. 587.3_FSoE communication error 3 - Safety communication error 3A (safety sub-function)]

☞ Page 241 [AL. 587.1_FSoE communication error 3 - Safety communication error 1A (safety sub-function)]

[AL. 587.4_FSoE communication error 3 - Safety communication error 4A (safety sub-function)]

☞ Page 241 [AL. 587.1_FSoE communication error 3 - Safety communication error 1A (safety sub-function)]

[AL. 587.5_FSoE communication error 3 - Safety communication error 5A (safety sub-function)]

☞ Page 241 [AL. 587.1_FSoE communication error 3 - Safety communication error 1A (safety sub-function)]

[AL. 587.6_FSoE communication error 3 - Safety communication error 6A (safety sub-function)]

☞ Page 241 [AL. 587.1_FSoE communication error 3 - Safety communication error 1A (safety sub-function)]

[AL. 587.7_FSoE communication error 3 - Safety communication error 7A (safety sub-function)]

☞ Page 241 [AL. 587.1_FSoE communication error 3 - Safety communication error 1A (safety sub-function)]

[AL. 587.9_FSoE communication error 3 - Safety communication error 1B (safety sub-function)]

☞ Page 241 [AL. 587.1_FSoE communication error 3 - Safety communication error 1A (safety sub-function)]

[AL. 587.A_FSoE communication error 3 - Safety communication error 2B (safety sub-function)]

☞ Page 241 [AL. 587.1_FSoE communication error 3 - Safety communication error 1A (safety sub-function)]

[AL. 587.B_FSoE communication error 3 - Safety communication error 3B (safety sub-function)]

☞ Page 241 [AL. 587.1_FSoE communication error 3 - Safety communication error 1A (safety sub-function)]

[AL. 587.C_FSoE communication error 3 - Safety communication error 4B (safety sub-function)]

☞ Page 241 [AL. 587.1_FSoE communication error 3 - Safety communication error 1A (safety sub-function)]

[AL. 587.D_FSoE communication error 3 - Safety communication error 5B (safety sub-function)]

☞ Page 241 [AL. 587.1_FSoE communication error 3 - Safety communication error 1A (safety sub-function)]

[AL. 587.E_FSoE communication error 3 - Safety communication error 6B (safety sub-function)]

☞ Page 241 [AL. 587.1_FSoE communication error 3 - Safety communication error 1A (safety sub-function)]

[AL. 587.F_FSoE communication error 3 - Safety communication error 7B (safety sub-function)]

☞ Page 241 [AL. 587.1_FSoE communication error 3 - Safety communication error 1A (safety sub-function)]

[AL. 595_STO command off warning (safety sub-function)]

- The STO command has been turned off.

[AL. 595.1_STO command off warning A]

Cause	Check/action method	Model
1. The STO command of the functional safety has been turned off (enabled).	Turn on (disable) the STO command of the functional safety.	[G]

[AL. 595.9_STO command off warning B]

☞ Page 243 [AL. 595.1_STO command off warning A]

[AL. 596_SS1 time-out warning (safety sub-function)]

- The deceleration monitor time has passed after the SS1 command was turned off.

[AL. 596.1_SS1 time-out warning A]

Cause	Check/action method	Model
1. The time set in [Pr. PSA03 SS1/SS2 deceleration monitor time] has passed after the SS1 command was turned off (enabled).	Turn on (disable) the SS1 command.	[G]
2. With [Pr. PSA02.2 Time/Deceleration monitor setting] being set to "1" (perform deceleration monitoring) and "off" (enabled) of the SS1 command being detected, the time set in [Pr. PSA15 Safety sub-function - Speed detection delay time] has passed since the servo motor speed fell below the setting value of [Pr. PSA04 Safety sub-function - Stop speed].		

[AL. 596.9_SS1 time-out warning B]

☞ Page 244 [AL. 596.1_SS1 time-out warning A]

[AL. 59D_Internal diagnosis error (safety sub-function)]

- There is an error with the result from functional safety diagnosis.

[AL. 59D.1_Internal diagnosis error A1 (safety sub-function)]

Cause	Check/action method	Model
1. The servo amplifier has malfunctioned.	Replace the servo amplifier.	[G]
2. There is a problem with the surrounding environment.	Check the noise, ambient temperature, and other conditions, and implement appropriate countermeasures for the cause. If there is noise, take countermeasures to reduce the noise. Refer to "Noise reduction techniques" in the following manuals. <ul style="list-style-type: none"> 📖 MR-J5 User's Manual (Hardware) 📖 MR-J5D User's Manual (Hardware) 	

[AL. 59D.3_Internal diagnosis error A3 (safety sub-function)]

📖 Page 245 [AL. 59D.1_Internal diagnosis error A1 (safety sub-function)]

[AL. 59D.6_Internal diagnosis error A6 (safety sub-function)]

📖 Page 245 [AL. 59D.1_Internal diagnosis error A1 (safety sub-function)]

[AL. 59D.9_Internal diagnosis error B1 (safety sub-function)]

📖 Page 245 [AL. 59D.1_Internal diagnosis error A1 (safety sub-function)]

[AL. 59D.B_Internal diagnosis error B3 (safety sub-function)]

📖 Page 245 [AL. 59D.1_Internal diagnosis error A1 (safety sub-function)]

[AL. 59D.E_Internal diagnosis error B6 (safety sub-function)]

📖 Page 245 [AL. 59D.1_Internal diagnosis error A1 (safety sub-function)]

[AL. 5E0_Safety input device fixing diagnosis incomplete warning]

- The input device diagnosis has not been executed.

[AL. 5E0.1_SDI1 fixing diagnosis at startup incomplete warning A (safety sub-function)]

Cause	Check/action method	Model
1. A fixing diagnosis at startup has not been executed.	Check if a fixing diagnosis at startup has been executed.	[G]
2. The fixing diagnosis at startup has been set incorrectly in the functional safety parameter.	Check if [Pr. PSD27 Input device - Fixing diagnosis at startup execution selection 1] has been set correctly.	
3. The wiring is incorrect.	Check if the wiring is correct.	
4. The servo amplifier has malfunctioned.	Replace the servo amplifier.	
5. There is a problem with the surrounding environment.	Check the noise, ambient temperature, and other conditions, and implement appropriate countermeasures for the cause. If there is noise, take countermeasures to reduce the noise. Refer to "Noise reduction techniques" in the following manuals. <input type="checkbox"/> MR-J5 User's Manual (Hardware) <input type="checkbox"/> MR-J5D User's Manual (Hardware)	

[AL. 5E0.2_SDI2 fixing diagnosis at startup incomplete warning A (safety sub-function)]

☞ Page 246 [AL. 5E0.1_SDI1 fixing diagnosis at startup incomplete warning A (safety sub-function)]

[AL. 5E0.3_SDI3 fixing diagnosis at startup incomplete warning A (safety sub-function)]

☞ Page 246 [AL. 5E0.1_SDI1 fixing diagnosis at startup incomplete warning A (safety sub-function)]

[AL. 5E0.7_Fixing diagnosis - No detection of all input ON A (safety sub-function)]

☞ Page 246 [AL. 5E0.1_SDI1 fixing diagnosis at startup incomplete warning A (safety sub-function)]

[AL. 5E0.9_SDI1 fixing diagnosis at startup incomplete warning B (safety sub-function)]

☞ Page 246 [AL. 5E0.1_SDI1 fixing diagnosis at startup incomplete warning A (safety sub-function)]

[AL. 5E0.A_SDI2 fixing diagnosis at startup incomplete warning B (safety sub-function)]

☞ Page 246 [AL. 5E0.1_SDI1 fixing diagnosis at startup incomplete warning A (safety sub-function)]

[AL. 5E0.B_SDI3 fixing diagnosis at startup incomplete warning B (safety sub-function)]

☞ Page 246 [AL. 5E0.1_SDI1 fixing diagnosis at startup incomplete warning A (safety sub-function)]

[AL. 5E0.F_Fixing diagnosis - No detection of all input ON B (safety sub-function)]

☞ Page 246 [AL. 5E0.1_SDI1 fixing diagnosis at startup incomplete warning A (safety sub-function)]

[AL. 5E1_Test mode setting mismatch warning (safety sub-function)]

- The settings for the test mode are inconsistent.

[AL. 5E1.1_Test mode setting mismatch warning A (safety sub-function)]

Cause	Check/action method	Model
1. The test operation mode has been set incorrectly.	Check if the servo amplifier and [Pr. PSA01.1 Input mode selection] are both set for test mode. If they do not match, review the settings.	[G]

[AL. 5E1.9_Test mode setting mismatch warning B (safety sub-function)]

☞ Page 247 [AL. 5E1.1_Test mode setting mismatch warning A (safety sub-function)]

[AL. 5E2_Safety communication warning (safety sub-function)]

- There is a problem with the safety communication.

[AL. 5E2.1_Safety communication no connection warning A (safety sub-function)]

Cause	Check/action method	Model
1. Connection with the controller has not been established.	☞ Page 250 The display shows "A" (unconnected to the controller)	[G]
2. The safety communication settings are incorrect.	Review the safety communication settings. Refer to "Safety sub-function control by network" in the following manual. ☞ MR-J5 User's Manual (Function)	
3. The IP address was changed after connecting to the controller.	If the IP address of the controller or the servo amplifier was changed after connecting the controller, cycle the power.	

[AL. 5E2.2_FSoE communication no connection warning A (safety sub-function)]

Cause	Check/action method	Model
1. Connection with the controller has not been established.	☞ Page 250 The display shows "A" (unconnected to the controller)	[G]
2. The safety communication settings are incorrect.	Review the safety communication settings. Refer to "Safety sub-function control by network" in the following manual. ☞ MR-J5-G-N1/MR-J5W-G-N1 User's Manual (Communication Function)	

[AL. 5E2.9_Safety communication no connection warning B (safety sub-function)]

☞ Page 248 [AL. 5E2.1_Safety communication no connection warning A (safety sub-function)]

[AL. 5E2.A_FSoE communication no connection warning B (safety sub-function)]

☞ Page 248 [AL. 5E2.2_FSoE communication no connection warning A (safety sub-function)]

[AL. 5E6_SS1 command off warning (safety sub-function)]

- The SS1 command was turned off.

[AL. 5E6.1_SS1 command off warning A (safety sub-function)]

Cause	Check/action method	Model
1. The SS1 command has been turned off (enabled).	Turn on (disable) the SS1 command.	[G]
2. An external 24 V DC power supply has not been input to the safety input signal terminal.	Input the 24 V DC power supply.	
3. The servo amplifier has malfunctioned.	Replace the servo amplifier.	

[AL. 5E6.9_SS1 command off warning B (safety sub-function)]

☞ Page 249 [AL. 5E6.1_SS1 command off warning A (safety sub-function)]

1.4 Trouble which does not trigger an alarm/warning

This section shows examples of trouble which will not trigger an alarm or warning as well as the possible causes of such trouble. Refer to this section and remove each cause of trouble.

Precautions

- When the servo amplifier, servo motor, controller, or encoder malfunctions, the cases shown in this section may occur.
- If the servo motor does not rotate, also check the "No Motor Rotation" area in MR Configurator2.

The display shows "A" (unconnected to the controller)

[G]: The status of each axis is indicated in each digit.

1-axis servo amplifier: "A _ _"

2-axis servo amplifier: "AA _"

3-axis servo amplifier: "AAA"

[B]: "AA _" or "Ab _" appears.

Possible cause	Check/action method	Model
1. The power supply of the controller has been turned off.	Switch on the power of the controller.	[G] [B]
2. The power supply of the device between the controller and servo amplifier has been turned off.	Turn on the power of the device between the controller and servo amplifier.	
3. The amplifier-less operation function of the controller is enabled.	Cancel the amplifier-less operation function of the controller.	
4. A network cable was disconnected.	Replace the network cable. [G]: Ethernet cable [B]: SSCNET III cable Check if the connector (CN1A/CN1B) is disconnected.	
5. An incompatible controller is connected. Or, the network settings of the controller and the network settings of the servo amplifiers do not match.	Connect with a compatible controller. Check that the controller and servo amplifiers use the same network type. Check that the current network settings displayed in "System Configuration" of MR Configurator2 and the network settings of the controller match. Review the setting value of [Pr. PN13 Network protocol setting (**NPS)].	[G]
	Check if the version of the controller is compatible with the MR-J5_-_B_. Refer to the controller manual for the confirmation method. Check if the servo series settings of the controller are correct.	[B]
6. The settings of the rotary switch are incorrect.	Check if there is another servo amplifier assigned to the same axis No. Check if the settings of the controller and servo amplifiers are correct.	[G] [B]
7. The communication cycle does not match.	Refer to the controller instruction manual and check the communication cycle.	
	Check the communication error detection time of the servo amplifier.	[G]
8. The communication speed (1 Gbps, 100 Mbps, or 10 Mbps) does not match between the controller and servo amplifiers.	Check that the communication speeds of the controller and servo amplifiers are the same.	[G]
9. For a multi-axis servo amplifier, the axis has been disabled.	Turn off the disabling control axis switch.	[G] [B]

The display shows "r###"

Possible cause	Check/action method	Model
1. The system is in servo-off or ready-off state. (## in the display indicates network addresses.)	Turn on the servo-on for all the axes.	[G]

The display shows "b###"

Possible cause	Check/action method	Model
1. The test operation mode is enabled.	Turn off the test operation select switch (SW3-1). Refer to "Switch setting and display of the servo amplifier" in the User's Manual (Introduction).	[B]
2. The system is in servo-off or ready-off state.	Turn on the servo-on for all the axes.	

The display shows "TST"

Possible cause	Check/action method	Model
1. The test operation mode is enabled.	Turn off the test operation select switch (SW3-1). Refer to "Switch setting and display of the servo amplifier" or "Switch setting and display of the drive unit" in the User's Manual (Introduction).	[G]

The display shows "off"

Possible cause	Check/action method	Model
1. The operation mode for manufacturer setting is enabled.	Do not turn on all the DIP switches (SW3). Set SW3 correctly. Refer to "Switch setting and display of the servo amplifier" or "Switch setting and display of the drive unit" in the User's Manual (Introduction).	[G] [B]
	Cycle the power.	[A]

The display shows "SET"

Possible cause	Check/action method	Model
1. The IP address setting from the controller failed in GX Works3.	Cycle the power.	[G]

The display shows "ECT" or "EIP"

Possible cause	Check/action method	Model
1. The network setup mode is enabled.	Turn off the network setup switch (SW3-2) or disabling control axis switch (SW3-2, SW3-3, SW3-4).	[G]

The display is off

Possible cause	Check/action method	Model
1. The external I/O terminal has shorted.	If disconnecting the Ethernet cable connector, encoder connector, and I/O signal connector solves the trouble, the cable wiring may have shorted. Review the wiring.	[G] [B] [A]
2. The power has not been supplied to the control circuit.	Turn on the control circuit power supply.	
3. The voltage of the control circuit power supply has dropped.	Increase the voltage of the control circuit power supply.	

The servo motor does not operate

Possible cause	Check/action method	Model
1. The connection of the servo motor is incorrect.	Check the U/V/W wiring. Refer to "Example power circuit connections" in the following manuals. <input type="checkbox"/> MR-J5 User's Manual (Hardware) <input type="checkbox"/> MR-J5D User's Manual (Hardware)	[G] [B] [A]
2. A servo motor power cable or an encoder cable is connected to an incorrect axis.	Check if the encoder cable and the servo motor power cable are connected to the same axis.	
3. An alarm or warning is occurring.	Check the contents of the alarm or warning, and remove its cause.	
4. The system is in the test operation mode. [G] [B]: Test operation select switch (SW3-1) has been turned on (up). [A]: The point in the lower right of the display is blinking.	Cancel the test operation mode.	
5. The motor-less operation has been enabled.	Disable the motor-less operation. [G] [B]: [Pr. PC05.0 Motor-less operation selection] [A]: [Pr. PC60.0 Motor-less operation selection]	
6. The torque is insufficient for the large load.	Check the instantaneous torque on the status display ([A]) or with MR Configurator2. If the torque reaches the maximum torque or the torque limit value, reduce the load or replace the servo motor with a larger-capacity servo motor.	
7. An unintended torque limit has been enabled.	Cancel the torque limit.	
8. The setting value for the torque limit is incorrect.	Check if the torque limit value is "0". Refer to "Torque limit" in the following manual. <input type="checkbox"/> MR-J5 User's Manual (Function)	
9. The machine is interfering with the servo motor.	Remove the interference.	
10. For a servo motor with an electromagnetic brake, the brake has not been released.	Turn on the electromagnetic brake power.	
11. LSP (Forward rotation stroke end) and LSN (Reverse rotation stroke end) are not on.	Check if [AL. 099 Stroke limit warning] has occurred. Turn on LSP and LSN.	[G] [A]
12. FLS (Upper stroke limit) and RLS (Lower stroke limit) are not turned on.	Check if [AL. 099 Stroke limit warning] has occurred. Turn on FLS and RLS.	[G] [B]
13. A software position limit is reached.	Check if [AL. 098 Software position limit warning] has occurred. Place the moving part in the range of the software position limit.	[G]
14. The servo-on has not been turned on.	Turn on the servo-on.	[G]
15. The settings of the electronic gear are incorrect.	Set appropriate values for the electronic gear.	[B] [A]
16. The setting value of the point table is incorrect.	Review the setting value of the point table.	[G]

Possible cause	Check/action method	Model
17. RES (Reset) has been switched on.	Switch off RES.	[A]
18. The setting of the control mode is incorrect.	Check the setting of [Pr. PA01.0 Control mode selection].	
19. In the position control mode, the command pulse has not been input.	Check if the pulse train has been input from the controller.	
20. In the position control mode, wiring of the command pulse train signal is incorrect.	Review the wiring. Input 24 V DC to OPC when using the signal in the open-collector type.	
21. In the position control mode, the settings of the command pulse input form are incorrect.	Check that the pulse train form output by the controller corresponds to the setting of [Pr. PA13.0 Command input pulse train - Form selection].	
22. Both ST1 (Forward rotation start) and ST2 (Reverse rotation start) are on, or both are off in the speed control mode or the positioning mode.	Switch on either one of ST1 or ST2.	
23. Both RS1 (Forward rotation selection) and RS2 (Reverse rotation selection) are on, or both are off in the torque control mode.	Switch on either one of RS1 or RS2.	
24. The value selected in the speed control mode and the torque control mode is too low.	Review the settings of the internal speed and the selections of SP1 (Speed selection 1), SP2 (Speed selection 2), and SP3 (Speed selection 3).	
25. An analog signal has not been input correctly.	Check the values of the analog speed command and the analog torque command on the status display or on MR Configurator2. Input the analog signal correctly.	
26. The ABS transfer mode has been selected in the absolute position detection system.	Turn off ABSM.	
27. Power has not been supplied to OPC (Open collector - Sync interface power supply input).	Connect between DICOM and OPC of the CN3 connector of the servo amplifier.	
28. The setting/specification of the point table number selection is incorrect.	Check the [Target point table (Obj. 2D60h)] setting.	[G]
29. Quick Stop has been activated.	Cancel Quick Stop.	
30. Halt has been activated.	Cancel Halt.	
31. An error is occurring on the controller side.	Remove the error of the controller.	[G]
32. The parameter settings are incorrect on the controller side.	Review the parameter settings on the controller side.	[B]
33. The position command has not been input correctly.	Review the settings of the controller or the servo program.	
34. For a multi-axis servo amplifier, the axis has been disabled.	Check if the disabling control axis switch has not been turned on.	
35. PEN was not turned on while the input signal was being set to PEN (Command input permission signal).	Check if PEN (Command input permission signal) has been turned on. Check if PENS (Command pulse train input permitted) has been turned on.	[A]

The increase in the servo motor speed is insufficient or excessive

Possible cause	Check/action method	Model
1. The settings of the speed command, speed limit, or electronic gear are incorrect.	Review the settings of the speed command, speed limit, and electronic gear.	[G] [B] [A]
2. The connection of the servo motor is incorrect.	Check the U/V/W wiring. Refer to "Example power circuit connections" in the following manuals. <input type="checkbox"/> MR-J5 User's Manual (Hardware) <input type="checkbox"/> MR-J5D User's Manual (Hardware)	
3. The voltage of the main circuit power supply has dropped.	Increase the voltage of the main circuit power supply.	
4. For a servo motor with an electromagnetic brake, the brake has not been released.	Turn on the electromagnetic brake power.	
5. The selection of SP1 (Speed selection 1), SP2 (Speed selection 2), or SP3 (Speed selection 3) is incorrect in the speed control mode and the torque control mode.	Review the settings of SP1, SP2, SP3, and setting of the internal speed.	[A]
6. The analog signal was incorrectly input in the speed control mode and the torque control mode.	Check the values of the analog speed command and the analog torque command on the status display or on MR Configurator2.	
7. When the override function is enabled, the override value is set incorrectly.	Review the setting of [Speed override (Obj. 2DB0h)].	[G]



Vibration of servo motor at low frequency

Possible cause	Check/action method	Model
1. The estimated value of the load to motor inertia ratio by auto tuning is incorrect. The value of the load to motor inertia ratio which was set manually is incorrect.	Execute the auto tuning or one-touch tuning to set the load to motor inertia ratio again. When setting manually, set the load to motor inertia ratio correctly. Refer to "ADJUSTMENT METHOD" in the following manual. <input type="checkbox"/> MR-J5 User's Manual (Adjustment)	[G] [B] [A]
2. The command from the controller is unstable.	Review the command from the controller. Check if the Ethernet cable or SSCNET III cable is disconnected or has other problems.	
3. When the servo motor stops, torque or thrust at acceleration/deceleration overshoots exceeding the limit of the servo motor.	If the torque at acceleration/deceleration reaches the maximum torque, reduce the generated torque by increasing the acceleration/deceleration time, reducing the load, or other measures.	
4. The servo gain is too low or the response of the auto tuning is too low.	Increase the servo gain or the value of [Pr. PA09 Auto tuning response].	

There is an unusual noise in the servo motor

Possible cause	Check/action method	Model
1. The servo gain is too high or the response of the auto tuning is too high.	Increase the servo gain or the value of [Pr. PA09 Auto tuning response].	[G] [B] [A]
2. The bearing has reached the end of its service life.	If the servo motor can be operated safely, remove the load and check for the noise in the servo motor itself. If the servo motor is removable from the machine, remove the servo motor power cable, then release the brake, and rotate the servo motor by an external force to check for a noise. If a noise occurs, the bearing is at the end of its service life. Replace the servo motor. If no noise occurs, perform maintenance on the load side.	
3. For a servo motor with an electromagnetic brake, the brake has not been released.	Turn on the electromagnetic brake power.	
4. When a servo motor with an electromagnetic brake is used, the brake release timing is incorrect.	Review the timing of the electromagnetic brake release. Take into account that the electromagnetic brake has a release delay time.	

The servo motor vibrates

Possible cause	Check/action method	Model
1. The servo gain is too high or the response of the auto tuning is too high.	Decrease the servo gain to check if the trouble is solved or decrease the value of [Pr. PA09 Auto tuning response].	[G] [B] [A]
2. The machine is vibrating (resonating).	Perform one-touch tuning or adaptive tuning, or set the machine resonance suppression filter.	
3. The load side is vibrating.	Perform vibration suppression control tuning or set the vibration suppression control.	
4. Noise entered the encoder cable, causing the miscount of the feedback pulses.	Check if numerical values of the cumulative feedback pulses are skipped on the status display ([A]) or with MR Configurator2. Take countermeasures against noise, such as laying the encoder cable apart from the power cables.	
5. There is a backlash between the servo motor and machine (such as a gear and coupling).	If the coupling and the mechanical part are nearly broken, or there is a backlash, perform an inspection and maintenance.	
6. The rigidity of the servo motor mounting part is too low.	Increase the rigidity of the mounting part by increasing the board thickness, reinforcing the part with ribs, or other means.	
7. The connection of the servo motor is incorrect.	Check the U/V/W wiring. Refer to "Example power circuit connections" in the following manuals.  MR-J5 User's Manual (Hardware)  MR-J5D User's Manual (Hardware)	
8. An unbalanced torque of the machine is too large.	Check if the vibration also changes as the servo motor speed changes. Adjust the balance of the machine.	
9. The eccentricity due to a core gap is too large.	Check the mounting accuracy of the servo motor and machine.	
10. A load for the shaft of the servo motor is too large.	Make the load for the shaft of the servo motor equal to or less than the permissible load of the servo motor. Refer to "Standard specifications list" in the following manual.  Rotary Servo Motor User's Manual (For MR-J5)	
11. An external vibration propagated to the servo motor.	Prevent the vibration from the external vibration source.	

Poor speed accuracy (Unstable speed of servo motor)

Possible cause	Check/action method	Model
1. The servo gain is too low or the response of auto tuning is too low.	Increase the servo gain or the value of [Pr. PA09 Auto tuning response].	[G] [B] [A]
2. The servo gain is too high or the response of the auto tuning is too high.	Decrease the servo gain to check if the trouble is solved. Alternatively, decrease the value of [Pr. PA09].	
3. The torque is insufficient for the large load.	Check the instantaneous torque on the status display ([A]) or with MR Configurator2. If the torque reaches the maximum torque or the torque limit value, reduce the load or replace the servo motor with a larger-capacity servo motor.	
4. An unintended torque limit has been enabled.	On the status display or MR Configurator2, check if TLC (Limiting torque) is turned on. Cancel the torque limit. Refer to "Torque limit" in the following manual. MR-J5 User's Manual (Function)	
5. The setting value for the torque limit is incorrect.	Increase the torque limit value. Refer to "Torque limit" in the following manual. MR-J5 User's Manual (Function)	
6. For a servo motor with an electromagnetic brake, the brake has not been released.	Turn on the electromagnetic brake power.	
7. The command from the controller is unstable.	Review the command from the controller. Alternatively, check if the Ethernet cable or SSCNET III cable is disconnected or has other problems.	
8. The power supply voltage is lower than specifications.	Adjust the power supply voltage within the range of specifications.	

The machine vibrates unsteadily when it stops

Possible cause	Check/action method	Model
1. The servo gain is too low or the response of auto tuning is too low.	Increase the servo gain or the value of [Pr. PA09 Auto tuning response].	[G] [B] [A]

Overshoot/undershoot occurs

Possible cause	Check/action method	Model
1. The servo gain is too low or too high. The response of auto tuning is too low or too high.	Adjust the response of auto tuning and readjust the gain.	[G] [B] [A]
2. The setting of [Pr. PB06 Load to motor inertia ratio/load to motor mass ratio] is incorrect.	Check if the setting value of [Pr. PB06] matches the actual load moment of inertia or load mass. If the value does not match, set the parameter correctly.	
3. The maximum torque is insufficient due to the excessive load or the capacity of the servo motor is insufficient.	Check the instantaneous torque on the status display. Check if the torque reaches the torque limit value. Keep the torque outside the torque limit value by increasing the acceleration/deceleration time or by reducing the load. Alternatively, use a servo motor with a larger capacity.	
4. The setting of the torque limit value is too small.	Check the instantaneous torque on the status display. Check if the torque reaches the torque limit value. Increase the torque limit value so that the torque does not reach the limit value.	
5. The backlash of the machine part is too large.	Perform an inspection and maintenance of the coupling and the machine.	

The servo motor starts moving immediately after the power-on of the servo amplifier or servo-on

Possible cause	Check/action method	Model
1. The SON (Servo-on) had been already turned on at power-on.	Review the wiring or the sequence program.	[A]
2. ST1 (Forward rotation start) or ST2 (Reverse rotation start) had already been input at the start.	Review the wiring or the sequence program.	
3. An analog signal had already been input at the start.	Review the timing of inputting analog signals.	
4. The zero point of an analog signal has deviated.	If the servo motor rotates with 0 V input for the analog signal, execute the VC automatic offset, or adjust the offset of the analog signal with [Pr. PC37 Analog command input 1 offset] or [Pr. PC38 Analog command input 2 offset].	
5. A command pulse was input from the controller.	Review the controller programs.	
6. Wiring of a command pulse train is incorrect, causing command pulses to be miscounted.	Check for any disconnected wiring of the command pulse train and any loose connection with the terminal. If there is any problems, correct the wiring of the command pulse train.	
7. When a servo motor with an electromagnetic brake is used, the brake release timing is incorrect.	Review the timing of the electromagnetic brake release.	[G] [B] [A]
8. The connection of the servo motor is incorrect.	Check the U/V/W wiring. Refer to "Example power circuit connections" in the following manuals. <ul style="list-style-type: none"> ☞ MR-J5 User's Manual (Hardware) ☞ MR-J5D User's Manual (Hardware) 	
9. The control mode was switched without performing position follow-up on the controller side.	Perform position follow-up on the controller side before switching the control mode.	[G] [B]

The home position deviates at the homing

Possible cause	Check/action method	Model
1. When performing the dog type homing, the point where the proximity dog turns off is close to the point where a Z-phase pulse is detected (CR input position).	Check if a fixed amount (in one revolution) deviates. Adjust the position of the proximity dog.	[G] [B] [A]
2. The in-position range is too large.	Set the value in [Pr. PA10 In-position range] for a narrower range than the current setting.	
3. The proximity dog switch has malfunctioned or the proximity dog switch is improperly mounted.	Repair or replace the proximity dog switch. Adjust the mounting of the proximity dog switch.	
4. The program on the controller side is incorrect.	Review the program on the controller side, such as home position address settings and sequence programs.	
5. An incorrect homing method has been selected.	Review the homing method selection.	

The position deviates during operation after the homing

Possible cause	Check/action method	Model
1. The electronic gear is incorrect.	Review the settings of the electronic gear. Refer to "Electronic gear function" in the following manual. ☞MR-J5 User's Manual (Function)	[G] [B] [A]
2. The servo gain is too low or the response of auto tuning is too low.	Check if the trouble is solved by increasing the value of [Pr. PA09 Auto tuning response]. Adjust the servo gain.	
3. The proportional control (PID control) is enabled.	Disable the proportional control (PID control).	
4. The in-position range is too large.	Review the setting value of [Pr. PA10 In-position range].	
5. Mechanical slippage occurred or the backlash of the mechanical part is too large.	Check for a slippage or backlash in the mechanical part.	[G] [B]
	Check for a slippage or backlash in the mechanical part. Refer to "Investigating the cause of a position mismatch" in the following manual. ☞MR-J5-A User's Manual (Introduction)	[A]
6. The command pulses were miscounted due to noise.	If the command value of the controller does not match the number of cumulative command pulses, perform the noise reduction techniques on the command cables, or review the shield procedure of the command cable. Refer to "Investigating the cause of a position mismatch" in the following manual. ☞MR-J5-A User's Manual (Introduction)	
7. The command cable is loosely connected or disconnected.	If the command value of the controller does not match the number of cumulative command pulses, repair the command cable.	
8. The pulse train command frequency exceeded the specification range.	Use the pulse train command frequency within the range of specifications. Open-collector type: 500 kpulses/s or less. Differential line driver type: 4 Mpulses/s or less. Set [Pr. PA13.2 Command input pulse train filter selection] according to the pulse train command frequency.	
9. The command cable is too long.	Shorten the wiring length. Differential line driver type: 10 m or less. Open-collector type: 2 m or less.	
10. SON (Servo-on) turned off during operation.	Review the wiring or sequence program so that SON does not turn off during operation. Refer to "Investigating the cause of a position mismatch" in the following manual. ☞MR-J5-A User's Manual (Introduction)	
11. LSP (Forward rotation stroke end) or LSN (Reverse rotation stroke end) turned off.	Review the operation range or the position of the stroke end. Refer to "Investigating the cause of a position mismatch" in the following manual. ☞MR-J5-A User's Manual (Introduction)	
12. CR (Clear) or RES (Reset) turned on during operation.	Review the wiring or sequence so that CR or RES does not turn on during operation. Refer to "Investigating the cause of a position mismatch" in the following manual. ☞MR-J5-A User's Manual (Introduction)	

A position mismatch occurs at power restoration in an absolute position detection system

Possible cause	Check/action method	Model
1. While the servo amplifier was in power-off status, an external force rotated the servo motor at a speed exceeding the maximum permissible speed at power failure (8000 r/min). (The acceleration time was 0.2 s or less.)	Extend the acceleration time. Keep the speed under the maximum permissible speed at power failure.	[G] [B] [A]
2. When the servo motor was rotated at a speed exceeding 3000 r/min by an external force, the servo amplifier power was turned on.	Check if the servo amplifier power was turned on when the servo motor was rotated at a speed exceeding 3000 r/min by an external force.	
3. Transfer data to the controller is incorrect.	Check the ABS data with MR Configurator2. Review the controller programs.	[A]

Communication with the servo amplifier fails using MR Configurator2

- For details, refer to the "HELP" window in MR Configurator2.

Possible cause	Check/action method	Model
1. The communication settings are incorrect.	Check the communication settings, such as the baud rate and ports.	[G]
2. The model being connected differs from the model set in the model selection.	Check if the model selection has been set correctly.	[B] [A]
3. The driver has been set incorrectly.	Refer to "PRECAUTIONS FOR COMMUNICATING WITH THE SERVO AMPLIFIER" on the "HELP" window in MR Configurator2.	
4. They are off-line.	Set them to on-line.	
5. There is a problem with the communication cable.	Replace the communication cable.	
6. The communication cable is not connected.	Connect the communication cable.	
7. Power is not being supplied to the servo amplifier.	Supply the power to the servo amplifier.	
8. The station number setting is incorrect.	Review the station number.	[A]

Electromagnetic brake went out

Possible cause	Check/action method	Model
1. The electromagnetic brake has reached the end of its service life.	Remove the servo motor and all the wiring from the machine, and check if the servo motor shaft is rotated by an external force. If the motor rotates, the brake has a failure. Replace the servo motor. Refer to "Characteristics of electromagnetic brake" in the following manual. Rotary Servo Motor User's Manual (For MR-J5)	[G] [B] [A]

Electromagnetic brake cannot be released

Possible cause	Check/action method	Model
1. The wiring is incorrect.	Check the output signals.	[G] [B] [A]
2. A signal of an output device has not been output correctly.	Check if the output device cable is wired correctly. Alternatively, check if the load of the output device is within specifications.	[G] [B] [A]

The vertical axis falls when the SBC output is used

Possible cause	Check/action method	Model
1. The STO function is used during servo-on, and the STO state is established.	For vertical axes, use the SS1 function, and establish the STO state.	[G]
2. A signal of an output device has not been output correctly.	Check if the output device cable is wired correctly. Check if the load of the output device is within specifications.	[G] [B] [A]
3. The waiting time for an electromagnetic brake sequence output has not been set correctly.	Review the settings of "electromagnetic brake sequence output" and "SS1/SS2 deceleration monitor time" with the following parameters. [G]: [Pr. PC02 Electromagnetic brake sequence output (MBR)] and [Pr. PSA03 SS1/SS2 deceleration monitor time (**SST)]	[G] [B] [A]

Coasting distance of the servo motor became longer

Possible cause	Check/action method	Model
1. The load increased and exceeded the permissible load to motor inertia.	Reduce the load.	[G] [B] [A]
2. The electromagnetic brake has reached the end of its service life.	Remove the servo motor and all the wiring from the machine, and check if the servo motor shaft can be rotated by the hands. If the motor rotates, the brake has a failure. Replace the servo motor. Refer to "Characteristics of electromagnetic brake" in the following manual. Rotary Servo Motor User's Manual (For MR-J5)	[G] [B] [A]
3. The electronic dynamic brake is disabled.	[G] [B]: Enable the electronic dynamic brake with [Pr. PF06.0 Electronic dynamic brake selection]. [A]: Enable the electronic dynamic brake with [Pr. PF09.0 Electronic dynamic brake selection].	[G] [B] [A]

Executed point table does not work

Possible cause	Check/action method	Model
1. Positioning to the same position are repeated.	Operation is repeatedly started by specifying the same point table number. Review the specification of the point table number or the operating procedure. Positioning to the same position address is repeated by selecting "8, 9, 10, 11" (continuous operation) in the auxiliary function of the point table. Review the setting value of the point table number or the operating procedure.	[G]
2. A point table number for which no value has been set is specified.	Set the correct value to the specified point table. Or, specify the point table number for which a value has been set.	

RS-422 communication (Mitsubishi Electric AC servo protocol) cannot be used

Possible cause	Check/action method	Model
1. The communication settings are incorrect.	Check that [Pr. PC20 Station No. setting] matches the station No. specified by the controller being used. Check that [Pr. PC21.1 RS-422 communication - Baud rate selection] matches the communication baud rate settings of the controller being used.	[A]
2. There is a problem with the communication cable.	Replace the communication cable.	
3. The wiring is incorrect.	Review the wiring.	

1.5 Two-digit display of alarm/warning number

For some objects, the alarm/warning number can only be read in two digits. For three-digit alarm/warning numbers, check the number using an object that can read three-digit numbers, the servo amplifier display, or MR Configurator2.

REVISIONS

*The manual number is given on the bottom left of the back cover.

Revision date	*Manual number	Description
June 2019	SH(NA)-030312ENG-A	First edition
January 2020	SH(NA)-030312ENG-B	■Alarms and warnings related to the following functions are added: Profile mode, communication function, fully closed loop system, scale measurement function, super trace control, touch probe, functional safety
July 2020	SH(NA)-030312ENG-C	■Alarms and warnings related to the following function are added: Functional safety
October 2020	SH(NA)-030312ENG-D	■Alarms and warnings related to the following functions are added: 400 V class servo amplifier, communication function (Mitsubishi Electric AC servo protocol), degree unit
March 2021	SH(NA)-030312ENG-E	■Alarms and warnings related to the following function are added: Positioning mode (point table method)
June 2021	SH(NA)-030312ENG-F	■Alarms and warnings related to the following functions are added: CC-Link IE Field Network Basic, MR-J5D_ drive unit
July 2022	SH(NA)-030312ENG-G	■The following model is added: MR-J5_-_B_ ■Alarms and warnings related to the following functions are added/edited: CC-Link IE TSN Class A, master-slave operation function
January 2023	SH(NA)-030312ENG-H	■Alarms and warnings related to the following function are added/edited: Servo motor incorrect wiring detection function
July 2023	SH(NA)-030312ENG-J	■The following alarms and warnings set by the manufacturer are added: [AL. 09E.B], [AL. 584], [AL. 585], [AL. 586], [AL. 587], [AL. 5E2.2], [AL. 5E2.A]
January 2024	SH(NA)-030312ENG-K	■Alarms and warnings related to the following functions are added: Functional safety, IP address setting function via the master station
July 2024	SH(NA)-030312ENG-L	■Alarms and warnings related to the following function are added/edited: Pressure mode
January 2025	SH(NA)-030312ENG-M	■Alarms and warnings related to the following function are added/edited: EtherNet/IP

This manual confers no industrial property rights or any rights of any other kind, nor does it confer any patent licenses. Mitsubishi Electric Corporation cannot be held responsible for any problems involving industrial property rights which may occur as a result of using the contents noted in this manual.

© 2019 MITSUBISHI ELECTRIC CORPORATION

WARRANTY

Warranty

1. Warranty period and coverage

We will repair any failure or defect hereinafter referred to as "failure" in our FA equipment hereinafter referred to as the "Product" arisen during warranty period at no charge due to causes for which we are responsible through the distributor from which you purchased the Product or our service provider. However, we will charge the actual cost of dispatching our engineer for an on-site repair work on request by customer in Japan or overseas countries. We are not responsible for any on-site readjustment and/or trial run that may be required after a defective unit are repaired or replaced.

[Term]

For terms of warranty, please contact your original place of purchase.

[Limitations]

(1) You are requested to conduct an initial failure diagnosis by yourself, as a general rule.

It can also be carried out by us or our service company upon your request and the actual cost will be charged. However, it will not be charged if we are responsible for the cause of the failure.

(2) This limited warranty applies only when the condition, method, environment, etc. of use are in compliance with the terms and conditions and instructions that are set forth in the instruction manual and user manual for the Product and the caution label affixed to the Product.

(3) Even during the term of warranty, the repair cost will be charged on you in the following cases;

1. a failure caused by your improper storing or handling, carelessness or negligence, etc., and a failure caused by your hardware or software problem
2. a failure caused by any alteration, etc. to the Product made on your side without our approval
3. a failure which may be regarded as avoidable, if your equipment in which the Product is incorporated is equipped with a safety device required by applicable laws and has any function or structure considered to be indispensable according to a common sense in the industry
4. a failure which may be regarded as avoidable if consumable parts designated in the instruction manual, etc. are duly maintained and replaced
5. any replacement of consumable parts (battery, fan, smoothing capacitor, etc.)
6. a failure caused by external factors such as inevitable accidents, including without limitation fire and abnormal fluctuation of voltage, and acts of God, including without limitation earthquake, lightning and natural disasters
7. a failure generated by an unforeseeable cause with a scientific technology that was not available at the time of the shipment of the Product from our company
8. any other failures which we are not responsible for or which you acknowledge we are not responsible for

2. Term of warranty after the stop of production

(1) We may accept the repair at charge for another seven (7) years after the production of the product is discontinued. The announcement of the stop of production for each model can be seen in our Sales and Service, etc.

(2) Please note that the Product (including its spare parts) cannot be ordered after its stop of production.

3. Service in overseas countries

Our regional FA Center in overseas countries will accept the repair work of the Product. However, the terms and conditions of the repair work may differ depending on each FA Center. Please ask your local FA center for details.

4. Exclusion of loss in opportunity and secondary loss from warranty liability

Regardless of the gratis warranty term, Mitsubishi shall not be liable for compensation to:

- (1) Damages caused by any cause found not to be the responsibility of Mitsubishi.
- (2) Loss in opportunity, lost profits incurred to the user by Failures of Mitsubishi products.
- (3) Special damages and secondary damages whether foreseeable or not, compensation for accidents, and compensation for damages to products other than Mitsubishi products.
- (4) Replacement by the user, maintenance of on-site equipment, start-up test run and other tasks.

5. Change of Product specifications

Specifications listed in our catalogs, manuals or technical documents may be changed without notice.

6. Application and use of the Product

(1) For the use of our AC Servo, its applications should be those that may not result in a serious damage even if any failure or malfunction occurs in AC Servo, and a backup or fail-safe function should operate on an external system to AC Servo when any failure or malfunction occurs.

(2) Our AC Servo is designed and manufactured as a general purpose product for use at general industries.

Therefore, applications substantially influential on the public interest for such as atomic power plants and other power plants of electric power companies, and also which require a special quality assurance system, including applications for railway companies and government or public offices are not recommended, and we assume no responsibility for any failure caused by these applications when used.

In addition, applications which may be substantially influential to human lives or properties for such as airlines, medical treatments, railway service, incineration and fuel systems, man-operated material handling equipment, entertainment machines, safety machines, etc. are not recommended, and we assume no responsibility for any failure caused by these applications when used.

We will review the acceptability of the abovementioned applications, if you agree not to require a specific quality for a specific application. Please contact us for consultation.

(3) Mitsubishi Electric shall have no responsibility or liability for any problems involving programmable controller trouble and system trouble caused by DoS attacks, unauthorized access, computer viruses, and other cyberattacks.

TRADEMARKS

MELSERVO is a trademark or registered trademark of Mitsubishi Electric Corporation in Japan and/or other countries. All other product names and company names are trademarks or registered trademarks of their respective companies.

SH(NA)-030312ENG-M(2501)MEE

MODEL:

MODEL CODE:

MITSUBISHI ELECTRIC CORPORATION

HEAD OFFICE: TOKYO BLDG., 2-7-3, MARUNOUCHI, CHIYODA-KU, TOKYO 100-8310, JAPAN
NAGOYA WORKS: 1-14, YADA-MINAMI 5-CHOME, HIGASHI-KU, NAGOYA 461-8670, JAPAN

When exported from Japan, this manual does not require application to the
Ministry of Economy, Trade and Industry for service transaction permission.

Specifications subject to change without notice.

Compliance with the indicated global standards and regulations is current as of the release date of this manual.