

Mitsubishi Electric AC Servo System

MITSUBISHI ELECTRIC SERVO SYSTEM
MELSERVo-*J5*

MR-J5-G/MR-J5W-G User's Manual (Parameters)



-MR-J5- _G_
-MR-J5W _ _G_
-MR-J5D _ _G_
-MR-J5- _G_ _N1
-MR-J5W _ _G_ _N1
-MR-J5D _ _G_ _N1

SAFETY INSTRUCTIONS

Please read the instructions carefully before using the equipment.

To use the equipment correctly, do not attempt to install, operate, maintain, or inspect the equipment until you have read through this manual, installation guide, and appended documents carefully. Do not use the equipment until you have a full knowledge of the equipment, safety information and instructions.





In this manual, the safety instruction levels are classified into "WARNING" and "CAUTION".

 WARNING	Indicates that incorrect handling may cause hazardous conditions, resulting in death or severe injury.
 CAUTION	Indicates that incorrect handling may cause hazardous conditions, resulting in medium or slight injury.

Note that the CAUTION level may lead to a serious consequence depending on conditions.

Please follow the instructions of both levels because they are important to personnel safety.

Forbidden actions and required actions are indicated by the following diagrammatic symbols.

	Indicates a forbidden action. For example, "No Fire" is indicated by  .
	Indicates a required action. For example, grounding is indicated by  .

In this manual, precautions for hazards that can lead to property damage, instructions for other functions, and other information are shown separately in the "Point" area.

After reading this manual, keep it accessible to the operator.

[Installation/wiring]

WARNING

- To prevent an electric shock, turn off the power and wait for 15 minutes or more (20 minutes or more for converter units/drive units) before starting wiring and/or inspection.
 - To prevent an electric shock, ground the servo amplifier.
 - To prevent an electric shock, any person who is involved in wiring should be fully competent to do the work.
 - To prevent an electric shock, mount the servo amplifier before wiring.
 - To prevent an electric shock, connect the protective earth (PE) terminal of the servo amplifier to the protective earth (PE) of the cabinet, then connect the grounding lead wire to the ground.
 - To prevent an electric shock, do not touch the conductive parts.
-

[Setting/adjustment]

WARNING

- To prevent an electric shock, do not operate the switches with wet hands.
-

[Operation]

WARNING

- To prevent an electric shock, do not operate the switches with wet hands.
-

[Maintenance]

WARNING

- To prevent an electric shock, any person who is involved in inspection should be fully competent to do the work.
 - To prevent an electric shock, do not operate the switches with wet hands.
-

ABOUT THE MANUAL

Point 

e-Manuals are Mitsubishi Electric FA electronic book manuals that can be browsed with a dedicated tool.

e-Manuals enable the following:

- Searching for desired information in multiple manuals at the same time (manual cross searching)
- Jumping from a link in a manual to another manual for reference
- Browsing for hardware specifications by scrolling over the components shown in product illustrations
- Bookmarking frequently referenced information
- Copying sample programs to engineering software

If using the servo for the first time, prepare and use the following related manuals to ensure that the servo is used safely. For the related manuals, refer to the User's Manual (Introduction).

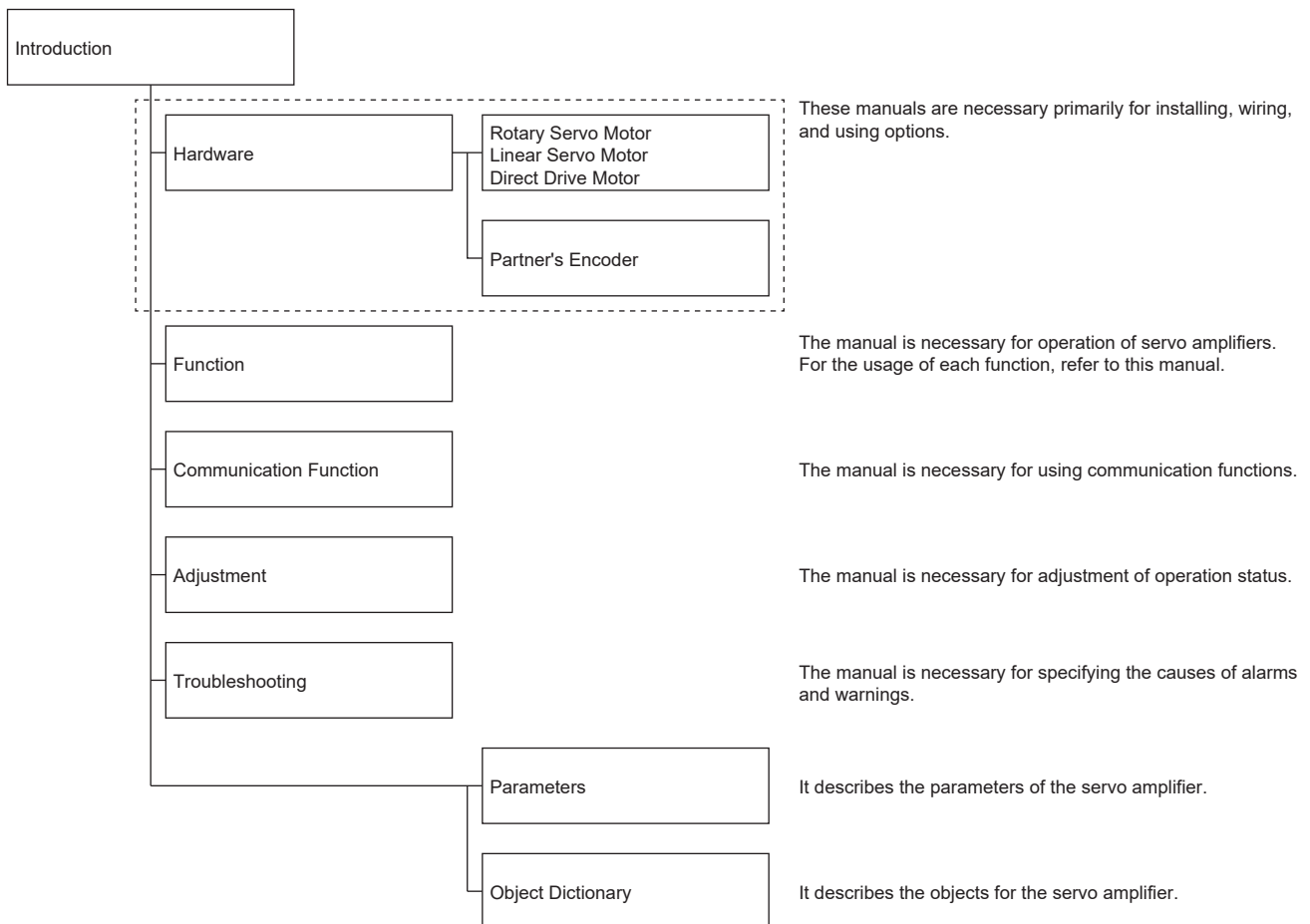

When reading this manual to use a drive unit, substitute "drive unit" for "servo amplifier".

Interpreting servo parameter numbers

For a servo parameter which uses one particular digit to select a function, the position of its digit indicates the detail number of the servo parameter, and the value in hexadecimal which is set to the digit indicates the selected function.

For example, the detail number of the servo parameter in the last digit is expressed as [Pr. PA01.0]. In addition, a servo parameter which uses a combination of several digits to select a function, is expressed using "-" as seen in [Pr. PA01.0-1]. The following is an example of the servo parameter number PA01 with the setting values of "FEDCBA98" in hexadecimal.

- When setting a servo parameter with one particular digit

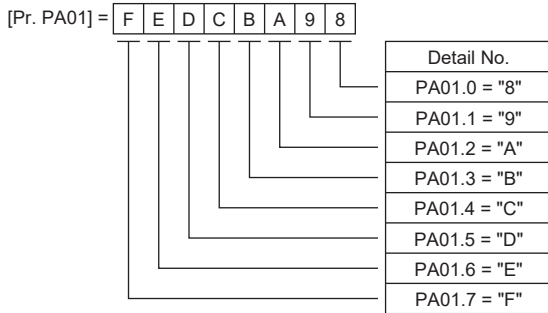

- When setting a servo parameter using a combination of several digits

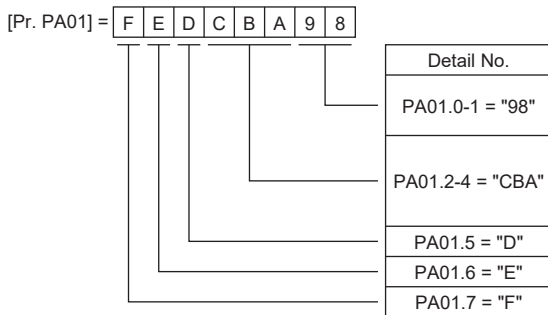

For example, if the servo parameter name is "Function selection A-1", the setting digit name is "Forced stop deceleration function selection", and the setting digit is the fourth last digit in PA04, the servo parameter is expressed as shown below.

[Pr. PA04.3 Forced stop deceleration function selection]

Servo parameter	Symbol	Name	Description
PA04.3	*AOP	Forced stop deceleration function selection	Set "Forced stop deceleration function" to enabled/disabled. Initial value: 1h (enabled)

Global standards and regulations

Compliance with the indicated global standards and regulations is current as of the release date of this manual. Some standards and regulations may have been modified or withdrawn.

DEFINITION OF TERMS IN COMMON BUS CONNECTION

The terms related to the construction of the common bus connection system are defined as follows:

Main unit: The servo amplifier connected to the 3-phase AC input power supply. It is the axis with the largest capacity in the servo system.

Sub unit: The servo amplifier not connected to the 3-phase AC input power supply. It is the axis powered by the bus of the main unit.

U.S. CUSTOMARY UNITS

U.S. customary units are not shown in this manual. Convert the values if necessary according to the following table.

Quantity	SI (metric) unit	U.S. customary unit
Mass	1 [kg]	2.2046 [lb]
Length	1 [mm]	0.03937 [inch]
Torque	1 [N•m]	141.6 [oz•inch]
Moment of inertia	1 [$\times 10^{-4}$ kg•m ²]	5.4675 [oz•inch ²]
Load (thrust load/axial load)	1 [N]	0.2248 [lbf]
Temperature	N [$^{\circ}$ C] \times 9/5 + 32	N [$^{\circ}$ F]

CONTENTS

SAFETY INSTRUCTIONS	1
ABOUT THE MANUAL	3
DEFINITION OF TERMS IN COMMON BUS CONNECTION	4
U.S. CUSTOMARY UNITS	5
CHAPTER 1 SERVO PARAMETER DETAILS	17
1.1 Explanation of servo parameters	18
1.2 Basic setting servo parameters group ([Pr. PA_ _])	19
[Pr. PA01_Operation mode (**STY)]	19
[Pr. PA02_Regenerative option (**REG)]	21
[Pr. PA03_Absolute position detection system (*ABS)]	23
[Pr. PA04_Function selection A-1 (*AOP1)]	25
[Pr. PA06_Electronic gear numerator (*CMX)]	25
[Pr. PA07_Electronic gear denominator (*CDV)]	25
[Pr. PA08_Auto tuning mode (ATU)]	26
[Pr. PA09_Auto tuning response (RSP)]	28
[Pr. PA10_In-position range (INP)]	29
[Pr. PA11_Forward rotation torque limit (TLP)]	29
[Pr. PA12_Reverse rotation torque limit (TLN)]	30
[Pr. PA14_Travel direction selection (*POL)]	31
[Pr. PA15_Encoder output pulses (*ENR)]	32
[Pr. PA16_Encoder output pulses 2 (*ENR2)]	32
[Pr. PA17_Servo motor series setting (**MSR)]	33
[Pr. PA18_Servo motor type setting (**MTY)]	34
[Pr. PA19_Servo parameter writing prohibited (*BLK)]	35
[Pr. PA20_Tough drive setting (*TDS)]	36
[Pr. PA21_Function selection A-3 (*AOP3)]	36
[Pr. PA22_Position control configuration selection (**PCS)]	37
[Pr. PA23_Drive recorder desired alarm trigger setting (DRAT)]	38
[Pr. PA24_Function selection A-4 (AOP4)]	39
[Pr. PA25_One-touch tuning - Overshoot permissible level (OTHOV)]	39
[Pr. PA26_Function selection A-5 (*AOP5)]	40
[Pr. PA28_Function selection A-6 (**AOP6)]	40
[Pr. PA34_Quick tuning - Permissible travel distance (QDIS)]	40
1.3 Gain/filter setting servo parameters group ([Pr. PB_ _])	41
[Pr. PB01_Adaptive tuning mode (adaptive filter II) (FILT)]	41
[Pr. PB02_Vibration suppression control tuning mode (advanced vibration suppression control II) (VRFT)]	42
[Pr. PB03_Torque feedback loop gain (TFBGN)]	42
[Pr. PB04_Feed forward gain (FFC)]	42
[Pr. PB06_Load to motor inertia ratio/load to motor mass ratio (GD2)]	43
[Pr. PB07_Model control gain (PG1)]	43
[Pr. PB08_Position control gain (PG2)]	44
[Pr. PB09_Speed control gain (VG2)]	44
[Pr. PB10_Speed integral compensation (VIC)]	44
[Pr. PB11_Speed differential compensation (VDC)]	45
[Pr. PB12_Overshoot amount compensation (OVA)]	45
[Pr. PB13_Machine resonance suppression filter 1 (NH1)]	45
[Pr. PB14_Notch shape selection 1 (NHQ1)]	46

[Pr. PB15_Machine resonance suppression filter 2 (NH2)]	46
[Pr. PB16_Notch shape selection 2 (NHQ2)]	47
[Pr. PB17_Shaft resonance suppression filter (NHF)]	48
[Pr. PB18_Low-pass filter setting (LPF)]	51
[Pr. PB19_Vibration suppression control 1 - Vibration frequency (VRF11)]	52
[Pr. PB20_Vibration suppression control 1 - Resonance frequency (VRF12)]	52
[Pr. PB21_Vibration suppression control 1 - Vibration frequency damping (VRF13)]	52
[Pr. PB22_Vibration suppression control 1 - Resonance frequency damping (VRF14)]	52
[Pr. PB23_Low-pass filter selection (VFBF)]	53
[Pr. PB24_Slight vibration suppression control (*MVS)]	54
[Pr. PB25_Function selection B-1 (*BOP1)]	54
[Pr. PB26_Gain switching function (*CDP)]	55
[Pr. PB27_Gain switching condition (CDL)]	57
[Pr. PB28_Gain switching time constant (CDT)]	57
[Pr. PB29_Gain switching - Load to motor inertia ratio/load to motor mass ratio (GD2B)]	57
[Pr. PB30_Gain switching - Position control gain (PG2B)]	57
[Pr. PB31_Gain switching - Speed control gain (VG2B)]	57
[Pr. PB32_Gain switching - Speed integral compensation (VICB)]	58
[Pr. PB33_Gain switching - Vibration suppression control 1 - Vibration frequency (VRF11B)]	58
[Pr. PB34_Gain switching - Vibration suppression control 1 - Resonance frequency (VRF12B)]	58
[Pr. PB35_Gain switching - Vibration suppression control 1 - Vibration frequency damping (VRF13B)]	58
[Pr. PB36_Gain switching - Vibration suppression control 1 - Resonance frequency damping (VRF14B)]	59
[Pr. PB45_Command notch filter (CNHF)]	59
[Pr. PB46_Machine resonance suppression filter 3 (NH3)]	62
[Pr. PB47_Notch shape selection 3 (NHQ3)]	63
[Pr. PB48_Machine resonance suppression filter 4 (NH4)]	63
[Pr. PB49_Notch shape selection 4 (NHQ4)]	64
[Pr. PB50_Machine resonance suppression filter 5 (NH5)]	64
[Pr. PB51_Notch shape selection 5 (NHQ5)]	65
[Pr. PB52_Vibration suppression control 2 - Vibration frequency (VRF21)]	65
[Pr. PB53_Vibration suppression control 2 - Resonance frequency (VRF22)]	66
[Pr. PB54_Vibration suppression control 2 - Vibration frequency damping (VRF23)]	66
[Pr. PB55_Vibration suppression control 2 - Resonance frequency damping (VRF24)]	66
[Pr. PB56_Gain switching - Vibration suppression control 2 - Vibration frequency (VRF21B)]	66
[Pr. PB57_Gain switching - Vibration suppression control 2 - Resonance frequency (VRF22B)]	67
[Pr. PB58_Gain switching - Vibration suppression control 2 - Vibration frequency damping (VRF23B)]	67
[Pr. PB59_Gain switching - Vibration suppression control 2 - Resonance frequency damping (VRF24B)]	67
[Pr. PB60_Gain switching - Model control gain (PG1B)]	67
[Pr. PB65_Gain switching 2 condition (CDL2)]	68
[Pr. PB66_Gain switching 2 time constant (CDT2)]	68
[Pr. PB67_Gain switching 2 - Load to motor inertia ratio/load to motor mass ratio (GD2C)]	68
[Pr. PB68_Gain switching 2 - Position control gain (PG2C)]	68
[Pr. PB69_Gain switching 2 - Speed control gain (VG2C)]	68
[Pr. PB70_Gain switching 2 - Speed integral compensation (VICC)]	69
[Pr. PB71_Gain switching 2 - Vibration suppression control 1 - Vibration frequency (VRF11C)]	69
[Pr. PB72_Gain switching 2 - Vibration suppression control 1 - Resonance frequency (VRF12C)]	69
[Pr. PB73_Gain switching 2 - Vibration suppression control 1 - Vibration frequency damping (VRF13C)]	70
[Pr. PB74_Gain switching 2 - Vibration suppression control 1 - Resonance frequency damping (VRF14C)]	70
[Pr. PB75_Gain switching 2 - Vibration suppression control 2 - Vibration frequency (VRF21C)]	70
[Pr. PB76_Gain switching 2 - Vibration suppression control 2 - Resonance frequency (VRF22C)]	71
[Pr. PB77_Gain switching 2 - Vibration suppression control 2 - Vibration frequency damping (VRF23C)]	71

	[Pr. PB78_Gain switching 2 - Vibration suppression control 2 - Resonance frequency damping (VRF24C)] . . .	71
	[Pr. PB79_Gain switching 2 - Model control gain (PG1C)]	72
	[Pr. PB81_Command filter (*CFIL)]	72
	[Pr. PB82_Position command smoothing filter time constant (PFT)]	72
1.4	Extension setting servo parameters group ([Pr. PC_ _])	73
	[Pr. PC01_Excessive error alarm trigger level (ERZ)]	73
	[Pr. PC02_Electromagnetic brake sequence output (MBR)]	73
	[Pr. PC03_Encoder output pulses selection (*ENRS)]	73
	[Pr. PC04_Function selection C-1 (**COP1)]	76
	[Pr. PC05_Function selection C-2 (**COP2)]	76
	[Pr. PC06_Function selection C-3 (*COP3)]	77
	[Pr. PC07_Zero speed (ZSP)]	77
	[Pr. PC08_Overspeed alarm detection level (OSL)]	77
	[Pr. PC09_Analog monitor 1 output (MOD1)]	78
	[Pr. PC10_Analog monitor 2 output (MOD2)]	79
	[Pr. PC11_Analog monitor 1 offset (MO1)]	79
	[Pr. PC12_Analog monitor 2 offset (MO2)]	79
	[Pr. PC16_Function selection C-3A (*COP3A)]	80
	[Pr. PC17_Function selection C-4 (**COP4)]	80
	[Pr. PC19_Function selection C-6 (*COP6)]	81
	[Pr. PC20_Function selection C-7 (*COP7)]	82
	[Pr. PC21_Alarm history clear (*BPS)]	83
	[Pr. PC24_Deceleration time constant at forced stop (RSBR)]	84
	[Pr. PC26_Function selection C-8 (**COP8)]	84
	[Pr. PC27_Function selection C-9 (**COP9)]	85
	[Pr. PC29_Function selection C-B (*COPB)]	86
	[Pr. PC31_Vertical axis freefall prevention compensation amount (RSUP1)]	88
	[Pr. PC38_Excessive error warning trigger level (ERW)]	88
	[Pr. PC41_Function selection C-J (*COPJ)]	89
	[Pr. PC42_Function selection C-10 (COP10)]	89
	[Pr. PC43_Forward rotation torque limit 2 (TLP2)]	90
	[Pr. PC44_Reverse rotation torque limit 2 (TLN2)]	90
	[Pr. PC46_Drive unit function selection 2 (*DUOP2)]	91
	[Pr. PC65_Zero speed 2 level (ZSP2L)]	92
	[Pr. PC66_Zero speed 2 filtering time (ZSP2F)]	92
	[Pr. PC67_Following error output level (FEW)]	92
	[Pr. PC69_Following error output filtering time (FEWF)]	93
	[Pr. PC70_In-position 2 - Output range (INP2R)]	93
	[Pr. PC71_In-position 2 - Output filtering time (INP2F)]	93
	[Pr. PC72_Speed reached 2 - Output range (SA2R)]	94
	[Pr. PC73_Speed reached 2 - Output filtering time (SA2F)]	94
	[Pr. PC76_Function selection C-E (*COPE)]	95
	[Pr. PC78_Function selection C-F (*COPF)]	95
	[Pr. PC79_Function selection C-G (*COPG)]	96
	[Pr. PC81_For manufacturer setting]	97
	[Pr. PC96_Output open-phase detection time (*OPDT)]	98
1.5	I/O setting servo parameters group ([Pr. PD_ _])	99
	[Pr. PD01_Input signal automatic ON selection 1 (*DIA1)]	99
	[Pr. PD03_Input device selection 1 (*DI1)]	100
	[Pr. PD04_Input device selection 2 (*DI2)]	101
	[Pr. PD05_Input device selection 3 (*DI3)]	102

	[Pr. PD07_Output device selection 1 (*DO1)]	104
	[Pr. PD08_Output device selection 2 (*DO2)]	106
	[Pr. PD09_Output device selection 3 (*DO3)]	107
	[Pr. PD11_Input filter setting (*DIF)]	108
	[Pr. PD12_Function selection D-1 (*DOP1)]	108
	[Pr. PD13_Function selection D-2 (*DOP2)]	109
	[Pr. PD14_Function selection D-3 (*DOP3)]	110
	[Pr. PD15_Driver communication setting (**IDCS)]	110
	[Pr. PD22_Driver communication setting - Slave - Master axis 1 - Station No. setting (*SM1N)]	111
	[Pr. PD23_Driver communication setting - Slave - Master axis 1 - Transmission and receive setting (*SM1C)]	111
	[Pr. PD26_Master-slave operation simultaneous stop function operation setting (*MSTO)]	112
	[Pr. PD30_Master-slave operation - Slave-side torque command coefficient (TLS)]	112
	[Pr. PD31_Master-slave operation - Slave-side speed limit coefficient (VLC)]	113
	[Pr. PD32_Master-slave operation - Slave-side speed limit adjusted value (VLL)]	113
	[Pr. PD38_Input device selection 4 (*DI4)]	114
	[Pr. PD39_Input device selection 5 (*DI5)]	115
	[Pr. PD41_Function selection D-4 (*DOP4)]	116
	[Pr. PD51_Input device selection 3-2 (*DI3W2)]	117
	[Pr. PD60_DI pin polarity selection (*DIP)]	118
	[Pr. PD61_Function selection D-5 (*DOP5)]	120
1.6	Extension setting 2 servo parameters group ([Pr. PE_ _])	121
	[Pr. PE01_Fully closed loop control function selection 1 (**FCT1)]	121
	[Pr. PE03_Fully closed loop control function selection 2 (*FCT2)]	122
	[Pr. PE04_Fully closed loop control - Feedback pulse electronic gear 1 - Numerator (**FBN)]	123
	[Pr. PE05_Fully closed loop control - Feedback pulse electronic gear 1 - Denominator (**FBD)]	123
	[Pr. PE06_Fully closed loop control - Speed deviation error detection level (BC1)]	123
	[Pr. PE07_Fully closed loop control - Position deviation error detection level (BC2)]	123
	[Pr. PE08_Fully closed loop dual feedback filter (DUF)]	123
	[Pr. PE10_Fully closed loop function selection 3 (FCT3)]	124
	[Pr. PE41_Function selection E-3 (EOP3)]	124
	[Pr. PE44_Lost motion compensation positive-side compensation value selection (LMCP)]	124
	[Pr. PE45_Lost motion compensation negative-side compensation value selection (LMCN)]	125
	[Pr. PE46_Lost motion filter setting (LMFLT)]	125
	[Pr. PE47_Unbalanced torque offset (TOF)]	125
	[Pr. PE48_Lost motion compensation function selection (*LMOP)]	125
	[Pr. PE49_Lost motion compensation timing (LMCD)]	126
	[Pr. PE50_Lost motion compensation dead band (LMCT)]	126
	[Pr. PE51_Load-side encoder resolution setting (**EDV2)]	126
	[Pr. PE53_Maximum torque limit 1 (TLMX1)]	127
1.7	Extension setting 3 servo parameters group ([Pr. PF_ _])	128
	[Pr. PF02_Function selection F-2 (*FOP2)]	128
	[Pr. PF06_Function selection F-5 (*FOP5)]	129
	[Pr. PF12_Electronic dynamic brake operating time (DBT)]	129
	[Pr. PF18_STO diagnosis error detection time (**STOD)]	130
	[Pr. PF19_Friction failure prediction - Compensation coefficient 1 (TSL)]	130
	[Pr. PF20_Friction failure prediction - Compensation coefficient 2 (TIC)]	131
	[Pr. PF21_Drive recorder switching time setting (DRT)]	131
	[Pr. PF23_Vibration tough drive - Oscillation detection level (OSCL1)]	131
	[Pr. PF24_Function selection F-9 (*FOP9)]	131

[Pr. PF25_SEMI-F47 function - Instantaneous power failure detection time (Instantaneous power failure tough drive detection time) (CVAT)]	132
[Pr. PF29_Function selection F-10 (*FOP10)]	132
[Pr. PF31_Machine diagnosis function - Friction estimate area judgment speed at low speed (FRIC)]	133
[Pr. PF32_Oscillation detection alarm time (*VIBT)]	133
[Pr. PF34_Machine diagnosis function selection (*MFP)]	134
[Pr. PF40_Machine failure prediction servo parameter (MFPP)]	136
[Pr. PF41_Failure prediction - Servo motor total travel distance (FPMT)]	137
[Pr. PF42_Friction failure prediction - Average characteristics (PAV)]	137
[Pr. PF43_Friction failure prediction - Standard deviation (PSD)]	137
[Pr. PF45_Vibration failure prediction - Average characteristics (VAV)]	137
[Pr. PF46_Vibration failure prediction - Standard deviation (VSD)]	138
[Pr. PF47_Servo motor total travel distance offset (TMO)]	138
[Pr. PF62_Function selection F-14 (FOP14)]	138
[Pr. PF63_Function selection F-15 (*FOP15)]	139
[Pr. PF66_Gear setting for backlash estimation (BLG)]	140
[Pr. PF67_Backlash nominal value (BLN)]	141
[Pr. PF68_Backlash threshold multiplication (BLTT)]	141
[Pr. PF69_Static friction failure prediction - Average characteristics (SPAV2)]	141
[Pr. PF70_Static friction failure prediction - Standard deviation (SPSD2)]	141
[Pr. PF71_Belt failure prediction function selection (BFP)]	142
[Pr. PF72_Belt tension on installation (SBT)]	142
[Pr. PF73_Belt tension when extended (ABT)]	142
[Pr. PF74_Static friction during installation (SSF)]	143
[Pr. PF75_Static friction when extended (ASF)]	143
[Pr. PF76_Belt tension irregular threshold (BTS)]	143
[Pr. PF80_Drive recorder - Operation condition selection (DRMC)]	144
[Pr. PF81_Drive recorder - Sampling operation selection (DRMS)]	145
[Pr. PF82_Drive recorder - Trigger operation selection (DRTM)]	146
[Pr. PF83_Drive recorder - Trigger operation axis common selection (**DRTAX)]	148
[Pr. PF84_Drive recorder - Trigger channel selection (DRTC)]	149
[Pr. PF85_Drive recorder - Trigger level setting 1 (DRTL1)]	150
[Pr. PF86_Drive recorder - Trigger level setting 2 (DRTL2)]	150
[Pr. PF87_Drive recorder - Analog channel setting 1 (DRAC1)]	151
[Pr. PF88_Drive recorder - Analog channel setting 2 (DRAC2)]	152
[Pr. PF89_Drive recorder - Analog channel setting 3 (DRAC3)]	153
[Pr. PF90_Drive recorder - Analog channel setting 4 (DRAC4)]	153
[Pr. PF91_Drive recorder - Digital channel setting 1 (DRDC1)]	154
[Pr. PF92_Drive recorder - Digital channel setting 2 (DRDC2)]	157
[Pr. PF93_Drive recorder - Digital channel setting 3 (DRDC3)]	157
[Pr. PF94_Drive recorder - Digital channel setting 4 (DRDC4)]	158
[Pr. PF95_Drive recorder - Clear history (**DRCLR)]	158
1.8 Motor extension setting servo parameters group ([Pr. PL_ _])	159
[Pr. PL01_Function selection L-1 (**LIT1)]	159
[Pr. PL02_Linear encoder resolution setting - Numerator (**LIM)]	159
[Pr. PL03_Linear encoder resolution setting - Denominator (**LID)]	160
[Pr. PL04_Function selection L-2 (*LIT2)]	160
[Pr. PL05_Position deviation error detection level (LB1)]	161
[Pr. PL06_Speed deviation error detection level (LB2)]	161
[Pr. PL07_Torque deviation error detection level (LB3)]	161
[Pr. PL08_Function selection L-3 (*LIT3)]	162

	[Pr. PL09_Magnetic pole detection voltage level (LPWM)]	162
	[Pr. PL17_Magnetic pole detection - Minute position detection method - Function selection (LTSTS)]	163
	[Pr. PL18_Magnetic pole detection - Minute position detection method - Identification signal amplitude (IDLV)]	164
1.9	Positioning control setting servo parameters group ([Pr. PT_ _])	165
	[Pr. PT01_Command mode selection (**CTY)]	165
	[Pr. PT02_Function selection T-1 (*TOP1)]	166
	[Pr. PT03_Feed function selection (*FTY)]	167
	[Pr. PT05_Homing speed (ZRF)]	167
	[Pr. PT06_Creep speed (CRF)]	168
	[Pr. PT07_Home position shift distance (ZST)]	168
	[Pr. PT08_Homing position data (ZPS)]	169
	[Pr. PT09_Travel distance after proximity dog (DCT)]	170
	[Pr. PT10_Stopper type homing - Stopping time (ZTM)]	170
	[Pr. PT11_Stopper type homing - Torque limit value (ZTT)]	170
	[Pr. PT12_Rough match output range (CRP)]	170
	[Pr. PT15_Software position limit + (LMP)]	171
	[Pr. PT17_Software position limit - (LMN)]	171
	[Pr. PT19_Position range output 1 address + (*LPP1)]	172
	[Pr. PT21_Position range output 1 address - (*LNP1)]	172
	[Pr. PT26_Function selection T-2 (*TOP2)]	173
	[Pr. PT29_Function selection T-3 (*TOP3)]	173
	[Pr. PT34_Positioning operation data default (**PDEF)]	174
	[Pr. PT38_Function selection T-7 (**TOP7)]	174
	[Pr. PT41_Function selection T-8 (TOP8)]	175
	[Pr. PT45_Homing method (HMM)]	175
	[Pr. PT49_Speed acceleration time constant (STA)]	180
	[Pr. PT50_Speed deceleration time constant (STB)]	180
	[Pr. PT51_S-pattern acceleration/deceleration time constants (STC)]	181
	[Pr. PT53_Torque slope (TQS)]	181
	[Pr. PT55_Function selection T-10 (*TOP10)]	182
	[Pr. PT56_Homing acceleration time constant (HMA)]	182
	[Pr. PT57_Homing deceleration time constant (HMB)]	182
	[Pr. PT65_Profile speed command (PVC)]	183
	[Pr. PT66_Maximum profile speed (MPVC)]	183
	[Pr. PT67_Speed limit (VLMT)]	183
	[Pr. PT68_Function selection T-11 (TOP11)]	184
	[Pr. PT83_Positioning function selection (*MOTOP)]	185
	[Pr. PT85_Function selection T-14 (*TOP14)]	185
1.10	Network setting servo parameters group ([Pr. PN_ _])	186
	[Pr. PN02_Communication error - Detection time (CERT)]	186
	[Pr. PN03_Communication mode setting (**NWMD)]	187
	[Pr. PN05_Communication error - Detection frequency setting (CERF)]	187
	[Pr. PN06_Function selection N-1 (NOP1)]	188
	[Pr. PN07_Communication cycle initial setting (**CCS)]	188
	[Pr. PN13_Network protocol setting (**NPS)]	189
	[Pr. PN18_Counter level for communication error detection (CERN)]	189
	[Pr. PN19_Function selection N-4 (**NOP4)]	189
	[Pr. PN20_Parameter automatic backup update interval (**PABI)]	191
	[Pr. PN22_Function selection N-5]	191
	[Pr. PN33_Device Warning Mask (DWM)]	192

[Pr. NPB21_Password No.6]	250
[Pr. NPB22_User name No.7]	251
[Pr. NPB23_Authorization level No.7]	251
[Pr. NPB24_Password No.7]	251
[Pr. NPB25_User name No.8]	251
[Pr. NPB26_Authorization level No.8]	251
[Pr. NPB27_Password No.8]	252
5.3 EtherNet/IP setting parameters	253
[Pr. NPC01_Configuration Control]	253
[Pr. NPC02_IP Address]	254
[Pr. NPC03_Network Mask]	255
[Pr. NPC04_Gateway Address]	256
[Pr. NPC05_Interface Control Port1]	257
[Pr. NPC06_Interface Control Port2]	257
CHAPTER 6 NETWORK PARAMETER SETTING METHOD	258
6.1 Engineering software	258
CHAPTER 7 FUNCTIONAL SAFETY PARAMETER DETAILS	260
7.1 Safety sub-function 1 parameters group ([Pr. PSA_ _])	261
[Pr. PSA01_Safety sub-function mode selection (**SOA)]	261
[Pr. PSA02_Functional safety setting (**SMD)]	261
[Pr. PSA03_SS1/SS2 deceleration monitor time (**SST)]	262
[Pr. PSA04_Safety sub-function - Stop speed (**SSS)]	263
[Pr. PSA05_SOS permissible travel distance (**SSDP)]	263
[Pr. PSA06_SOS permissible travel distance unit selection (**SAOP1)]	263
[Pr. PSA07_SLS deceleration monitor time 1 (**SLSDT1)]	264
[Pr. PSA08_SLS deceleration monitor time 2 (**SLSDT2)]	264
[Pr. PSA09_SLS deceleration monitor time 3 (**SLSDT3)]	264
[Pr. PSA10_SLS deceleration monitor time 4 (**SLSDT4)]	264
[Pr. PSA11_SLS speed 1 (**SLSS1)]	265
[Pr. PSA12_SLS speed 2 (**SLSS2)]	265
[Pr. PSA13_SLS speed 3 (**SLSS3)]	265
[Pr. PSA14_SLS speed 4 (**SLSS4)]	265
[Pr. PSA15_Safety sub-function - Speed detection delay time (**SLST)]	266
[Pr. PSA17_Safety sub-function - Position detection delay time (**SOSPT)]	266
[Pr. PSA18_SSM speed (**SSMS)]	266
[Pr. PSA19_SSM hysteresis width (**SSMHW)]	267
[Pr. PSA20_Servo motor encoder resolution (**SMER)]	267
[Pr. PSA22_Position feedback error detection time (**SAADT)]	267
[Pr. PSA23_Servo motor rated speed (**SMRS)]	267
[Pr. PSA24_SS1/SS2 deceleration monitor time constant (**SSTC)]	267
[Pr. PSA25_SS1/SS2 deceleration monitor speed offset (**SSOF)]	268
[Pr. PSA26_SS1/SS2 deceleration monitor delay time (**SSDT)]	268
[Pr. PSA27_SDI positive direction monitor delay time (**SDIDTP)]	268
[Pr. PSA28_SDI negative direction monitor delay time (**SDIDTN)]	268
7.2 Safety sub-function 2 parameters group ([Pr. PSB_ _])	269
[Pr. PSB01_SLI permissible travel distance - Unit selection (**SLIPUS)]	269
[Pr. PSB02_SLI permissible travel distance - Positive direction 1 (**SLIPP1)]	269
[Pr. PSB06_SLI permissible travel distance - Negative direction 1 (**SLIPN1)]	269

	[Pr. PSB10_SLT torque upper limit value 1 (**SLTP1)]	270
	[Pr. PSB11_SLT torque upper limit value 2 (**SLTP2)]	270
	[Pr. PSB12_SLT torque upper limit value 3 (**SLTP3)]	270
	[Pr. PSB13_SLT torque upper limit value 4 (**SLTP4)]	270
	[Pr. PSB14_SLT torque lower limit value 1 (**SLTN1)]	271
	[Pr. PSB15_SLT torque lower limit value 2 (**SLTN2)]	271
	[Pr. PSB16_SLT torque lower limit value 3 (**SLTN3)]	271
	[Pr. PSB17_SLT torque lower limit value 4 (**SLTN4)]	271
	[Pr. PSB18_SLT torque detection delay time (**SLTT)]	272
7.3	Network parameters group ([Pr. PSC_ _])	273
	[Pr. PSC01_Transmission interval monitor time (**SNC)]	273
	[Pr. PSC03_Functional safety - Rotation direction selection/travel direction selection (**SNPOL)]	273
	[Pr. PSC05_Safety communication - Function setting (**SCFS)]	273
	[Pr. PSC06_Safety verification code (**SAC)]	274
	[Pr. PSC07_FSoE Address setting (**FSADD)]	274
	[Pr. PSC08_Safety communication - Functional safety disabled setting (**SCFN)]	275
	[Pr. PSC09_Safety communication - Output signal polarity setting (**SFPOL)]	277
7.4	Safety I/O device parameters group ([Pr. PSD_ _])	279
	[Pr. PSD01_Input device automatic activation selection (**SDIA)]	279
	[Pr. PSD02_Safety input device selection DI1 (**SDI1)]	280
	[Pr. PSD03_Safety input device selection DI2 (**SDI2)]	282
	[Pr. PSD04_Safety input device selection DI3 (**SDI3)]	282
	[Pr. PSD08_Safety output device selection DO1 (**SDO1)]	283
	[Pr. PSD09_Safety output device selection DO2 (**SDO2)]	284
	[Pr. PSD10_Safety output device selection DO3 (**SDO3)]	285
	[Pr. PSD12_Input device - Noise elimination filter time DI1 (**SDIF1)]	286
	[Pr. PSD13_Input device - Noise elimination filter time DI2 (**SDIF2)]	287
	[Pr. PSD14_Input device - Noise elimination filter time DI3 (**SDIF3)]	287
	[Pr. PSD18_Permissible time for mismatches DI1 (**SDIDT1)]	287
	[Pr. PSD19_Permissible time for mismatches DI2 (**SDIDT2)]	288
	[Pr. PSD20_Permissible time for mismatches DI3 (**SDIDT3)]	288
	[Pr. PSD24_Input device - Test pulse diagnosis execution selection 1 (**SDIP1)]	289
	[Pr. PSD26_Input device - Test pulse off time 1 (**SDIPW)]	289
	[Pr. PSD27_Input device - Fixing diagnosis at startup execution selection 1 (**SDID1)]	290
	[Pr. PSD29_Output device - Test pulse diagnosis execution selection (**SDOP)]	291
	[Pr. PSD30_Output device - Test pulse off time (**SDOPW)]	292
	[Pr. PSD31_Output device - Feedback diagnosis execution selection (**SDOD1)]	293
7.5	Extension setting 3 parameters group ([Pr. PSL_ _])	294
	[Pr. PSL02_Functional safety - Linear encoder resolution setting - Numerator (**SLIM)]	294
	[Pr. PSL03_Functional safety - Linear encoder resolution setting - Denominator (**SLID)]	294
CHAPTER 8 LISTS OF FUNCTIONAL SAFETY PARAMETER INITIAL VALUES		295
8.1	Safety sub-function 1 parameters group ([Pr. PSA_ _])	295
8.2	Safety sub-function 2 parameters group ([Pr. PSB_ _])	297
8.3	Network parameters group ([Pr. PSC_ _])	299
8.4	Safety I/O device parameters group ([Pr. PSD_ _])	300
8.5	Extension setting 3 parameters group ([Pr. PSL_ _])	302
CHAPTER 9 FUNCTIONAL SAFETY PARAMETER SETTING METHOD		304
9.1	Engineering software	304

REVISIONS	306
WARRANTY	307
TRADEMARKS	308

1 SERVO PARAMETER DETAILS

Restrictions

Settable servo parameters and values depend on the controller model, servo amplifier firmware version, and MR Configurator2 software version. For details, refer to the controller user's manual. Refer to the Mitsubishi Electric FA site for the latest software version of MR Configurator2. In addition, the firmware version of the servo amplifier can be checked with MR Configurator2, objects, or by other means.

When using servo motors with functional safety, executing software reset may trigger [AL. 016 Encoder initial communication error 1]. If [AL. 016] occurs, cycle the power.

Precautions

Never make a drastic adjustment or change to the servo parameter values as doing so will make the operation unstable. Do not change the servo parameter settings as described below. Doing so may cause an unexpected condition, such as failing to start up the servo amplifier.

- Changing the values of the servo parameters for manufacturer setting
- Setting a value outside the range
- Changing the fixed value in each servo parameter

When writing servo parameters with the controller, make sure that the control axis No. of the servo amplifier is set correctly. Failure to do so may cause the servo parameter settings of another axis to be written and result in the servo amplifier being in an unexpected condition.

Some servo parameters are adjusted automatically. For example, auto tuning automatically adjusts gain servo parameters. Some servo parameters correspond to the objects that can be updated periodically in cyclic communication. For example, [Pr. PT45 Homing method] corresponds to [Homing method (Obj. 6098h)]. When a relevant object is mapped in cyclic communication, the controller overwrites the servo parameter value written with engineering software. Thus, do not write a value with engineering software.

1.1 Explanation of servo parameters

For how to interpret the servo parameter numbers, refer to the following.

☞ Page 4 Interpreting servo parameter numbers

The following explains how to read the details of servo parameters.

Item	Explanation
No.	Indicates the servo parameter No., which can be identified by the servo parameter group and number.
Symbol	Indicates the abbreviation of the servo parameter. *** added to abbreviations means the following. *: After setting, cycle the power, or reset either the controller or the software. **: After setting, cycle the power or reset the software.
Name	Indicates the name of the servo parameter.
Initial value (unit)	Indicates the servo parameter initial value at factory setting. When there is a unit in the servo parameter, the unit is shown with [].
Setting range	Indicates the setting range of the servo parameter.
Setting method	For multi axis servo amplifiers, "Common" means that the same setting is applied to each axis. "Each axis" means that the setting for each axis is different. The latest setting value for "Common" is applied to all axes.
Ver.	Indicates the supported firmware version of the servo amplifier. The servo parameter is available on servo amplifiers with the firmware version or later.
TSN	Indicates CC-Link IE TSN.
ECT	Indicates EtherCAT.
EIP	Indicates EtherNet/IP.
J5G	Indicates the MR-J5-_G(4)/MR-J5-_G(4)-RJ/MR-J5-_G(4)-HS/MR-J5-_G(4)-LL/MR-J5W_-_G.
J5G-N1	Indicates the MR-J5-_G(4)-N1/MR-J5-_G(4)-RJN1/MR-J5-_G(4)-HSN1/MR-J5W_-_G-N1.

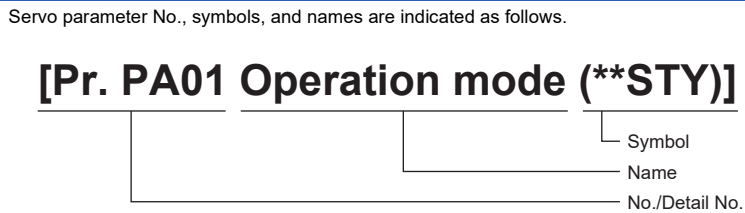

1.2 Basic setting servo parameters group ([Pr. PA_ _])

[Pr. PA01_Operation mode (**STY)]

Initial value	Setting range	Setting method	Ver.
00003000h	Refer to the relevant detail No.	Each axis	Refer to the relevant detail No.

[Pr. PA01.0_Control mode selection]

Initial value	Setting range	Ver.
0h	Refer to the text	B8

Select a control mode.

0: Network standard mode

6: Positioning mode (point table method)

The control modes that can be used for each network are as follows.

Command interface	Network	Supported control mode	
		[Pr. PA01.0] = "0"	[Pr. PA01.0] = "6"
CC-Link IE TSN	0000h (CC-Link IE TSN)	csp/csv/cst/pp/pv/tq/hm/ct/slt/cspr	pt/jg/hm
CC-Link IE Field Network Basic	0004h (CC-Link IE Field Network Basic)	pp/pv/tq/hm	pt/jg/hm
EtherCAT	0100h (EtherCAT)	csp/csv/cst/pp/pv/tq/hm	pt/jg/hm
EtherNet/IP	0800h (EtherNet/IP)	pp/pv/tq/hm	pt/jg/hm

*1 Available on servo amplifiers with firmware version C0 or later.

Setting a value other than "0" and "6" triggers [AL. 037 Parameter error].

When the command interface of the servo amplifier is EtherNet/IP, setting a value other than "0" triggers [AL. 037 Parameter error].

[Pr. PA01.1_Operation mode selection]

Initial value	Setting range	Ver.
0h	Refer to the text	A0

0: Standard control mode

4: Linear servo motor control mode

6: Direct drive motor control mode

[Pr. PA01.4_Fully closed loop operation mode selection]

Initial value	Setting range	Ver.
0h	Refer to the text	A5

Select whether to enable or disable the fully closed loop control mode.

The external encoder communication method of four-wire type cannot be used in the fully closed loop control mode on the MR-J5-_G_. Use the MR-J5-_G_-RJ_ or MR-J5-_G_-HS_.

When this servo parameter is set to "1" in the linear servo motor control mode, [AL. 037 Parameter error] occurs.

Setting "1" (enabled) on the MR-J5W3-_G_ or MR-J5D3-_G_ triggers [AL. 037].

0: Disabled (semi closed loop control mode)

1: Enabled (fully closed loop control mode)

This servo parameter is not available for the MR-J5-_G_-LL servo amplifier.

[Pr. PA01.7_High-speed mode selection]

When the command interface of the servo amplifier is EtherCAT, this servo parameter is not available.

Initial value	Setting range	Ver.
0h	Refer to the text	A6

When a communication cycle is set to 31.25 μ s in CC-Link IE TSN, set "1" (enabled).

Setting "1" on the MR-J5W_-_G triggers [AL. 037 Parameter error].

0: Disabled

1: Enabled

When this servo parameter is set to "1" and other servo parameters are set as follows, [AL. 037 Parameter error] occurs.

- [Pr. PA01.0 Control mode selection] = "6" (positioning mode (point table method))
- [Pr. PA01.4 Fully closed loop operation mode selection] = "1" (enabled (fully closed loop control mode))
- [Pr. PA22.3 Scale measurement function selection] = "1" (use with absolute position detection system)
- [Pr. PA22.3 Scale measurement function selection] = "2" (use with incremental system)
- [Pr. PT01.1 Speed/acceleration/deceleration unit selection] = "1" (command unit/s)
- [Pr. PT01.2 Unit for position data] = "2" (degree)
- [Pr. PT02.7 Internal position command - Process speed selection] = "1" (high-speed)
- [Pr. PD15.0 Master axis operation selection] = "1" (enabled (set this servo amplifier for the master axis.))
- [Pr. PD15.1 Slave axis operation selection] = "1" (enabled (set this servo amplifier for the slave axis.))
- [Pr. PN03.1 CC-Link IE TSN Class setting] = "1" (Class A ver. 2.0)

When this servo parameter is set to "1" and the control mode is set to the profile position mode (pp), profile velocity mode (pv), or profile torque mode (tq), [AL. 19E Network warning 2] occurs.

This servo parameter is not available for the MR-J5-_G_-LL servo amplifier.

[Pr. PA02_Regenerative option (**REG)]

Initial value	Setting range	Setting method	Ver.
00000000h	Refer to the relevant detail No.	Common	Refer to the relevant detail No.

[Pr. PA02.0-1_Regenerative option selection]

Initial value	Setting range	Ver.
00h	Refer to the text	A0

Select a regenerative option.

Incorrect setting may cause the regenerative option to burn.

If a selected regenerative option is not for use with the servo amplifier, [AL. 037 Parameter error] occurs.

When the FR-XC(-H) or FR-BU2(-H) is used, other regenerative options cannot be used simultaneously.

When constructing a common bus connection using a servo amplifier with a capacity of 12 kW to 25 kW as the main unit, refer to "Common bus connection system using an MR-J5 servo amplifier with a capacity of 12 kW or more as the main unit" in the User's Manual (Hardware).

The setting value of this servo parameter is disabled for the MR-J5D _ _ G _.

00: Regenerative option is not used.

- No regenerative resistors are used on servo amplifiers with a capacity of 100 W.
- Built-in regenerative resistors are used on servo amplifiers with a capacity of 0.2 kW to 7 kW.
- The supplied regenerative resistors or regenerative options are used on servo amplifiers with a capacity of 12 kW to 25 kW.

01: FR-XC(-H)/servo amplifier sub unit (in the common bus connection)

- When using the servo amplifier as the main unit, do not set this parameter to "01".
- When using the FR-BU2(-H), set this parameter to "01".

02: MR-RB032

03: MR-RB12

05: MR-RB30

06: MR-RB50 (A cooling fan is required.)

08: MR-RB31

09: MR-RB51 (A cooling fan is required.)

0B: MR-RB3N

0C: MR-RB5N (A cooling fan is required.)

0D: MR-RB14

0E: MR-RB34

1C: MR-RB3Z

1D: MR-RB5Z (A cooling fan is required.)

80: MR-RB1H-4

81: MR-RB3M-4 (A cooling fan is required.)

82: MR-RB3G-4 (A cooling fan is required.)

83: MR-RB5G-4 (A cooling fan is required.)

84: MR-RB34-4 (A cooling fan is required.)

85: MR-RB54-4 (A cooling fan is required.)

91: MR-RB3U-4 (A cooling fan is required.)

92: MR-RB5U-4 (A cooling fan is required.)

93: MR-RB3Y-4 (A cooling fan is required.)

94: MR-RB5Y-4 (A cooling fan is required.)

FA: The capacity of the regenerative resistors or regenerative options is increased (A cooling fan is used).

- The setting is available only on servo amplifiers with a capacity of 12 kW to 25 kW.

"1C" and "1D" are available on servo amplifiers with firmware version B6 or later.

"84", "85", "91", and "92" are available on servo amplifiers with firmware version E0 or later.

"FA" is available on servo amplifiers with firmware version E8 or later.

[Pr. PA02.4_Simple converter selection]

Initial value	Setting range	Ver.
0h	Refer to the text	A0

When using the simple converter, set this servo parameter.

The simple converter and external regenerative option can be used together. When using an external regenerative option, set the regenerative option to be used with [Pr. PA02.0-1].

When [Pr. PA02.0-1 Regenerative option selection] is set to "01" (FR-XC-(H)), setting this servo parameter to "1" (MR-CM3K) triggers [AL. 037 Parameter error].

The setting value of this servo parameter is disabled for the MR-J5D_-_G_.

0: Simple converter is not used

1: MR-CM3K

[Pr. PA02.5_Excessive regeneration warning enabled/disabled selection]

Initial value	Setting range	Ver.
0h	Refer to the text	A0

When [Pr. PA02.4] is set to "0" (simple converter is not used), setting this servo parameter to "1" (disabled) triggers [AL. 037 Parameter error].

When the simple converter is used, whether to enable or disable the detection of [AL. 0E0.1 Excessive regeneration warning] is selectable with this servo parameter.

0: Enabled

1: Disabled

[Pr. PA03_Absolute position detection system (*ABS)]

Initial value	Setting range	Setting method	Ver.
00000000h	Refer to the relevant detail No.	Each axis	Refer to the relevant detail No.

[Pr. PA03.0_Absolute position detection system selection]

Initial value	Setting range	Ver.
0h	Refer to the text	A0

Set this servo parameter when using the absolute position detection system. If the absolute position detection system is switched to the incremental system, the home position is erased. Execute homing again when the absolute position detection system is enabled.

0: Disabled (incremental system)

1: Enabled (absolute position detection system)

In the following case, enabling the absolute position detection system triggers [AL. 037 Parameter error].

- When an incremental type encoder is being used
- When semi closed/fully closed switching is enabled

By setting [Pr. PF63.0 [AL. 01A.5 Servo motor combination error 3] selection] to "1" (disabled) while the absolute position detection system is enabled, an in-use servo motor with a batteryless absolute position encoder can be replaced without changing the setting value of [Pr. PA03.1 Servo motor replacement preparation].

Connecting a servo motor that had not been connected at the startup of the absolute position detection system will cause [AL. 025 Absolute position erased], erasing absolute position data.

Therefore, check if a correct servo motor is connected.

[Pr. PA03.1_Servo motor replacement preparation]

Initial value	Setting range	Ver.
0h	Refer to the text	A0

To replace an in-use batteryless absolute position encoder equipped servo motor while the absolute position detection system is in enabled status, set this servo parameter to "enabled".

Selecting "1" (enabled) enables servo motor replacement. After completing the servo motor replacement preparation, the value automatically changes to "0" (disabled) and the home position is erased.

After replacing the servo motor, execute homing again.

If [AL. 01A.5 Servo motor combination error 3] occurs after servo motor replacement, set this servo parameter to "1" (enabled), cycle the power, and then deactivate [AL. 01A.5].

0: Disabled

1: Enabled

To set this servo parameter to "1" (enabled), refer to "Procedure of replacing a servo motor with battery-less absolute position encoder " in User's Manual (Hardware).

[Pr. PA03.2_Scale measurement encoder replacement preparation]

Initial value	Setting range	Ver.
0h	Refer to the text	A5

To replace an in-use batteryless absolute position scale measurement encoder while the absolute position detection system is in enabled status, set this servo parameter to "enabled".

Selecting "1" (enabled) enables scale measurement encoder replacement. After completing the scale measurement encoder replacement preparation, the value automatically changes to "0" (disabled) and the home position is erased.

After replacing the scale measurement encoder, execute homing again.

After setting this servo parameter to "enabled", cycle the power and then deactivate [AL. 01A.6 Servo motor combination error 4].

0: Disabled

1: Enabled

To set this servo parameter to "1" (enabled), refer to "Procedure for replacing the scale measurement encoder (Mitsubishi Electric servo motor equipped with a batteryless absolute position encoder)" in User's Manual (Function).

This servo parameter is not available for the MR-J5-_G_-LL servo amplifier.

[Pr. PA04_Function selection A-1 (*AOP1)]

Initial value	Setting range	Setting method	Ver.
00002000h	Refer to the relevant detail No.	Common	Refer to the relevant detail No.

[Pr. PA04.2_Servo forced stop selection]

Initial value	Setting range	Ver.
0h	Refer to the text	A0

0: Enabled (the forced stop input EM2 or EM1 is used)

1: Disabled (the forced stop input EM2 and EM1 are not used)

[Pr. PA04.3_Forced stop deceleration function selection]

Initial value	Setting range	Ver.
2h	Refer to the text	A0

0: Forced stop deceleration function disabled (EM1 is used)

2: Forced stop deceleration function enabled (EM2 is used)

[Pr. PA06_Electronic gear numerator (*CMX)]

Initial value	Setting range	Setting method	Ver.
1	1 to 2147483647	Each axis	A0

Set the electronic gear numerator.

This servo parameter corresponds to [Motor revolutions (Obj. 6091h: 01h)]. When an object is mapped in cyclic communication, the controller overwrites the value written with engineering software. Thus, do not write a value with engineering software.

If the electronic gear is set to a value outside the setting range, noise may be generated during acceleration/deceleration, or operation may not be performed at the preset speed and/or acceleration/deceleration time constants.

The setting range of the electronic gear ([Pr. PA06]/[Pr. PA07 Electronic gear denominator]) is as follows.

Encoder resolution [pulse]	Setting range (CMX/CDV)
67108864	1/16 to 8388608

When [Pr. PT01.2 Unit for position data] is set to "2" (degree), the following two conditions must be met as well:

- When the electronic gear (CMX/CDV) is reduced to the lowest terms, its numerator and denominator are 16384 (2^{14}) or less.
- When $(CMX \times \text{encoder resolution [pulse]}) / (CDV \times 360000)$ is reduced to the lowest terms, its numerator and denominator are 2147483647 ($2^{31}-1$) or less.

[Pr. PA07_Electronic gear denominator (*CDV)]

Initial value	Setting range	Setting method	Ver.
1	1 to 2147483647	Each axis	A0

Set the electronic gear denominator.

Refer to the condition range of [Pr. PA06 Electronic gear numerator] for the electronic gear settings.

☞ Page 25 [Pr. PA06_Electronic gear numerator (*CMX)]

This servo parameter corresponds to [Shaft revolutions (Obj. 6091h: 02h)]. When an object is mapped in cyclic communication, the controller overwrites the value written with engineering software. Thus, do not write a value with engineering software.

[Pr. PA08_Auto tuning mode (ATU)]

Initial value	Setting range	Setting method	Ver.
00000001h	Refer to the relevant detail No.	Each axis	Refer to the relevant detail No.

[Pr. PA08.0_Gain adjustment mode selection]

Initial value	Setting range	Ver.
1h	Refer to the text	A0

Select the gain adjustment mode.

0: 2 gain adjustment mode 1 (interpolation mode)

1: Auto tuning mode 1

2: Auto tuning mode 2

3: Manual mode

4: 2 gain adjustment mode 2

5: Quick tuning mode

6: Load to motor inertia ratio monitor mode

Refer to the following table for details.

Setting value of [Pr. PA08.0]	Gain adjustment mode	Servo parameter adjusted automatically
0	2 gain adjustment mode 1 (interpolation mode)	[Pr. PB06 Load to motor inertia ratio/load to motor mass ratio] [Pr. PB08 Position control gain] [Pr. PB09 Speed control gain] [Pr. PB10 Speed integral compensation]
1	Auto tuning mode 1	[Pr. PB06 Load to motor inertia ratio/load to motor mass ratio] [Pr. PB07 Model control gain] [Pr. PB08 Position control gain] [Pr. PB09 Speed control gain] [Pr. PB10 Speed integral compensation]
2	Auto tuning mode 2	[Pr. PB07 Model control gain] [Pr. PB08 Position control gain] [Pr. PB09 Speed control gain] [Pr. PB10 Speed integral compensation]
3	Manual mode	—
4	2 gain adjustment mode 2	[Pr. PB08 Position control gain] [Pr. PB09 Speed control gain] [Pr. PB10 Speed integral compensation]
5	Quick tuning mode	[Pr. PB07 Model control gain] [Pr. PB08 Position control gain] [Pr. PB09 Speed control gain] [Pr. PB10 Speed integral compensation] [Pr. PB13 Machine resonance suppression filter 1] [Pr. PB14 Notch shape selection 1] [Pr. PB15 Machine resonance suppression filter 2] [Pr. PB16 Notch shape selection 2] [Pr. PB18 Low-pass filter setting] [Pr. PB23 Low-pass filter selection] [Pr. PB50 Machine resonance suppression filter 5] [Pr. PB51 Notch shape selection 5] [Pr. PE41 Function selection E-3]
6	Load to motor inertia ratio monitor mode	[Pr. PB06 Load to motor inertia ratio/load to motor mass ratio]

[Pr. PA08.4_Quick tuning - Load to motor inertia ratio setting]

Initial value	Setting range	Ver.
0h	Refer to the text	A0

Set the load to motor inertia ratio at quick tuning. If the load connected to the servo motor is larger than the load to motor inertia ratio set in the servo parameter, an overshoot may occur in positioning operation after quick tuning.

0: Load to motor inertia ratio of 30 times or less

1: Load to motor inertia ratio of 100 times or less

[Pr. PA08.5_Quick tuning - Execution selection]

Initial value	Setting range	Ver.
0h	Refer to the text	A0

Set when to execute quick tuning.

0: At initial servo-on after cycling the power

1: At every servo-on

[Pr. PA08.6_Quick tuning - Restore selection]

Initial value	Setting range	Ver.
0h	Refer to the text	A0

Set whether to return servo parameters to the values from before quick tuning.

0: Disabled

1: Enabled

By setting "1" (enabled), the following servo parameters return to the values from before quick tuning. If quick tuning has never been performed after power on or software reset, setting "1" (enabled) only keeps the current servo parameter values.

No.	Symbol	Name
PB01	FILT	Adaptive tuning mode (adaptive filter II)
PB07	PG1	Model control gain
PB08	PG2	Position control gain
PB09	VG2	Speed control gain
PB10	VIC	Speed integral compensation
PB11	VDC	Speed differential compensation
PB13	NH1	Machine resonance suppression filter 1
PB14	NHQ1	Notch shape selection 1
PB15	NH2	Machine resonance suppression filter 2
PB16	NHQ2	Notch shape selection 2
PB18	LPF	Low-pass filter setting
PB23	VFBF	Low-pass filter selection
PB50	NH5	Machine resonance suppression filter 5
PB51	NHQ5	Notch shape selection 5
PE41	EOP3	Function selection E-3

[Pr. PA09_Auto tuning response (RSP)]

Initial value	Setting range	Setting method	Ver.
16	Refer to the text	Each axis	A0

Set the auto tuning response.

Setting value	Machine characteristic	
	Responsiveness	Guideline for machine resonance frequency [Hz]
1	<p>Low response</p> <p>Middle response</p> <p>High response</p>	2.7
2		3.6
3		4.9
4		6.6
5		10.0
6		11.3
7		12.7
8		14.3
9		16.1
10		18.1
11		20.4
12		23.0
13		25.9
14		29.2
15		32.9
16		37.0
17		41.7
18		47.0
19		52.9
20		59.6
21		67.1
22		75.6
23		85.2
24		95.9
25		108.0
26		121.7
27		137.1
28		154.4
29		173.9
30		195.9
31		220.6
32		248.5
33		279.9
34		315.3
35		355.1
36		400.0
37		446.6
38		501.2
39		571.5
40		642.7

[Pr. PA10_In-position range (INP)]

Initial value	Setting range	Setting method	Ver.
25600 [Refer to the text below for the unit.]	0 to 16777215	Each axis	A0

Set the in-position range in the command pulse unit.

With the setting of [Pr. PC06.0 In-position range unit selection], the unit can be changed to the servo motor encoder pulse unit.

- In-position range setting

Control mode	In-position setting range
Profile mode/Cyclic synchronous mode	Range where in-position (INP) is output
Positioning mode (point table method) *1	Range where MEND (traveling completion) and INP (in-position) are output

*1 Available on servo amplifiers with firmware version B8 or later.

- Selecting an encoder for in-position range control

[Pr. PA01.4 Fully closed loop operation mode selection] setting value	In-position range unit
0 (semi closed loop control mode)	Command resolution unit (motor-side encoder)
1 (fully closed loop control mode)	Command resolution unit (load-side encoder)

- In-position range unit

[Pr. PC06.0 In-position range unit selection] setting value	Unit
0 (command unit)	Position command unit *1
1 (servo motor encoder pulse unit)	pulse

*1 The unit can be changed to 0.001 mm, 0.0001 inch, 0.001 degree or pulses with [Pr. PT01.2 Unit for position data].

☞ Page 166 [Pr. PT01.2_Unit for position data]

[Pr. PA11_Forward rotation torque limit (TLP)]

Initial value	Setting range	Setting method	Ver.
1000.0 [%]	0.0 to 1000.0	Each axis	A0

The torque or thrust generated by the servo motor can be limited.

Set this servo parameter in relation to the rated torque or continuous thrust (= 100.0 %). Set the servo parameter when limiting the torque of the servo motor for CCW power running or CW regeneration, or when limiting the thrust of the linear servo motor for positive direction power running or negative direction regeneration. If this servo parameter is set to "0.0", the servo motor does not generate torque or thrust.

The polarity of the torque limit can be changed with the setting values of [Pr. PA14 Travel direction selection] and [Pr. PC29.3 Torque POL reflection selection].

This parameter corresponds to [Positive torque limit value (Obj. 60E0h)]. When an object is mapped in cyclic communication, the controller overwrites the value written with engineering software. Thus, do not write a value with engineering software. Depending on the settings in [Pr. PC29.3] and [Pr. PA14], the corresponding object changes to [Negative torque limit value (Obj. 60E1h)].

If a value larger than the maximum torque or maximum thrust of the servo motor is set, the value will be limited to the maximum torque or maximum thrust of the servo motor.

[Pr. PA12_Reverse rotation torque limit (TLN)]

Initial value	Setting range	Setting method	Ver.
1000.0 [%]	0.0 to 1000.0	Each axis	A0

The torque or thrust generated by the servo motor can be limited.

Set this servo parameter in relation to the rated torque or continuous thrust (= 100.0 %). Set the servo parameter to limit the torque of the servo motor for CW power running or CCW regeneration, or to limit the thrust of the linear servo motor for positive direction power running or negative direction regeneration. If this servo parameter is set to "0.0", the servo motor does not generate torque or thrust.

The polarity of the torque limit can be changed with the setting values of [Pr. PA14 Travel direction selection] and [Pr. PC29.3 Torque POL reflection selection]. When an object is mapped in cyclic communication, the controller overwrites the value written with engineering software. Thus, do not write a value with engineering software.

Depending on the settings in [Pr. PC29.3] and [Pr. PA14], the corresponding object changes to [Positive torque limit value (Obj. 60E0h)].

If a value larger than the maximum torque or maximum thrust of the servo motor is set, the value will be limited to the maximum torque or maximum thrust of the servo motor.

[Pr. PA14_Travel direction selection (*POL)]

Initial value	Setting range	Setting method	Ver.
0	0 to 1	Each axis	A0

The rotation/travel direction can be changed without changing the polarity of the command from the controller.
 The polarities of the position and speed information are changed by the setting value of [Pr. PA14 Travel direction selection].
 Torque information changes with the combination of [Pr. PA14] and [Pr. PC29.3 Torque POL reflection selection].
 The rotation/travel direction is enabled regardless of the control modes. For example, when the torque polarity is changed with [Pr. PA14] and [Pr. PC29.3], the torque information polarity will also change in the position mode and positioning mode.

• Position information

Setting value of [Pr. PA14]	Servo motor rotation direction/linear servo motor travel direction	
	Positioning address increasing direction	Positioning address decreasing direction
0	CCW or positive direction	CW or negative direction
1	CW or negative direction	CCW or positive direction

• Speed information

Setting value of [Pr. PA14]	Servo motor rotation direction/linear servo motor travel direction	
	Speed handled by the controller: positive	Speed handled by the controller: negative
0	CCW or positive direction	CW or negative direction
1	CW or negative direction	CCW or positive direction

• Torque information

Setting value		Servo motor rotation direction/linear servo motor travel direction	
[Pr. PA14]	[Pr. PC29.3]	Torque handled by the controller: positive	Torque handled by the controller: negative
0	0: Enabled	CCW or positive direction	CW or negative direction
	1: Disabled		
1	0: Enabled	CW or negative direction	CCW or positive direction
	1: Disabled	CCW or positive direction	CW or negative direction

The servo motor rotation direction is as follows.

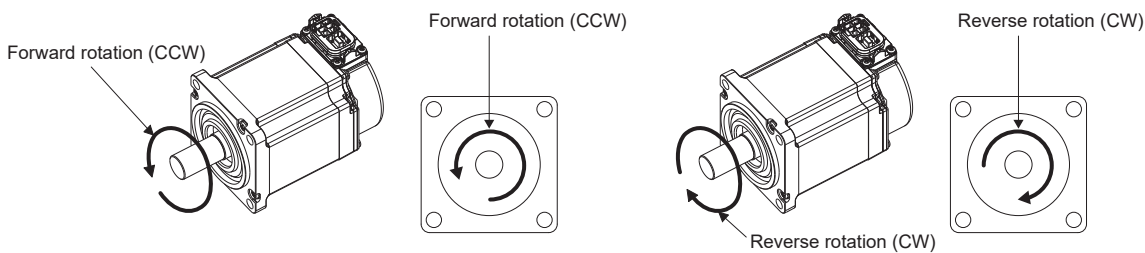

The positive and negative directions of the linear servo motor are as follows.

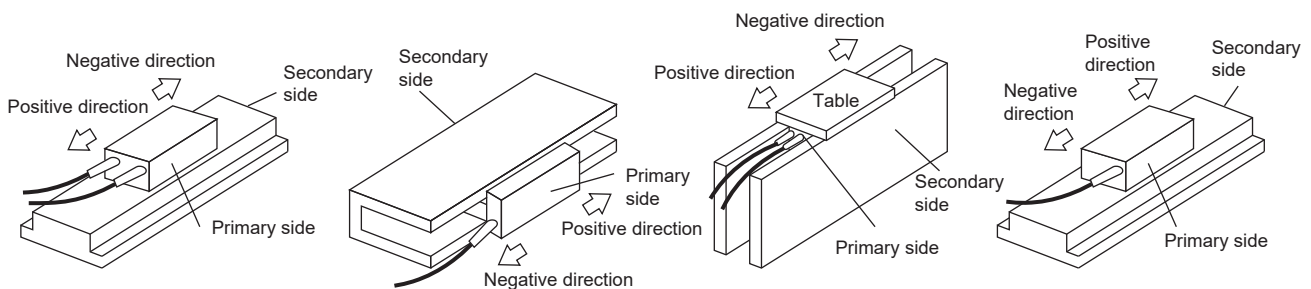

LM-H3 series/LM-F series

LM-U2 series/LM-AU series

LM-K2 series

LM-AJ series

[Pr. PA15_ Encoder output pulses (*ENR)]

Initial value	Setting range	Setting method	Ver.
4000 [pulse/rev]	1 to 67108864	Each axis	A0

Set the encoder output pulses output from the servo amplifier, by using the number of output pulses per revolution, dividing ratio, or electronic gear ratio. (after multiplication by 4)

Selecting "1" (dividing ratio setting) in [Pr. PC03.1 Encoder output pulse setting selection] will divide the travel distance [pulse] by the setting value.

Set a numerator for the electronic gear for the A/B-phase pulse output when selecting "3" (A-phase/B-phase pulse electronic gear setting) in [Pr. PC03.1].

The maximum output frequency is 4.6 Mpulses/s. Set the value within the range.

This servo parameter is not available for the MR-J5-_G_-LL servo amplifier.

[Pr. PA16_ Encoder output pulses 2 (*ENR2)]

Initial value	Setting range	Setting method	Ver.
1	1 to 67108864	Each axis	A0

Set the electronic gear denominator for the A/B-phase pulse output.

Set a denominator for the electronic gear when selecting "3" (A-phase/B-phase pulse electronic gear setting) in [Pr. PC03.1 Encoder output pulse setting selection].

When "1" (dividing ratio setting) is selected in [Pr. PC03.1 Encoder output pulse setting selection], the setting value is disabled.

The maximum output frequency is 4.6 Mpulses/s. Set the value within the range.

This servo parameter is not available for the MR-J5-_G_-LL servo amplifier.

[Pr. PA17_Servo motor series setting (**MSR)]

Initial value	Setting range	Setting method	Ver.
00000000h	Refer to the text	Each axis	A0

To select the linear servo motor to be used, set this servo parameter and [Pr. PA18.0-3 Servo motor type setting]. Set this at the same time with [Pr. PA18.0-3]. Refer to the following table for setting values.

Linear servo motor series	Linear servo motor (primary side)	Servo parameter	
		Setting value of [Pr. PA17]	Setting value of [Pr. PA18.0-3]
LM-H3	LM-H3P2A-07P-BSS0	000000BBh	2101h
	LM-H3P3A-12P-CSS0		3101h
	LM-H3P3B-24P-CSS0		3201h
	LM-H3P3C-36P-CSS0		3301h
	LM-H3P3D-48P-CSS0		3401h
	LM-H3P7A-24P-ASS0		7101h
	LM-H3P7B-48P-ASS0		7201h
	LM-H3P7C-72P-ASS0		7301h
	LM-H3P7D-96P-ASS0		7401h
LM-U2	LM-U2PAB-05M-0SS0	000000B4h	A201h
	LM-U2PAD-10M-0SS0		A401h
	LM-U2PAF-15M-0SS0		A601h
	LM-U2PBB-07M-1SS0		B201h
	LM-U2PBD-15M-1SS0		B401h
	LM-U2PBF-22M-1SS0		2601h
	LM-U2P2B-40M-2SS0		2201h
	LM-U2P2C-60M-2SS0		2301h
	LM-U2P2D-80M-2SS0		2401h
LM-F	LM-FP2B-06M-1SS0 (natural cooling)	000000B2h	2201h
	LM-FP2D-12M-1SS0 (natural cooling)		2401h
	LM-FP2F-18M-1SS0 (natural cooling)		2601h
	LM-FP4B-12M-1SS0 (natural cooling)		4201h
	LM-FP4D-24M-1SS0 (natural cooling)		4401h
	LM-FP4F-36M-1SS0 (natural cooling)		4601h
	LM-FP4H-48M-1SS0 (natural cooling)		4801h
	LM-FP5H-60M-1SS0 (natural cooling)		5801h
	LM-FP2B-06M-1SS0 (liquid-cooling)		2202h
	LM-FP2D-12M-1SS0 (liquid-cooling)		2402h
	LM-FP2F-18M-1SS0 (liquid-cooling)		2602h
	LM-FP4B-12M-1SS0 (liquid-cooling)		4202h
	LM-FP4D-24M-1SS0 (liquid-cooling)		4402h
	LM-FP4F-36M-1SS0 (liquid-cooling)		4602h
	LM-FP4H-48M-1SS0 (liquid-cooling)		4802h
	LM-FP5H-60M-1SS0 (liquid-cooling)		5802h
LM-K2	LM-K2P1A-01M-2SS1	000000B8h	1101h
	LM-K2P1C-03M-2SS1		1301h
	LM-K2P2A-02M-1SS1		2101h
	LM-K2P2C-07M-1SS1		2301h
	LM-K2P2E-12M-1SS1		2501h
	LM-K2P3C-14M-1SS1		3301h
	LM-K2P3E-24M-1SS1		3501h

Linear servo motor series	Linear servo motor (primary side)	Servo parameter	
		Setting value of [Pr. PA17]	Setting value of [Pr. PA18.0-3]
LM-AJ *1	LM-AJP1B-07K-JSS0	000000DAh	1201h
	LM-AJP1D-14K-JSS0		1401h
	LM-AJP2B-12S-JSS0		2201h
	LM-AJP2D-23T-JSS0		2401h
	LM-AJP3B-17N-JSS0		3201h
	LM-AJP3D-35R-JSS0		3401h
	LM-AJP4B-22M-JSS0		4201h
	LM-AJP4D-45N-JSS0		4401h
	LM-AU *2		LM-AUP3A-03V-JSS0
LM-AUP3B-06V-JSS0		3202h	
LM-AUP3C-09V-JSS0		3302h	
LM-AUP3D-11R-JSS0		3402h	
LM-AUP4A-04R-JSS0		4102h	
LM-AUP4B-09R-JSS0		4202h	
LM-AUP4C-13P-JSS0		4302h	
LM-AUP4D-18M-JSS0		4402h	
LM-AUP4F-26P-JSS0		4602h	
LM-AUP4H-35M-JSS0		4802h	

*1 Use servo amplifiers with firmware version B2 or later.

*2 Use servo amplifiers with firmware version D0 or later.

[Pr. PA18_Servo motor type setting (**MTY)]

Initial value	Setting range	Setting method	Ver.
00000000h	Refer to the relevant detail No.	Each axis	Refer to the relevant detail No.

[Pr. PA18.0-3_Servo motor type setting]

Initial value	Setting range	Ver.
0000h	Refer to the text	A0

When using a linear servo motor, select the linear servo motor to be used with [Pr. PA17 Servo motor series setting] and this servo parameter. Set this at the same time with [Pr. PA17]. Refer to the following for details of setting values.

☞ Page 33 [Pr. PA17_Servo motor series setting (**MSR)]

[Pr. PA19_Servo parameter writing prohibited (*BLK)]

Initial value	Setting range	Setting method	Ver.
000000ABh	Refer to the text	Each axis	A0

Select a reference range and writing range for the servo parameter.

Refer to the following table for setting values.

PA19	Setting value operation	PA	PB	PC	PD	PE	PF	PO	PS	PL, PU	PT, PV	PN	PW
Setting values not listed below	Readable	○	×	×	×	×	×	×	×	×	×	×	×
	Writable	○	×	×	×	×	×	×	×	×	×	×	×
0000000A	Readable	19 only	×	×	×	×	×	×	×	×	×	×	×
	Writable	19 only	×	×	×	×	×	×	×	×	×	×	×
0000000B	Readable	○	○	○	×	×	×	×	×	×	×	×	×
	Writable	○	○	○	×	×	×	×	×	×	×	×	×
0000000C	Readable	○	○	○	○	×	×	×	×	×	×	×	×
	Writable	○	○	○	○	×	×	×	×	×	×	×	×
0000000D	Readable	○	○	○	○	×	×	×	○	×	×	×	×
	Writable	○	○	○	○	×	×	×	○	×	×	×	×
0000000E	Readable	○	○	○	○	×	×	○	○	×	×	×	×
	Writable	○	○	○	○	×	×	○	○	×	×	×	×
0000000F	Readable	○	○	○	○	○	×	○	○	○	×	×	×
	Writable	○	○	○	○	○	×	○	○	○	×	×	×
000000AA	Readable	○	○	○	○	○	○	×	×	×	×	×	×
	Writable	○	○	○	○	○	○	×	×	×	×	×	×
000000AB (initial value)	Readable	○	○	○	○	○	○	○	○	○	○	○	○
	Writable	○	○	○	○	○	○	○	○	○	○	○	○
0000100B	Readable	○	×	×	×	×	×	×	×	×	×	×	×
	Writable	19 only	×	×	×	×	×	×	×	×	×	×	×
0000100C	Readable	○	○	○	○	×	×	×	×	×	×	×	×
	Writable	19 only	×	×	×	×	×	×	×	×	×	×	×
0000100D	Readable	○	○	○	○	×	×	×	○	×	×	×	×
	Writable	19 only	×	×	×	×	×	×	×	×	×	×	×
0000100E	Readable	○	○	○	○	×	×	○	○	×	×	×	×
	Writable	19 only	×	×	×	×	×	×	×	×	×	×	×
0000100F	Readable	○	○	○	○	○	×	○	○	○	×	×	×
	Writable	19 only	×	×	×	×	×	×	×	×	×	×	×
000010AA	Readable	○	○	○	○	○	○	×	×	×	×	×	×
	Writable	19 only	×	×	×	×	×	×	×	×	×	×	×
000010AB	Readable	○	○	○	○	○	○	○	○	○	○	○	○
	Writable	19 only	×	×	×	×	×	×	×	×	×	×	×

The settings of this servo parameter are disabled if they are read/written via engineering software (such as MR Configurator2).

The settings of this servo parameter are disabled for parameter objects.

[Pr. PA20_Tough drive setting (*TDS)]

Initial value	Setting range	Setting method	Ver.
0000000h	Refer to the relevant detail No.	Each axis	Refer to the relevant detail No.

[Pr. PA20.1_Vibration tough drive selection]

Initial value	Setting range	Ver.
0h	Refer to the text	A0

0: Disabled

1: Machine resonance suppression filter change mode enabled

2: Machine resonance suppression filter automatic setting mode

Selecting other than "0" for this servo parameter suppresses vibrations by automatically changing the setting values of [Pr. PB13 Machine resonance suppression filter 1] and [Pr. PB15 Machine resonance suppression filter 2] if the vibration exceeds the value of the oscillation level set in [Pr. PF23 Vibration tough drive - Oscillation detection level].

For "1", the vibration tough drive functions when [Pr. PB13] and [Pr. PB15] are enabled. For "2", the vibration tough drive functions even when [Pr. PB13] and [Pr. PB15] are disabled.

When using the vibration tough drive, selecting "2" (machine resonance suppression filter automatic setting mode) is recommended.

[Pr. PA20.2_SEMI-F47 function selection]

Initial value	Setting range	Ver.
0h	Refer to the text	A0

0: Disabled

1: Enabled

Selecting "1" enables to avoid triggering [AL. 010 Undervoltage] by using the electrical energy charged in the capacitor in case that an instantaneous power failure occurs during operation. In [Pr. PF25 SEMI-F47 function - Instantaneous power failure detection time (Instantaneous power failure tough drive detection time)], the time until the occurrence of [AL. 010.1 Voltage drop in the control circuit power] can be set.

For multi axis servo amplifiers, SEMI-F47 function cannot enable specific axis separately. Therefore, when using SEMI-F47 function, enable all axes.

Setting this servo parameter to "1" on the MR-J5D_ _G_ triggers [AL. 037 Parameter error].

When a common bus connection using a servo amplifier with a capacity of 12 kW to 25 kW as the main unit is constructed, the SEMI-F47 function cannot be used. Set this servo parameter to "0" (disabled). The power may be turned off normally even if this servo parameter is set to "1" (enabled) and [Pr. PF25 SEMI-F47 function - Instantaneous power failure detection time (Instantaneous power failure tough drive detection time)] is set. For details, refer to "Common bus connection system using an MR-J5 servo amplifier with a capacity of 12 kW or more as the main unit" in the User's Manual (Hardware) or "Compliance with SEMI-F47 standard" in the User's Manual (Function).

[Pr. PA21_Function selection A-3 (*AOP3)]

Initial value	Setting range	Setting method	Ver.
00000001h	Refer to the relevant detail No.	Each axis	Refer to the relevant detail No.

[Pr. PA21.0_One-touch tuning function selection]

Initial value	Setting range	Ver.
1h	Refer to the text	A0

0: Disabled

1: Enabled

When the servo parameter is set to "0", the one-touch tuning cannot be performed.

[Pr. PA22_Position control configuration selection (**PCS)]

Initial value	Setting range	Setting method	Ver.
00000000h	Refer to the relevant detail No.	Each axis	Refer to the relevant detail No.

[Pr. PA22.1_Super trace function selection]

Initial value	Setting range	Ver.
0h	Refer to the text	A5

0: Disabled

2: Enabled

This servo parameter is not available for the MR-J5-_G_-LL servo amplifier.

[Pr. PA22.3_Scale measurement function selection]

Initial value	Setting range	Ver.
0h	Refer to the text	A5

The absolute position detection system cannot be used when an incremental type encoder is used. At this time, enabling the absolute position detection system triggers [AL. 037 Parameter error]. In the fully closed loop control mode, setting a value other than "0" triggers [AL. 037].

If the absolute position detection system is disabled or switched to the incremental system, the home position is erased.

Setting "1" or "2" on the MR-J5W3-_G_ triggers [AL. 037].

0: Disabled

1: Use with absolute position detection system

2: Use with incremental system

By setting [Pr. PF63.1 [AL. 01A.6 Servo motor combination error 4] selection] to "1" (disabled) while the absolute position detection system is enabled, an in-use batteryless absolute position scale measurement encoder can be replaced without changing the setting value of [Pr. PA03.2 Scale measurement encoder replacement preparation].

Connecting a scale measurement encoder that had not been connected at the startup of the absolute position detection system will cause [AL. 025 Absolute position erased], erasing absolute position data.

Therefore, check if a correct scale measurement encoder is connected.

This servo parameter is not available for the MR-J5-_G_-LL servo amplifier.

[Pr. PA23_Drive recorder desired alarm trigger setting (DRAT)]

Initial value	Setting range	Setting method	Ver.
00000000h	Refer to the relevant detail No.	Common	Refer to the relevant detail No.

This servo parameter is enabled in the following conditions:

- [Pr. PF80.0 Drive recorder - Operation mode selection] = "0" (automatic setting mode)
- [Pr. PF80.0] = "1" (manual setting mode) and [Pr. PF82.0 Drive recorder - Trigger mode selection] = "0" (alarm trigger)

Ex.

To activate the drive recorder when [AL. 050 Overload 1] occurs, set "00005000h".

To activate the drive recorder when [AL. 050.3 Thermal overload error 4 during operation] occurs, set this servo parameter to "00005003h".

[Pr. PA23.0-1_Alarm detail number setting]

Initial value	Setting range	Ver.
00h	00h to FFh	A0

Set this to execute the trigger with a desired alarm detail No. for the drive recorder function.

When "00h" is selected, only the desired alarm No. setting will be enabled.

[Pr. PA23.2-4_Alarm number setting]

Initial value	Setting range	Ver.
000h	000h to FFFh	A0

Set this to execute the trigger with a desired alarm No. for the drive recorder function.

When "000h" is selected, the desired alarm trigger of the drive recorder is disabled.

[Pr. PA24_Function selection A-4 (AOP4)]

Initial value	Setting range	Setting method	Ver.
00000000h	Refer to the relevant detail No.	Each axis	Refer to the relevant detail No.

[Pr. PA24.0_Vibration suppression mode selection]

Initial value	Setting range	Ver.
0h	Refer to the text	A0

0: Standard mode

1: 3 inertia mode

2: Low response mode

4: Path tracking mode

When other than "3 inertia mode" is selected, vibration suppression control 2 cannot be used.

Before changing the control mode in "3 inertia mode" or "low response mode", stop the motor.

Before changing the control mode in "path tracking mode", stop the motor.

[Pr. PA24.5_Load to motor inertia ratio/load to motor mass ratio estimation higher precision selection]

Initial value	Setting range	Ver.
0h	Refer to the text	C4

Select whether to enable or disable estimation with higher precision for the load to motor inertia ratio/load to motor mass ratio.

0: Disabled

1: Enabled

When this servo parameter is set to "0" (disabled), [Pr. PB06 Load to motor inertia ratio/load to motor mass ratio] may be estimated at a value smaller than the accurate estimation depending on the operation pattern. Therefore, this servo parameter is recommended to be set to "1" (enabled).

Setting this servo parameter to "1" (enabled) with the equipment on which the gain is adjusted may change the actual movement. Check the movement of the equipment after changing the settings.

[Pr. PA25_One-touch tuning - Overshoot permissible level (OTHOV)]

Initial value	Setting range	Setting method	Ver.
0 [%]	0 to 100	Each axis	A0

Set a permissible value of overshoot amount for one-touch tuning as a percentage of the in-position range.

When "0" is set, 50 % is applied.

[Pr. PA26_Function selection A-5 (*AOP5)]

Initial value	Setting range	Setting method	Ver.
00000000h	Refer to the relevant detail No.	Each axis	Refer to the relevant detail No.

[Pr. PA26.0_Torque limit function selection at instantaneous power failure]

Initial value	Setting range	Ver.
0h	Refer to the text	A0

0: Disabled

1: Enabled

By setting "1", if an instantaneous power failure occurs during operation, limiting the torque at acceleration saves the electric energy charged in the capacitor in the servo amplifier. And consequently the time until [AL. 010.2 Voltage drop in the main circuit power] occurs can be delayed with instantaneous power failure tough drive function. Thus, the time to be set in [Pr. PF25 SEMI-F47 function - Instantaneous power failure detection time (Instantaneous power failure tough drive detection time)] can be extended.

The torque limit function at instantaneous power failure is enabled when [Pr. PA20.2 SEMI-F47 function selection] is "1" (enabled).

This function cannot be used on the MR-J5W_ _G_ . When this parameter is enabled, [AL. 037 Parameter error] occurs.

This function is disabled in the cyclic synchronous torque mode (cst), profile torque mode (tq), cyclic synchronous pressure mode (cspr), and slave axis torque mode (slt).

[Pr. PA28_Function selection A-6 (**AOP6)]

Initial value	Setting range	Setting method	Ver.
00000000h	Refer to the relevant detail No.	Each axis	Refer to the relevant detail No.

[Pr. PA28.4_Speed range limit selection]

Initial value	Setting range	Ver.
0h	Refer to the text	A0

Select the speed to be used for the range restriction of the speed data.

If "1" (permissible speed) is set when the servo amplifier is connected with a servo motor of HK series, the maximum speed will be selected.

0: Maximum speed

1: Permissible speed

[Pr. PA34_Quick tuning - Permissible travel distance (QDIS)]

Initial value	Setting range	Setting method	Ver.
0 [0.1 rev], [mm]	0 to 100	Each axis	A0

Set the permissible travel distance for quick tuning.

If the travel distance for quick tuning exceeds the setting value, the quick tuning error occurs.

When "0" is input, the permissible travel distance for quick tuning is 1.0 rev (when a linear servo motor is used, 10 mm).

1.3 Gain/filter setting servo parameters group ([Pr. PB_ _])

[Pr. PB01_Adaptive tuning mode (adaptive filter II) (FILT)]

Initial value	Setting range	Setting method	Ver.
00000000h	Refer to the relevant detail No.	Each axis	Refer to the relevant detail No.

[Pr. PB01.0_Filter tuning mode selection]

Initial value	Setting range	Ver.
0h	Refer to the text	A0

Setting of the adaptive tuning is performed.

Select the adjustment mode of the machine resonance suppression filter 1.

0: Disabled

1: Automatic setting

2: Manual setting

When the servo parameter is set to "automatic setting", [Pr. PB13 Machine resonance suppression filter 1] and [Pr. PB14 Notch shape selection 1] will be set automatically. The automatic setting of machine resonance suppression filter 1 cannot be used if quick tuning is in progress. While quick tuning is in progress, adaptive filter II (adaptive tuning) does not start even if the automatic setting of machine resonance suppression filter 1 is used. The results obtained from the quick tuning are applied to [Pr. PB13] and [Pr. PB14].

Do not use the automatic setting in the torque mode.

[Pr. PB01.3_Tuning accuracy selection]

Initial value	Setting range	Ver.
0h	Refer to the text	A0

0: Standard

1: High accuracy

In the high accuracy mode, the sound during tuning may be larger than in the standard mode, but the frequency is estimated more accurately.

[Pr. PB02_Vibration suppression control tuning mode (advanced vibration suppression control II) (VRFT)]

Initial value	Setting range	Setting method	Ver.
00000000h	Refer to the relevant detail No.	Each axis	Refer to the relevant detail No.

[Pr. PB02.0_Vibration suppression control 1 - Tuning mode selection]

Initial value	Setting range	Ver.
0h	Refer to the text	A0

Select the tuning mode of the vibration suppression control 1.

- 0: Disabled
- 1: Automatic setting
- 2: Manual setting

[Pr. PB02.1_Vibration suppression control 2 - Tuning mode selection]

Initial value	Setting range	Ver.
0h	Refer to the text	A0

Select the tuning mode of the vibration suppression control 2. To enable the setting value, set [Pr. PA24.0 Vibration suppression mode selection] to "1" (3 inertia mode).

- 0: Disabled
- 1: Automatic setting
- 2: Manual setting

[Pr. PB03_Torque feedback loop gain (TFBGN)]

When the command interface of the servo amplifier is EtherCAT, this servo parameter is not available.

Initial value	Setting range	Setting method	Ver.
36000 [rad/s]	0 to 36000	Each axis	B0

Set the torque feedback gain.

This function is enabled in the continuous operation to torque control mode.

Decreasing the setting value of this servo parameter reduces the collision load during pressing.

6 rad/s is set when the setting value is 6 rad/s or less.

[Pr. PB04_Feed forward gain (FFC)]

Initial value	Setting range	Setting method	Ver.
0 [%]	0 to 100	Each axis	A0

Set the feed forward gain.

When "100" is set, the droop pulses are almost 0 in operation at the constant speed. If the super trace control is enabled, the droop pulses are almost 0 in operation at uniform acceleration/deceleration, as well as at the constant speed. However, if sudden acceleration/deceleration is performed, overshoot becomes large. When the feed forward gain is set to 100 %, set a value not smaller than 1 s for the acceleration time constant until the rated speed is reached.

[Pr. PB06_Load to motor inertia ratio/load to motor mass ratio (GD2)]

Initial value	Setting range	Setting method	Ver.
7.00 [times]	0.00 to 300.00	Each axis	A0

Set the load to motor inertia ratio or load to motor mass ratio. Setting a value different from the actual load moment of inertia or load mass may cause an unexpected operation such as an overshoot.

The setting of this servo parameter will be automatic or manual depending on the setting value of [Pr. PA08.0 Gain adjustment mode selection]. Refer to the following table for details. When the servo parameter is set to automatic setting, the value varies within the range of 0.00 to 100.00.

[Pr. PA08.0 Gain adjustment mode selection]	Servo parameter status
"0" (2 gain adjustment mode 1 (interpolation mode))	Automatic setting
"1" (auto tuning mode 1)	
"2" (auto tuning mode 2)	Manual setting
"3" (manual mode)	
"4" (2 gain adjustment mode 2)	
"5" (quick tuning mode)	Automatic setting
"6" (load to motor inertia ratio monitor mode)	

[Pr. PB07_Model control gain (PG1)]

Initial value	Setting range	Setting method	Ver.
15.0 [rad/s]	1.0 to 8000.0	Each axis	A0

Set the response gain to the target position.

Increasing the setting value improves responsiveness to the position command, but increasing the value too much raises the likelihood of vibration and noise.

The setting of this servo parameter will be automatic or manual depending on the setting value of [Pr. PA08.0 Gain adjustment mode selection]. Refer to the following table for details.

[Pr. PA08.0]	Servo parameter status
"0" (2 gain adjustment mode 1 (interpolation mode))	Manual setting
"1" (auto tuning mode 1)	Automatic setting
"2" (auto tuning mode 2)	
"3" (manual mode)	Manual setting
"4" (2 gain adjustment mode 2)	Automatic setting
"5" (quick tuning mode)	
"6" (load to motor inertia ratio monitor mode)	Manual setting

When the vibration suppression control is enabled, the settable range of [Pr. PB07 Model control gain] is limited. If [Pr. PB07] exceeds the settable range, the vibration suppression control is disabled.

[Pr. PB08_Position control gain (PG2)]

Initial value	Setting range	Setting method	Ver.
37.0 [rad/s]	1.0 to 2000.0	Each axis	A0

Set the gain of the position loop.

Set this servo parameter when increasing the position responsiveness to level load disturbance.

Increasing the setting value improves responsiveness to the load disturbance, but increasing the value too much raises the likelihood of vibration and noise.

The setting of this servo parameter will be automatic or manual depending on the setting value of [Pr. PA08.0 Gain adjustment mode selection]. Refer to the following table for details.

[Pr. PA08.0]	Servo parameter status
"0" (2 gain adjustment mode 1 (interpolation mode))	Automatic setting
"1" (auto tuning mode 1)	
"2" (auto tuning mode 2)	
"3" (manual mode)	Manual setting
"4" (2 gain adjustment mode 2)	Automatic setting
"5" (quick tuning mode)	
"6" (load to motor inertia ratio monitor mode)	Manual setting

[Pr. PB09_Speed control gain (VG2)]

Initial value	Setting range	Setting method	Ver.
823 [rad/s]	20 to 65535	Each axis	A0

Set the gain of the speed loop.

Set this servo parameter when vibration occurs on machines with low rigidity or with large backlash. Increasing the setting value improves responsiveness, but increasing the value too much raises the likelihood of vibration and noise.

The setting of this servo parameter will be automatic or manual depending on the setting value of [Pr. PA08.0 Gain adjustment mode selection]. Refer to the following for details.

☞ Page 44 [Pr. PB08_Position control gain (PG2)]

[Pr. PB10_Speed integral compensation (VIC)]

Initial value	Setting range	Setting method	Ver.
33.7 [ms]	0.1 to 1000.0	Each axis	A0

Set the integral time constant of the speed loop.

Decreasing the setting value improves responsiveness, but raises the likelihood of vibration and noise.

The setting of this servo parameter will be automatic or manual depending on the setting value of [Pr. PA08.0 Gain adjustment mode selection]. Refer to the following for details.

☞ Page 44 [Pr. PB08_Position control gain (PG2)]

[Pr. PB11_Speed differential compensation (VDC)]

Initial value	Setting range	Setting method	Ver.
980	0 to 1000	Each axis	A0

Set the differential compensation.

The enabling conditions vary depending on the setting value in [Pr. PB24.1 PI-PID switching control selection].

[Pr. PB24.1]	The enabling conditions for this servo parameter
"0" (switching is enabled by PID switching signal (C_PC) from controller and the input device (PC))	Enabled by turning on the PID switching signal from controller (C_PC), or by turning on the PC (Proportional control)
"3" (Continuous PID control (proportional control) enabled)	Always enabled

[Pr. PB12_Overshoot amount compensation (OVA)]

Initial value	Setting range	Setting method	Ver.
0 [%]	0 to 100	Each axis	A0

Set a dynamic friction torque in percentage to the rated torque at servo motor rated speed. Alternatively, set a percentage of dynamic friction force against the continuous thrust at linear servo motor rated speed.

If the response level is too low or if the torque/thrust is limited, the efficiency of the servo parameter may decrease.

[Pr. PB13_Machine resonance suppression filter 1 (NH1)]

Initial value	Setting range	Setting method	Ver.
4500 [Hz]	10 to 9000	Each axis	A0

Set the notch frequency of the machine resonance suppression filter 1.

When [Pr. PA08.0 Gain adjustment mode selection] is set to "5" (quick tuning mode), the setting value of this servo parameter reflects the adjustment result of quick tuning.

When [Pr. PB01.0 Filter tuning mode selection] is set to "1" (automatic setting), the values obtained from adaptive tuning are applied to the setting value of this servo parameter.

When [Pr. PB01.0] is set to "2" (manual setting), set the notch frequency with this servo parameter.

[Pr. PB14_Notch shape selection 1 (NHQ1)]

Initial value	Setting range	Setting method	Ver.
00000000h	Refer to the relevant detail No.	Each axis	Refer to the relevant detail No.

[Pr. PB14.1_Notch depth selection 1]

Initial value	Setting range	Ver.
0h	Refer to the text	A0

0: -40 dB

1: -14 dB

2: -8 dB

3: -4 dB

[Pr. PB14.2_Notch width selection 1]

Initial value	Setting range	Ver.
0h	Refer to the text	A0

0: $\alpha = 2$

1: $\alpha = 3$

2: $\alpha = 4$

3: $\alpha = 5$

[Pr. PB15_Machine resonance suppression filter 2 (NH2)]

Initial value	Setting range	Setting method	Ver.
4500 [Hz]	10 to 9000	Each axis	A0

Set the notch frequency of the machine resonance suppression filter 2.

When [Pr. PA08.0 Gain adjustment mode selection] is set to "5" (quick tuning mode), the setting value of this servo parameter reflects the adjustment result of quick tuning.

When [Pr. PB16.0 Machine resonance suppression filter 2 selection] is set to "1" (enabled), set the notch frequency with this servo parameter.

[Pr. PB16_Notch shape selection 2 (NHQ2)]

Initial value	Setting range	Setting method	Ver.
00000000h	Refer to the relevant detail No.	Each axis	Refer to the relevant detail No.

Set forms of the machine resonance suppression filter 2.

When [Pr. PA08.0 Gain adjustment mode selection] is set to "5" (quick tuning mode), the setting value of this servo parameter reflects the adjustment result of quick tuning.

[Pr. PB16.0_Machine resonance suppression filter 2 selection]

Initial value	Setting range	Ver.
0h	Refer to the text	A0

0: Disabled

1: Enabled

[Pr. PB16.1_Notch depth selection]

Initial value	Setting range	Ver.
0h	Refer to the text	A0

0: -40 dB

1: -14 dB

2: -8 dB

3: -4 dB

[Pr. PB16.2_Notch width selection]

Initial value	Setting range	Ver.
0h	Refer to the text	A0

0: $\alpha = 2$

1: $\alpha = 3$

2: $\alpha = 4$

3: $\alpha = 5$

[Pr. PB17_Shaft resonance suppression filter (NHF)]

Initial value	Setting range	Setting method	Ver.
00000000h	Refer to the relevant detail No.	Each axis	Refer to the relevant detail No.

Set the shaft resonance suppression filter.

Use this to suppress a high-frequency machine vibration.

When [Pr. PB23.0 Shaft resonance suppression filter selection] is set to "0" (automatic setting), the value will be calculated automatically from the servo motor used and load to motor inertia ratio. Automatic setting is not carried out when the linear servo motor is used. When "1" (manual setting) is selected, set the shaft resonance suppression filter with this servo parameter.

When [Pr. PB23.0] is set to "2" (disabled), this servo parameter setting is disabled. As a result, the filter performance may be reduced.

When [Pr. PB49.0 Machine resonance suppression filter 4 selection] is set to "1" (enabled), the shaft resonance suppression filter cannot be used.

[Pr. PB17.0-1_Shaft resonance suppression filter setting - Frequency selection]

Initial value	Setting range	Ver.
00h	Refer to the text	A0

Refer to the following table for setting values.

Set the value closest to the required frequency.

Setting value	Frequency [Hz]
00	Disabled
01	Disabled
02	4500
03	3000
04	2250
05	1800
06	1500
07	1285
08	1125
09	1000
0A	900
0B	818
0C	750
0D	692
0E	642
0F	600
10	562
11	529
12	500
13	473
14	450
15	428
16	409
17	391
18	375
19	360
1A	346
1B	333
1C	321
1D	310
1E	300

Setting value	Frequency [Hz]
1F	290
20	Disabled
21	Disabled
22	Disabled
23	Disabled
24	Disabled
25	Disabled
26	Disabled
27	Disabled
28	4500
29	4000
2A	3600
2B	3272
2C	3000
2D	2769
2E	2571
2F	2400
30	2250
31	2117
32	2000
33	1894
34	1800
35	1714
36	1636
37	1565
38	1500
39	1440
3A	1384
3B	1333
3C	1285
3D	1241
3E	1200
3F	1161
40	1125
41	1090
42	1058
43	1028
44	1000
45	972
46	947
47	923
48	900
49	878
4A	857
4B	837
4C	818
4D	800
4E	782
4F	765
50	750
51	734
52	720
53	705

Setting value	Frequency [Hz]
54	692
55	679
56	666
57	654
58	642
59	631
5A	620
5B	610
5C	600
5D	590
5E	580
5F	571
60	562
61	553
62	545
63	537
64	529
65	521
66	514
67	507
68	500
69	493
6A	486
6B	480
6C	473
6D	467
6E	461
6F	455
70	450
71	444
72	439
73	433
74	428
75	423
76	418
77	413
78	409
79	404
7A	400
7B	395
7C	391
7D	387
7E	382
7F	378
80	375
81	371
82	367
83	363
84	360
85	356
86	352
87	349
88	346

Setting value	Frequency [Hz]
89	342
8A	339
8B	336
8C	333
8D	330
8E	327
8F	324
90	321
91	318
92	315
93	313
94	310
95	307
96	305
97	302
98	300
99	297
9A	295
9B	292
9C	290
9D	288
9E	285
9F	283

[Pr. PB17.2_Notch depth selection]

Initial value	Setting range	Ver.
0h	Refer to the text	A0

- 0: -40 dB
- 1: -14 dB
- 2: -8 dB
- 3: -4 dB

[Pr. PB18_Low-pass filter setting (LPF)]

Initial value	Setting range	Setting method	Ver.
3141 [rad/s]	100 to 36000	Each axis	A0

Set the low-pass filter.

Refer to the table below for the status of this servo parameter and the setting values of the related servo parameter.

When [Pr. PA08.0 Gain adjustment mode selection] is set to "5" (quick tuning mode), this servo parameter returns to the initial value.

[Pr. PB23.1 Low-pass filter selection]	[Pr. PB18 Low-pass filter setting]
"0" (initial value)	Automatic setting
"1"	Setting value enabled
"2"	Setting value disabled

[Pr. PB19_Vibration suppression control 1 - Vibration frequency (VRF11)]

Initial value	Setting range	Setting method	Ver.
100.0 [Hz]	0.1 to 300.0	Each axis	A0

Set the vibration frequency of vibration suppression control 1 to suppress low-frequency machine vibration.

When "1" (automatic setting) is selected in [Pr. PB02.0 Vibration suppression control 1 - Tuning mode selection], this servo parameter will be set automatically. When "2" (manual setting) is selected, set the vibration frequency with this servo parameter.

If [Pr. PB25.0 Model adaptive control selection] is set to "2" (disabled), the vibration suppression control cannot be used. The available range of [Pr. PB19 Vibration suppression control 1 - Vibration frequency] depends on the value in [Pr. PB07 Model control gain]. If the setting value of [Pr. PB19] exceeds the available range, the vibration suppression control is disabled.

[Pr. PB20_Vibration suppression control 1 - Resonance frequency (VRF12)]

Initial value	Setting range	Setting method	Ver.
100.0 [Hz]	0.1 to 300.0	Each axis	A0

Set the resonance frequency of vibration suppression control 1 to suppress low-frequency machine vibration.

When "1" (automatic setting) is selected in [Pr. PB02.0 Vibration suppression control 1 - Tuning mode selection], this servo parameter will be set automatically. When "2" (manual setting) is selected, set the resonance frequency with this servo parameter.

If [Pr. PB25.0 Model adaptive control selection] is set to "2" (disabled), the vibration suppression control cannot be used. The available range of [Pr. PB20 Vibration suppression control 1 - Resonance frequency] changes depending on the value in [Pr. PB07 Model control gain]. If the setting value of [Pr. PB20] exceeds the available range, the vibration suppression control is disabled.

[Pr. PB21_Vibration suppression control 1 - Vibration frequency damping (VRF13)]

Initial value	Setting range	Setting method	Ver.
0.00	0.00 to 0.30	Each axis	A0

Set the damping of the vibration frequency for vibration suppression control 1 to suppress low-frequency machine vibration.

When "1" (automatic setting) is selected in [Pr. PB02.0 Vibration suppression control 1 - Tuning mode selection], this servo parameter will be set automatically. When "2" (manual setting) is selected, set the damping of the vibration frequency with this servo parameter.

[Pr. PB22_Vibration suppression control 1 - Resonance frequency damping (VRF14)]

Initial value	Setting range	Setting method	Ver.
0.00	0.00 to 0.30	Each axis	A0

Set the damping of the resonance frequency for vibration suppression control 1 to suppress low-frequency machine vibration.

When "1" (automatic setting) is selected in [Pr. PB02.0 Vibration suppression control 1 - Tuning mode selection], this servo parameter will be set automatically. When "2" (manual setting) is selected, set the damping of the resonance frequency with this servo parameter.

[Pr. PB23_Low-pass filter selection (VFBF)]

Initial value	Setting range	Setting method	Ver.
00001000h	Refer to the relevant detail No.	Each axis	Refer to the relevant detail No.

[Pr. PB23.0_Shaft resonance suppression filter selection]

Initial value	Setting range	Ver.
0h	Refer to the text	A0

Select the shaft resonance suppression filter.

- 0: Automatic setting
- 1: Manual setting
- 2: Disabled

When [Pr. PB49.0 Machine resonance suppression filter 4 selection] is set to "1" (enabled), the shaft resonance suppression filter cannot be used.

[Pr. PB23.1_Low-pass filter selection]

Initial value	Setting range	Ver.
0h	Refer to the text	A0

Select the low-pass filter.

- 0: Automatic setting
- 1: Manual setting
- 2: Disabled

When "5" (quick tuning mode) is selected in [Pr. PA08.0 Gain adjustment mode selection], this servo parameter is set to "1" (manual setting).

[Pr. PB23.3_Shaft resonance suppression filter 2 selection]

Initial value	Setting range	Ver.
1h	Refer to the text	A0

- 0: Disabled
- 1: Automatic setting

[Pr. PB24_Slight vibration suppression control (*MVS)]

Initial value	Setting range	Setting method	Ver.
00000000h	Refer to the relevant detail No.	Each axis	Refer to the relevant detail No.

[Pr. PB24.0_Slight vibration suppression control selection]

Initial value	Setting range	Ver.
0h	Refer to the text	A0

Select the slight vibration suppression control.

0: Disabled

1: Enabled

The slight vibration suppression control is enabled when "3" (manual mode) is selected in [Pr. PA08.0 Gain adjustment mode selection].

The slight vibration suppression control selection can be used in the position mode and positioning mode.

[Pr. PB24.1_PI-PID switching control selection]

Initial value	Setting range	Ver.
0h	Refer to the text	A0

0: PI control enabled (switching is enabled by PID switching signal (C_PC) from controller and the input device (PC))

3: Continuous PID control (proportional control) enabled

If the servo motor at a stop is rotated even for a pulse due to any external factor, it generates torque to compensate for a position mismatch. When the servo motor shaft is to be locked mechanically after positioning completion (stop), enabling the PID control and completing positioning simultaneously will suppress the unnecessary torque generated to compensate for a position mismatch.

[Pr. PB25_Function selection B-1 (*BOP1)]

Initial value	Setting range	Setting method	Ver.
00000000h	Refer to the relevant detail No.	Each axis	Refer to the relevant detail No.

[Pr. PB25.0_Model adaptive control selection]

Initial value	Setting range	Ver.
0h	Refer to the text	A0

0: Enabled (model adaptive control)

2: Disabled (PID control)

When "Disabled" is set, vibration suppression control 1 and 2 cannot be used. The overshoot compensation will be disabled.

[Pr. PB26_Gain switching function (*CDP)]

Initial value	Setting range	Setting method	Ver.
00000000h	Refer to the relevant detail No.	Each axis	Refer to the relevant detail No.

Select the gain switching condition.

Set the conditions to enable the following values: the gain switching values that have been set from [Pr. PB29 Gain switching - Load to motor inertia ratio/load to motor mass ratio] to [Pr. PB36 Gain switching - Vibration suppression control 1 - Resonance frequency damping] and from [Pr. PB56 Gain switching - Vibration suppression control 2 - Vibration frequency] to [Pr. PB60 Gain switching - Model control gain], and the values of gain switching 2 that have been set from [Pr. PB67 Gain switching 2 - Load to motor inertia ratio/load to motor mass ratio] to [Pr. PB79 Gain switching 2 - Model control gain].

[Pr. PB26.0_Gain switching selection]

Initial value	Setting range	Ver.
0h	Refer to the text	A0

- 0: Disabled
- 1: Signal (CDP/C_CDP)
- 2: Command frequency
- 3: Droop pulses
- 4: Servo motor speed
- 5: Command direction

When "1" is selected, the gain changes to "Gain after gain switching" by using the control command (C_CDP) from the controller or the input device CDP (Gain switching).

When "2" is selected, set [Pr. PT01.2 Unit for position data] to "3" (pulse). Setting [Pr. PT01.2] to a value other than "3" disables gain switching.

[Pr. PB26.1_Gain switching condition selection]

Initial value	Setting range	Ver.
0h	Refer to the text	A0

- 0: Gain after "Gain switching" is enabled with the condition value or more for gain switching
- 1: Gain after "Gain switching" is enabled with the condition value or less for gain switching

[Pr. PB26.2_Gain switching time constant - Disabling condition selection]

Initial value	Setting range	Ver.
0h	Refer to the text	A0

- 0: Switching time constant enabled
- 1: Time constant disabled at switching
- 2: Time constant disabled at return

[Pr. PB26.4_Gain switching 2 selection]

Initial value	Setting range	Ver.
0h	Refer to the text	A0

0: Disabled

1: Signal (CDP2/C_CDP2)

2: The same condition as [Pr. PB26.0 Gain switching selection]

When "1" is selected, the gain changes to "Gain after gain switching 2" by using the control command (C_CDP2) from the controller or the input device CDP2 (Gain switching 2).

When "1" is set in [Pr. PB26.0] while "2" has been selected for this servo parameter, the gain changes to "Gain after gain switching 2" by the control command (C_CDP2) from the controller or the input device CDP2 (Gain switching 2).

[Pr. PB26.5_Gain switching selection during a stop]

Initial value	Setting range	Ver.
0h	Refer to the text	A0

0: Gain switching 2 during a stop is disabled

1: Gain switching 2 during a stop is enabled

This servo parameter is enabled in the following condition: [Pr. PB26.4 Gain switching 2 selection] is set to "2" (the same condition as [Pr. PB26.0 Gain switching selection]) and [Pr. PB26.0] is set to "5" (command direction) in the position mode and positioning mode.

[Pr. PB27_Gain switching condition (CDL)]

Initial value	Setting range	Setting method	Ver.
10 [Refer to the text below for the unit.]	0 to 16777215	Each axis	A0

Set the value of the gain switching (command frequency, droop pulses, or servo motor speed) selected in [Pr. PB26 Gain switching function].

The set value unit differs depending on the switching condition item. The units are as follows: [kpulse/s] for command frequency, [pulse] for droop pulses, and [r/min] for servo motor speed.

If using a linear servo motor, the unit of the servo motor speed is [mm/s].

[Pr. PB28_Gain switching time constant (CDT)]

Initial value	Setting range	Setting method	Ver.
1 [ms]	0 to 100	Each axis	A0

Set the time constant until the gain switches in response to the conditions set in [Pr. PB26 Gain switching function] and [Pr. PB27 Gain switching condition].

[Pr. PB29_Gain switching - Load to motor inertia ratio/load to motor mass ratio (GD2B)]

Initial value	Setting range	Setting method	Ver.
7.00 [times]	0.00 to 300.00	Each axis	A0

Set the load to motor inertia ratio/load to motor mass ratio for when gain switching is enabled.

The setting value of this servo parameter is enabled when [Pr. PA08.0 Gain adjustment mode selection] is set to "3" (manual mode).

[Pr. PB30_Gain switching - Position control gain (PG2B)]

Initial value	Setting range	Setting method	Ver.
0.0 [rad/s]	0.0 to 2000.0	Each axis	A0

Set the position control gain for when the gain switching is enabled.

When the setting value of this servo parameter is less than "1.0", the setting value of [Pr. PB08 Position control gain] is applied.

The setting value of this servo parameter is enabled when [Pr. PA08.0 Gain adjustment mode selection] is set to "3" (manual mode).

[Pr. PB31_Gain switching - Speed control gain (VG2B)]

Initial value	Setting range	Setting method	Ver.
0 [rad/s]	0 to 65535	Each axis	A0

Set the speed control gain for when the gain switching is enabled.

When the setting value of this servo parameter is less than "20", the setting value of [Pr. PB09 Speed control gain] is applied.

The setting value of this servo parameter is enabled when [Pr. PA08.0 Gain adjustment mode selection] is set to "3" (manual mode).

[Pr. PB32_Gain switching - Speed integral compensation (VICB)]

Initial value	Setting range	Setting method	Ver.
0.0 [ms]	0.0 to 5000.0	Each axis	A0

Set the speed integral compensation for when the gain switching is enabled.

When the setting value of this servo parameter is less than "0.1", the setting value of [Pr. PB10 Speed integral compensation] is applied.

The setting value of this servo parameter is enabled when [Pr. PA08.0 Gain adjustment mode selection] is set to "3" (manual mode).

[Pr. PB33_Gain switching - Vibration suppression control 1 - Vibration frequency (VRF11B)]

Initial value	Setting range	Setting method	Ver.
0.0 [Hz]	0.0 to 300.0	Each axis	A0

Set the vibration frequency of vibration suppression control 1 for when the gain switching is enabled.

When the setting value of this servo parameter is less than "0.1", the setting value of [Pr. PB19 Vibration suppression control 1 - Vibration frequency] is applied.

This servo parameter is enabled in the following conditions:

- [Pr. PA08.0 Gain adjustment mode selection] is set to "3" (manual mode).
- [Pr. PB02.0 Vibration suppression control 1 - Tuning mode selection] is set to "2" (manual setting).
- "1" (signal (CDP/C_CDP)) is selected in [Pr. PB26.0 Gain switching selection].

Switching gains during driving may cause a shock. Switch the gains after the servo motor has stopped.

[Pr. PB34_Gain switching - Vibration suppression control 1 - Resonance frequency (VRF12B)]

Initial value	Setting range	Setting method	Ver.
0.0 [Hz]	0.0 to 300.0	Each axis	A0

Set the resonance frequency for vibration suppression control 1 for when the gain switching is enabled.

When the setting value of this servo parameter is less than "0.1", the setting value of [Pr. PB20 Vibration suppression control 1 - Resonance frequency] is applied.

This servo parameter is enabled in the following conditions:

- [Pr. PA08.0 Gain adjustment mode selection] is set to "3" (manual mode).
- [Pr. PB02.0 Vibration suppression control 1 - Tuning mode selection] is set to "2" (manual setting).
- "1" (signal (CDP/C_CDP)) is selected in [Pr. PB26.0 Gain switching selection].

Switching gains during driving may cause a shock. Switch the gains after the servo motor has stopped.

[Pr. PB35_Gain switching - Vibration suppression control 1 - Vibration frequency damping (VRF13B)]

Initial value	Setting range	Setting method	Ver.
0.00	0.00 to 0.30	Each axis	A0

Set the damping of the vibration frequency for vibration suppression control 1 for when the gain switching is enabled.

This servo parameter is enabled in the following conditions:

- [Pr. PA08.0 Gain adjustment mode selection] is set to "3" (manual mode).
- [Pr. PB02.0 Vibration suppression control 1 - Tuning mode selection] is set to "2" (manual setting).
- "1" (signal (CDP/C_CDP)) is selected in [Pr. PB26.0 Gain switching selection].

Switching gains during driving may cause a shock. Switch the gains after the servo motor has stopped.

[Pr. PB36_Gain switching - Vibration suppression control 1 - Resonance frequency damping (VRF14B)]

Initial value	Setting range	Setting method	Ver.
0.00	0.00 to 0.30	Each axis	A0

Set the damping of the resonance frequency for vibration suppression control 1 for when the gain switching is enabled.

This servo parameter is enabled in the following conditions:

- [Pr. PA08.0 Gain adjustment mode selection] is set to "3" (manual mode).
- [Pr. PB02.0 Vibration suppression control 1 - Tuning mode selection] is set to "2" (manual setting).
- "1" (signal (CDP/C_CDP)) is selected in [Pr. PB26.0 Gain switching selection].

Switching gains during driving may cause a shock. Switch the gains after the servo motor has stopped.

[Pr. PB45_Command notch filter (CNHF)]

Initial value	Setting range	Setting method	Ver.
00000000h	Refer to the relevant detail No.	Each axis	Refer to the relevant detail No.

Set the command notch filter.

[Pr. PB45.0-1_Command notch filter setting frequency selection]

Initial value	Setting range	Ver.
00h	Refer to the text	A0

Refer to the following table for the relation of setting values to frequencies.

Setting value	Frequency [Hz]
00	Disabled
01	2000
02	1000
03	666
04	500
06	400
07	333
08	285
09	250
0A	222
0B	200
0C	181
0D	166
0F	153
10	142
11	133
12	125
13	117
14	111
15	105
16	100
17	95
19	90
1A	86
1B	83
1C	80
1D	76
1E	74
1F	71

Setting value	Frequency [Hz]
21	66
22	62
23	58
24	55
25	52
26	50
27	47
29	45
2A	43
2B	41
2C	40
2D	38
2E	37
2F	35
30	34.5
31	33.3
32	31.3
33	29.4
34	27.8
35	26.3
36	25.0
38	23.8
39	22.7
3A	21.7
3B	20.8
3C	20.0
3D	19.2
3E	18.5
3F	17.9
40	17.2
41	16.7
42	15.6
43	14.7
44	13.9
45	13.2
46	12.5
48	11.9
49	11.4
4A	10.9
4B	10.4
4C	10
4D	9.6
4E	9.3
4F	8.9
50	8.6
51	8.3
52	7.8
53	7.4
54	6.9
55	6.6
56	6.3
58	6.0
59	5.7

Setting value	Frequency [Hz]
5A	5.4
5B	5.2
5C	5.0
5D	4.8
5E	4.6
5F	4.5
60	4.31
61	4.17
62	3.91
63	3.68
64	3.47
65	3.29
66	3.13
68	2.98
69	2.84
6A	2.72
6B	2.60
6C	2.50
6D	2.40
6E	2.31
6F	2.23
71	2.08
72	1.95
73	1.84
74	1.74
75	1.64
76	1.56
78	1.49
79	1.42
7A	1.36
7B	1.30
7C	1.25
7D	1.20
7E	1.16
7F	1.12

[Pr. PB45.2_Notch depth selection]

Initial value	Setting range	Ver.
0h	Refer to the text	A0

Refer to the following table for details.

Setting value	Depth [dB]
0	-40.0
1	-24.1
2	-18.1
3	-14.5
4	-12.0
5	-10.1
6	-8.5
7	-7.2
8	-6.0
9	-5.0
A	-4.1
B	-3.3
C	-2.5
D	-1.8
E	-1.2
F	-0.6

[Pr. PB46_Machine resonance suppression filter 3 (NH3)]

Initial value	Setting range	Setting method	Ver.
4500 [Hz]	10 to 9000	Each axis	A0

Set the notch frequency of the machine resonance suppression filter 3.

When [Pr. PB47.0 Machine resonance suppression filter 3 selection] is set to "1" (enabled), set the notch frequency with this servo parameter.

[Pr. PB47_Notch shape selection 3 (NHQ3)]

Initial value	Setting range	Setting method	Ver.
00000000h	Refer to the relevant detail No.	Each axis	Refer to the relevant detail No.

Set forms of the machine resonance suppression filter 3.

[Pr. PB47.0_Machine resonance suppression filter 3 selection]

Initial value	Setting range	Ver.
0h	Refer to the text	A0

0: Disabled

1: Enabled

[Pr. PB47.1_Notch depth selection]

Initial value	Setting range	Ver.
0h	Refer to the text	A0

0: -40 dB

1: -14 dB

2: -8 dB

3: -4 dB

[Pr. PB47.2_Notch width selection]

Initial value	Setting range	Ver.
0h	Refer to the text	A0

0: $\alpha = 2$

1: $\alpha = 3$

2: $\alpha = 4$

3: $\alpha = 5$

[Pr. PB48_Machine resonance suppression filter 4 (NH4)]

Initial value	Setting range	Setting method	Ver.
4500 [Hz]	10 to 9000	Each axis	A0

Set the notch frequency of the machine resonance suppression filter 4.

When [Pr. PB49.0 Machine resonance suppression filter 4 selection] is set to "1" (enabled), set the notch frequency with this servo parameter.

[Pr. PB49_Notch shape selection 4 (NHQ4)]

Initial value	Setting range	Setting method	Ver.
0000000h	Refer to the relevant detail No.	Each axis	Refer to the relevant detail No.

Set forms of the machine resonance suppression filter 4.

[Pr. PB49.0_Machine resonance suppression filter 4 selection]

Initial value	Setting range	Ver.
0h	Refer to the text	A0

0: Disabled

1: Enabled

When this setting value is "Enabled", [Pr. PB17 Shaft resonance suppression filter] cannot be used.

[Pr. PB49.1_Notch depth selection]

Initial value	Setting range	Ver.
0h	Refer to the text	A0

0: -40 dB

1: -14 dB

2: -8 dB

3: -4 dB

[Pr. PB49.2_Notch width selection]

Initial value	Setting range	Ver.
0h	Refer to the text	A0

0: $\alpha = 2$

1: $\alpha = 3$

2: $\alpha = 4$

3: $\alpha = 5$

[Pr. PB50_Machine resonance suppression filter 5 (NH5)]

Initial value	Setting range	Setting method	Ver.
4500 [Hz]	10 to 9000	Each axis	A0

Set the notch frequency of the machine resonance suppression filter 5.

When [Pr. PB51.0 Machine resonance suppression filter 5 selection] is set to "1" (enabled), set the notch frequency with this servo parameter.

[Pr. PB51_Notch shape selection 5 (NHQ5)]

Initial value	Setting range	Setting method	Ver.
0000000h	Refer to the relevant detail No.	Each axis	Refer to the relevant detail No.

Set forms of the machine resonance suppression filter 5.

When [Pr. PA08.0 Gain adjustment mode selection] is set to "5" (quick tuning mode), the setting value of this servo parameter reflects the adjustment result of quick tuning.

When [Pr. PE41.0 Robust filter selection] is set to "1" (enabled), machine resonance suppression filter 5 cannot be used.

[Pr. PB51.0_Machine resonance suppression filter 5 selection]

Initial value	Setting range	Ver.
0h	Refer to the text	A0

0: Disabled

1: Enabled

[Pr. PB51.1_Notch depth selection]

Initial value	Setting range	Ver.
0h	Refer to the text	A0

0: -40 dB

1: -14 dB

2: -8 dB

3: -4 dB

[Pr. PB51.2_Notch width selection]

Initial value	Setting range	Ver.
0h	Refer to the text	A0

0: $\alpha = 2$

1: $\alpha = 3$

2: $\alpha = 4$

3: $\alpha = 5$

[Pr. PB52_Vibration suppression control 2 - Vibration frequency (VRF21)]

Initial value	Setting range	Setting method	Ver.
100.0 [Hz]	0.1 to 300.0	Each axis	A0

Set the vibration frequency of vibration suppression control 2 to suppress low-frequency machine vibration.

When "1" (automatic setting) is selected in [Pr. PB02.1 Vibration suppression control 2 - Tuning mode selection], this servo parameter will be set automatically. When "2" (manual setting) is selected, set the vibration frequency with this servo parameter.

The setting value is enabled when [Pr. PA24.0 Vibration suppression mode selection] is set to "1" (3 inertia mode).

The available range of [Pr. PB52 Vibration suppression control 2 - Vibration frequency] depends on the value in [Pr. PB07 Model control gain]. If the setting value of [Pr. PB52] exceeds the available range, the vibration suppression control is disabled.

[Pr. PB53_Vibration suppression control 2 - Resonance frequency (VRF22)]

Initial value	Setting range	Setting method	Ver.
100.0 [Hz]	0.1 to 300.0	Each axis	A0

Set the resonance frequency of vibration suppression control 2 to suppress low-frequency machine vibration.

When "1" (automatic setting) is selected in [Pr. PB02.1 Vibration suppression control 2 - Tuning mode selection], this servo parameter will be set automatically. When "2" (manual setting) is selected, set the resonance frequency with this servo parameter.

The setting value is enabled when [Pr. PA24.0 Vibration suppression mode selection] is set to "1" (3 inertia mode).

The available range of [Pr. PB53 Vibration suppression control 2 - Resonance frequency] changes depending on the value in [Pr. PB07 Model control gain]. If the setting value of [Pr. PB53] exceeds the available range, the vibration suppression control is disabled.

[Pr. PB54_Vibration suppression control 2 - Vibration frequency damping (VRF23)]

Initial value	Setting range	Setting method	Ver.
0.00	0.00 to 0.30	Each axis	A0

Set the damping of the vibration frequency for vibration suppression control 2 to suppress low-frequency machine vibration.

When "1" (automatic setting) is selected in [Pr. PB02.1 Vibration suppression control 2 - Tuning mode selection], this servo parameter will be set automatically. When "2" (manual setting) is selected, set the damping of the vibration frequency with this servo parameter.

The setting value is enabled when [Pr. PA24.0 Vibration suppression mode selection] is set to "1" (3 inertia mode).

[Pr. PB55_Vibration suppression control 2 - Resonance frequency damping (VRF24)]

Initial value	Setting range	Setting method	Ver.
0.00	0.00 to 0.30	Each axis	A0

Set the damping of the resonance frequency for vibration suppression control 2 to suppress low-frequency machine vibration.

When "1" (automatic setting) is selected in [Pr. PB02.1 Vibration suppression control 2 - Tuning mode selection], this servo parameter will be set automatically. When "2" (manual setting) is selected, set the damping of the resonance frequency with this servo parameter.

The setting value is enabled when [Pr. PA24.0 Vibration suppression mode selection] is set to "1" (3 inertia mode).

[Pr. PB56_Gain switching - Vibration suppression control 2 - Vibration frequency (VRF21B)]

Initial value	Setting range	Setting method	Ver.
0.0 [Hz]	0.0 to 300.0	Each axis	A0

Set the vibration frequency of vibration suppression control 2 for when the gain switching is enabled.

When the setting value of this servo parameter is less than "0.1", the setting value of [Pr. PB52 Vibration suppression control 2 - Vibration frequency] is applied.

This servo parameter is enabled in the following conditions:

- [Pr. PA08.0 Gain adjustment mode selection] is set to "3" (manual mode).
- [Pr. PA24.0 Vibration suppression mode selection] is set to "1" (3 inertia mode).
- [Pr. PB02.1 Vibration suppression control 2 - Tuning mode selection] is set to "2" (manual setting).
- "1" (signal (CDP/C_CDP)) is selected in [Pr. PB26.0 Gain switching selection].

Switching gains during driving may cause a shock. Switch the gains after the servo motor has stopped.

[Pr. PB57_Gain switching - Vibration suppression control 2 - Resonance frequency (VRF22B)]

Initial value	Setting range	Setting method	Ver.
0.0 [Hz]	0.0 to 300.0	Each axis	A0

Set the resonance frequency for vibration suppression control 2 for when the gain switching is enabled.

When the setting value of this servo parameter is less than "0.1", the setting value of [Pr. PB53 Vibration suppression control 2 - Resonance frequency] is applied.

This servo parameter is enabled in the following conditions:

- [Pr. PA08.0 Gain adjustment mode selection] is set to "3" (manual mode).
- [Pr. PA24.0 Vibration suppression mode selection] is set to "1" (3 inertia mode).
- [Pr. PB02.1 Vibration suppression control 2 - Tuning mode selection] is set to "2" (manual setting).
- "1" (signal (CDP/C_CDP)) is selected in [Pr. PB26.0 Gain switching selection].

Switching gains during driving may cause a shock. Switch the gains after the servo motor has stopped.

[Pr. PB58_Gain switching - Vibration suppression control 2 - Vibration frequency damping (VRF23B)]

Initial value	Setting range	Setting method	Ver.
0.00	0.00 to 0.30	Each axis	A0

Set the damping of the vibration frequency for vibration suppression control 2 for when the gain switching is enabled.

This servo parameter is enabled in the following conditions:

- [Pr. PA08.0 Gain adjustment mode selection] is set to "3" (manual mode).
- [Pr. PA24.0 Vibration suppression mode selection] is set to "1" (3 inertia mode).
- [Pr. PB02.1 Vibration suppression control 2 - Tuning mode selection] is set to "2" (manual setting).
- "1" (signal (CDP/C_CDP)) is selected in [Pr. PB26.0 Gain switching selection].

Switching gains during driving may cause a shock. Switch the gains after the servo motor has stopped.

[Pr. PB59_Gain switching - Vibration suppression control 2 - Resonance frequency damping (VRF24B)]

Initial value	Setting range	Setting method	Ver.
0.00	0.00 to 0.30	Each axis	A0

Set the damping of the resonance frequency for vibration suppression control 2 for when the gain switching is enabled.

This servo parameter is enabled in the following conditions:

- [Pr. PA08.0 Gain adjustment mode selection] is set to "3" (manual mode).
- [Pr. PA24.0 Vibration suppression mode selection] is set to "1" (3 inertia mode).
- [Pr. PB02.1 Vibration suppression control 2 - Tuning mode selection] is set to "2" (manual setting).
- "1" (signal (CDP/C_CDP)) is selected in [Pr. PB26.0 Gain switching selection].

[Pr. PB60_Gain switching - Model control gain (PG1B)]

Initial value	Setting range	Setting method	Ver.
0.0 [rad/s]	0.0 to 8000.0	Each axis	A0

Set the model control gain for when the gain switching is enabled.

When the setting value of this servo parameter is less than "1.0", the setting value of [Pr. PB07 Model control gain] is applied.

This servo parameter is enabled in the following conditions:

- [Pr. PA08.0 Gain adjustment mode selection] is set to "3" (manual mode).
- "1" (signal (CDP/C_CDP)) is selected in [Pr. PB26.0 Gain switching selection].

Switching gains during driving may cause a shock. Switch the gains after the servo motor has stopped.

[Pr. PB65_Gain switching 2 condition (CDL2)]

Initial value	Setting range	Setting method	Ver.
10 [Refer to the text below for the unit.]	0 to 16777215	Each axis	A0

Set the value of the gain switching (command frequency, droop pulses, or servo motor speed) selected in [Pr. PB26.0 Gain switching selection].

The set value unit differs depending on the switching condition item. The units are as follows: [kpulse/s] for command frequency, [pulse] for droop pulses, and [r/min] for servo motor speed.

If using a linear servo motor, the unit of the servo motor speed is [mm/s].

The setting value is to be larger than in [Pr. PB27 Gain switching condition].

When the setting value of this servo parameter is "0", the gain is not switched to the gain switching 2.

[Pr. PB66_Gain switching 2 time constant (CDT2)]

Initial value	Setting range	Setting method	Ver.
1 [ms]	0 to 100	Each axis	A0

Set the time constant until the gain switches from "gain at normal use" or "gain at switching" to "gain at switching 2" in response to the conditions set in [Pr. PB26 Gain switching function] and [Pr. PB65 Gain switching 2 condition].

[Pr. PB67_Gain switching 2 - Load to motor inertia ratio/load to motor mass ratio (GD2C)]

Initial value	Setting range	Setting method	Ver.
7.00 [times]	0.00 to 300.00	Each axis	A0

Set the load to motor inertia ratio/load to motor mass ratio for when the gain switching 2 is enabled.

This servo parameter is enabled when [Pr. PA08.0 Gain adjustment mode selection] is set to "3" (manual mode).

[Pr. PB68_Gain switching 2 - Position control gain (PG2C)]

Initial value	Setting range	Setting method	Ver.
0.0 [rad/s]	0.0 to 2000.0	Each axis	A0

Set the position control gain for when the gain switching 2 is enabled.

When the setting value of this servo parameter is less than "1.0", the setting value of [Pr. PB08 Position control gain] is applied.

This servo parameter is enabled when [Pr. PA08.0 Gain adjustment mode selection] is set to "3" (manual mode).

[Pr. PB69_Gain switching 2 - Speed control gain (VG2C)]

Initial value	Setting range	Setting method	Ver.
0 [rad/s]	0 to 65535	Each axis	A0

Set the speed control gain for when the gain switching 2 is enabled.

When the setting value of this servo parameter is less than "20", the setting value of [Pr. PB09 Speed control gain] is applied.

This servo parameter is enabled when [Pr. PA08.0 Gain adjustment mode selection] is set to "3" (manual mode).

[Pr. PB70_Gain switching 2 - Speed integral compensation (VICC)]

Initial value	Setting range	Setting method	Ver.
0.0 [ms]	0.0 to 5000.0	Each axis	A0

Set the speed integral compensation for when the gain switching 2 is enabled.

When the setting value of this servo parameter is less than "0.1", the setting value of [Pr. PB10 Speed integral compensation] is applied.

This servo parameter is enabled when [Pr. PA08.0 Gain adjustment mode selection] is set to "3" (manual mode).

[Pr. PB71_Gain switching 2 - Vibration suppression control 1 - Vibration frequency (VRF11C)]

Initial value	Setting range	Setting method	Ver.
0.0 [Hz]	0.0 to 300.0	Each axis	A0

Set the vibration frequency of vibration suppression control 1 for when the gain switching 2 is enabled.

When the setting value of this servo parameter is less than "0.1", the setting value of [Pr. PB19 Vibration suppression control 1 - Vibration frequency] is applied.

This servo parameter is enabled in the following conditions:

- [Pr. PA08.0 Gain adjustment mode selection] is set to "3" (manual mode).
- [Pr. PB02.0 Vibration suppression control 1 - Tuning mode selection] is set to "2" (manual setting).
- [Pr. PB26.0 Gain switching selection] is set to "1" (signal (CDP/C_CDP)) while [Pr. PB26.4 Gain switching 2 selection] is set to "2" (the same condition as [Pr. PB26.0 Gain switching selection]), or [Pr. PB26.4] is set to "1" (signal (CDP2/C_CDP2)).

Switching gains during driving may cause a shock. Switch the gains after the servo motor has stopped.

[Pr. PB72_Gain switching 2 - Vibration suppression control 1 - Resonance frequency (VRF12C)]

Initial value	Setting range	Setting method	Ver.
0.0 [Hz]	0.0 to 300.0	Each axis	A0

Set the resonance frequency for vibration suppression control 1 for when the gain switching 2 is enabled.

When the setting value of this servo parameter is less than "0.1", the setting value of [Pr. PB20 Vibration suppression control 1 - Resonance frequency] is applied.

This servo parameter is enabled in the following conditions:

- [Pr. PA08.0 Gain adjustment mode selection] is set to "3" (manual mode).
- [Pr. PB02.0 Vibration suppression control 1 - Tuning mode selection] is set to "2" (manual setting).
- [Pr. PB26.0 Gain switching selection] is set to "1" (signal (CDP/C_CDP)) while [Pr. PB26.4 Gain switching 2 selection] is set to "2" (the same condition as [Pr. PB26.0 Gain switching selection]), or [Pr. PB26.4] is set to "1" (signal (CDP2/C_CDP2)).

Switching gains during driving may cause a shock. Switch the gains after the servo motor has stopped.

[Pr. PB73_Gain switching 2 - Vibration suppression control 1 - Vibration frequency damping (VRF13C)]

Initial value	Setting range	Setting method	Ver.
0.00	0.00 to 0.30	Each axis	A0

Set the damping of the vibration frequency for vibration suppression control 1 for when the gain switching is enabled.

This servo parameter is enabled in the following conditions:

- [Pr. PA08.0 Gain adjustment mode selection] is set to "3" (manual mode).
- [Pr. PB02.0 Vibration suppression control 1 - Tuning mode selection] is set to "2" (manual setting).
- [Pr. PB26.0 Gain switching selection] is set to "1" (signal (CDP/C_CDP)) while [Pr. PB26.4 Gain switching 2 selection] is set to "2" (the same condition as [Pr. PB26.0 Gain switching selection]), or [Pr. PB26.4] is set to "1" (signal (CDP2/C_CDP2)).

Switching gains during driving may cause a shock. Switch the gains after the servo motor has stopped.

[Pr. PB74_Gain switching 2 - Vibration suppression control 1 - Resonance frequency damping (VRF14C)]

Initial value	Setting range	Setting method	Ver.
0.00	0.00 to 0.30	Each axis	A0

Set the damping of the resonance frequency for vibration suppression control 1 for when the gain switching is enabled.

This servo parameter is enabled in the following conditions:

- [Pr. PA08.0 Gain adjustment mode selection] is set to "3" (manual mode).
- [Pr. PB02.0 Vibration suppression control 1 - Tuning mode selection] is set to "2" (manual setting).
- [Pr. PB26.0 Gain switching selection] is set to "1" (signal (CDP/C_CDP)) while [Pr. PB26.4 Gain switching 2 selection] is set to "2" (the same condition as [Pr. PB26.0 Gain switching selection]), or [Pr. PB26.4] is set to "1" (signal (CDP2/C_CDP2)).

Switching gains during driving may cause a shock. Switch the gains after the servo motor has stopped.

[Pr. PB75_Gain switching 2 - Vibration suppression control 2 - Vibration frequency (VRF21C)]

Initial value	Setting range	Setting method	Ver.
0.0 [Hz]	0.0 to 300.0	Each axis	A0

Set the vibration frequency of vibration suppression control 2 for when the gain switching is enabled.

When the setting value of this servo parameter is less than "0.1", the setting value of [Pr. PB52 Vibration suppression control 2 - Vibration frequency] is applied.

This servo parameter is enabled in the following conditions:

- [Pr. PA08.0 Gain adjustment mode selection] is set to "3" (manual mode).
- [Pr. PA24.0 Vibration suppression mode selection] is set to "1" (3 inertia mode).
- [Pr. PB02.1 Vibration suppression control 2 - Tuning mode selection] is set to "2" (manual setting).
- [Pr. PB26.0 Gain switching selection] is set to "1" (signal (CDP/C_CDP)) while [Pr. PB26.4 Gain switching 2 selection] is set to "2" (the same condition as [Pr. PB26.0 Gain switching selection]), or [Pr. PB26.4] is set to "1" (signal (CDP2/C_CDP2)).

Switching gains during driving may cause a shock. Switch the gains after the servo motor has stopped.

[Pr. PB76_Gain switching 2 - Vibration suppression control 2 - Resonance frequency (VRF22C)]

Initial value	Setting range	Setting method	Ver.
0.0 [Hz]	0.0 to 300.0	Each axis	A0

Set the resonance frequency for vibration suppression control 2 for when the gain switching is enabled.

When the setting value of this servo parameter is less than "0.1", the setting value of [Pr. PB53 Vibration suppression control 2 - Resonance frequency] is applied.

This servo parameter is enabled in the following conditions:

- [Pr. PA08.0 Gain adjustment mode selection] is set to "3" (manual mode).
- [Pr. PA24.0 Vibration suppression mode selection] is set to "1" (3 inertia mode).
- [Pr. PB02.1 Vibration suppression control 2 - Tuning mode selection] is set to "2" (manual setting).
- [Pr. PB26.0 Gain switching selection] is set to "1" (signal (CDP/C_CDP)) while [Pr. PB26.4 Gain switching 2 selection] is set to "2" (the same condition as [Pr. PB26.0 Gain switching selection]), or [Pr. PB26.4] is set to "1" (signal (CDP2/C_CDP2)).

Switching gains during driving may cause a shock. Switch the gains after the servo motor has stopped.

[Pr. PB77_Gain switching 2 - Vibration suppression control 2 - Vibration frequency damping (VRF23C)]

Initial value	Setting range	Setting method	Ver.
0.00	0.00 to 0.30	Each axis	A0

Set the damping of the vibration frequency for vibration suppression control 2 for when the gain switching is enabled.

This servo parameter is enabled in the following conditions:

- [Pr. PA08.0 Gain adjustment mode selection] is set to "3" (manual mode).
- [Pr. PA24.0 Vibration suppression mode selection] is set to "1" (3 inertia mode).
- [Pr. PB02.1 Vibration suppression control 2 - Tuning mode selection] is set to "2" (manual setting).
- [Pr. PB26.0 Gain switching selection] is set to "1" (signal (CDP/C_CDP)) while [Pr. PB26.4 Gain switching 2 selection] is set to "2" (the same condition as [Pr. PB26.0 Gain switching selection]), or [Pr. PB26.4] is set to "1" (signal (CDP2/C_CDP2)).

Switching gains during driving may cause a shock. Switch the gains after the servo motor has stopped.

[Pr. PB78_Gain switching 2 - Vibration suppression control 2 - Resonance frequency damping (VRF24C)]

Initial value	Setting range	Setting method	Ver.
0.00	0.00 to 0.30	Each axis	A0

Set the damping of the resonance frequency for vibration suppression control 2 for when the gain switching is enabled.

This servo parameter is enabled in the following conditions:

- [Pr. PA08.0 Gain adjustment mode selection] is set to "3" (manual mode).
- [Pr. PA24.0 Vibration suppression mode selection] is set to "1" (3 inertia mode).
- [Pr. PB02.1 Vibration suppression control 2 - Tuning mode selection] is set to "2" (manual setting).
- [Pr. PB26.0 Gain switching selection] is set to "1" (signal (CDP/C_CDP)) while [Pr. PB26.4 Gain switching 2 selection] is set to "2" (the same condition as [Pr. PB26.0 Gain switching selection]), or [Pr. PB26.4] is set to "1" (signal (CDP2/C_CDP2)).

Switching gains during driving may cause a shock. Switch the gains after the servo motor has stopped.

[Pr. PB79_Gain switching 2 - Model control gain (PG1C)]

Initial value	Setting range	Setting method	Ver.
0.0 [rad/s]	0.0 to 8000.0	Each axis	A0

Set the model control gain for when the gain switching is enabled.

When the setting value of this servo parameter is less than "1.0", the setting value of [Pr. PB07 Model control gain] is applied. This servo parameter is enabled in the following conditions:

- [Pr. PB26.0 Gain switching selection] is set to "1" (signal (CDP/C_CDP)) while [Pr. PB26.4 Gain switching 2 selection] is set to "2" (the same condition as [Pr. PB26.0 Gain switching selection]), or [Pr. PB26.4] is set to "1" (signal (CDP2/C_CDP2)).

[Pr. PB81_Command filter (*CFIL)]

Initial value	Setting range	Setting method	Ver.
00000001h	Refer to the relevant detail No.	Each axis	Refer to the relevant detail No.

[Pr. PB81.4_Position command smoothing filter]

Initial value	Setting range	Ver.
0h	Refer to the text	A5

This function can be used only in position mode and positioning mode.

This filter and [Pr. PB45 Command notch filter] are mutually exclusive. "1" (enabled) can be set in this function only when [Pr. PB45.0-1 Command notch filter setting frequency selection] is set to "00" (disabled). When a setting value other than "00" (disabled) is set in [Pr. PB45.0-1], the filter is disabled regardless of the setting value.

0: Disabled

1: Enabled

When "1" (enabled) is selected, set the filter time constant with [Pr. PB82 Position command smoothing filter time constant].

[Pr. PB82_Position command smoothing filter time constant (PFT)]

Initial value	Setting range	Setting method	Ver.
0.0 [ms]	0.0 to 100.0	Each axis	A5

Set the position command smoothing filter time constant.

This servo parameter can be used when [Pr. PB81.4 Position command smoothing filter] is set to "1" (enabled).

When [Pr. PA01.7 High-speed mode selection] is set to "1" (enabled), values exceeding 50 [ms] are clamped to 50 [ms].

1.4 Extension setting servo parameters group ([Pr. PC_ _])

[Pr. PC01_ Excessive error alarm trigger level (ERZ)]

Initial value	Setting range	Setting method	Ver.
0 [rev], [mm]	0 to 1000	Each axis	A0

Set an excessive error alarm trigger level.

If using a rotary servo motor or direct drive motor, set the level in units of rev. If 200 rev or higher is set, the value will be clamped to 200 rev.

If using a linear servo motor, set the level in units of mm.

When the value is set to "0", the alarm trigger level for rotary servo motors and direct drive motors is 3 rev. The alarm trigger level for linear servo motors is 100 mm.

The unit can be changed with [Pr. PC06.3 Excessive error alarm trigger level/excessive error warning trigger level - Unit selection].

[Pr. PC02_ Electromagnetic brake sequence output (MBR)]

Initial value	Setting range	Setting method	Ver.
0 [ms]	0 to 1000	Each axis	A0

Set the delay time used between the MBR (Electromagnetic brake interlock) shut-off and the base circuit shut-off.

[Pr. PC03_ Encoder output pulses selection (*ENRS)]







Initial value	Setting range	Setting method	Ver.
00000000h	Refer to the relevant detail No.	Each axis	Refer to the relevant detail No.

[Pr. PC03.0_ Encoder output pulse - Phase selection]

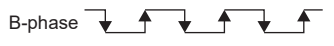
Initial value	Setting range	Ver.
0h	Refer to the text	A0

0: Increasing A-phase 90° in CCW or positive direction

1: Increasing A-phase 90° in CW or negative direction

Setting value	Servo motor rotation direction/linear servo motor travel direction	
	CCW or positive direction	CW or negative direction
0	A-phase  B-phase 	A-phase  B-phase 
1	A-phase  B-phase 	A-phase  B-phase 

This servo parameter is not available for the MR-J5-_G_-LL servo amplifier.

[Pr. PC03.1_Encoder output pulse setting selection]

Initial value	Setting range	Ver.
0h	Refer to the text	A0

Select the encoder output pulse setting.

This servo parameter cannot be set for C-axis.

If this servo parameter is set to "0" while [Pr. PC03.2 Encoder selection for encoder output pulse] is set to "1", [AL. 037 Parameter error] occurs.

When an encoder other than an A/B/Z-phase differential output type encoder is connected, setting this servo parameter to "4" causes [AL. 037] to occur.

0: Output pulse setting

1: Dividing ratio setting

3: A-phase/B-phase pulse electronic gear setting

4: A/B-phase pulse through output setting

■Settings of [Pr. PC03.1] and [Pr. PC03.2]

- When [Pr. PC03.2] = "0" (servo motor-side encoder)

Setting value of [Pr. PC03.1]	For rotary servo motors and direct drive motors	For linear servo motors
"0" (output pulse setting)	Set the output pulses per revolution with [Pr. PA15 Encoder output pulses]. If [Pr. PC03.2] is set to "1" (load-side encoder), [AL. 037] will occur. Output pulse = Setting value of [Pr. PA15] [pulse/rev]	The output pulse setting cannot be used. When "0" is set, the condition is the same as when "1" is set.
"1" (dividing ratio setting)	Set the dividing ratio relative to the resolution per servo motor revolution with [Pr. PA15]. Output pulse = $\frac{\text{Resolution per revolution}}{\text{Setting value of [Pr. PA15]}}$ [pulse/rev]	Set the dividing ratio relative to the travel distance of the linear servo motor with [Pr. PA15]. Output pulse = $\frac{\text{Travel distance of linear servo motor}}{\text{Setting value of [Pr. PA15]}}$ [pulse]
"3" (A-phase/B-phase pulse electronic gear setting)	Set the A-phase/B-phase pulse electronic gear with [Pr. PA15] and [Pr. PA16 Encoder output pulses 2]. Output pulse = $\frac{\text{Setting value of [Pr. PA15]}}{\text{Resolution per revolution} \times \text{Setting value of [Pr. PA16]}}$ [pulse/rev]	Set the A-phase/B-phase pulse electronic gear with [Pr. PA15] and [Pr. PA16 Encoder output pulses 2]. Output pulse = $\frac{\text{Setting value of [Pr. PA15]}}{\text{Travel distance of linear servo motor} \times \text{Setting value of [Pr. PA16]}}$ [pulse]
"4" (A/B-phase pulse through output setting) *1	<ul style="list-style-type: none"> • When a servo amplifier with a firmware version earlier than B2 is being used, [AL. 037] occurs. • A/B-phase pulses are output when an A/B/Z-phase differential output type encoder is used. If a different encoder is connected, [AL. 037] occurs. • The setting value in [Pr. PC03.0 Encoder output pulse - Phase selection] is not applied. • The setting values in [Pr. PA15] and [Pr. PA16] are not applied. Output pulse = A/B-phase pulse of A/B/Z-phase differential output type encoder [pulse]	<ul style="list-style-type: none"> • A/B-phase pulses are output when an A/B/Z-phase differential output type encoder is used. If a different encoder is connected, [AL. 037] occurs. • The setting value in [Pr. PC03.0 Encoder output pulse - Phase selection] is not applied. • The setting values in [Pr. PA15] and [Pr. PA16] are not applied. Output pulse = A/B-phase pulse of A/B/Z-phase differential output type encoder [pulse]

*1 If this value is set when using the rotary servo motor, [AL. 037] occurs.

- When [Pr. PC03.2] = "1" (load-side encoder)

Setting value of [Pr. PC03.1]	When in the fully closed loop control mode	When the scale measurement function is enabled
"0" (output pulse setting)	[AL. 037] occurs.	
"1" (dividing ratio setting)	Set the dividing ratio relative to the resolution per servo motor revolution with [Pr. PA15]. $\text{Output pulse} = \frac{\text{Resolution per revolution}}{\text{Setting value of [Pr. PA15]}} \text{ [pulse/rev]}$	Set the dividing ratio relative to the travel distance of the scale measurement encoder with [Pr. PA15]. $\text{Output pulse} = \frac{\text{Travel distance of scale measurement encoder}}{\text{Setting value of [Pr. PA15]}} \text{ [pulse]}$
"3" (A-phase/B-phase pulse electronic gear setting)	Set the A-phase/B-phase pulse electronic gear with [Pr. PA15] and [Pr. PA16]. $\text{Output pulse} = \frac{\text{Resolution per revolution} \times \text{Setting value of [Pr. PA15]}}{\text{Setting value of [Pr. PA16]}} \text{ [pulse/rev]}$	Set the A-phase/B-phase pulse electronic gear with [Pr. PA15] and [Pr. PA16]. $\text{Output pulse} = \frac{\text{Travel distance of scale measurement encoder} \times \text{Setting value of [Pr. PA15]}}{\text{Setting value of [Pr. PA16]}} \text{ [pulse]}$
"4" (A/B-phase pulse through output setting)	<ul style="list-style-type: none"> • A/B-phase pulses are output when an A/B/Z-phase differential output type encoder is used. If a different encoder is connected, [AL. 037] occurs. • The setting value in [Pr. PC03.0 Encoder output pulse - Phase selection] is not applied. • The setting values in [Pr. PA15] and [Pr. PA16] are not applied. Output pulse = A/B-phase pulse of A/B/Z-phase differential output type encoder [pulse]	<ul style="list-style-type: none"> • A/B-phase pulses are output when an A/B/Z-phase differential output type encoder is used. If a different encoder is connected, [AL. 037] occurs. • A/B/Z-phase differential output type encoders cannot be used in the linear servo motor control mode or the direct drive motor control mode. • The setting value in [Pr. PC03.0 Encoder output pulse - Phase selection] is not applied. • The setting values in [Pr. PA15] and [Pr. PA16] are not applied. Output pulse = A/B-phase pulse of A/B/Z-phase differential output type encoder [pulse]

This servo parameter is not available for the MR-J5-_G_-LL servo amplifier.

[Pr. PC03.2_ Encoder selection for encoder output pulse]

Initial value	Setting range	Ver.
0h	Refer to the text	A0

Select the encoder that the servo amplifier will use to output encoder output pulses.

This servo parameter can be used only in a fully closed loop system.

If "1" is selected for systems other than a fully closed loop system or a semi closed loop system (scale measurement function enabled), [AL. 037 Parameter error] occurs.

This servo parameter cannot be set for the C-axis of multi-axis servo amplifiers.

For the settings, refer to the table for [Pr. PC03.1].

 Page 74 [Pr. PC03.1_ Encoder output pulse setting selection]

0: Servo motor-side encoder

1: Load-side encoder

This servo parameter is not available for the MR-J5-_G_-LL servo amplifier.

[Pr. PC04_Function selection C-1 (**COP1)]

Initial value	Setting range	Setting method	Ver.
00000000h	Refer to the relevant detail No.	Each axis	Refer to the relevant detail No.

[Pr. PC04.3_Encoder cable communication method selection]

Initial value	Setting range	Ver.
0h	Refer to the text	A0

0: Two-wire type

1: Four-wire type

When using an A/B/Z-phase differential output type encoder, set "0". Setting "1" triggers [AL. 037 Parameter error].

If the value is set incorrectly, [AL. 016 Encoder initial communication error 1] or [AL. 020 Encoder normal communication error 1] occurs.

For servo amplifiers other than the MR-J5-_G_-RJ and MR-J5-_G_-HS_, [AL. 037] occurs if this servo parameter is set to "1" while [Pr. PA01.4 Fully closed loop operation mode selection] is set to "1" (enabled (fully closed loop control mode)).

[Pr. PC05_Function selection C-2 (**COP2)]

Initial value	Setting range	Setting method	Ver.
00000000h	Refer to the relevant detail No.	Each axis	Refer to the relevant detail No.

[Pr. PC05.0_Motor-less operation selection]

Initial value	Setting range	Ver.
0h	Refer to the text	A0

Enable or disable motor-less operation. This operation can be used only in semi closed loop control while a rotary servo motor is used.

0: Disabled

1: Enabled

[Pr. PC05.4_Encoder communication circuit diagnosis mode selection]

Initial value	Setting range	Ver.
0h	Refer to the text	A0

Enable or disable the encoder communication circuit diagnosis mode.

[AL. 118.1 Encoder communication circuit diagnosis in progress] occurs during the encoder communication circuit diagnosis mode.

0: Encoder communication circuit diagnosis mode disabled

1: Encoder communication circuit diagnosis mode enabled

[Pr. PC06_Function selection C-3 (*COP3)]

Initial value	Setting range	Setting method	Ver.
00000000h	Refer to the relevant detail No.	Each axis	Refer to the relevant detail No.

[Pr. PC06.0_In-position range unit selection]

Initial value	Setting range	Ver.
0h	Refer to the text	A0

Select a unit of the in-position range.

If [Pr. PA01.4 Fully closed loop operation mode selection] is set to "1" (fully closed loop system), the in-position range is in the load-side encoder pulse unit.

This servo parameter is enabled only in the position mode and positioning mode.

0: Command input pulse unit

1: Servo motor encoder pulse unit

[Pr. PC06.3_Excessive error alarm trigger level/excessive error warning trigger level - Unit selection]

Initial value	Setting range	Ver.
0h	Refer to the text	A0

Select the unit used when setting the excessive error alarm trigger level in [Pr. PC01 Excessive error alarm trigger level] and setting the excessive error warning trigger level in [Pr. PC38 Excessive error warning trigger level].

This servo parameter is enabled only in the position mode and positioning mode.

0: [rev] or [mm]

1: [0.1 rev] or [0.1 mm]

2: [0.01 rev] or [0.01 mm]

3: [0.001 rev] or [0.001 mm]

[Pr. PC07_Zero speed (ZSP)]

Initial value	Setting range	Setting method	Ver.
50 [r/min], [mm/s]	0 to 10000	Each axis	A0

Set an output range of the zero speed signal (ZSP).

The zero speed signal detection has a hysteresis of 20 [r/min] (20 [mm/s]).

[Pr. PC08_Overspeed alarm detection level (OSL)]

Initial value	Setting range	Setting method	Ver.
0 [r/min], [mm/s]	0 to 20000	Each axis	A0

Set an overspeed alarm detection level.

When a value exceeding "servo motor maximum speed × 120 %" is set, the value will be clamped at "servo motor maximum speed × 120 %".

When "0" is set, the value of "servo motor maximum speed × 120 %" will be set.

When HK series servo motor is connected, the value of "servo motor maximum speed × 105 %" will be set.

[Pr. PC09_Analog monitor 1 output (MOD1)]

Initial value	Setting range	Setting method	Ver.
00000000h	Refer to the relevant detail No.	Common	Refer to the relevant detail No.

[Pr. PC09.0-1_Analog monitor 1 output selection]

Initial value	Setting range	Ver.
00h	Refer to the text	A0

Select the signal to be output to analog monitor 1.

Setting value	Explanation	Semi closed loop system *1			Fully closed loop system *1	
		Rotary	Linear	DD	Rotary	DD
00	Servo motor speed (± 8 V/max. speed)	<input type="radio"/>	<input type="radio"/>	<input type="radio"/>	<input type="radio"/>	<input type="radio"/>
01	Torque or thrust (± 8 V/max. torque or max. thrust) *3	<input type="radio"/>	<input type="radio"/>	<input type="radio"/>	<input type="radio"/>	<input type="radio"/>
02	Servo motor speed (+8 V/max. speed)	<input type="radio"/>	<input type="radio"/>	<input type="radio"/>	<input type="radio"/>	<input type="radio"/>
03	Torque or thrust (+8 V/max. torque or max. thrust) *3	<input type="radio"/>	<input type="radio"/>	<input type="radio"/>	<input type="radio"/>	<input type="radio"/>
04	Current command (± 8 V/max. current command)	<input type="radio"/>	<input type="radio"/>	<input type="radio"/>	<input type="radio"/>	<input type="radio"/>
05	Speed command (± 8 V/max. speed)	<input type="radio"/>	<input type="radio"/>	<input type="radio"/>	<input type="radio"/>	<input type="radio"/>
06	Servo motor-side droop pulses (± 10 V/100 pulses) *2	<input type="radio"/>	<input type="radio"/>	<input type="radio"/>	<input type="radio"/>	<input type="radio"/>
07	Servo motor-side droop pulses (± 10 V/1000 pulses) *2	<input type="radio"/>	<input type="radio"/>	<input type="radio"/>	<input type="radio"/>	<input type="radio"/>
08	Servo motor-side droop pulses (± 10 V/10000 pulses) *2	<input type="radio"/>	<input type="radio"/>	<input type="radio"/>	<input type="radio"/>	<input type="radio"/>
09	Servo motor-side droop pulses (± 10 V/100000 pulses) *2	<input type="radio"/>	<input type="radio"/>	<input type="radio"/>	<input type="radio"/>	<input type="radio"/>
0D	Bus voltage (200 V class: +8 V/400 V, 400 V class: +8 V/800 V)	<input type="radio"/>	<input type="radio"/>	<input type="radio"/>	<input type="radio"/>	<input type="radio"/>
0E	Speed command 2 (± 8 V/max. speed)	<input type="radio"/>	<input type="radio"/>	<input type="radio"/>	<input type="radio"/>	<input type="radio"/>
10 *4	Load-side droop pulses (± 10 V/100 pulses) *2	—	—	—	<input type="radio"/>	<input type="radio"/>
11 *4	Load-side droop pulses (± 10 V/1000 pulses) *2	—	—	—	<input type="radio"/>	<input type="radio"/>
12 *4	Load-side droop pulses (± 10 V/10000 pulses) *2	—	—	—	<input type="radio"/>	<input type="radio"/>
13 *4	Load-side droop pulses (± 10 V/100000 pulses) *2	—	—	—	<input type="radio"/>	<input type="radio"/>
14 *4	Load-side droop pulses (± 10 V/1 Mpulses) *2	—	—	—	<input type="radio"/>	<input type="radio"/>
15 *4	Motor/load side position deviation (± 10 V/100000 pulses)	—	—	—	<input type="radio"/>	<input type="radio"/>
16 *4	Motor/load side speed deviation (± 8 V/max. speed)	—	—	—	<input type="radio"/>	<input type="radio"/>
17	Internal temperature of encoder (± 10 V/ ± 128 °C)	<input type="radio"/>	—	<input type="radio"/>	<input type="radio"/>	<input type="radio"/>
18	Servo motor-side droop pulses (± 10 V/1 Mpulses) *2	<input type="radio"/>	<input type="radio"/>	<input type="radio"/>	<input type="radio"/>	<input type="radio"/>
1C	Pressure command (± 10 V/Setting value of [Pr. PW22]) *5	<input type="radio"/>	<input type="radio"/>	—	—	—
1D	Pressure feedback voltage (± 10 V/Pressure feedback voltage (± 11 V)) *5*6	<input type="radio"/>	<input type="radio"/>	—	—	—
1E	Analog monitor input 1 voltage (± 10 V/Analog monitor input 1 voltage (± 11 V)) *5*7	<input type="radio"/>	<input type="radio"/>	—	—	—
1F	Analog monitor input 2 voltage (± 10 V/Analog monitor input 2 voltage (± 11 V)) *5*8	<input type="radio"/>	<input type="radio"/>	—	—	—

*1 Items with are available for each operation mode.

Rotary: When rotary servo motors are used.

Linear: When linear servo motors are used.

DD: When direct drive motors are used.

*2 This is in the units of encoder pulses.

*3 The maximum torque or maximum thrust is enabled by the setting of [Pr. PA11 Forward rotation torque limit] or [Pr. PA12 Reverse rotation torque limit], whichever is larger.

*4 Available on servo amplifiers with firmware version A5 or later.

*5 Available only on the MR-J5- _G_-LL servo amplifier. The MR-J5- _G_-servo amplifier outputs "0".

*6 The result adjusted by [Pr. PW21 Pressure control feedback offset] is output.

*7 The result adjusted by [Pr. PW23 Analog monitor input 1 offset] is output.

*8 The result adjusted by [Pr. PW25 Analog monitor input 2 offset] is output.

[Pr. PC09.3_Analog monitor 1 output axis selection]

Initial value	Setting range	Ver.
0h	Refer to the text	A0

0: A-axis

1: B-axis

2: C-axis

[Pr. PC10_Analog monitor 2 output (MOD2)]

Initial value	Setting range	Setting method	Ver.
00000001h	Refer to the relevant detail No.	Common	Refer to the relevant detail No.

[Pr. PC10.0-1_Analog monitor 2 output selection]

Initial value	Setting range	Ver.
01h	Refer to the text	A0

Select the signal to be output to analog monitor 2.

Refer to the following for details of setting values.

☞ Page 78 [Pr. PC09_Analog monitor 1 output (MOD1)]

[Pr. PC10.3_Analog monitor 2 output axis selection]

Initial value	Setting range	Ver.
0h	Refer to the text	A0

0: A-axis

1: B-axis

2: C-axis

[Pr. PC11_Analog monitor 1 offset (MO1)]

Initial value	Setting range	Setting method	Ver.
0 [mV]	-999 to 999	Common	A0

Set the offset voltage of MO1 (Analog monitor 1).

[Pr. PC12_Analog monitor 2 offset (MO2)]

Initial value	Setting range	Setting method	Ver.
0 [mV]	-999 to 999	Common	A0

Set the offset voltage of MO2 (Analog monitor 2).

[Pr. PC16_Function selection C-3A (*COP3A)]

Initial value	Setting range	Setting method	Ver.
00000000h	Refer to the relevant detail No.	Each axis	Refer to the relevant detail No.

[Pr. PC16.4_Servo motor incorrect wiring detection function selection]

Initial value	Setting range	Ver.
0h	Refer to the text	A0

Set the servo motor incorrect wiring detection function to either enabled or disabled.

Setting this servo parameter to "1" on the MR-J5D_-_G_, MR-J5-_G_-RJ_, or MR-J5-_G_-HS_ triggers [AL. 037 Parameter error].

0: Servo motor incorrect wiring detection disabled

1: Servo motor incorrect wiring detection enabled

[Pr. PC16.5_Servo motor incorrect wiring detection function execution method selection]

Initial value	Setting range	Ver.
0h	Refer to the text	A0

Set the execution method for the servo motor incorrect wiring detection function.

0: Detect servo motor incorrect wiring at initial servo-on after enabling servo motor incorrect wiring detection

1: Detect servo motor incorrect wiring at initial servo-on after cycling the power

When [Pr. PC16.4] is set to "0" (servo motor incorrect wiring detection disabled), the servo motor incorrect wiring detection function is not executed regardless of the setting value in this servo parameter.

When this servo parameter is set to "0", servo motor incorrect wiring detection is executed at initial servo-on, and then after the detection is completed, [Pr. PC16.4] will be set to "0" (disabled).

[Pr. PC17_Function selection C-4 (**COP4)]

Initial value	Setting range	Setting method	Ver.
00000000h	Refer to the relevant detail No.	Each axis	Refer to the relevant detail No.

[Pr. PC17.1_Linear encoder multipoint Z-phase input function selection]

Initial value	Setting range	Ver.
0h	Refer to the text	A0

When multiple reference marks exist during the full stroke of the linear encoder, set "1".

0: Disabled

1: Enabled

[Pr. PC19_Function selection C-6 (*COP6)]

Initial value	Setting range	Setting method	Ver.
00000000h	Refer to the relevant detail No.	Each axis	Refer to the relevant detail No.

[Pr. PC19.0_[AL. 099 Stroke limit warning] selection]

Initial value	Setting range	Ver.
0h	Refer to the text	A0

Enable or disable [AL. 099 Stroke limit warning].

When "Disabled" is selected, [AL. 099] does not occur while LSP (Forward rotation stroke end) or LSN (Reverse rotation stroke end) is off, but the operation will be stopped with the stroke limit.

0: Enabled

1: Disabled

[Pr. PC19.4_Output open-phase detection selection]

Initial value	Setting range	Ver.
0h	Refer to the text	A0

Enable or disable the detection of output open-phase detection function.

0: Disabled

1: Enabled ([Pr. PC96 Output open-phase detection time] disabled)

2: Enabled ([Pr. PC96 Output open-phase detection time] enabled)

When "2" (enabled ([Pr. PC96 Output open-phase detection time] enabled)) is set, the setting value of [Pr. PC96 Output open-phase detection time] is the detection time of [AL. 139 Open-phase error].

[Pr. PC19.6_Output open phase - Judgment speed selection]

Initial value	Setting range	Ver.
0h	Refer to the text	A0

0: Servo motor speed

1: Speed command

When "0" (servo motor speed) is set, the value of the servo motor speed is used for the speed judgment of the output open-phase detection.

When "1" (speed command) is set, the speed command value is used for the speed judgment of the output open-phase detection.

When "2" (disabled (PID control)) is set in [Pr. PB25.0 Model adaptive control selection] in the torque mode or cyclic synchronous pressure mode, setting this servo parameter to "1" (speed command) does not trigger [AL. 139.2 Output open-phase error]. Set this parameter to "0" (servo motor speed).

[Pr. PC20_Function selection C-7 (*COP7)]

Initial value	Setting range	Setting method	Ver.
00000000h	Refer to the relevant detail No.	Common	Refer to the relevant detail No.

[Pr. PC20.2_Undervoltage alarm selection]

Initial value	Setting range	Ver.
0h	Refer to the text	A0

Select the alarm or warning that occurs when the bus voltage drops to the undervoltage alarm trigger level.

0: [AL. 010 Undervoltage] occurs regardless of servo motor speed

1: [AL. 0E9 Main circuit off warning] occurs when the servo motor speed is 50 r/min (50 mm/s) or less, and [AL. 010] occurs when over 50 r/min (50 mm/s).

[Pr. PC20.4_Input open-phase detection selection]

Initial value	Setting range	Ver.
0h	Refer to the text	A0

Enable or disable the detection of input open-phase detection function.

Setting this servo parameter to "1" or "2" on the MR-J5D_-_G_ triggers [AL. 037 Parameter error].

0: Automatic

1: Warning enabled

2: Alarm enabled

3: Disabled

When "0" (automatic) is set, the input open-phase detection function is enabled or disabled depending on the capacity or power supply input of the servo amplifier. Details are as follows.

Servo amplifier	Servo amplifier main circuit input voltage	Servo amplifier capacity	Input open-phase detection function
MR-J5_G(-RJ_)	3-phase AC	2 kW or less	Disabled
	1-phase AC Main circuit DC	2 kW or less	Disabled
	3-phase AC	3.5 kW or more	Warning occurrence
	Main circuit DC	3.5 kW or more	Disabled
MR-J5W_-_G_	3-phase AC	0.75 kW or less	Disabled
	1-phase AC Main circuit DC	0.75 kW or less	Disabled
	3-phase AC	1 kW or more	Warning occurrence
	Main circuit DC	1 kW or more	Disabled
MR-J5_G4_	3-phase AC	7 kW or less	Warning occurrence
MR-J5D_-_G_	—	—	Disabled

[Pr. PC20.6_Input open-phase status output selection]

Initial value	Setting range	Ver.
0h	Refer to the text	C4

Select the conditions to turn on bit 10 (S_PNL) of [Status DO 5 (Obj. 2D15h)].

When turning on the bit in an input open-phase state due to incorrect wiring or disconnection, set this servo parameter to "0" or "2".

When turning on the bit in an input open-phase state due to turning off of the main circuit power supply, set this servo parameter to "1" or "3".

- 0: Turn on during servo-on and when one phase is open
- 1: Turn on during servo-on and when one, two, or all phases are open
- 2: Turn on when one phase is open
- 3: Turn on when one, two, or all phases are open

While [Pr. PC20.4 Input open-phase detection selection] is set to "3" (disabled), bit 10 (S_PNL) of [Status DO 5] does not turn on when one phase is open. To turn on bit 10 (S_PNL) of [Status DO 5] when one phase is open, set [Pr. PC20.4] to "1" (warning enabled) or "2" (alarm enabled).

For the MR-J5D_-_G_, bit 10 (S_PNL) of [Status DO 5] is always off.

While the detection function is enabled in [Pr. PC20.4], bit 10 (S_PNL) of [Status DO 5] is always on if being used with 1-phase AC input. When using the bit with 1-phase AC input, set [Pr. PC20.4] to "3" (disabled).

[Pr. PC21_Alarm history clear (*BPS)]

Initial value	Setting range	Setting method	Ver.
00000000h	Refer to the relevant detail No.	Each axis	Refer to the relevant detail No.

[Pr. PC21.0_Alarm clear history selection]

Initial value	Setting range	Ver.
0h	Refer to the text	A0

- 0: Disabled
- 1: Enabled

When "1" (enabled) is selected, the alarm history will be cleared at either the next power cycle, at software reset, or at controller reset. After the alarm history is cleared, "0" (disabled) will be set to this servo parameter automatically.

[Pr. PC24_Deceleration time constant at forced stop (RSBR)]

Initial value	Setting range	Setting method	Ver.
100 [ms]	0 to 20000	Each axis	A0

Set the deceleration time constant for the forced stop deceleration function.

Set the time taken from the rated speed to 0 [r/min] (0 [mm/s]) in units of ms.

When "0" is set, the deceleration time constant is the same as when "100" is set.

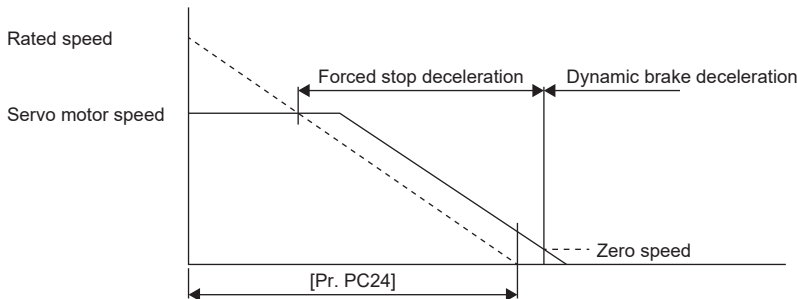

This servo parameter corresponds to [Quick stop deceleration (Obj. 6085h)]. When an object is mapped in cyclic communication, the controller overwrites the value written with engineering software. Thus, do not write a value with engineering software.

This servo parameter is enabled when [Pr. PT01.1 Speed/acceleration/deceleration unit selection] is set to "0". This servo parameter and [Pr. PV09 Deceleration at forced stop] are mutually exclusive.

- If the servo motor torque or thrust is saturated at the maximum value during forced stop deceleration because the set time is too short, the time to stop the servo motor will be longer than the set time constant.
- [AL. 050 Overload 1] or [AL. 051 Overload 2] may occur during forced stop deceleration, depending on the set value.
- After an occurrence of an alarm to execute forced stop deceleration, if another alarm that does not execute forced stop deceleration occurs, or if the control circuit power supply is shut off, dynamic braking will start regardless of the deceleration time constant setting.
- Set a longer time than deceleration time at quick stop of the controller. If the setting time is too short, [AL. 052 Excessive error] may occur.
- During forced stop deceleration, changes in the setting value are not reflected. If the setting value is changed during forced stop deceleration, the change will be reflected after the deceleration is completed.

[Pr. PC26_Function selection C-8 (**COP8)]

Initial value	Setting range	Setting method	Ver.
00000050h	Refer to the relevant detail No.	Each axis	Refer to the relevant detail No.

[Pr. PC26.3_Load-side encoder cable communication method selection]

Initial value	Setting range	Ver.
0h	Refer to the text	A0

0: Two-wire type

1: Four-wire type

When using a load-side encoder that is A/B/Z-phase differential output type, set "0". Setting "1" triggers [AL. 037 Parameter error].

If the value is set incorrectly, [AL. 070 Load-side encoder initial communication error 1] or [AL. 071 Load-side encoder normal communication error 1] occurs.

Setting "1" on servo amplifiers other than the MR-J5-_G_-RJ, MR-J5-_G_-HS_, and MR-J5D1-_G_ triggers [AL. 037].

This servo parameter is not available for the MR-J5-_G_-LL servo amplifier.

[Pr. PC27_Function selection C-9 (**COP9)]

Initial value	Setting range	Setting method	Ver.
00000000h	Refer to the relevant detail No.	Each axis	Refer to the relevant detail No.

[Pr. PC27.0_Encoder pulse count polarity selection]

Initial value	Setting range	Ver.
0h	Refer to the text	A0

In the linear servo motor control mode, the polarity of the motor-side encoder changes.

If the scale measurement function is enabled in the linear servo motor control mode, the polarity of the servo motor-side encoder changes.

0: Encoder pulse increasing direction in the servo motor CCW or positive direction

1: Encoder pulse decreasing direction in the servo motor CCW or positive direction

[Pr. PC27.2_ABZ phase input interface encoder ABZ phase connection assessment function selection]

Initial value	Setting range	Ver.
0h	Refer to the text	A0

Select the non-signal detection status for the pulse train signal from the A/B/Z-phase input interface encoder used as a linear encoder or load-side encoder.

This function is enabled when an A/B/Z-phase input interface encoder is used.

Setting value	Detection of disconnection	Alarm status		
	Z-phase-side non-signal	Rotary type (scale measurement function enabled)	Fully closed loop control mode	Linear servo motor control mode
0	Enabled	[AL. 071.6 Load-side encoder normal communication - Transmission data error 2] (Z-phase)	[AL. 071.6] (Z-phase)	[AL. 020.6 Encoder normal communication - Transmission data error 2] (Z-phase)
1	Disabled	—	—	—

[Pr. PC27.5_Scale measurement encoder selection]

Initial value	Setting range	Ver.
0h	Refer to the text	A5

Select a scale measurement encoder when using an A/B/Z-phase differential output type encoder.

This setting is enabled only when an A/B/Z-phase differential output type encoder is connected to CN2L or CN2AL.

If this servo parameter is set to "1" in the standard control mode or direct drive motor control mode while connected to an A/B/Z-phase differential output linear encoder, [AL. 01A Servo motor combination error] occurs.

If this servo parameter is set to "1" in the standard control mode or linear servo motor control mode while connected to an A/B/Z-phase differential output rotary encoder, [AL. 01A Servo motor combination error] occurs.

0: Use the A/B/Z-phase differential output type encoder as a scale measurement encoder

1: Use a serial encoder as a scale measurement encoder

This servo parameter is not available for the MR-J5-_G_-LL servo amplifier.

[Pr. PC27.6_Multipoint Z-phase linear encoder monitor selection]

Initial value	Setting range	Ver.
0h	Refer to the text	D8

When multiple reference marks exist during the full stroke of the linear encoder, set "1".

0:Automatic setting

1:Enabled

If an encoder other than the incremental linear encoder or A/B/Z-phase differential output linear encoder is connected, the setting value of this servo parameter is disabled.

[Pr. PC29_Function selection C-B (*COPB)]

Initial value	Setting range	Setting method	Ver.
00101000h	Refer to the relevant detail No.	Each axis	Refer to the relevant detail No.

[Pr. PC29.0_[AL. 0E2.2 Servo motor temperature warning 2] selection]

Initial value	Setting range	Ver.
0h	Refer to the text	A0

Select whether to enable or disable [AL. 0E2.2 Servo motor temperature warning 2] when a servo motor with a batteryless absolute position encoder is used.

0: Enabled

1: Disabled

[Pr. PC29.3_Torque POL reflection selection]

Initial value	Setting range	Ver.
1h	Refer to the text	A0

When this servo parameter setting is enabled, setting of [Pr. PA14 Travel direction selection] changes the polarities in the following items: torque command ([Target torque (Obj. 6071h)] and [Torque demand value (Obj. 6074h)]), torque limit value ([Positive torque limit value (Obj. 60E0h)] and [Negative torque limit value (Obj. 60E1h)]), and torque feedback ([Torque actual value (Obj. 6077h)]).

0: Enabled

1: Disabled

Setting value		Selection of servo motor rotation direction/linear servo motor travel direction	
[Pr. PC29.3]	[Pr. PA14]	Torque handled by the controller: positive	Torque handled by the controller: negative
0: Enabled	0	CCW or positive direction (Forward rotation in power running mode, reverse rotation in regenerative mode)	CW or negative direction (Reverse rotation in power running mode, forward rotation in regenerative mode)
	1	CW or negative direction (Reverse rotation in power running mode, forward rotation in regenerative mode)	CCW or positive direction (Forward rotation in power running mode, reverse rotation in regenerative mode)
1: Disabled	0	CCW or positive direction (Forward rotation in power running mode, reverse rotation in regenerative mode)	CW or negative direction (Reverse rotation in power running mode, forward rotation in regenerative mode)
	1	CCW or positive direction (Forward rotation in power running mode, reverse rotation in regenerative mode)	CW or negative direction (Reverse rotation in power running mode, forward rotation in regenerative mode)

[Pr. PC29.5_[AL. 0E3 Absolute position counter warning] selection]

Initial value	Setting range	Ver.
1h	Refer to the text	A0
Setting digit (BIN)	Functions	
___x	<p>[AL. 0E3 Absolute position counter warning] selection</p> <p>0: Disabled</p> <p>1: Enabled</p> <p>While this servo parameter is set to "0" (disabled), [AL. 0E3] does not occur even when the rotation amount exceeds the maximum value of the multi-revolution counter or falls below the minimum value.</p> <p>Set this servo parameter to "0" (disabled) when configuring the absolute position detection system in cyclic synchronous mode with a motion module manufactured by Mitsubishi Electric.</p> <p>While the infinite feed function ("2" (degree unit) in [Pr. PT01.2 Unit for position data]) is used, [AL. 0E3.1 Multi-revolution counter travel distance excess warning] does not occur even when this servo parameter is set to "1" (enabled).</p>	
__x_	For manufacturer setting	
_x__	For manufacturer setting	
x___	For manufacturer setting	

[Pr. PC31_Vertical axis freefall prevention compensation amount (RSUP1)]

Initial value	Setting range	Setting method	Ver.
0 [0.0001 rev], [0.01 mm]	-25000 to 25000	Each axis	A0

Set the compensation amount of the vertical axis freefall prevention function.

Set the compensation amount in either the servo motor rotation amount unit or linear servo motor travel distance unit.

When a positive value is set, the compensation is performed to the command address increasing direction. When a negative value is set, compensation is performed to the command address decreasing direction.

The vertical axis freefall prevention function is performed when all of the following conditions are met.

- The control mode is set for the position mode or positioning mode.
- The setting value of this servo parameter is other than "0".
- The forced stop deceleration function is enabled.
- An alarm has occurred or EM2 has turned off when the servo motor rotates at the zero speed or less. Or, the Quick stop command was issued.
- MBR (Electromagnetic brake interlock) was enabled in [Pr. PD07 Output device selection 1] to [Pr. PD09 Output device selection 3] while the base circuit shut-off delay time was set in [Pr. PC02 Electromagnetic brake sequence output].

[Pr. PC38_Excessive error warning trigger level (ERW)]

Initial value	Setting range	Setting method	Ver.
0 [rev], [mm]	0 to 1000	Each axis	A0

Set the excessive error warning trigger level.

The unit can be changed with [Pr. PC06.3 Excessive error alarm trigger level/excessive error warning trigger level - Unit selection].

If using a rotary servo motor or direct drive motor, set the level in units of rev. If 200 rev or higher is set, the value will be clamped to 200 rev.

If using a linear servo motor, set the level in units of mm.

When "0" is set, [AL. 09B Excessive error warning] does not occur.

If an error reaches the set value, [AL. 09B] occurs. If the error later becomes less than the setting value, the warning will be automatically canceled. The minimum pulse width of the warning signal output is 100 [ms].

Set as follows: [Pr. PC38 Excessive error warning trigger level] < [Pr. PC01 Excessive error alarm trigger level]. When set as [Pr. PC38] ≥ [Pr. PC01], [AL. 052 Excessive error] occurs before the warning.

[Pr. PC41_Function selection C-J (*COPJ)]

Initial value	Setting range	Setting method	Ver.
00000000h	Refer to the relevant detail No.	Each axis	Refer to the relevant detail No.

[Pr. PC41.0_[AL. 090.1 Homing incomplete] detection selection]

Initial value	Setting range	Ver.
0h	Refer to the text	A5

Enable or disable [AL. 090.1 Homing incomplete].

This function is enabled in the cyclic synchronous position mode.

When setting this servo parameter to "1" (disabled), set [Pr. PC29.5 [AL. 0E3 Absolute position counter warning] selection] to "0" (disabled).

0: Enabled

1: Disabled

[Pr. PC41.3_Electromagnetic brake sequence output function selection]

Initial value	Setting range	Ver.
0h	Refer to the text	C0

When shifting the PDS state from the Operation enabled state to servo-off, select a state after transition which enables [Pr. PC02 Electromagnetic brake sequence output]. The state changes to the one selected with this servo parameter after the time set in [Pr. PC02] has passed.

0: Switched on

1: Switched on/Ready to switch on/Switch on disabled

When [Pr. PC46.2 Protection coordination multiple connections selection] is set to "1" (connect multiple MR-J5D_-_G_ to the converter unit), setting this servo parameter to "1" triggers [AL. 037 Parameter error].

[Pr. PC42_Function selection C-10 (COP10)]

Initial value	Setting range	Setting method	Ver.
00000000h	Refer to the relevant detail No.	Each axis	Refer to the relevant detail No.

[Pr. PC42.0_Forward/Reverse rotation torque limit 2 selection]

When the command interface of the servo amplifier is CC-Link IE TSN, this servo parameter is not available.

Initial value	Setting range	Ver.
0h	Refer to the text	A5

Enable or disable the torque limit value switching which is performed by CPTL (bit 11 of [Controlword (Obj. 6040h)]) and by CNTL (bit 12 of [Controlword]).

0: Disabled

1: Enabled

For the combinations of servo parameters and objects that are switched by CPTL/CNTL, refer to the following table.

[Pr. PC42.0]/ [Positive/Negative torque limit 2 select (Obj. 2D6Dh: 01h)]	Forward rotation torque limit value		Reverse rotation torque limit value	
	CPTL: 0	CPTL: 1	CNTL: 0	CNTL: 1
0h/ 0000h	[Pr. PA11]/ [Positive torque limit value (Obj. 60E0h)]	[Pr. PA11]/ [Positive torque limit value (Obj. 60E0h)]	[Pr. PA12]/ [Negative torque limit value (Obj. 60E1h)]	[Pr. PA12]/ [Negative torque limit value (Obj. 60E1h)]
1h/ 0001h	[Pr. PA11]/ [Positive torque limit value (Obj. 60E0h)]	[Pr. PC43]/ [Positive torque limit value2 (Obj. 2D6Dh: 02h)]	[Pr. PA12]/ [Negative torque limit value (Obj. 60E1h)]	[Pr. PC44]/ [Negative torque limit value2 (Obj. 2D6Dh: 03h)]

This servo parameter corresponds to [Positive/Negative torque limit 2 select (Obj. 2D6Dh: 01h)].

[Pr. PC43_Foward rotation torque limit 2 (TLP2)]

When the command interface of the servo amplifier is CC-Link IE TSN, this servo parameter is not available.

Initial value	Setting range	Setting method	Ver.
1000.0 [%]	0.0 to 1000.0	Each axis	A5

The torque or thrust generated by the servo motor can be limited.

Set this servo parameter in relation to the rated torque or continuous thrust (= 100.0 %). Set the servo parameter when limiting the torque of the servo motor for CCW power running or CW regeneration, or when limiting the thrust of the linear servo motor for positive direction power running or negative direction regeneration. If this servo parameter is set to "0.0", the servo motor does not generate torque or thrust.

The polarity of the torque limit can be changed with the setting values of [Pr. PA14 Travel direction selection] and [Pr. PC29.3 Torque POL reflection selection].

This servo parameter corresponds to [Positive torque limit value 2 (Obj. 2D6Dh: 02h)].

Depending on the settings in [Pr. PC29] and [Pr. PA14], the corresponding object changes to [Negative torque limit value 2 (Obj. 2D6Dh: 03h)].

If a value larger than the maximum torque or maximum thrust of the servo motor is set, the value will be limited to the maximum torque or maximum thrust of the servo motor.

[Pr. PC44_Reverse rotation torque limit 2 (TLN2)]

When the command interface of the servo amplifier is CC-Link IE TSN, this servo parameter is not available.

Initial value	Setting range	Setting method	Ver.
1000.0 [%]	0.0 to 1000.0	Each axis	A5

The torque or thrust generated by the servo motor can be limited.

Set this servo parameter in relation to the rated torque or continuous thrust (= 100.0 %). Set the servo parameter when limiting the torque of the servo motor for CW power running or CCW regeneration, or when limiting the thrust of the linear servo motor for negative direction power running or positive direction regeneration. If this servo parameter is set to "0.0", the servo motor does not generate torque or thrust.

The polarity of the torque limit can be changed with the setting values of [Pr. PA14 Travel direction selection] and [Pr. PC29.3 Torque POL reflection selection]. This servo parameter corresponds to [Negative torque limit value 2 (Obj. 2D6Dh: 03h)].

Depending on the settings in [Pr. PC29] and [Pr. PA14], the corresponding object changes to [Positive torque limit value 2 (Obj. 2D6Dh: 02h)].

If a value larger than the maximum torque or maximum thrust of the servo motor is set, the value will be limited to the maximum torque or maximum thrust of the servo motor.

[Pr. PC46_Drive unit function selection 2 (*DUOP2)]

Initial value	Setting range	Setting method	Ver.
00000000h	Refer to the relevant detail No.	Common	Refer to the relevant detail No.

[Pr. PC46.1_Converter stop mode selection]

Initial value	Setting range	Ver.
0h	Refer to the text	C0

Select the converter stop mode.

0: Converter main circuit MC off in occurrence of the converter stop alarm

1: Converter main circuit MC off in occurrence of an alarm

This servo parameter can be used only with the MR-J5D_-_G_. The setting value of this servo parameter is disabled for servo amplifiers other than the MR-J5D_-_G_.

When this servo parameter is set to "1", all alarms are applicable to converter main circuit stop. Alternatively, the motor stop method of all the alarms changes to DB (Dynamic brake stop). For the alarms applicable to converter main circuit stop and motor stop methods, refer to "List of alarm No./warning No." in the following manual.

MR-J5 User's Manual (Troubleshooting)

[Pr. PC46.2_Protection coordination multiple connection selection]

Initial value	Setting range	Ver.
0h	Refer to the text	C0

When connecting multiple MR-J5D_-_G_ to one converter unit using a protection coordination cable, set this servo parameter to "1".

0: Connect one MR-J5D_-_G_ to one converter unit.

1: Connect multiple MR-J5D_-_G_ to one converter unit.

This servo parameter can be used only with the MR-J5D_-_G_. The setting value of this servo parameter is disabled for servo amplifiers other than the MR-J5D_-_G_.

When this servo parameter is set to "1", the motor stop method of the alarm changes to DB (Dynamic brake stop) if all axes are specified for the stop system. For the motor stop method, refer to "List of alarm No./warning No." in the following manual.

MR-J5 User's Manual (Troubleshooting)

[Pr. PC46.3_Protection coordination end terminal setting]

Initial value	Setting range	Ver.
0h	Refer to the text	C0

When connecting multiple MR-J5D_-_G_ to one converter unit using a protection coordination cable, set this servo parameter to "1" on the end terminal drive unit.

0: Terminal settings disabled

1: Terminal settings enabled (end terminal)

This servo parameter can be used only with the MR-J5D_-_G_. The setting value of this servo parameter is disabled for servo amplifiers other than the MR-J5D_-_G_.

This servo parameter is enabled only when [Pr. PC46.2 Protection coordination multiple connections selection] is set to "1" (connect multiple MR-J5D_-_G_ to the converter unit). The setting value of this servo parameter is disabled when [Pr. PC46.2] is set to "0" (connect one MR-J5D_-_G_ to one converter unit).

If the setting value of this servo parameter does not match the connection status of the protection coordination cable, [AL. 11B Protection coordination connection error] occurs.

[Pr. PC65_Zero speed 2 level (ZSP2L)]

Initial value	Setting range	Setting method	Ver.
50.00 [r/min], [mm/s]	0.00 to 655.35	Each axis	A5

Set the level of speed at which zero speed 2 turns on.

If the state where the absolute value of the servo motor speed exceeds the setting value of this servo parameter continues for the time set in [Pr. PC66 Zero speed 2 filtering time] or longer, bit 12 (Speed) of [Statusword (Obj. 6041h)] turns off.

This function is enabled in the profile velocity mode.

This servo parameter corresponds to [Velocity threshold (Obj. 606Fh)]. When an object is mapped in cyclic communication, the controller overwrites the value written with engineering software. Thus, do not write a value with engineering software.

This servo parameter is enabled when [Pr. PT01.1 Speed/acceleration/deceleration unit selection] is set to "0". This servo parameter and [Pr. PV20 Zero speed 2 level extension setting] are mutually exclusive.

[Pr. PC66_Zero speed 2 filtering time (ZSP2F)]

Initial value	Setting range	Setting method	Ver.
10 [ms]	0 to 65535	Each axis	A5

This servo parameter sets the zero speed 2 filtering time.

If the state where the absolute value of the servo motor speed exceeds [Pr. PC65 Zero speed 2 level] continues for the setting value of this servo parameter or longer, bit 12 (Speed) of [Statusword (Obj. 6041h)] turns off.

This function is enabled in the profile velocity mode.

This servo parameter corresponds to [Velocity threshold time (Obj. 6070h)]. When an object is mapped in cyclic communication, the controller overwrites the value written with engineering software. Thus, do not write a value with engineering software.

[Pr. PC67_Following error output level (FEW)]

Initial value	Setting range	Setting method	Ver.
00C0000h [Command unit]	00000000h to FFFFFFFFh	Each axis	A0

Set the output level of the following error output.

When the state of "droop pulses \geq the parameter setting value" continues for the time set in [Pr. PC69 Following error output filtering time], bit 13 (Following error) of [Statusword (Obj. 6041h)] turns on.

If "FFFFFFFh" is set, the following error output will be disabled.

Set the value in hexadecimal.

This function is enabled in the cyclic synchronous position mode, profile position mode, point table mode, and JOG operation mode.

This servo parameter corresponds to [Following error window (Obj. 6065h)]. When an object is mapped in cyclic communication, the controller overwrites the value written with engineering software. Thus, do not write a value with engineering software.

The command unit can be changed to 0.001 mm, 0.0001 inch, 0.001 degree or pulses with [Pr. PT01.2 Unit for position data].

☞ Page 166 [Pr. PT01.2_Unit for position data]

[Pr. PC69_ Following error output filtering time (FEWF)]

Initial value		Setting range	Setting method	Ver.	
J5G	J5G-N1			J5G	J5G-N1
10 [ms]	0 [ms]	0 to 65535	Each axis	A0	A5

Set the time until the following error output turns on.

When the state in which droop pulses \geq [Pr. PC67 Following error output level] continues for the time set in the servo parameter setting value, bit 13 (Following error) of [Statusword (Obj. 6041h)] turns on.

This function is enabled in the cyclic synchronous position mode, profile position mode, point table mode, and JOG operation mode.

This servo parameter corresponds to [Following error time out (Obj. 6066h)]. When an object is mapped in cyclic communication, the controller overwrites the value written with engineering software. Thus, do not write a value with engineering software.

When the setting value of [Pr. PC67] is "FFFFFFFFh", the following error output is disabled.

[Pr. PC70_ In-position 2 - Output range (INP2R)]

Initial value	Setting range	Setting method	Ver.
400 [Command unit]	0 to 4294967295	Each axis	A5

Set the position range where the in-position 2 output turns on.

If the state where the error between the command position and the actual position is within the setting value of this servo parameter continues for the time set in [Pr. PC71 In-position 2 - Output filtering time] or longer, bit 10 (Target reached) of [Statusword (Obj. 6041h)] turns on.

However, if "4294967295" is set, bit 10 (Target reached) of [Statusword (Obj. 6041h)] is always turned on.

This function is enabled in the profile position mode, point table mode, and JOG operation mode.

This servo parameter corresponds to [Position window (Obj. 6067h)]. When an object is mapped in cyclic communication, the controller overwrites the value written with engineering software. Thus, do not write a value with engineering software.

The command unit can be changed to 0.001 mm, 0.0001 inch, 0.001 degree or pulses with [Pr. PT01.2 Unit for position data].

 Page 166 [Pr. PT01.2_Unit for position data]

[Pr. PC71_ In-position 2 - Output filtering time (INP2F)]

Initial value		Setting range	Setting method	Ver.
J5G	J5G-N1			
10 [ms]	0 [ms]	0 to 65535	Each axis	A5

This servo parameter sets the time until the in-position 2 output turns on.

If the state where the error between the command position and the actual position is within [Pr. PC70 In-position 2 - Output range] continues for the setting value of this servo parameter or longer, bit 10 (Target reached) of [Statusword (Obj. 6041h)] turns on. When [Pr. PC70] is set to "4294967295", bit 10 (Target reached) of [Statusword (Obj. 6041h)] is always turned on.

This function is enabled in the profile position mode, point table mode, and JOG operation mode.

This servo parameter corresponds to [Position window time (Obj. 6068h)]. When an object is mapped in cyclic communication, the controller overwrites the value written with engineering software. Thus, do not write a value with engineering software.

[Pr. PC72_Speed reached 2 - Output range (SA2R)]

Initial value	Setting range	Setting method	Ver.
20.00 [r/min], [mm/s]	0.00 to 655.35	Each axis	A5

This servo parameter sets the range of speed at which speed reached 2 output turns on.

If the state where the error between the command speed and the servo motor speed is within the setting value of this servo parameter continues for the time set in [Pr. PC73 Speed reached 2 - Output filtering time] or longer, bit 10 (Target velocity reached) of [Statusword (Obj. 6041h)] turns on.

This function is enabled in the profile velocity mode.

This servo parameter corresponds to [Velocity window (Obj. 606Dh)]. When an object is mapped in cyclic communication, the controller overwrites the value written with engineering software. Thus, do not write a value with engineering software.

This servo parameter is enabled when [Pr. PT01.1 Speed/acceleration/deceleration unit selection] is set to "0". This servo parameter and [Pr. PV19 Speed reached 2 - Output range - Extension setting] are mutually exclusive.

[Pr. PC73_Speed reached 2 - Output filtering time (SA2F)]

Initial value		Setting range	Setting method	Ver.
J5G	J5G-N1			
10 [ms]	0 [ms]	0 to 65535	Each axis	A5

This servo parameter sets the time until the speed reached 2 output turns on.

If the state where the error between the speed command and the servo motor speed is within [Pr. PC72 Speed reached 2 - Output filtering time] continues for the setting value of this servo parameter or longer, bit 10 (Target velocity reached) of [Statusword (Obj. 6041h)] turns on.

This function is enabled in the profile velocity mode.

This servo parameter corresponds to [Velocity window time (Obj. 606Eh)]. When an object is mapped in cyclic communication, the controller overwrites the value written with engineering software. Thus, do not write a value with engineering software.

[Pr. PC76_Function selection C-E (*COPE)]

Initial value	Setting range	Setting method	Ver.
00000001h	Refer to the relevant detail No.	Each axis	Refer to the relevant detail No.

[Pr. PC76.1_ZSP disabled selection at control switching]

Initial value	Setting range	Ver.
0h	Refer to the text	A0

Select whether to switch the control mode from or to the position mode within the ZSP range.

0: Enabled (control switching is performed within the range of ZSP)

1: Disabled (control switching is performed regardless of the range of ZSP)

If set to "Disabled", control switching may cause a shock.

[Pr. PC76.2_Internal command speed POL reflection selection]

Initial value	Setting range	Ver.
0h	Refer to the text	A0

When this function is enabled, the polarity in [Velocity demand value (Obj. 606Bh)] can be changed with the setting value of [Pr. PA14 Travel direction selection].

0: Automatic setting (1: POL setting enabled)

1: POL setting enabled

2: POL setting disabled

[Pr. PC76.3_Limit switch status read selection]

Initial value	Setting range	Ver.
0h	Refer to the text	B2

The outputs of LSP (Forward rotation stroke end) or LSN (Reverse rotation stroke end) read by [Digital inputs (Obj. 60FDh)] can be reversed.

Refer to the following table for information regarding this servo parameter and outputs.

Setting value	LSP/LSN	[Digital inputs (Obj. 60FDh)]
0	OFF	0
	ON	1
1	OFF	1
	ON	0

[Pr. PC78_Function selection C-F (*COPF)]

Initial value		Setting range	Setting method	Ver.
J5G	J5G-N1			
00000000h	00000010h	Refer to the relevant detail No.	Each axis	Refer to the relevant detail No.

[Pr. PC78.1_Maximum torque limit 1 selection]

Initial value		Setting range	Ver.
J5G	J5G-N1		
0h	1h	Refer to the text	A5

Select whether to enable or disable the maximum torque limit 1.

0: Disabled

1: Enabled

[Pr. PC79_Function selection C-G (*COPG)]

Initial value	Setting range	Setting method	Ver.
00000000h	Refer to the relevant detail No.	Each axis	Refer to the relevant detail No.

For DI pin numbers corresponding to setting digits, refer to the following table.

If this servo parameter is set incorrectly, [AL. 037 Parameter error] may occur.

- MR-J5- _G_/MR-J5W- _G_

Servo parameter number	Setting digit (BIN)	Name	DI pin						
			MR-J5- _G_	MR-J5- _G_-RJ_	MR-J5- _G_-HS_	MR-J5- _G_-LL	MR-J5W- _G_		
							A-axis	B-axis	C-axis
[Pr. PC79.0]	___x	For manufacturer setting	—	—	—	—	—	—	—
	__x_	DI1 status read selection	CN3-2	CN3-2	CN3-5A	CN3-2	CN3-7	CN3-20	CN3-1
	_x__	DI2 status read selection	CN3-12	CN3-12	CN3-5B	CN3-12	CN3-8	CN3-21	CN3-2
	x___	DI3 status read selection	CN3-19	CN3-19	CN3-6B	CN3-19	CN3-9	CN3-22	CN3-15
[Pr. PC79.1]	___x	DI4 status read selection	CN3-10 ^{*1}	CN3-10	CN3-4A	—	—	—	—
	__x_	DI5 status read selection	CN3-1 ^{*1}	CN3-1	CN3-4B	CN3-1	—	—	—
	_x__	EM2/EM1 status read selection	CN3-20	CN3-20	CN3-3B	CN3-20	CN3-10	CN3-10	CN3-10
	x___	For manufacturer setting	—	—	—	—	—	—	—

*1 Available on servo amplifiers with firmware version C0 or later and manufactured in June 2021 or later.

- MR-J5D- _G_

Servo parameter number	Setting digit (BIN)	Name	DI pin			
			MR-J5D1- _G_	MR-J5D2- _G_/MR-J5D3- _G_		
				A-axis	B-axis	C-axis
[Pr. PC79.0]	___x	For manufacturer setting	—	—	—	—
	__x_	DI1 status read selection	CN3-12	CN3-12	CN3-26	CN3-10
	_x__	DI2 status read selection	CN3-28	CN3-28	CN3-25	CN3-9
	x___	DI3 status read selection	CN3-29	CN3-29	CN3-27	CN3-11
[Pr. PC79.1]	___x	DI4 status read selection	CN3-11	—	—	—
	__x_	DI5 status read selection	CN3-27	—	—	—
	_x__	EM2/EM1 status read selection	CN3-13	CN3-13	CN3-13	CN3-13
	x___	For manufacturer setting	—	—	—	—

[Pr. PC79.0_DI status read selection]

Initial value	Setting range	Ver.
00h	Refer to the text	A5

Select whether to return the on/off state of the input device or the on/off state of the pin when reading [Digital inputs (Obj. 60FDh)].

Setting digit (BIN)	Functions
___x	For manufacturer setting
__x_	DI1 status read selection Select the DI1 (bit 17) status read operation. 0: Returns the on/off state of the input device. 1: Returns the on/off state of DI1 pin.
_x__	DI2 status read selection Select the DI2 (bit 18) status read operation. 0: Returns the on/off state of the input device. 1: Returns the on/off state of DI2 pin.
x___	DI3 status read selection Select the DI3 (bit 19) status read operation. 0: Returns the on/off state of the input device. 1: Returns the on/off state of DI3 pin.

[Pr. PC79.1_DI status read selection]

Initial value	Setting range	Ver.
00h	Refer to the text	A5

Select whether to return the on/off state of the input device or the on/off state of the pin when reading [Digital inputs (Obj. 60FDh)].

Setting digit (BIN)	Functions
___x	DI4 status read selection Select the DI4 (bit 20) status read operation. 0: Returns the on/off state of the input device. 1: Returns the on/off state of DI4 pin.
__x_	DI5 status read selection Select the DI5 (bit 21) status read operation. 0: Returns the on/off state of the input device. 1: Returns the on/off state of DI5 pin.
_x__	EM2/EM1 status read selection Select the EM2/EM1 (bit 22) status read operation. 0: Returns the on/off state of the input device. 1: Returns the on/off state of EM2/EM1 pin.
x___	For manufacturer setting

[Pr. PC81_For manufacturer setting]

This servo parameter is for manufacturer setting.

[Pr. PC96_ Output open-phase detection time (*OPDT)]

Initial value	Setting range	Setting method	Ver.
0 [0.1 s]	0 to 100	Each axis	E8

Set the output open-phase detection time.

This servo parameter is enabled when "2" (enabled ([Pr. PC96 Output open-phase detection time] enabled)) is selected in [Pr. PC19.4 Output open-phase detection selection]. When a value other than "2" is selected, the setting value of this servo parameter is disabled.

Changing the detection time changes the detection start speed. For the relationship among [Pr. PA01.1 Operation mode selection], [Pr. PC96], and the detection start speed, refer to the following table.

Setting value [0.1 s]	Output open-phase detection time [s]	Detection start speed [r/min] *1		
		[Pr. PA01.1] = "0" (standard control mode)	[Pr. PA01.1] = "4" (linear servo motor control mode)	[Pr. PA01.1] = "6" (direct drive motor control mode)
0	Automatic (3.0 s)	50	50	25
1	0.1	2600	2600	1300
2	0.2	1250	1250	625
3	0.3	850	850	425
4	0.4	600	600	300
5	0.5	500	500	250
10	1.0	250	250	125
20	2.0	100	100	50
25	2.5	100	100	50
26	2.6	50	50	25
30	3.0			
40	4.0			
50	5.0			
60	6.0			
70	7.0			
80	8.0			
90	9.0			
100	10.0			

*1 Setting a value that exceeds the maximum speed of the connected servo motor in the detection start speed triggers [AL. 037 Parameter error].

1.5 I/O setting servo parameters group ([Pr. PD_ _])

[Pr. PD01_Input signal automatic ON selection 1 (*DIA1)]

Initial value	Setting range	Setting method	Ver.
00000000h	Refer to the relevant detail No.	Each axis	Refer to the relevant detail No.

[Pr. PD01.0_For manufacturer setting]

This servo parameter is for manufacturer setting.

[Pr. PD01.1_For manufacturer setting]

This servo parameter is for manufacturer setting.

[Pr. PD01.2_Input signal automatic ON selection]

Initial value	Setting range	Ver.
0h	Refer to the text	A0

Select input devices that turn on automatically.

Setting digit (BIN)	Functions
___x	For manufacturer setting
__x_	For manufacturer setting
_x__	Forward rotation stroke end (LSP) 0: Use for an external input signal 1: Automatic on
x___	Reverse rotation stroke end (LSN) 0: Use for an external input signal 1: Automatic on

[Pr. PD01.3_For manufacturer setting]

This servo parameter is for manufacturer setting.

[Pr. PD01.4_For manufacturer setting]

This servo parameter is for manufacturer setting.

[Pr. PD01.5_For manufacturer setting]

This servo parameter is for manufacturer setting.

[Pr. PD01.6_For manufacturer setting]

This servo parameter is for manufacturer setting.

[Pr. PD01.7_For manufacturer setting]

This servo parameter is for manufacturer setting.

[Pr. PD03_Input device selection 1 (*DI1)]

Initial value	Setting range	Setting method	Ver.
0000000Ah	Refer to the relevant detail No.	Each axis	Refer to the relevant detail No.

Select the device to be assigned to the input signal of the CN3 connector. The pin numbers of the connector to be assigned are as follows.

Model	Shaft	Connector pin No.	Initially assigned device
MR-J5-_G_(-RJ_) MR-J5-_G_-LL	—	CN3-2	LSP
MR-J5-_G_-HS_	—	CN3-5A	LSP
MR-J5W2-_G_	A-axis	CN3-7	LSP-A
	B-axis	CN3-20	LSP-B
MR-J5W3-_G_	A-axis	CN3-7	LSP-A
	B-axis	CN3-20	LSP-B
	C-axis	CN3-1	LSP-C
MR-J5D1-_G_	—	CN3-12	LSP
MR-J5D2-_G_	A-axis	CN3-12	LSP-A
	B-axis	CN3-26	LSP-B
MR-J5D3-_G_	A-axis	CN3-12	LSP-A
	B-axis	CN3-26	LSP-B
	C-axis	CN3-10	LSP-C

[Pr. PD03.0-1_Device selection]

Initial value	Setting range	Ver.
0Ah	Refer to the text	A0

Refer to the following table for setting values.

Setting value	Input signal device
00	No assigned function
04	PC
0A	LSP
0B	LSN
0D	CDP
0E	CLD *1
22	DOG
2C	TPR1 *1*2*3
2D	TPR2 *1*2*3
40	CDP2
62	No assigned function
63	TPR3 *1*2*3

*1 Available on servo amplifiers with firmware version A5 or later.

*2 For the MR-J5-_G_, the device is available on servo amplifiers with firmware version C0 or later and manufactured after June 2021. When using TPR1, 2, or 3 with the MR-J5-_G_, assigning TPR1, 2, or 3 to [Pr. PD03 Input device selection 1], [Pr. PD04 Input device selection 2], or [Pr. PD05 Input device selection 3] will cause [AL. 037 Parameter error] to occur.

*3 When using TPR1, 2, or 3 with the MR-J5-_G_-RJ_, MR-J5-_G_-HS_, MR-J5W_-_G_ and MR-J5D_-_G_, assigning TPR1, 2, or 3 to [Pr. PD03] or [Pr. PD04] will cause [AL. 037] to occur.

[Pr. PD04_Input device selection 2 (*DI2)]

Initial value	Setting range	Setting method	Ver.
0000000Bh	Refer to the relevant detail No.	Each axis	Refer to the relevant detail No.

Select the device to be assigned to the input signal of the CN3 connector. The pin numbers of the connector to be assigned are as follows.

Model	Shaft	Connector pin No.	Initially assigned device
MR-J5-G_(-RJ_) MR-J5-G_-LL	—	CN3-12	LSN
MR-J5-G_-HS_	—	CN3-5B	LSN
MR-J5W2-G_	A-axis	CN3-8	LSN-A
	B-axis	CN3-21	LSN-B
MR-J5W3-G_	A-axis	CN3-8	LSN-A
	B-axis	CN3-21	LSN-B
	C-axis	CN3-2	LSN-C
MR-J5D1-G_	—	CN3-28	LSN
MR-J5D2-G_	A-axis	CN3-28	LSN-A
	B-axis	CN3-25	LSN-B
MR-J5D3-G_	A-axis	CN3-28	LSN-A
	B-axis	CN3-25	LSN-B
	C-axis	CN3-9	LSN-C

[Pr. PD04.0-1_Device selection]

Initial value	Setting range	Ver.
0Bh	Refer to the text	A0

Refer to the following for details of setting values.

☞ Page 100 [Pr. PD03_Input device selection 1 (*DI1)]

[Pr. PD05_Input device selection 3 (*DI3)]

Initial value	Setting range	Setting method	Ver.
00000022h	Refer to the relevant detail No.	Each axis	Refer to the relevant detail No.

Select the device to be assigned to the input signal of the CN3 connector. The pin numbers of the connector to be assigned are as follows.

Model	Shaft	Connector pin No.	Initially assigned device
MR-J5-_G_(-RJ_) MR-J5-_G_-LL	—	CN3-19	DOG
MR-J5-_G_-HS_	—	CN3-6B	DOG
MR-J5W2-_G_	A-axis	CN3-9	DOG-A
	B-axis	CN3-22	DOG-B
MR-J5W3-_G_	A-axis	CN3-9	DOG-A
	B-axis	CN3-22	DOG-B
	C-axis	CN3-15	DOG-C
MR-J5D1-_G_	—	CN3-29	DOG
MR-J5D2-_G_	A-axis	CN3-29	DOG-A
	B-axis	CN3-27	DOG-B
MR-J5D3-_G_	A-axis	CN3-29	DOG-A
	B-axis	CN3-27	DOG-B
	C-axis	CN3-11	DOG-C

[Pr. PD05.0-1_Device selection]

Initial value	Setting range	Ver.
22h	Refer to the text	A0

Refer to the following for details of setting values.

☞ Page 100 [Pr. PD03_Input device selection 1 (*DI1)]

■Using touch probe function

The touch probe function can be used by setting this servo parameter to TPR1 to TPR3.

Setting this servo parameter to TPR1 to TPR3 on the MR-J5-_G_ triggers [AL. 037 Parameter error].

If duplicated input devices (TPR1 to TPR3) exist in [Pr. PD05], [Pr. PD38] and [Pr. PD39], [AL. 037 Parameter error] occurs.

Ex.

When TPR1 is duplicated, such as when [Pr. PD05.0] = "2Ch" (TPR1) and [Pr. PD38.0] = "2Ch" (TPR1)

[Pr. PD05.4_Input axis selection 3]

Initial value	Setting range	Ver.
0h	Refer to the text	A5

For a multi-axis servo amplifier, set which axis will use the input device that was assigned in [Pr. PD05.0-1 Device selection]. When this servo parameter is "0h", only the axis to which the device is assigned by [Pr. PD05.0-1] is automatically set to be enabled.

Servo parameter number	Setting digit (BIN)	Setting details
[Pr. PD05.4]	___x	A-axis selection 0: Disabled 1: Enabled
	__x_	B-axis selection 0: Disabled 1: Enabled
	_x__	C-axis selection 0: Disabled 1: Enabled

When A-axis selection is enabled, the device name is ___-A. (Example: TPR1-A)

When B-axis selection is enabled, the device name is ___-B. (Example: TPR1-B)

When C-axis selection is enabled, the device name is ___-C. (Example: TPR1-C)

When multiple axes are enabled with this servo parameter, the input device signal is enabled for multiple axes simultaneously. For example, when [Pr. PD05.4] = "5h" (A and C-axes enabled) and [Pr. PD05.0] = "2Ch" (TPR1) are set for the A-axis, TPR1-A and TPR1-C are enabled with the input signal of CN3-9 pin.

In the following cases, [AL. 037 Parameter error] occurs.

- When other than "0h" is set for a 1-axis servo amplifier
- When C-axis selection is enabled on the MR-J5W2-G_ or MR-J5D2-_G_
- When this servo parameter is set to a value other than "0h" while the input device is set to other than TPR1, TPR2, or TPR3
- When duplicated input devices exist  Page 103 Example of duplicated settings

■ Example of duplicated settings

When TPR1-B is duplicated, such as when for the A axis, [Pr. PD05.4] = "3h" (A and B axes enabled) and [Pr. PD05.0] = "2Ch" (TPR1); and for the B axis, [Pr. PD05.4] = "0h" (automatic setting: B axis enabled) and [Pr. PD05.0] = "2Ch" (TPR1)

[Pr. PD07_Output device selection 1 (*DO1)]

Initial value	Setting range	Setting method	Ver.
00000005h	Refer to the relevant detail No.	Each axis	Refer to the relevant detail No.

Select the device to be assigned to the output signal of CN3 connector. The pin numbers of the connector to be assigned are as follows.

Model	Shaft	Connector pin No.	Initially assigned device
MR-J5-_G_(-RJ_) MR-J5-_G_-LL	—	CN3-13	MBR
MR-J5-_G_-HS_	—	CN3-1B	MBR
MR-J5W2-_G_	A-axis	CN3-12	MBR-A
	B-axis	CN3-25	MBR-B
MR-J5W3-_G_	A-axis	CN3-12	MBR-A
	B-axis	CN3-25	MBR-B
	C-axis	CN3-13	MBR-C
MR-J5D1-_G_	—	CN3-32	MBR
MR-J5D2-_G_	A-axis	CN3-32	MBR-A
	B-axis	CN3-31	MBR-B
MR-J5D3-_G_	A-axis	CN3-32	MBR-A
	B-axis	CN3-31	MBR-B
	C-axis	CN3-30	MBR-C

When DB signal is selected in the device selection, the servo-off sequence at power failure changes.

[Pr. PD07.0-1_Device selection]

Initial value	Setting range	Ver.
05h	Refer to the text	A0

Refer to the following table for setting values.

Setting value	Output signal device
00	Always off
02	RD
03	ALM
04	INP
05	MBR
06 *4	DB
07	TLC
08	WNG
09	BWNG
0A	SA
0B	VLC
0C	ZSP
0E	WNGSTOP
0F	CDPS
10 *1	CLDS
11	ABSV
17	MTTR
18	CDPS2
21 *2	DOA
22 *2	DOB
23 *2	DOC
24 *3	CVST

*1 Available on servo amplifiers with firmware version A5 or later.

*2 Available on servo amplifiers with firmware version B6 or later.

*3 Available only on the MR-J5D_ _G_ . If CVST is assigned with a servo amplifier other than the MR-J5D_ _G_ , the device is always off.

*4 This device is not necessary for a servo amplifier that does not support the external dynamic brake.

[Pr. PD08_Output device selection 2 (*DO2)]

Initial value	Setting range	Setting method	Ver.
00000004h	Refer to the relevant detail No.	Common	Refer to the relevant detail No.

Select the device to be assigned to the output signal of CN3 connector. The pin numbers of the connector to be assigned are as follows.

Model	Shaft	Connector pin No.	Initially assigned device
MR-J5-G_(-RJ_) MR-J5-G_-LL	—	CN3-9	INP
MR-J5-G_-HS_	—	CN3-2A	INP
MR-J5W2-G_	A-axis	CN3-24	CINP
	B-axis		
MR-J5W3-G_	A-axis	CN3-24	CINP
	B-axis		
	C-axis		
MR-J5D1-G_	—	CN3-16	INP
MR-J5D2-G_	A-axis	CN3-16	CINP
	B-axis		
MR-J5D3-G_	A-axis	CN3-16	CINP
	B-axis		
	C-axis		

[Pr. PD08.0-1_Device selection]

Initial value	Setting range	Ver.
04h	Refer to the text	A0

Refer to the following for details of setting values.

☞ Page 104 [Pr. PD07_Output device selection 1 (*DO1)]

[Pr. PD08.2_All-axis output condition selection]

Initial value	Setting range	Ver.
0h	Refer to the text	A5

0: AND output

1: OR output

For AND output, the condition becomes significant (on or off) when the A, B, and C-axes all satisfy the condition.

The device name at this time is C_ __. (Example: CINP)

For OR output, the condition becomes significant (on or off) when any of A, B, or C-axis satisfies the condition.

The device name at this time is X_ __. (Example: XINP)

This servo parameter is enabled when [Pr. PD08.3 Output axis selection] is set to "0" (all axes) while a multi-axis servo amplifier is used.

[Pr. PD08.3_Output axis selection]

Initial value	Setting range	Ver.
0h	Refer to the text	A5

0: All axes

1: A-axis

2: B-axis

3: C-axis

If the setting value is 1, the device name is _ _ _-A. (Example: INP-A)

If the setting value is 2, the device name is _ _ _-B. (Example: INP-B)

If the setting value is 3, the device name is _ _ _-C. (Example: INP-C)

[Pr. PD09_Output device selection 3 (*DO3)]

Initial value	Setting range	Setting method	Ver.
00000003h	Refer to the relevant detail No.	Common	Refer to the relevant detail No.

Select the device to be assigned to the output signal of CN3 connector. The pin numbers of the connector to be assigned are as follows.

Model	Shaft	Connector pin No.	Initially assigned device
MR-J5-G_(-RJ_) MR-J5-G_-LL	—	CN3-15	ALM
MR-J5-G_-HS_	—	CN3-2B	ALM
MR-J5W2-G_	A-axis	CN3-11	CALM
	B-axis		
MR-J5W3-G_	A-axis	CN3-11	CALM
	B-axis		
	C-axis		
MR-J5D1-G_	—	CN3-15	ALM
MR-J5D2-G_	A-axis	CN3-15	CALM
	B-axis		
MR-J5D3-G_	A-axis	CN3-15	CALM
	B-axis		
	C-axis		

[Pr. PD09.0-1_Device selection]

Initial value	Setting range	Ver.
03h	Refer to the text	A0

Refer to the following for details of setting values.

☞ Page 104 [Pr. PD07_Output device selection 1 (*DO1)]

[Pr. PD09.2_All-axis output condition selection]

Initial value	Setting range	Ver.
0h	Refer to the text	A5

0: AND output

1: OR output

For AND output, the condition becomes significant (on or off) when the A, B, and C-axes all satisfy the condition.

The device name at this time is C_ _ _ . (Example: CINP)

For OR output, the condition becomes significant (on or off) when any of A, B, or C-axis satisfies the condition.

The device name at this time is X_ _ _ . (Example: XINP)

This servo parameter is enabled when [Pr. PD09.3 Output axis selection] is set to "0" (all axes) while a multi-axis servo amplifier is used.

[Pr. PD09.3_Output axis selection]

Initial value	Setting range	Ver.
0h	Refer to the text	A5

0: All axes

1: A-axis

2: B-axis

3: C-axis

If the setting value is 1, the device name is _ _ _ -A. (Example: INP-A)

If the setting value is 2, the device name is _ _ _ -B. (Example: INP-B)

If the setting value is 3, the device name is _ _ _ -C. (Example: INP-C)

[Pr. PD11_Input filter setting (*DIF)]

Initial value	Setting range	Setting method	Ver.
00000007h	Refer to the relevant detail No.	Common	Refer to the relevant detail No.

[Pr. PD11.0_Input signal filter selection]

Initial value	Setting range	Ver.
7h	Refer to the text	A0

Setting value	Filtering time [ms]
0	No filter
1	0.500
2	1.000
3	1.500
4	2.000
5	2.500
6	3.000
7	3.500
8	4.000
9	4.500
A	5.000
B	5.500

This filter is disabled for pins to which TPR1, TPR2, or TPR3 is assigned.

[Pr. PD12_Function selection D-1 (*DOP1)]

Initial value	Setting range	Setting method	Ver.
00000101h	Refer to the relevant detail No.	Each axis	Refer to the relevant detail No.

Set the servo motor thermistor to either enabled or disabled.

[Pr. PD12.3_Servo motor thermistor - Enabled/disabled selection]

Initial value	Setting range	Ver.
0h	Refer to the text	A0

0: Enabled

1: Disabled

This servo parameter is enabled when a servo motor with a built-in thermistor is used. When a servo motor without a thermistor is used, the servo parameter is disabled (temperature monitoring disabled/alarm disabled) regardless of the setting value.

No alarm is detected in motor-less operation.

When the temperature monitoring of the motor thermistor is disabled, "9999 °C" is displayed.

[Pr. PD13_Function selection D-2 (*DOP2)]

Initial value	Setting range	Setting method	Ver.
00000000h	Refer to the relevant detail No.	Each axis	Refer to the relevant detail No.

[Pr. PD13.2_INP output signal ON condition selection]

Initial value	Setting range	Ver.
0h	Refer to the text	A0

Select a condition for outputting INP (In-position).

This function is enabled in the cyclic synchronous position mode, profile position mode, and positioning mode (point table method).

INP (In-position) immediately after servo-on or after forced stop is canceled is off.

0: Within the in-position range

1: Within the in-position range and at the completion of command output

2: Within the in-position range, at the completion of command output, and at start signal off

Refer to the following table for details.

Setting value	INP (In-position) ON condition			
	Droop pulses < in-position range	Command output completion ^{*1}	Start signal off	
			Cyclic synchronous position mode	Profile position mode ^{*2} Positioning mode (point table method) ^{*3}
0	○	×	×	×
1	○	○	×	×
2	○	○	×	○

○: Required

×: Not required

*1 The condition for completing a command output depends on the operation mode.

<Cyclic synchronous position mode>

When a position command is not input for approximately 1 ms, the command output is considered to have been completed.

<Profile position mode or positioning mode (point table method)>

When the command remaining distance is 0, the command output is considered to have been completed.

*2 Available on servo amplifiers with firmware version A5 or later.

*3 Available on servo amplifiers with firmware version B8 or later.

[Pr. PD14_Function selection D-3 (*DOP3)]

Initial value	Setting range	Setting method	Ver.
00000000h	Refer to the relevant detail No.	Each axis	Refer to the relevant detail No.

[Pr. PD14.1_Output device status at warning occurrence]

Initial value	Setting range	Ver.
0h	Refer to the text	A0

Select ALM (Malfunction) output status at warning occurrence.

Setting value	Device status
0	<p>WNG ON OFF ALM ON OFF</p> <p>Warning occurrence</p>
1	<p>WNG ON OFF ALM ON OFF</p> <p>Warning occurrence</p>

[Pr. PD15_Driver communication setting (**IDCS)]

When the command interface of the servo amplifier is EtherCAT or EtherNet/IP, this servo parameter is not available.

Initial value	Setting range	Setting method	Ver.
00000000h	Refer to the relevant detail No.	Each axis	Refer to the relevant detail No.

[Pr. PD15.0_Master axis operation selection]

Initial value	Setting range	Ver.
0h	Refer to the text	D0

0: Disabled (master-slave operation function is not used)

1: Enabled (set this servo amplifier for the master axis)

To set the servo amplifier for the slave axis, set "0".

This servo parameter is enabled only with 1-axis servo amplifiers.

When this servo parameter is set to "1" (enabled) on a multi-axis servo amplifier, [AL. 037 Parameter error] occurs.

This servo parameter is not available for the MR-J5-_G_-LL servo amplifier.

[Pr. PD15.1_Slave axis operation selection]

Initial value	Setting range	Ver.
0h	Refer to the text	D0

0: Disabled (master-slave operation function is not used)

1: Enabled (set this servo amplifier for the slave axis)

To set the servo amplifier for the master axis, set "0".

This servo parameter is enabled only with 1-axis servo amplifiers.

When this servo parameter is set to "1" (enabled) on a multi-axis servo amplifier, [AL. 037 Parameter error] occurs.

This servo parameter is not available for the MR-J5-_G_-LL servo amplifier.

[Pr. PD22_Driver communication setting - Slave - Master axis 1 - Station No. setting (*SM1N)]

When the command interface of the servo amplifier is EtherCAT or EtherNet/IP, this servo parameter is not available.

Initial value	Setting range	Setting method	Ver.
0	0 to 255	Each axis	D0

Set the station No. of master axis 1.

This servo parameter is enabled when it is set as the slave axis (when [Pr. PD15.1] is set to "1").

When "0" is set, this servo parameter is disabled.

This servo parameter is not available for the MR-J5-_G_-LL servo amplifier.

[Pr. PD23_Driver communication setting - Slave - Master axis 1 - Transmission and receive setting (*SM1C)]

When the command interface of the servo amplifier is EtherCAT or EtherNet/IP, this servo parameter is not available.

Initial value	Setting range	Setting method	Ver.
00000000h	Refer to the relevant detail No.	Each axis	Refer to the relevant detail No.

[Pr. PD23.1_Driver communication setting - Slave - Master axis 1 - Control slave axis No. setting]

Initial value	Setting range	Ver.
0h	0h to 8h	D0

Set the control slave No. for master axis 1.

This servo parameter is enabled when it is set as the slave axis (when [Pr. PD15.1] is set to "1").

To set the servo amplifier as a control slave axis, set any value from "1" to "8". When "0" is set, this servo amplifier being used will not function as a control slave axis.

This servo parameter is not available for the MR-J5-_G_-LL servo amplifier.

[Pr. PD26_Master-slave operation simultaneous stop function operation setting (*MSTO)]

When the command interface of the servo amplifier is EtherCAT or EtherNet/IP, this servo parameter is not available.

Initial value	Setting range	Setting method	Ver.
00000000h	Refer to the relevant detail No.	Each axis	Refer to the relevant detail No.

[Pr. PD26.0_Driver communication setting - Slave - Simultaneous stop command permission setting]

Initial value	Setting range	Ver.
0h	Refer to the text	D0

Set the behavior of the slave axis for when the slave axis receives a stop command from the master axis in the master-slave operation simultaneous stop function.

This servo parameter is enabled when it is set as the slave axis (when [Pr. PD15.1] is set to "1").

0: Enabled (stops in accordance with the stop command from the master axis.)

1: Disabled (ignores the stop command from the master axis and continues the operation.)

This servo parameter is not available for the MR-J5-_G_-LL servo amplifier.

[Pr. PD26.1_Driver communication setting - Slave - Simultaneous stop request permission setting]

Initial value	Setting range	Ver.
0h	Refer to the text	D0

Set whether to enable or disable the stop request notification to the master axis in the master-slave operation simultaneous stop function.

This servo parameter is enabled when it is set as the slave axis (when [Pr. PD15.1] is set to "1").

The stop request will be notified to the master axis only when this servo amplifier being used is set as the control slave axis.

0: Enabled (notifies the master axis of a stop request when the control slave axis being used is stopped.)

1: Disabled (does not notify the master axis of a stop request when the axis is stopped.)

This servo parameter is not available for the MR-J5-_G_-LL servo amplifier.

[Pr. PD30_Master-slave operation - Slave-side torque command coefficient (TLS)]

When the command interface of the servo amplifier is EtherCAT or EtherNet/IP, this servo parameter is not available.

Initial value	Setting range	Setting method	Ver.
0 [%]	0 to 500	Each axis	C4

For the torque command value received from the master axis, set the coefficient to reflect to the internal torque command.

This servo parameter is enabled only in the slave axis torque mode (slt).

When this servo parameter is set to "100", the coefficient is multiplied by 1. The torque distribution is 100 (master): 100 (slave).

This function corresponds to [Master-slave Torque coefficient (Obj. 2E44h)].

When an object is mapped in cyclic communication, the controller overwrites the value written with engineering software.

Thus, do not write a value with engineering software.

This servo parameter is not available for the MR-J5-_G_-LL servo amplifier.

[Pr. PD31_Master-slave operation - Slave-side speed limit coefficient (VLC)]

When the command interface of the servo amplifier is EtherCAT or EtherNet/IP, this servo parameter is not available.

Initial value	Setting range	Setting method	Ver.
0 [%]	0 to 500	Each axis	C4

For the speed limit command value received from the master axis, set the coefficient to reflect to the internal speed limit value.

This servo parameter is enabled only in the slave axis torque mode (slt).

This function corresponds to [Master-slave Velocity limit coefficient (Obj. 2E45h)].

When an object is mapped in cyclic communication, the controller overwrites the value written with engineering software.

Thus, do not write a value with engineering software.

When this servo parameter is set to "100", the coefficient is multiplied by 1. The setting example is described below.

Ex.

[Pr. PD31] = "140"

[Pr. PD32] = "300" and

the master side is operated with an acceleration/deceleration of 1000 r/min:

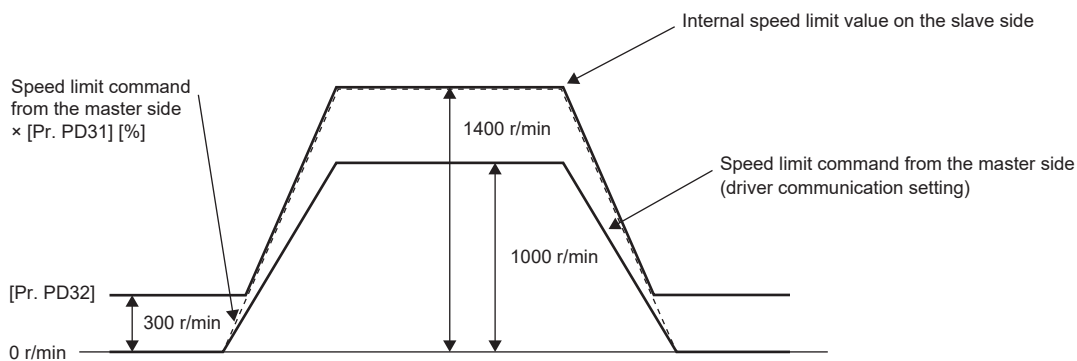

This servo parameter is not available for the MR-J5-_G_-LL servo amplifier.

[Pr. PD32_Master-slave operation - Slave-side speed limit adjusted value (VLL)]

When the command interface of the servo amplifier is EtherCAT or EtherNet/IP, this servo parameter is not available.

Initial value	Setting range	Setting method	Ver.
0.00 [r/min]	0.00 to 21474836.47	Each axis	C4

Set the minimum value of both the speed limit value and the setting value of [Pr. PD31 Master-slave operation - Slave-side speed limit coefficient].

This servo parameter ensures torque control range at low speed driving (by avoiding area likely to reach speed limit). Set to approximately 100.00 to 500.00 r/min in general. For the example settings, refer to [Pr. PD31].

☞ Page 113 [Pr. PD31_Master-slave operation - Slave-side speed limit coefficient (VLC)]

This function is enabled when [Pr. PT01.1 Speed/acceleration/deceleration unit selection] is set to "0". This function and [Pr. PV33 Master-slave operation - Speed limit adjusted value extension setting] are mutually exclusive.

The servo motor speed is clamped at the maximum speed. When changing the speed to the permissible speed, set the speed in [Pr. PA28.4 Speed range limit selection].

This function corresponds to [Master-slave Lower limit of velocity limit value (Obj. 2E46h)].

When the command interface of the servo amplifier is EtherCAT, this servo parameter is not available.

When an object is mapped in cyclic communication, the controller overwrites the value written with engineering software.

Thus, do not write a value with engineering software.

This servo parameter is not available for the MR-J5-_G_-LL servo amplifier.

[Pr. PD38_Input device selection 4 (*DI4)]

Initial value	Setting range	Setting method	Ver.
000002Ch	Refer to the relevant detail No.	Each axis	Refer to the relevant detail No.

Assign a device to the input signal of the CN3 connector. The touch probe function can be used by setting this servo parameter to TPR1 to TPR3.

The pin numbers of the connector to be assigned are as follows.

Model	Connector pin No.	Initially assigned device
MR-J5-_G_	CN3-10 *1	TPR1
MR-J5-_G_-RJ_	CN3-10	
MR-J5-_G_-HS_	CN3-4A	
MR-J5-_G_-LL	—	
MR-J5W2-_G_	—	
MR-J5W3-_G_	—	
MR-J5D1-_G_	CN3-11	
MR-J5D2-_G_	—	
MR-J5D3-_G_	—	

*1 Available on servo amplifiers with firmware version C0 or later and manufactured in June 2021 or later.

If duplicated input devices (TPR1 to TPR3) exist in [Pr. PD05 Input device selection 1], [Pr. PD38 Input device selection 4] and [Pr. PD39 Input device selection 5], [AL. 037 Parameter error] occurs.

Ex.

When TPR1 is duplicated, such as when [Pr. PD05.0] = "2Ch" (TPR1) and [Pr. PD38.0] = "2Ch" (TPR1)

[Pr. PD38.0-1_Device selection]

Initial value	Setting range	Ver.
2Ch	Refer to the text	A0

Refer to the following for setting values.

☞ Page 100 [Pr. PD03_Input device selection 1 (*DI1)]

[Pr. PD39_Input device selection 5 (*DI5)]

Initial value	Setting range	Setting method	Ver.
0000002Dh	Refer to the relevant detail No.	Each axis	Refer to the relevant detail No.

Assign a device to the input signal of the CN3 connector. The touch probe function can be used by setting this servo parameter to TPR1 to TPR3.

The pin numbers of the connector to be assigned are as follows.

Model	Connector pin No.	Initially assigned device
MR-J5-_G_	CN3-1 *1	TPR2
MR-J5-_G_-RJ_	CN3-1	
MR-J5-_G_-HS_	CN3-4B	
MR-J5-_G_-LL	CN3-1	
MR-J5W2-_G_	—	
MR-J5W3-_G_	—	
MR-J5D1-_G_	CN3-27	
MR-J5D2-_G_	—	
MR-J5D3-_G_	—	

*1 Available on servo amplifiers with firmware version C0 or later and manufactured in June 2021 or later.

If duplicated input devices (TPR1 to TPR3) exist in [Pr. PD05 Input device selection 1], [Pr. PD38 Input device selection 4] and [Pr. PD39 Input device selection 5], [AL. 037 Parameter error] occurs.

Ex.

When TPR1 is duplicated, such as when [Pr. PD05.0] = "2Ch" (TPR1) and [Pr. PD38.0] = "2Ch" (TPR1)

[Pr. PD39.0-1_Device selection]

Initial value	Setting range	Ver.
2Dh	Refer to the text	A0

Refer to the following for setting values.

☞ Page 100 [Pr. PD03_Input device selection 1 (*DI1)]

[Pr. PD41_Function selection D-4 (*DOP4)]

Initial value	Setting range	Setting method	Ver.
00000000h	Refer to the relevant detail No.	Each axis	Refer to the relevant detail No.

[Pr. PD41.2_Limit switch enabled status selection]

Initial value	Setting range	Ver.
0h	Refer to the text	A0

0: Limit switch always enabled

1: Enabled only for homing mode

If "1" is set, the limit switches during servo motor operation are disabled. To prevent a collision, do not use the limit switch unless the stroke limit is controlled from the controller. The status of the limit switches (S_FLS and S_RLS) is returned.

Even if "1" is set, the limit switches are enabled during the test operation and at magnetic pole detection.

Set "1" if the controller is a Mitsubishi Electric motion module.

[Pr. PD41.3_Sensor input method selection]

Initial value	Setting range	Ver.
0h	Refer to the text	A0

Select the input method for the proximity dog and limit switches.

0: Input from servo amplifier (LSP/LSN/DOG)

1: Input from controller (C_FLS/C_RLS/C_DOG)

When selecting "0", wire the limit switch installed in CCW direction to LSP, and wire the limit switch installed in CW direction to LSN. If the limit switches are wired in the opposite direction, the servo motor will not stop with the limit switches.

When selecting "1", set the limit switch installed in position address increasing direction to C_FLS, and the limit switch installed in decreasing direction to C_RLS. After that, input the limit signals from the controller. If the limit switches are wired in the opposite direction, the servo motor will not stop with the limit switches.

[Pr. PD51_Input device selection 3-2 (*DI3W2)]

Initial value	Setting range	Setting method	Ver.
00000062h	Refer to the relevant detail No.	Common	Refer to the relevant detail No.

Select the device to be assigned to the input signal of the CN3-15 pin of the MR-J5W2-_G_ or the CN3-11 pin of the MR-J5D2-_G_.

This servo parameter is enabled only for the MR-J5W2-_G_ and MR-J5D2-_G_. The setting value is disabled for other servo amplifiers.

Model	Shaft	Connector pin No.	Initially assigned device
MR-J5W2-G_	A-axis	CN3-15	TPR3-A
	B-axis		
MR-J5D2-_G_	A-axis	CN3-11	—
	B-axis		

[Pr. PD51.0-1_Device selection 3-2]

Initial value	Setting range	Ver.
62h	Refer to the text	A5

Refer to the following table for the setting value to be assigned to the CN3-15 pin of the MR-J5W2-_G_ or the CN3-11 pin of the MR-J5D2-_G_.

Setting value	Input signal device
2C	TPR1
2D	TPR2
62	No assigned function
63	TPR3

[Pr. PD51.4_Input axis selection 3-2]

Initial value	Setting range	Ver.
0h	Refer to the text	A5

For the MR-J5W2-G_, set which axis will use the input device that was assigned in [Pr. PD05.0-1 Device selection].

When this servo parameter is "0h", the A-axis is automatically set to be enabled.

Servo parameter number	Setting digit (BIN)	Setting details
[Pr. PD51.4]	___x	A-axis selection 0: Disabled 1: Enabled
	__x_	B-axis selection 0: Disabled 1: Enabled

When A-axis selection is enabled, the device name is ___-A. (Example: TPR1-A)

When B-axis selection is enabled, the device name is ___-B. (Example: TPR1-B)

When multiple axes are enabled with this servo parameter, the input device signal is enabled for multiple axes simultaneously. In the following cases, [AL. 037 Parameter error] occurs.

- When other than "0h" is set for a 1-axis servo amplifier
- When duplicated input devices exist  Page 117 Example of duplicated settings

■Example of duplicated settings

When TPR1-B is duplicated, such as when for the A axis, [Pr. PD05.4] = "3h" (A and B axes enabled) and [Pr. PD05.0] = "2Ch" (TPR1); and for the B axis, [Pr. PD05.4] = "0h" (automatic setting: B axis enabled) and [Pr. PD05.0] = "2Ch" (TPR1)

[Pr. PD60_DI pin polarity selection (*DIP)]

Initial value	Setting range	Setting method	Ver.
0000000h	Refer to the relevant detail No.	Each axis	Refer to the relevant detail No.

For DI pin numbers corresponding to setting digits, refer to the following table.

If this servo parameter is set incorrectly, [AL. 037 Parameter error] may occur.

If the setting digit (BIN) of the DI pin to which TPR1 to TPR3 are assigned is set to "1", [AL. 037] occurs.

- MR-J5-_G_/MR-J5W_-_G_

Servo parameter number	Setting digit (BIN)	Name	Model						
			MR-J5-_G_	MR-J5-_G_-RJ_	MR-J5-_G_-HS_	MR-J5-_G_-LL	MR-J5W_-_G_		
							A-axis	B-axis	C-axis
[Pr. PD60.0]	___x	DI pin polarity selection 1	CN3-2	CN3-2	CN3-5A	CN3-2	CN3-7	CN3-20	CN3-1
	__x_	DI pin polarity selection 2	CN3-12	CN3-12	CN3-5B	CN3-12	CN3-8	CN3-21	CN3-2
	_x__	DI pin polarity selection 3	CN3-19	CN3-19	CN3-6B	CN3-19	CN3-9	CN3-22	CN3-15
	x___	DI pin polarity selection 4	CN3-10 ^{*1}	CN3-10	CN3-4A	—	—	—	—
[Pr. PD60.1]	___x	DI pin polarity selection 5	CN3-1 ^{*1}	CN3-1	CN3-4B	CN3-1	—	—	—
	__x_	For manufacturer setting	—	—	—	—	—	—	—
	_x__	For manufacturer setting	—	—	—	—	—	—	—
	x___	For manufacturer setting	—	—	—	—	—	—	—

*1 Available on servo amplifiers with firmware version C0 or later and manufactured in June 2021 or later.

- MR-J5D_-_G_

Servo parameter number	Setting digit (BIN)	Name	Model			
			MR-J5D1-_G_	MR-J5D2-_G_/MR-J5D3-_G_		
				A-axis	B-axis	C-axis
[Pr. PD60.0]	___x	DI pin polarity selection 1	CN3-12	CN3-12	CN3-26	CN3-10
	__x_	DI pin polarity selection 2	CN3-28	CN3-28	CN3-25	CN3-9
	_x__	DI pin polarity selection 3	CN3-29	CN3-29	CN3-27	CN3-11
	x___	DI pin polarity selection 4	CN3-11	—	—	—
[Pr. PD60.1]	___x	DI pin polarity selection 5	CN3-27	—	—	—
	__x_	For manufacturer setting	—	—	—	—
	_x__	For manufacturer setting	—	—	—	—
	x___	For manufacturer setting	—	—	—	—

[Pr. PD60.0_DI pin polarity selection]

Initial value	Setting range	Ver.
0h	Refer to the text	A5

Select the DI pin polarity.

Setting digit (BIN)	Functions
___x	DI pin polarity selection 1 0: ON with 24 V input 1: ON with 0 V input
__x_	DI pin polarity selection 2 0: ON with 24 V input 1: ON with 0 V input
_x__	DI pin polarity selection 3 0: ON with 24 V input 1: ON with 0 V input
x___	DI pin polarity selection 4 0: ON with 24 V input 1: ON with 0 V input

[Pr. PD60.1_DI pin polarity selection]

Initial value	Setting range	Ver.
0h	Refer to the text	A5

Select the DI pin polarity.

Setting digit (BIN)	Functions
___x	DI pin polarity selection 5 0: ON with 24 V input 1: ON with 0 V input
__x_	For manufacturer setting
_x__	For manufacturer setting
x___	For manufacturer setting

[Pr. PD60.2_For manufacturer setting]

This servo parameter is for manufacturer setting.

[Pr. PD60.3_For manufacturer setting]

This servo parameter is for manufacturer setting.

[Pr. PD60.4_For manufacturer setting]

This servo parameter is for manufacturer setting.

[Pr. PD60.5_For manufacturer setting]

This servo parameter is for manufacturer setting.

[Pr. PD60.6_For manufacturer setting]

This servo parameter is for manufacturer setting.

[Pr. PD60.7_For manufacturer setting]

This servo parameter is for manufacturer setting.

[Pr. PD61_Function selection D-5 (*DOP5)]

Initial value	Setting range	Setting method	Ver.
00000000h	00000000h to 0000017Fh	Each axis	Refer to the relevant detail No.

[Pr. PD61.2_[AL. 069 Command error] output selection with absolute position erased]

Initial value	Setting range	Ver.
0h	0h to 1h	E4

Enable or disable the absolute position erased (ABSV) output at occurrence of [AL. 069 Command error].

0: Disabled

1: Enabled

If this servo parameter is set to "1" (enabled), ABSV turns on at occurrence of [AL. 069 Command error].

1.6 Extension setting 2 servo parameters group ([Pr. PE_ _])

[Pr. PE01_Fully closed loop control function selection 1 (**FCT1)]

Initial value	Setting range	Setting method	Ver.
00000000h	Refer to the relevant detail No.	Each axis	Refer to the relevant detail No.

[Pr. PE01.0_Fully closed loop function selection]

Initial value	Setting range	Ver.
0h	Refer to the text	A5

Select the fully closed loop function.

This servo parameter is enabled when [Pr. PA01.4 Fully closed loop operation mode selection] is set to "1" (enabled (fully closed loop control mode)).

If this servo parameter is set to "1" while [Pr. PA03.0 Absolute position detection system selection] has been set to "1" (enabled (absolute position detection system)), [AL. 037 Parameter error].

If semi-closed loop control/fully closed loop control switching is performed during operation in the homing mode or the profile position mode while this servo parameter is set to "1", [AL. 0F4.A Fully closed loop control - Switching warning] occurs. In this case, the control method does not switch to the selected control method while the operation is in progress.

When the positioning mode (point table method) is selected, setting this servo parameter to "1" triggers [AL. 037].

0: Always enabled

1: Switching by "fully closed loop selection" from the controller (C_CLD) and by the input device "fully closed loop selection" (CLD)

Fully closed loop selection		Control method
Command from controller (C_CLD)	CLD (fully closed loop selection) *1	
OFF	OFF	Semi closed loop control
ON	OFF	
OFF	ON	Fully closed loop control
ON	ON	

*1 This is always off if CLD (fully closed loop selection) is not assigned to an input device pin.

This servo parameter is not available for the MR-J5-_G_-LL servo amplifier.

[Pr. PE01.4_Fully closed loop control - Droop pulse clear enable/disable selection]

Initial value	Setting range	Ver.
0h	Refer to the text	D4

When switching between semi closed loop control and fully closed loop control is performed, select whether to clear droop pulses.

0: Enabled

1: Disabled

When the setting value of this servo parameter is "0" (enabled), switching the semi closed loop control to the fully closed loop control clears the load-side droop pulses. In addition, switching the fully closed loop control to the semi closed loop control clears the motor-side droop pulses. For these reasons, shock is reduced at switching between semi closed loop control and fully closed loop control.

When the setting value of this servo parameter is "1" (disabled), perform switching between semi closed loop control and fully closed loop control with the motor-side and the load-side connected. If the switching between semi closed loop control and fully closed loop control is performed when the motor-side and the load-side are not connected, the servo motor may cause an unexpected operation such as sudden acceleration.

This servo parameter is not available for the MR-J5-_G_-LL servo amplifier.

[Pr. PE03_Fully closed loop control function selection 2 (*FCT2)]

Initial value	Setting range	Setting method	Ver.
00000003h	Refer to the relevant detail No.	Each axis	Refer to the relevant detail No.

[Pr. PE03.0_Fully closed loop control error - Detection function selection]

Initial value	Setting range	Ver.
3h	Refer to the text	A5

0: Disabled

1: Speed deviation error detection

2: Position deviation error detection

3: Speed deviation error detection and position deviation error detection

Refer to the following table for the combination with [Pr. PE03.1 Position deviation error - Detection method selection].

○: Error detection enabled —: Error detection disabled

Setting value		Speed deviation error	Position deviation error		
[Pr. PE03.1]	[Pr. PE03.0]		In servo-on state		In servo-off state
			With commands	No commands (= 0)	
0	0	—	—	—	—
0	1	○	—	—	—
0	2	—	○	○	○
0	3	○	○	○	○
1	0	—	—	—	—
1	1	○	—	—	—
1	2	—	—	○	—
1	3	○	—	○	—
2	0	—	—	—	—
2	1	○	—	—	—
2	2	—	—	○	○
2	3	○	—	○	○

This servo parameter is not available for the MR-J5-_G_-LL servo amplifier.

[Pr. PE03.1_Position deviation error - Detection method selection]

Initial value	Setting range	Ver.
0h	Refer to the text	A5

0: Continuous detection

1: Detection only at stop (An error is detected if the command is "0".)

2: Detection only at stop 2 (An error is detected during servo-off or if the command is "0" while in servo-on state.)

Refer to the following table for the combination with [Pr. PE03.0 Fully closed loop control error - Detection function selection].

☞ Page 122 [Pr. PE03.0_Fully closed loop control error - Detection function selection]

This servo parameter is not available for the MR-J5-_G_-LL servo amplifier.

[Pr. PE03.3_Fully closed loop control error - Reset selection]

Initial value	Setting range	Ver.
0h	Refer to the text	A5

0: Reset disabled (reset by cycling the power or software reset)

1: Reset enabled

This servo parameter is not available for the MR-J5-_G_-LL servo amplifier.

[Pr. PE04_Fully closed loop control - Feedback pulse electronic gear 1 - Numerator (**FBN)]

Initial value	Setting range	Setting method	Ver.
1	1 to 4294967295	Each axis	A5

If using the fully closed loop control, set the electronic gear numerator to the servo motor encoder pulses. Set the electronic gear so that the number of the servo motor encoder pulses per servo motor revolution is converted into load-side encoder resolution. If the reduced electronic gear numerator exceeds 2147483648 (31 bits), [AL. 037 Parameter error] occurs. This servo parameter is not available for the MR-J5-_G_-LL servo amplifier.

[Pr. PE05_Fully closed loop control - Feedback pulse electronic gear 1 - Denominator (**FBD)]

Initial value	Setting range	Setting method	Ver.
1	1 to 4294967295	Each axis	A5

If using the fully closed loop control, set the electronic gear denominator to the servo motor encoder pulses. Set the electronic gear so that the number of the servo motor encoder pulses per servo motor revolution is converted into load-side encoder resolution. If the reduced electronic gear denominator exceeds 1073741824 (30 bits), [AL. 037 Parameter error] occurs. This servo parameter is not available for the MR-J5-_G_-LL servo amplifier.

[Pr. PE06_Fully closed loop control - Speed deviation error detection level (BC1)]

Initial value	Setting range	Setting method	Ver.
400 [r/min]	1 to 50000	Each axis	A5

Set the detection level for triggering [AL. 042.9 Fully closed loop control error based on speed deviation] of the fully closed loop control error detection. If the difference between the speed calculated by the servo motor encoder and the speed calculated by the load-side encoder exceeds the value of this servo parameter, the alarm occurs. This servo parameter is not available for the MR-J5-_G_-LL servo amplifier.

[Pr. PE07_Fully closed loop control - Position deviation error detection level (BC2)]

Initial value	Setting range	Setting method	Ver.
100 [kpulse]	1 to 20000	Each axis	A5

Set the detection level for triggering [AL. 042.8 Fully closed loop control error based on position deviation] of the fully closed loop control error detection. If the difference between the position of the servo motor encoder and the position of the load-side encoder exceeds the value of this servo parameter, the alarm occurs. This servo parameter is not available for the MR-J5-_G_-LL servo amplifier.

[Pr. PE08_Fully closed loop dual feedback filter (DUF)]

Initial value	Setting range	Setting method	Ver.
10 [rad/s]	1 to 4500	Each axis	A5

Set a dual feedback filter band. This servo parameter is not available for the MR-J5-_G_-LL servo amplifier.

[Pr. PE10_Fully closed loop function selection 3 (FCT3)]

Initial value	Setting range	Setting method	Ver.
00000000h	Refer to the relevant detail No.	Each axis	Refer to the relevant detail No.

[Pr. PE10.1_Fully closed loop control - Position deviation error detection level - Unit selection]

Initial value	Setting range	Ver.
0h	Refer to the text	A5

0: 1 kpulse unit

1: 1 pulse unit

This servo parameter is not available for the MR-J5-_G_-LL servo amplifier.

[Pr. PE41_Function selection E-3 (EOP3)]

Initial value	Setting range	Setting method	Ver.
00000000h	Refer to the relevant detail No.	Each axis	Refer to the relevant detail No.

[Pr. PE41.0_Robust filter selection]

Initial value	Setting range	Ver.
0h	Refer to the text	A0

0: Disabled

1: Enabled

When this setting value is set to "Enabled", the machine resonance suppression filter 5 set in [Pr. PB51 Notch shape selection 5] cannot be used.

[Pr. PE41.6_Unbalanced torque offset setting selection]

Initial value	Setting range	Ver.
0h	Refer to the text	A0

0: Manual setting

1: Automatic setting

If "1" (automatic setting) has been set and friction estimation by the machine diagnosis function has completed for both the forward and reverse rotations, the value of [Pr. PE47 Unbalanced torque offset] will be set automatically according to the estimated friction value. After [Pr. PE47] is set automatically, this servo parameter changes to "0" (Manual setting). The value of [Pr. PE47] will not be set automatically and this servo parameter keeps the value "1" (automatic setting) until friction estimation completes for both the forward and reverse rotations.

[Pr. PE44_Lost motion compensation positive-side compensation value selection (LMCP)]

Initial value	Setting range	Setting method	Ver.
0 [0.01 %]	0 to 30000	Each axis	A0

Set the lost motion compensation for when negative speed switches to positive speed in increments of 0.01 % in relation to the rated torque as 100 %.

This function is enabled in the position mode and positioning mode.

[Pr. PE45_Lost motion compensation negative-side compensation value selection (LMCN)]

Initial value	Setting range	Setting method	Ver.
0 [0.01 %]	0 to 30000	Each axis	A0

Set the lost motion compensation for when positive speed switches to negative speed in increments of 0.01 % in relation to the rated torque as 100 %.

This function is enabled in the position mode and positioning mode.

[Pr. PE46_Lost motion filter setting (LMFLT)]

Initial value	Setting range	Setting method	Ver.
0 [0.1 ms]	0 to 30000	Each axis	A0

When "0" is set, the value is compensated with the compensation amount of the value that was set in [Pr. PE44 Lost motion compensation positive-side compensation value selection] and [Pr. PE45 Lost motion compensation negative-side compensation value selection]. When a value other than "0" is set, the torque is compensated with the high-pass filter output value of the set time constant, and the lost motion compensation will continue.

This function is enabled in the position mode and positioning mode.

[Pr. PE47_Unbalanced torque offset (TOF)]

Initial value	Setting range	Setting method	Ver.
0 [0.01 %]	-10000 to 10000	Each axis	A0

Set this to cancel the unbalanced torque of a vertical axis. Set this in relation to the rated torque of the servo motor as 100 %. The torque offset does not need to be set for a machine that does not generate unbalanced torque. This servo parameter can be used in applications where an unbalanced torque is generated constantly, such as when a linear servo motor or direct drive motor is operated horizontally with tension applied in one direction.

The torque offset that has been set with this servo parameter is enabled in any control mode. In the torque mode, input commands taking the torque offset into account.

This servo parameter is suitable when the torque offset does not need to be changed dynamically.

[Pr. PE48_Lost motion compensation function selection (*LMOP)]

Initial value	Setting range	Setting method	Ver.
00000000h	Refer to the relevant detail No.	Each axis	Refer to the relevant detail No.

This function is enabled in the position mode and positioning mode.

[Pr. PE48.0_Lost motion compensation type selection]

Initial value	Setting range	Ver.
0h	Refer to the text	A0

0: Lost motion compensation disabled

1: Lost motion compensation enabled

[Pr. PE48.1_Lost motion compensation dead band unit setting]

Initial value	Setting range	Ver.
0h	Refer to the text	A0

0: 1 pulse unit

1: 1 kpulse unit

[Pr. PE49_Lost motion compensation timing (LMCD)]

Initial value	Setting range	Setting method	Ver.
0 [0.1 ms]	0 to 30000	Each axis	A0

Set the lost motion compensation timing in units of 0.1 ms.

The timing to perform the lost motion compensation function can be delayed by a set time.

This function is enabled in the position mode and positioning mode.

[Pr. PE50_Lost motion compensation dead band (LMCT)]

Initial value	Setting range	Setting method	Ver.
0 [pulse], [kpulse]	0 to 65535	Each axis	A0

Set the lost motion compensation dead band. When the fluctuation of droop pulses is equal to or less than the setting value, the speed is recognized as 0. The setting unit can be changed with [Pr. PE48 Lost motion compensation function selection].

Set the servo parameter per encoder unit.

This function is enabled in the position mode and positioning mode.

[Pr. PE51_Load-side encoder resolution setting (**EDV2)]

Initial value	Setting range	Setting method	Ver.
0 [pulse]	0 to 4294967295	Each axis	B2

When the fully closed loop control mode or the scale measurement function is enabled, the encoder is recognized as an A/B/Z-phase differential output rotary encoder by setting a load-side encoder resolution in this servo parameter with the A/B/Z-phase differential output rotary encoder connected to the load-side. At this time, the cycle counter is displayed. A load-side encoder resolution is the number of pulses output when the encoder is rotated by one revolution.

When "0" is set in this servo parameter, the encoder is recognized as an A/B/Z-phase differential output linear encoder. At this time, the Z-phase counter (the distance from the linear encoder home position (Z-phase)) is displayed after the Z-phase is passed.

When the resolution set in this servo parameter is either less than 2^{12} or greater than 2^{26} , [AL. 037 Parameter error] occurs.

As shown in the following figures, the display of the load-side encoder information 1 monitor changes depending on the setting value of this servo parameter.

- When "0" is set in [Pr. PE51]

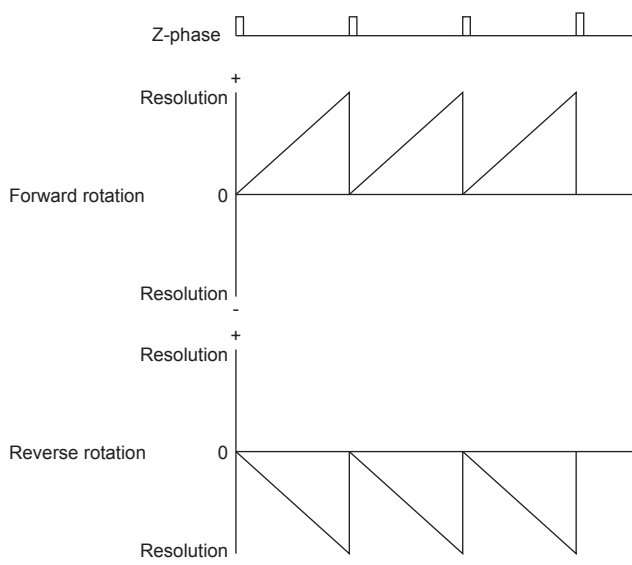

- When a load-side encoder resolution is set in [Pr. PE51]

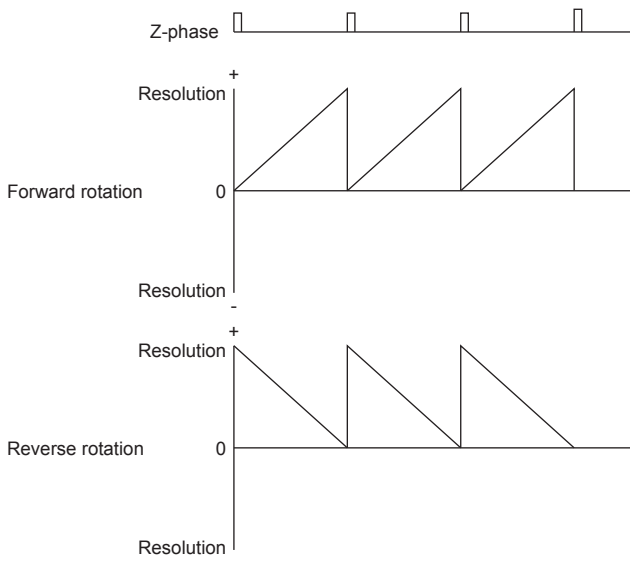

This servo parameter is not available for the MR-J5-_G_-LL servo amplifier.

[Pr. PE53_Maximum torque limit 1 (TLMX1)]

Initial value		Setting range	Setting method	Ver.
J5G	J5G-N1			
0.0 [%]	1000.0 [%]	0.0 to 1000.0	Each axis	A5

The torque or thrust generated by the servo motor can be limited.

When [Pr. PC78.1 Maximum torque limit 1 selection] is set to "0" (the maximum torque limit 1 is disabled)

The torque limit function using this servo parameter or [Max torque (Obj. 6072h)] is disabled.

The setting value of this servo parameter does not match the setting value of [Max torque (Obj. 6072h)].

[Max torque (Obj. 6072h)] returns the maximum torque of the servo motor.

When [Pr. PC78.1] is set to "1" (the maximum torque limit 1 is enabled)

The torque limit function using this servo parameter or [Max torque (Obj. 6072h)] is enabled.

Set this servo parameter in relation to the rated torque or continuous thrust (= 100.0 %).

If this servo parameter is set to "0.0", the servo motor does not generate torque or thrust.

This servo parameter corresponds to [Max torque (Obj. 6072h)].

When an object is mapped in cyclic communication, the controller overwrites the value written with engineering software.

Thus, do not write a value with engineering software.

1.7 Extension setting 3 servo parameters group ([Pr. PF_ _])

[Pr. PF02_Function selection F-2 (*FOP2)]

Initial value	Setting range	Setting method	Ver.
00000000h	Refer to the relevant detail No.	Common	Refer to the relevant detail No.

[Pr. PF02.0_Target alarm selection of the other axis error warning]

Initial value	Setting range	Ver.
0h	Refer to the text	A0

Select target alarms of the other axis error warning.

For alarms occurring at all axes, [AL. 0EB The other axis error warning] will not occur regardless of alarm No.

[AL. 0EB The other axis error warning] does not occur in 1-axis servo amplifiers.

0: [AL. 024 Main circuit error], [AL. 032 Overcurrent]

1: All alarms

[Pr. PF02.4_Memory writing frequency warning enable/disable selection]

Initial value	Setting range	Ver.
0h	Refer to the text	A0

Enable or disable [AL. 1F8.1 Memory writing frequency warning].

[AL. 1F8.1] indicates that the memory writing frequency has exceeded the guaranteed number of times.

If the servo amplifier continues to be used while the alarm is disabled with this servo parameter, the memory may be corrupted and restoration of the data, such as servo parameters, may fail.

0: Enabled

1: Disabled

[Pr. PF02.5_Memory free space warning enable/disable selection]

Initial value	Setting range	Ver.
0h	Refer to the text	A0

Select whether to enable or disable [AL. 1F8.2 Memory free space warning].

[AL. 1F8.2] indicates that the memory free space is running low.

If the servo amplifier continues to be used while the alarm is disabled with this servo parameter, [AL. 119.7 Memory free space 4-1] may occur and data restoration may fail.

0: Enabled

1: Disabled

[Pr. PF06_Function selection F-5 (*FOP5)]

Initial value	Setting range	Setting method	Ver.
00000013h	Refer to the relevant detail No.	Each axis	Refer to the relevant detail No.

[Pr. PF06.0_Electronic dynamic brake selection]

Initial value	Setting range	Ver.
3h	Refer to the text	A0

Enable or disable the electronic dynamic brake.

2: Disabled

3: Enabled only for specific servo motors

For specific servo motors, refer to "Precautions relating to the dynamic brake characteristics" in the User's Manual (Hardware).

[Pr. PF06.1_STO timing error selection]

Initial value	Setting range	Ver.
1h	Refer to the text	A0

Select whether [AL. 063 STO timing error] is detected.

0: Detected.

1: Not detected.

If the STO status is set at the servo motor speed shown below while "0" (detected) has been selected, [AL. 063 STO timing error] will be detected. The STO status means the status where STO1 or STO2 of CN8 has been turned off.

- Servo motor speed: 50 r/min or higher
- Linear servo motor speed: 50 mm/s or higher
- Direct drive motor speed: 5 r/min or higher

[Pr. PF12_Electronic dynamic brake operating time (DBT)]

Initial value	Setting range	Setting method	Ver.
2000 [ms]	0 to 10000	Each axis	A0

Set an operating time for the electronic dynamic brake.

[Pr. PF18_STO diagnosis error detection time (**STOD)]

Initial value	Setting range	Setting method	Ver.
10 [s]	0 to 60	Common	A0

Set the time from when the error of the STO input or STO circuit is detected until the occurrence of [AL. 068.1 STO signal mismatch error].

When "0" is set, [AL. 068.1] is not detected.

The safety level depends on the setting value of this servo parameter and whether STO input diagnosis is performed by TOFB output as shown in the following table.

Setting value	STO input diagnosis by TOFB output	Safety level
0	Execute	EN ISO 13849-1: 2015 Category 3 PL d, IEC 61508 SIL 2, and EN IEC 62061 maximum SIL 2
	Do not execute	
1 to 60	Execute	EN ISO 13849-1: 2015 Category 3 PL e, IEC 61508 SIL 3, and EN IEC 62061 maximum SIL 3
	Do not execute	EN ISO 13849-1: 2015 Category 3 PL d, IEC 61508 SIL 2, and EN IEC 62061 maximum SIL 2

When the STO function is not used with the short-circuit connector connected to the CN8 connector, the safety level does not change even after setting this servo parameter.

This servo parameter cannot be used with the MR-J5-_G_-RJ, MR-J5-_G_-HS_, MR-J5W-_G_, or MR-J5D_-_G_.

The alarm occurs when an STO input error is detected.

Refer to the following table for details.

Model	Firmware version	Setting of [Pr. PSA01.0]	Parameter to be used	Time required for alarm to occur	Alarm to occur
MR-J5-_G_	Servo amplifiers with version A0 or later	—	[Pr. PF18]	0 to 60 s	[AL. 068.1]
MR-J5-_G_-RJ_ MR-J5-_G_-HS_ MR-J5W-_G_ MR-J5D_-_G_	Servo amplifiers with versions earlier than B2	—	—	Fixed to 10 s	[AL. 557]
	Servo amplifiers with version B2 or later	0: Disabled	—	Fixed to 10 s	[AL. 557]
		1: Enabled	[Pr. PSD18]	0 to 60000 ms	[AL. 557]

☞ Page 261 [Pr. PSA01.0_Safety sub-function activation setting]

☞ Page 287 [Pr. PSD18_Permissible time for mismatches DI1 (**SDIDT1)]

[Pr. PF19_Friction failure prediction - Compensation coefficient 1 (TSL)]

Initial value	Setting range	Setting method	Ver.
0 [0.0001 %/°C]	-32768 to 32767	Each axis	A0

Set compensation coefficient 1 to compensate the dynamic friction being used for the friction failure prediction.

When the friction failure prediction warning selection is set to the automatic threshold setting, the value will be calculated automatically from the estimated dynamic friction.

When performing threshold manual setting on an equipment for which the threshold setting has been made once, set the value that has been calculated by the threshold automatic setting.

Setting this servo parameter decreases the possibility of erroneous detection of friction failure prediction, even with the manual threshold setting.

[Pr. PF20_Friction failure prediction - Compensation coefficient 2 (TIC)]

Initial value	Setting range	Setting method	Ver.
0 [0.1 %]	-10000 to 10000	Each axis	A0

Set compensation coefficient 2 to compensate the dynamic friction being used for the friction failure prediction.

When the friction failure prediction warning selection is set to the automatic threshold setting, the value will be calculated automatically from the estimated dynamic friction.

When performing threshold manual setting on an equipment for which the threshold setting has been made once, set the value that has been calculated by the threshold automatic setting.

Setting this servo parameter decreases the possibility of erroneous detection of friction failure prediction, even with the manual threshold setting.

[Pr. PF21_Drive recorder switching time setting (DRT)]

Initial value	Setting range	Setting method	Ver.
0 [s]	-1 to 32767	Common	A0

Set the drive recorder switching time.

When communication is shut off during the use of a graph function, the function will be switched to the drive recorder function after the time set in this servo parameter has passed.

In the following cases during the use of a graph function, the function may be automatically switched to the drive recorder function after the time set in this servo parameter has passed.

- The trigger waiting time is longer than the time set in this servo parameter.
- The waveform data reading time is longer than the time set in this servo parameter.

In the following cases, review the setting value of this servo parameter.

- A communication error occurs after the start of graph measurement.
- The graph measurement is not finished.

When any value of "10" to "32767" is set, the drive recorder function will be switched after the time set in this servo parameter has passed.

When any value of "0" to "9" is set, the drive recorder function will be switched after 10 s.

When "-1" is set, the drive recorder function is disabled.

[Pr. PF23_Vibration tough drive - Oscillation detection level (OSCL1)]

Initial value	Setting range	Setting method	Ver.
20 [%]	0 to 100	Each axis	A0

Set the oscillation detection level for readjusting the machine resonance suppression filter while the vibration tough drive is enabled.

When the oscillation level is higher than the setting value of this servo parameter, reset [Pr. PB13 Machine resonance suppression filter 1] or [Pr. PB15 Machine resonance suppression filter 2].

When "0" is set, the oscillation detection level is 20 %.

[Pr. PF24_Function selection F-9 (*FOP9)]

Initial value	Setting range	Setting method	Ver.
00000000h	Refer to the relevant detail No.	Each axis	Refer to the relevant detail No.

[Pr. PF24.0_Oscillation detection alarm selection]

Initial value	Setting range	Ver.
0h	Refer to the text	A0

Select the alarm output at oscillation detection.

Select whether to generate an alarm or a warning when an oscillation continues at a level set in [Pr. PF23 Vibration tough drive - Oscillation detection level].

This function is enabled regardless of the setting of [Pr. PA20.1 Vibration tough drive selection].

0: Alarm ([AL. 054 Oscillation detection])

1: Warning ([AL. 0F3.1 Oscillation detection warning])

2: Oscillation detection function disabled (oscillation detection not processed)

[Pr. PF25_SEMI-F47 function - Instantaneous power failure detection time (Instantaneous power failure tough drive detection time) (CVAT)]

Initial value	Setting range	Setting method	Ver.
200 [ms]	30 to 500	Common	A0

Set the time until the occurrence of [AL. 010.1 Voltage drop in the control circuit power].

To comply with SEMI-F47 standard, it is not required to change the time from the initial value (200 ms).

When the instantaneous power failure time exceeds 200 ms, and the instantaneous power failure voltage is less than 70 % of the rated input voltage, the power may be turned off normally even if a value larger than 200 ms is set in this servo parameter. This function is disabled when [Pr. PA20.2 SEMI-F47 function selection] is set to "0" (disabled).

When a common bus connection using a servo amplifier with a capacity of 12 kW to 25 kW as the main unit is constructed, it cannot comply with the SEMI-F47 standard even if [Pr. PA20.2] is set to "1" (enabled) and this servo parameter is set. For details, refer to "Common bus connection system using an MR-J5 servo amplifier with a capacity of 12 kW or more as the main unit" in the User's Manual (Hardware) or "Compliance with SEMI-F47 standard" in the User's Manual (Function).

[Pr. PF29_Function selection F-10 (*FOP10)]

Initial value	Setting range	Setting method	Ver.
00000000h	Refer to the relevant detail No.	Each axis	Refer to the relevant detail No.

[Pr. PF29.1_State selection with forced stop in progress]

Initial value	Setting range	Ver.
0h	Refer to the text	B2

Select the PDS state transition for when the forced stop is in progress.

When the servo amplifier detects the forced stop signal off during servo motor rotation, the PDS state transition destination can be selected.

0: Operation enabled

1: Quick stop active

[Pr. PF31_Machine diagnosis function - Friction estimate area judgment speed at low speed (FRIC)]

Initial value	Setting range	Setting method	Ver.
0 [r/min], [mm/s]	0 to 65535	Each axis	A0

Set the servo motor speed to divide the friction estimation area between low-speed and high-speed in the friction estimation process of machine diagnosis.

When the maximum operation speed is under the rated speed, it is recommended to set half the value of the maximum operation speed.

When "0" is set, the judgment speed is half of the rated speed.

The setting value will be clamped at the permissible maximum speed.

By setting [Pr. PF34.6 Friction estimate area judgment speed setting] to "1" (automatic setting), this servo parameter value will be automatically calculated from the operation pattern during servo motor driving and overwrite the value.

Set a value larger than [Pr. PC07 Zero speed] for this servo parameter. If the value is equal to or lower than zero speed, the friction estimation process does not function.

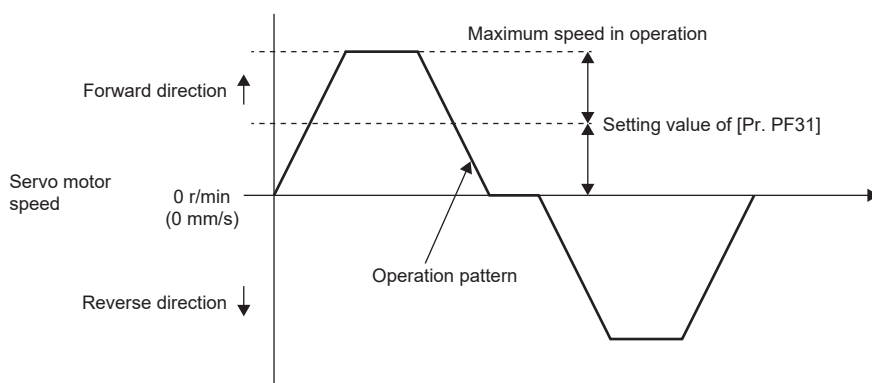

[Pr. PF32_Oscillation detection alarm time (*VIBT)]

Initial value	Setting range	Setting method	Ver.
50 [100 ms]	0 to 50	Each axis	A0

Set the time from when oscillation is detected until the occurrence of an alarm or warning.

When "0" is set, the time until the occurrence of the alarm or warning is 5000 ms.

When an oscillation detection alarm or warning is generated during normal operation, set a value larger than "10" (1000 ms).

[Pr. PF34_Machine diagnosis function selection (*MFP)]

Initial value	Setting range	Setting method	Ver.
00000000h	Refer to the relevant detail No.	Each axis	Refer to the relevant detail No.

[Pr. PF34.0_Friction failure prediction warning selection]

Initial value	Setting range	Ver.
0h	Refer to the text	A0

0: Disabled

1: Enabled (automatic threshold setting)

2: Enabled (manual threshold setting)

3: Threshold reset

When "2" is set, if the dynamic friction exceeds the set threshold, [AL. 0F7.2 Friction failure prediction warning] will occur.

When "3" is set, the setting of the servo parameter will change to "1" automatically after the threshold is reset.

[Pr. PF34.1_Vibration failure prediction warning selection]

Initial value	Setting range	Ver.
0h	Refer to the text	A0

0: Disabled

1: Enabled (automatic threshold setting)

2: Enabled (manual threshold setting)

3: Threshold reset

When "2" is set, if the vibration level exceeds the set threshold, [AL. 0F7.1 Vibration failure prediction warning] will occur.

When "3" is set, the setting of the servo parameter will change to "1" automatically after the threshold is reset.

[Pr. PF34.2_Servo motor total travel distance failure prediction warning selection]

Initial value	Setting range	Ver.
0h	Refer to the text	A0

0: Disabled

1: Enabled

2: Servo motor total travel distance reset

When "1" is set, if the value of the servo motor total travel distance + [Pr. PF47 Servo motor total travel distance offset] exceeds the value of [Pr. PF41 Failure prediction - Servo motor total travel distance], [AL. 0F7.3 Servo motor total travel distance failure prediction warning] will occur.

When "2" is set, the setting of the servo parameter will change to "1" automatically after the servo motor total travel distance reset.

[Pr. PF34.5_Static friction failure prediction warning selection]

Initial value	Setting range	Ver.
0h	Refer to the text	A0

0: Disabled

1: Automatic threshold setting

2: Manual threshold setting

3: Threshold reset

When "2" is set, if the static friction exceeds the set threshold, [AL. 0F7.5 Friction failure prediction warning] will occur.

When "3" is set, the setting of the servo parameter will change to "1" automatically after the threshold is reset.

[Pr. PF34.6_Friction estimate area judgment speed setting]

Initial value	Setting range	Ver.
0h	Refer to the text	A0

Select the setting method of "Machine diagnosis function - Friction estimate area judgment speed at low speed".

0: Manual setting

1: Automatic setting

When "1" (automatic setting) is set, [Pr. PF31 Machine diagnosis function - Friction estimate area judgment speed at low speed] will be calculated according to the servo motor operation pattern. After the calculation, [Pr. PF31] is rewritten to the calculation result, and the servo parameter will change to "0" (manual setting).

When "1" (automatic setting) is set, friction estimation stops.

[Pr. PF40_Machine failure prediction servo parameter (MFPP)]

Initial value	Setting range	Setting method	Ver.
0000000h	Refer to the relevant detail No.	Each axis	Refer to the relevant detail No.

[Pr. PF40.0_Friction failure prediction - Threshold multiplication]

Initial value	Setting range	Ver.
0h	0h to Fh	A0

Set a multiplying factor for calculating the threshold used in the friction failure prediction function.

The smaller the multiplying factor for the friction failure prediction threshold, the smaller the threshold used for friction failure prediction, which makes it easier to predict failure earlier, but also increases the possibility of erroneous detection.

When "0" is set, the threshold multiplying factor is 5.

[Pr. PF40.1_Vibration failure prediction - Threshold multiplication]

Initial value	Setting range	Ver.
0h	0h to Fh	A0

Set a multiplying factor for calculating the threshold used in the vibration failure prediction function.

The smaller the multiplying factor for the vibration failure prediction threshold, the smaller the threshold used for vibration failure prediction, which makes it easier to predict failure earlier, but also increases the possibility of erroneous detection.

When "0" is set, the threshold multiplying factor is 5.

[Pr. PF40.2_Friction failure prediction - Dynamic friction selection]

Initial value	Setting range	Ver.
0h	Refer to the text	A0

Select the dynamic friction to use for friction failure prediction.

0: Automatic setting

1: Dynamic friction at forward rotation torque (at rated speed)

2: Dynamic friction at reverse rotation torque (at rated speed)

3: Absolute value average at forward rotation/reverse rotation torque

When set to "0", the value changes to any of "1" to "3", depending on the operation pattern.

[Pr. PF40.4_Static friction failure prediction - Threshold multiplication]

Initial value	Setting range	Ver.
0h	0h to Fh	A0

Set a multiplying factor for calculating the threshold used in the static friction failure prediction function.

Setting a small threshold multiplication for static friction failure prediction will decrease the threshold used for static friction failure prediction. Thus, this will enable the prediction of a failure at an early stage, but will increase the possibility of erroneously detecting a failure.

When "0" is set, the threshold multiplying factor is 5.

[Pr. PF40.5_Static friction failure prediction - Static friction selection]

Initial value	Setting range	Ver.
0h	Refer to the text	A0

Select the static friction setting to use for static friction failure prediction.

0: Automatic setting

1: At forward rotation torque

2: At reverse rotation torque

3: Average at forward rotation/reverse rotation torque

When set to "0", the value changes to any of "1" to "3", depending on the operation pattern.

[Pr. PF41_Failure prediction - Servo motor total travel distance (FPMT)]

Initial value	Setting range	Setting method	Ver.
0 [10 rev], [m]	0 to 4294967295	Each axis	A0

Set a servo motor total travel distance required for determining the threshold used in the friction failure prediction function and the servo motor total travel distance failure prediction function.

When Servo motor total travel distance exceeds 1/2 of "Failure prediction - Servo motor total travel distance", the threshold will be automatically calculated for the friction failure prediction function.

When [Pr. PF34.2 Servo motor total travel distance failure prediction warning selection] is set to "1" (enabled), if the servo motor total travel distance + the value of [Pr. PF47 Servo motor total travel distance offset] exceeds the value of this servo parameter, [AL. 0F7.3 Servo motor total travel distance failure prediction warning] occurs.

[Pr. PF42_Friction failure prediction - Average characteristics (PAV)]

Initial value	Setting range	Setting method	Ver.
0 [0.1 %]	-10000 to 10000	Each axis	A0

Set the friction torque average value at the rated speed.

This servo parameter is enabled when [Pr. PF34.0 Friction failure prediction warning selection] is set to "2" (enabled (manual threshold setting)).

When [Pr. PF34.0 Friction failure prediction warning selection] is set to "1" (enabled (automatic threshold setting)), the value will be calculated automatically from the estimated friction torque at rated speed.

[Pr. PF43_Friction failure prediction - Standard deviation (PSD)]

Initial value	Setting range	Setting method	Ver.
0 [0.1 %]	0 to 20000	Each axis	A0

Set the friction torque standard deviation at the rated speed.

This servo parameter is enabled when [Pr. PF34.0 Friction failure prediction warning selection] is set to "2" (enabled (manual threshold setting)).

When [Pr. PF34.0 Friction failure prediction warning selection] is set to "1" (enabled (automatic threshold setting)), the value will be calculated automatically from the estimated friction torque at rated speed.

[Pr. PF45_Vibration failure prediction - Average characteristics (VAV)]

Initial value	Setting range	Setting method	Ver.
0 [0.1 %]	0 to 10000	Each axis	A0

Set a vibration level average during servo motor operation.

This servo parameter is enabled when [Pr. PF34.0 Friction failure prediction warning selection] is set to "2" (enabled (manual threshold setting)).

When [Pr. PF34.0 Friction failure prediction warning selection] is set to "1" (enabled (automatic threshold setting)), the value will be calculated automatically from the estimated friction torque at rated speed.

[Pr. PF46_Vibration failure prediction - Standard deviation (VSD)]

Initial value	Setting range	Setting method	Ver.
0 [0.1 %]	0 to 20000	Each axis	A0

Set the vibration level standard deviation during servo motor operation.

This servo parameter is enabled when [Pr. PF34.0 Friction failure prediction warning selection] is set to "2" (enabled (manual threshold setting)).

When [Pr. PF34.0 Friction failure prediction warning selection] is set to "1" (enabled (automatic threshold setting)), the value will be calculated automatically from the estimated friction torque at rated speed.

[Pr. PF47_Servo motor total travel distance offset (TMO)]

Initial value	Setting range	Setting method	Ver.
0 [10 rev], [m]	0 to 4294967295	Each axis	A0

Set an offset value for machine total travel distance.

After the equipment is replaced, set this servo parameter.

[Pr. PF62_Function selection F-14 (FOP14)]

Initial value	Setting range	Setting method	Ver.
00000000h	Refer to the relevant detail No.	Each axis	Refer to the relevant detail No.

[Pr. PF62.0_Backlash estimation unit selection]

Initial value	Setting range	Ver.
0h	Refer to the text	D0

Select the unit for "travel distance at backlash estimation" which is to be automatically set in the backlash estimation function.

0: Command pulse unit

1: Servo motor encoder pulse unit

A time-out will occur at execution of the backlash estimation function depending on the setting values for the electronic gear ([Pr. PA06 Electronic gear numerator]/[Pr. PA07 Electronic gear denominator]). When a time-out occurs, set this servo parameter to "1".

When this servo parameter is "0", the servo motor rotation amount is as follows.

Servo motor rotation amount = travel distance at backlash estimation × ([Pr. PA06]/[Pr. PA07]) [rev]

For "travel distance at backlash estimation", refer to "Gear failure diagnosis function" in the User's Manual (Function).

[Pr. PF63_Function selection F-15 (*FOP15)]

Initial value	Setting range	Setting method	Ver.
00000000h	Refer to the relevant detail No.	Each axis	Refer to the relevant detail No.

[Pr. PF63.0_[AL. 01A.5 Servo motor combination error 3] selection]

Initial value	Setting range	Ver.
0h	Refer to the text	D0

Select whether to enable or disable [AL. 01A.5 Servo motor combination error 3] for when a servo motor with a batteryless absolute position encoder is replaced.

0: Enabled

1: Disabled

With "1" (disabled) selected, connecting a servo motor that had not been connected at the startup of the absolute position detection system triggers [AL. 025.1 Servo motor encoder absolute position erased] instead of [AL. 01A.5 Servo motor combination error 3].

Connecting a servo motor other than the ones with a batteryless absolute position encoder triggers [AL. 01A.5].

[Pr. PF63.1_[AL. 01A.6 Servo motor combination error 4] selection]

Initial value	Setting range	Ver.
0h	Refer to the text	D0

Select whether to enable or disable [AL. 01A.6 Servo motor combination error 4] for when a servo motor with a batteryless absolute position encoder is replaced.

0: Enabled

1: Disabled

With "1" (disabled) selected, connecting a servo motor that had not been connected at the startup of the absolute position detection system triggers [AL. 025.2 Scale measurement encoder - Absolute position erased] instead of [AL. 01A.6 Servo motor combination error 4].

Connecting a servo motor other than the ones with a batteryless absolute position encoder triggers [AL. 01A.6].

This servo parameter is not available for the MR-J5-_G_-LL servo amplifier.

[Pr. PF66_Gear setting for backlash estimation (BLG)]

Initial value	Setting range	Setting method	Ver.
00000000h	Refer to the relevant detail No.	Each axis	Refer to the relevant detail No.

[Pr. PF66.0-3_Gear for backlash estimation - Numerator]

Initial value	Setting range	Ver.
0000h	0000h to FFFFh	A0

Set the gear ratio numerator of the gear connected to the servo motor in hexadecimal. If multiple gears are connected to the servo motor, set the gear ratio up to where the load is applied.

If the gear ratio numerator and the denominator cannot be expressed by numbers up to "2¹⁶-1", round up the gear ratio and set a value equal to or less than "2¹⁶-1" for both the numerator and the denominator.

[Pr. PF66.4-7_Gear for backlash estimation - Denominator]

Initial value	Setting range	Ver.
0000h	0000h to FFFFh	A0

Set the gear ratio denominator of the gear connected to the servo motor in hexadecimal. If multiple gears are connected to the servo motor, set the gear ratio up to where the load is applied.

If the gear ratio numerator and the denominator cannot be expressed by numbers up to "2¹⁶-1", round up the gear ratio and set a value equal to or less than "2¹⁶-1" for both the numerator and the denominator.

[Pr. PF67_Backlash nominal value (BLN)]

Initial value	Setting range	Setting method	Ver.
0 [0.01 degree]	0 to 3600000	Each axis	A0

To set the threshold for gear failure prediction, a backlash nominal value must be set. Input a backlash value presented by the manufacturer of the gear connected to the servo motor.

When [Pr. PF66.0-3 Gear for backlash estimation - Numerator] or [Pr. PF66.4-7 Gear for backlash estimation - Denominator] is set to "0", input the backlash nominal value after converting the value into the rotation angle on the servo motor side.

When [Pr. PF66.0-3] or [Pr. PF66.4-7] is set to a value other than "0", input a value considering the gear ratio for backlash estimation.

When the setting value of this servo parameter is "0", even if backlash estimation is performed, [AL. 0F7 Machine diagnosis warning] will not be generated.

[Pr. PF68_Backlash threshold multiplication (BLTT)]

Initial value	Setting range	Setting method	Ver.
0	0 to 3600000	Each axis	A0

Set the threshold multiplication that will be used for setting the threshold for gear failure prediction. The threshold used for the gear failure prediction is expressed by the following equation.

Backlash threshold = [Pr. PF67 Backlash nominal value]/100 × [Pr. PF68 Backlash threshold multiplication]/10

When the setting value of this servo parameter is "0", a value twice the value of [Pr. PF67 Backlash nominal value]/100 is set as the backlash threshold.

When the backlash threshold is "0", [AL. 0F7 Machine diagnosis warning] will not be generated even if the backlash estimation is performed.

[Pr. PF69_Static friction failure prediction - Average characteristics (SPAV2)]

Initial value	Setting range	Setting method	Ver.
0 [0.1 %]	0 to 10000	Each axis	A0

Set a static friction torque average.

This servo parameter is enabled when [Pr. PF34.5 Static friction failure prediction warning selection] is set to "2" (manual threshold setting).

When [Pr. PF34.5 Static friction failure prediction warning selection] is set to "1" (automatic threshold setting), the value will be calculated automatically from the estimated static friction torque.

[Pr. PF70_Static friction failure prediction - Standard deviation (SPSD2)]

Initial value	Setting range	Setting method	Ver.
0 [0.1 %]	0 to 20000	Each axis	A0

Set a standard deviation of static friction torque.

This servo parameter is enabled when [Pr. PF34.5 Static friction failure prediction warning selection] is set to "2" (manual threshold setting).

When [Pr. PF34.5 Static friction failure prediction warning selection] is set to "1" (automatic threshold setting), the value will be calculated automatically from the estimated friction torque at rated speed.

[Pr. PF71_Belt failure prediction function selection (BFP)]

Initial value	Setting range	Setting method	Ver.
00000000h	Refer to the relevant detail No.	Each axis	Refer to the relevant detail No.

[Pr. PF71.0_Belt tension deterioration prediction function selection]

Initial value	Setting range	Ver.
0h	Refer to the text	A0

0: Disabled

1: Execute only belt tension estimation

2: Belt tension deterioration prediction function enabled

After the equipment goes into full-scale operation, enable the belt tension deterioration prediction function.

[Pr. PF71.1_Belt tension deterioration prediction friction selection]

Initial value	Setting range	Ver.
0h	Refer to the text	A0

Select a static friction setting used for belt tension deterioration prediction.

0: Automatic setting

1: At forward rotation torque

2: At reverse rotation torque

3: Average at forward rotation/reverse rotation torque

When set to "0", the value changes to any of "1" to "3", depending on the operation pattern.

[Pr. PF72_Belt tension on installation (SBT)]

Initial value	Setting range	Setting method	Ver.
0 [0.1 N]	0 to 1000000	Each axis	A0

Set a belt tension for when the belt is attached to the equipment. The servo parameter indicates the reference belt tension threshold used in the belt diagnosis function.

[Pr. PF73_Belt tension when extended (ABT)]

Initial value	Setting range	Setting method	Ver.
0 [0.1 N]	0 to 1000000	Each axis	A0

After the equipment is operated, set a belt tension for when the belt stretches or for when the belt is looser than at the time of the attachment. After the belt has been attached to the equipment, the time taken for the belt to stretch depends on the belt type. For the time taken for the belt to stretch, refer to the catalog or other documents from the manufacturer.

The belt tension deterioration prediction function is disabled when the setting is: [Pr. PF72 Belt tension on installation] < [Pr. PF73 Belt tension when extended].

[Pr. PF74_Static friction during installation (SSF)]

Initial value	Setting range	Setting method	Ver.
0 [0.1 %]	0 to 10000	Each axis	A0

Set a static friction for when the belt is attached to the equipment. Set the static friction with any of the following values estimated by the friction estimation function depending on the value of [Pr. PF71.1 Belt tension deterioration prediction friction selection]: static friction at forward rotation, static friction at reverse rotation, or the average of the estimated frictions.

[Pr. PF75_Static friction when extended (ASF)]

Initial value	Setting range	Setting method	Ver.
0 [0.1 %]	0 to 10000	Each axis	A0

Set a static friction for when the belt stretches or for when the belt is looser than at the time of the attachment. Set the static friction with any of the following values estimated by the friction estimation function depending on the value of [Pr. PF71.1 Belt tension deterioration prediction friction selection]: static friction at forward rotation, static friction at reverse rotation, or the average of the estimated frictions.

The belt tension deterioration prediction function is disabled when the setting is: [Pr. PF74 Static friction during installation] < [Pr. PF75 Static friction when extended].

[Pr. PF76_Belt tension irregular threshold (BTS)]

Initial value	Setting range	Setting method	Ver.
0 [0.1 %]	0 to 1000	Each axis	A0

Set a threshold to generate [AL. 0F7 Machine diagnosis warning]. Set this servo parameter as a percentage of [Pr. PF72 Belt tension on installation]. When using the belt diagnosis function, input a value other than "0".

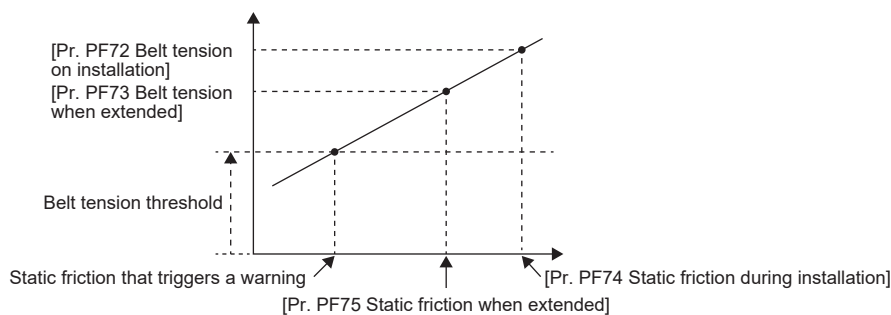

Belt tension threshold = [Pr. PF76 Belt tension irregular threshold]/100 × [Pr. PF72 Belt tension on installation]

[Pr. PF80_Drive recorder - Operation condition selection (DRMC)]

Initial value	Setting range	Setting method	Ver.
00000000h	Refer to the relevant detail No.	Each axis	Refer to the relevant detail No.

[Pr. PF80.0_Drive recorder - Operation mode selection]

Initial value	Setting range	Ver.
0h	Refer to the text	A0

0: Automatic setting mode

1: Manual setting mode

When "0" (automatic setting mode) is set, the setting values of [Pr. PF81 Drive recorder - Sampling operation selection] to [Pr. PF94 Drive recorder - Digital channel setting 4] are disabled. The drive recorder will be activated automatically at the same time as an alarm occurs.

When obtaining desired analog data from the drive recorder, set this servo parameter to "1" (manual setting mode) to set the trigger conditions and sampling cycle, and then start sampling with [Pr. PF81.0 Drive recorder - Sampling start selection].

To disable the drive recorder, set [Pr. PF21 Drive recorder switching time setting] to "-1" (drive recorder function disabled).

[Pr. PF80.2-3_Drive recorder - Sampling cycle selection]

Initial value	Setting range	Ver.
00h	Refer to the text	A0

Set the sampling cycle of the drive recorder.

When [Pr. PF80.0] is set to "0" (automatic setting mode), the setting value of this servo parameter is disabled.

Setting value	8 kHz class
00	Automatic (250 μ s)
05	250 μ s
06	500 μ s
07	1 ms
08	2 ms
09	4 ms
0A	8 ms
0B	16 ms
0C	32 ms
0D	64 ms
0E	128 ms
0F	256 ms
10	512 ms
11	1.024 s

[Pr. PF81_Drive recorder - Sampling operation selection (DRMS)]

Initial value	Setting range	Setting method	Ver.
00000000h	Refer to the relevant detail No.	Each axis	Refer to the relevant detail No.

[Pr. PF81.0_Drive recorder - Sampling start selection]

Initial value	Setting range	Ver.
0h	Refer to the text	A0

Set this servo parameter to start drive recorder sampling.

When [Pr. PF80.0 Drive recorder - Operation mode selection] is set to "0" (automatic setting mode), the setting value of the servo parameter is disabled.

When this servo parameter is set to "1" or "2", if the settings of [Pr. PF80.2-3 Drive recorder - Sampling cycle selection] and [Pr. PF82 Drive recorder - Trigger operation selection] to [Pr. PF94 Drive recorder - Digital channel setting 4] are changed, the changed settings are not applied to the drive recorder. To apply the settings, cycle the power, reset the software, or set this servo parameter to "0" (stop sampling), then set "1" or "2" again.

The storage area of the servo amplifier has a limit for the number of writings. If the trigger conditions that have been set in [Pr. PF82] are frequently met, do not continue using this servo parameter when it is set to "2" (continuous sampling).

0: Stop sampling

1: Start a single sampling

2: Start a consecutive sampling

When "1" (start a single sampling) is set, if the trigger conditions are fulfilled after sampling starts, the drive recorder will operate to save data once. After the data has been saved, this servo parameter will be "0" automatically.

When "2" (start a consecutive sampling) is set, if the trigger conditions are fulfilled after sampling starts, the drive recorder will operate to save data. After that, sampling will start again.

[Pr. PF82_Drive recorder - Trigger operation selection (DRTM)]

Initial value	Setting range	Setting method	Ver.
00000000h	Refer to the relevant detail No.	Each axis	Refer to the relevant detail No.

[Pr. PF82.0_Drive recorder - Trigger mode selection]

Initial value	Setting range	Ver.
0h	Refer to the text	A0

Select the trigger mode for the drive recorder.

When [Pr. PF80.0 Drive recorder - Operation mode selection] is set to "0" (automatic setting mode), the setting value of the servo parameter is disabled.

0: Alarm trigger

1: Analog trigger/digital trigger

When "0" (alarm trigger) is set, trigger settings other than [Pr. PA23 Drive recorder desired alarm trigger setting] and [Pr. PF84.4-5 Drive recorder - Trigger position setting] are disabled. Refer to the following table for the unavailable servo parameters.

Servo parameter	Name
PF82.1	Drive recorder - Trigger binding mode selection
PF82.2	Drive recorder - Trigger operation selection 1
PF82.3	Drive recorder - Trigger operation selection 2
PF84.0-1	Drive recorder - Trigger channel selection 1
PF84.2-3	Drive recorder - Trigger channel selection 2
PF85	Drive recorder - Trigger level setting 1
PF86	Drive recorder - Trigger level setting 2

[Pr. PF82.1_Drive recorder - Trigger binding condition selection]

Initial value	Setting range	Ver.
0h	Refer to the text	A0

Select the trigger binding condition for the drive recorder.

When this servo parameter is set to "0" (disabled), the settings of [PF84.2-3 Drive recorder - Trigger channel selection 2] and [PF86 Drive recorder - Trigger level setting 2] are disabled.

When [Pr. PF80.0 Drive recorder - Operation mode selection] is set to "0" (automatic setting mode), or [Pr. PF80.0] is set to "1" and [Pr. PF82.0 Drive recorder - Trigger mode selection] is set to "0" (alarm trigger), the setting value of this servo parameter is disabled.

0: Disabled

1: Logical AND of trigger signals

2: Logical OR of trigger signals

[Pr. PF82.2_Drive recorder - Trigger operation selection 1]

Initial value	Setting range	Ver.
0h	Refer to the text	A0

Select whether sampling starts when the signal output for the drive recorder channel set in [Pr. PF84.0-1 Drive recorder - Trigger channel selection 1] exceeds or falls below the set trigger level.

When [Pr. PF80.0 Drive recorder - Operation mode selection] is set to "0" (automatic setting mode), or [Pr. PF80.0] is set to "1" and [Pr. PF82.0] is set to "0", the setting value of this servo parameter is disabled.

0: Rising

1: Falling

[Pr. PF82.3_Drive recorder - Trigger operation selection 2]

Initial value	Setting range	Ver.
0h	Refer to the text	A0

Select whether sampling starts when the signal output for the drive recorder channel set in [Pr. PF84.2-3 Drive recorder - Trigger channel selection 2] exceeds or falls below the set trigger level.

The servo parameter is disabled in the following conditions.

- [Pr. PF80.0 Drive recorder - Operation mode selection] is set to "0" (automatic setting mode)
- [Pr. PF82.0 Drive recorder - Trigger mode selection] is set to "0" (alarm trigger)
- [Pr. PF82.1 Drive recorder - Trigger binding condition selection] is set to "0" (disabled)

0: Rising

1: Falling

[Pr. PF83_Drive recorder - Trigger operation axis common selection (**DRTAX)]

Initial value	Setting range	Setting method	Ver.
00000000h	Refer to the relevant detail No.	Common	Refer to the relevant detail No.

[Pr. PF83.0_Drive recorder - Trigger axis common selection]

Initial value	Setting range	Ver.
0h	Refer to the text	A0

For when the trigger conditions of the drive recorder are met on a multi-axis servo amplifier, select whether to store only the data of the axis in which the conditions are met, or to store the data of all axis.

0: Disabled

1: Enabled

When "0" (disabled) is set, the drive recorder data is stored on the axis in which the trigger conditions are met.

If "1" (enabled) is set, the trigger conditions will be regarded as having been met on all axes even if the trigger conditions have only been met on Axis A, B, or C. The trigger conditions are not regarded as having been met on axes for which "0" (automatic setting mode) is set in [Pr. PF80.0 Drive recorder - Operation mode selection].

The servo parameter is disabled in the following conditions.

- The MR-J5-_G_ or MR-J5D1-_G_ is used,
- The axis of a multi-axis servo amplifier which has [Pr. PF80.0] set to "0" (automatic setting)" is used,
- The axis of a multi-axis servo amplifier which has [Pr. PF80.0] set to "1" (manual setting mode) and [Pr. PF82.0] set to "0" (alarm trigger) is used.

[Pr. PF84_Drive recorder - Trigger channel selection (DRTC)]

Initial value	Setting range	Setting method	Ver.
005A8101h	Refer to the relevant detail No.	Each axis	Refer to the relevant detail No.

[Pr. PF84.0-1_Drive recorder - Trigger channel selection 1]

Initial value	Setting range	Ver.
01h	Refer to the text	A0

Set the trigger channel No. 1 of the drive recorder.

The servo parameter is disabled in the following conditions.

- [Pr. PF80.0 Drive recorder - Operation mode selection] is set to "0" (automatic setting mode)
- [Pr. PF82.0 Drive recorder - Trigger mode selection] is set to "0" (alarm trigger)

Setting value	Meaning
01	Analog channel 1
02	Analog channel 2
03	Analog channel 3
04	Analog channel 4
05	Analog channel 5
06	Analog channel 6
07	Analog channel 7
81	Digital channel 1
82	Digital channel 2
83	Digital channel 3
84	Digital channel 4
85	Digital channel 5
86	Digital channel 6
87	Digital channel 7
88	Digital channel 8

[Pr. PF84.2-3_Drive recorder - Trigger channel selection 2]

Initial value	Setting range	Ver.
81h	Refer to the text	A0

Set the trigger channel No. 2 of the drive recorder. The setting value is the same as that of [Pr. PF84.0-1].

The servo parameter is disabled in the following conditions.

- [Pr. PF80.0 Drive recorder - Operation mode selection] is set to "0" (automatic setting mode)
- [Pr. PF82.0 Drive recorder - Trigger mode selection] is set to "0" (alarm trigger)
- [Pr. PF82.1 Drive recorder - Trigger binding condition selection] is set to "0" (disabled)

[Pr. PF84.4-5_Drive recorder - Trigger position setting]

Initial value	Setting range	Ver.
5Ah	00h to 6Fh	A0

Convert trigger position 1 (0 % to 100 % of the total sampling time of the drive recorder) to a hexadecimal value, and set the value. When trigger position 1 exceeds 100 %, the value will be clamped to 100 %.

For example, to set the trigger position to 30 %, set "1Eh" in this servo parameter.

[Pr. PF85_Drive recorder - Trigger level setting 1 (DRTL1)]

Initial value	Setting range	Setting method	Ver.
0	-2147483648 to 2147483647	Each axis	A0

Set the trigger level of trigger channel No. 1 of the drive recorder in decimal.

Set the value considering the decimal point.

For example, if setting a torque of 100.0 [%] for the trigger level, set this servo parameter to "1000" because the torque unit is [0.1 %].

The servo parameter is disabled in the following conditions.

- [Pr. PF80.0 Drive recorder - Operation mode selection] is set to "0" (automatic setting mode)
- [Pr. PF80.0] is set to "1" (manual setting mode) and [Pr. PF82.0 Drive recorder - Trigger mode selection] is set to "0" (alarm trigger)
- A digital channel is set in the first trigger of [Pr. PF84.0-1 Drive recorder - Trigger channel selection 1]

[Pr. PF86_Drive recorder - Trigger level setting 2 (DRTL2)]

Initial value	Setting range	Setting method	Ver.
0	-2147483648 to 2147483647	Each axis	A0

Set the trigger level of trigger channel No. 2 of the drive recorder in decimal.

Set the value considering the decimal point.

For example, if setting a torque of 100.0 [%] for the trigger level, set this servo parameter to "1000" because the torque unit is [0.1 %].

The servo parameter is disabled in the following conditions.

- [Pr. PF80.0 Drive recorder - Operation mode selection] is set to "0" (automatic setting mode)
- [Pr. PF80.0] is set to "1" (manual setting mode) and [Pr. PF82.0 Drive recorder - Trigger mode selection] is set to "0" (alarm trigger)
- [Pr. PF82.1 Drive recorder - Trigger binding condition selection] is set to "0" (disabled)
- A digital channel is set in the second trigger of [Pr. PF84.2-3 Drive recorder - Trigger channel selection 2]

[Pr. PF87_Drive recorder - Analog channel setting 1 (DRAC1)]

Initial value	Setting range	Setting method	Ver.
00020201h	Refer to the relevant detail No.	Each axis	Refer to the relevant detail No.

[Pr. PF87.0-2_Drive recorder - Analog channel 1 selection]

Initial value	Setting range	Ver.
201h	Refer to the text	A0

Select the data to be assigned to analog channel 1 of the drive recorder.

The servo parameter is disabled in the following conditions.

- [Pr. PF80.0 Drive recorder - Operation mode selection] = "0" (automatic setting mode)

Refer to the following table for setting values.

Values not listed below are undefined. Only set the values that are listed in the following table.

Setting value	Data type	Unit *1	Category
000	No assigned function	—	—
001	Servo motor speed	r/min	16-bit data
002	Torque/instantaneous torque	0.1 %	
003	Current command	0.1 %	
005	Command pulse frequency (speed unit)	r/min	
007	Droop pulses (1 pulse unit)	pulse	
008	Speed command	r/min	
009	Bus voltage	V	
00A *6	Pressure command	LSB	
00B *6	Pressure feedback	LSB	
00C	Effective load ratio	0.1 %	
00D	Regenerative load ratio	0.1 %	
00E	Position within one-revolution	16 pulse	
00F	ABS counter	rev	
010	Load to motor inertia ratio	0.01 times	
011	Torque equivalent to disturbance	0.1 %	
012	Overload alarm margin	0.1 %	
014	Settling time	ms	
015	Overshoot amount	pulse	
016 *6	Analog monitor input 1	LSB	
017 *6	Analog monitor input 2	LSB	
01C *2	Load-side encoder droop pulses (1 pulse unit)	pulse	
01E *2	Motor-side/load-side position deviation (1 pulse unit)	pulse	
020 *2	Motor-side/load-side speed deviation	r/min	
021	Servo motor speed (unit of 0.1 r/min)	0.1 r/min	
022	Command pulse frequency (speed unit of 0.1 r/min)	0.1 r/min	
023	Speed command (unit of 0.1 r/min)	0.1 r/min	
024	Torque command	0.1 %	
025	Speed limit value	r/min	
026	Speed limit value (unit of 0.1 r/min)	0.1 r/min	
035	Internal temperature of encoder	°C	
03B	Load-side encoder information 1	16 pulse	
03C	Load-side encoder information 2	rev	
03D *4	Command number	LSB	
049	Operation mode	LSB	
04C *3	U-phase current feedback (unit of the rated current)	0.1 %	
04D *3	V-phase current feedback (unit of the rated current)	0.1 %	
04E *3	W-phase current feedback (unit of the rated current)	0.1 %	

Setting value	Data type	Unit *1	Category
201	Servo motor speed +	0.1 r/min	32-bit data
202	Command pulse frequency +	kpulse/s	
203	Command pulse frequency (speed unit) +	0.1 r/min	
204	Droop pulses (1 pulse unit) +	pulse	
205	Speed command +	0.1 r/min	
206	Position within one-revolution +	pulse	
207	Load-side encoder information 1 +	pulse	
208	Load-side encoder information 2 +	rev	
209	Load-side droop pulses +	pulse	
20A *5	Controller position command +	pulse	
20B	Feedback position +	pulse	
20C	Excessive error alarm margin +	pulse	
20D *4	Current position (positioning unit) +	pos units	
20E *4	Command position (positioning unit) +	pos units	
20F *4	Command remaining distance (positioning unit) +	pos units	
218	Droop pulses (100 pulse unit) +	100 pulse	
219 *2	Load-side encoder droop pulses (100 pulses unit) +	100 pulse	
21A	Excessive error alarm margin (100 pulses unit) +	100 pulse	
21B	Droop pulses (model position deviation) +	pulse	
21F *5	Motor-side/load-side position deviation (100 pulse unit) +	100 pulse	
220	Speed command 2 +	0.1 r/min	
23C	Droop pulses (command unit) +	pulse	

*1 "mm/s" is used instead of "r/min" for linear servo motors.

*2 Available on servo amplifiers with firmware version A5 or later.

*3 Available on servo amplifiers with firmware version B0 or later.

*4 Available on servo amplifiers with firmware version B8 or later.

*5 Available on servo amplifiers with firmware version D4 or later.

*6 Available only on the MR-J5-_G_-LL servo amplifier.

[Pr. PF87.4-6_Drive recorder - Analog channel 2 selection]

Initial value	Setting range	Ver.
002h	Refer to the text	A0

Select the analog channel 2 of the drive recorder.

The servo parameter is disabled in the following conditions.

- [Pr. PF80.0 Drive recorder - Operation mode selection] is set to "0" (automatic setting mode)

Refer to the following for values that can be assigned.

 Page 151 [Pr. PF87.0-2_Drive recorder - Analog channel 1 selection]

[Pr. PF88_Drive recorder - Analog channel setting 2 (DRAC2)]

Initial value	Setting range	Setting method	Ver.
02040003h	Refer to the relevant detail No.	Each axis	Refer to the relevant detail No.

[Pr. PF88.0-2_Drive recorder - Analog channel 3 selection]

Initial value	Setting range	Ver.
003h	Refer to the text	A0

Select the analog channel 3 of the drive recorder.

The servo parameter is disabled in the following conditions.

- [Pr. PF80.0 Drive recorder - Operation mode selection] is set to "0" (automatic setting mode)

Refer to the following for values that can be assigned.

 Page 151 [Pr. PF87.0-2_Drive recorder - Analog channel 1 selection]

[Pr. PF88.4-6_Drive recorder - Analog channel 4 selection]

Initial value	Setting range	Ver.
204h	Refer to the text	A0

Select the analog channel 4 of the drive recorder.

The servo parameter is disabled in the following conditions.

- [Pr. PF80.0 Drive recorder - Operation mode selection] is set to "0" (automatic setting mode)

Refer to the following for values that can be assigned.

 Page 151 [Pr. PF87.0-2_Drive recorder - Analog channel 1 selection]

[Pr. PF89_Drive recorder - Analog channel setting 3 (DRAC3)]

Initial value	Setting range	Setting method	Ver.
00090205h	Refer to the relevant detail No.	Each axis	Refer to the relevant detail No.

[Pr. PF89.0-2_Drive recorder - Analog channel 5 selection]

Initial value	Setting range	Ver.
205h	Refer to the text	A0

Select the analog channel 5 of the drive recorder.

The servo parameter is disabled in the following conditions.

- [Pr. PF80.0 Drive recorder - Operation mode selection] is set to "0" (automatic setting mode)

Refer to the following for values that can be assigned.

 Page 151 [Pr. PF87.0-2_Drive recorder - Analog channel 1 selection]

[Pr. PF89.4-6_Drive recorder - Analog channel 6 selection]

Initial value	Setting range	Ver.
009h	Refer to the text	A0

Select the analog channel 6 of the drive recorder.

The servo parameter is disabled in the following conditions.

- [Pr. PF80.0 Drive recorder - Operation mode selection] is set to "0" (automatic setting mode)

Refer to the following for values that can be assigned.

 Page 151 [Pr. PF87.0-2_Drive recorder - Analog channel 1 selection]

[Pr. PF90_Drive recorder - Analog channel setting 4 (DRAC4)]

Initial value	Setting range	Setting method	Ver.
0000000Ch	Refer to the relevant detail No.	Each axis	Refer to the relevant detail No.

[Pr. PF90.0-2_Drive recorder - Analog channel 7 selection]

Initial value	Setting range	Ver.
00Ch	Refer to the text	A0

Select the analog channel 7 of the drive recorder.

The servo parameter is disabled in the following conditions.

- [Pr. PF80.0 Drive recorder - Operation mode selection] is set to "0" (automatic setting mode)

Refer to the following for values that can be assigned.

 Page 151 [Pr. PF87.0-2_Drive recorder - Analog channel 1 selection]

[Pr. PF91_Drive recorder - Digital channel setting 1 (DRDC1)]

Initial value	Setting range	Setting method	Ver.
0012000h	Refer to the relevant detail No.	Each axis	Refer to the relevant detail No.

[Pr. PF91.0-3_Drive recorder - Digital channel 1 selection]

Initial value	Setting range	Ver.
0000h	Refer to the text	A0

Refer to the following table for setting values.

Values not listed below are undefined. Only set the values that are listed in the following table.

Setting value	Symbol	Name	Classification
0000	CSON	Servo-on command	DI
0001	LSP	Forward rotation stroke end	
0002	LSN	Reverse rotation stroke end	
0005	PC	Proportional control	
0006	RES	Reset	
0012	EM2/1	Forced stop	
0013	CRDY	Ready-on command	
0016	STO1	STO1	
0017	STO2	STO2	
001A	CDP2	Gain switching selection 2	
001B	CDP	Gain switching selection	
001C *1	CLD	Fully closed loop selection	
0034 *1	TPR1	Touch probe 1	
0035 *1	TPR2	Touch probe 2	
0036 *1	TPR3	Touch probe 3	
0049	CFLS	Controller upper stroke limit signal being input	
004A	CRLS	Controller lower stroke limit signal being input	
00A0 *2	STOC	STO command	
00A1 *2	SS1C	SS1 command	
00A2 *2	SS2C	SS2 command	
00A3 *2	SLS1C	SLS1 command	
00A4 *2	SLS2C	SLS2 command	
00A5 *2	SLS3C	SLS3 command	
00A6 *2	SLS4C	SLS4 command	
00A7 *2	SDIPC	SDIP command	
00A8 *2	SDINC	SDIN command	
00A9 *2	SLT1C	SLT1 command	
00AA *2	SLT2C	SLT2 command	
00AB *2	SLT3C	SLT3 command	
00AC *2	SLT4C	SLT4 command	
00AD *2	SLIC	SLI command	

Setting value	Symbol	Name	Classification
8000	RD	Ready	DO
8001	SA	Speed reached	
8002	ZSP	Zero speed detection	
8003	TLC	Limiting torque	
8004	VLC	Limiting speed	
8005	INP	In-position completion	
8007	WNG	Warning	
8008	ALM	Malfunction	
8009	OP	Z-phase output	
800A	MBR	Electromagnetic brake interlock	
800B	DB	External dynamic brake	
800F	BWNG	Battery warning	
8010	ALM2	Malfunction 2	
8013	RDY	In ready-on state	
8015	STO	In STO state	
8016	SMPD	Magnetic pole detection completion	
8017	ZPASS	Z-phase already passed	
8018	CDPS2	Variable gain enabled 2	
8019	CDPS	Variable gain enabled	
801A *1	CLDS	Fully closed loop control in progress	
801B	ABSV	Absolute position erased	
801D	IPF	Instantaneous power failure	
801E	SPC	Proportional control in progress	
801F	MTTR	Tough drive in progress	
8032	DOG	DOG signal input in progress	
803C *3	DOA	General-purpose output A	
803D *3	DOB	General-purpose output B	
803E *3	DOC	General-purpose output C	
8043 *1	CPO	Rough match	
8045 *1	POT	Position range	
8047 *4	MEND	Traveling completion	
8049	ZP2	Homing completion 2	
804B *5	CVST	Converter stop	
8056	INP2	CiA 402 Target position reached	
8074 *6	ATM	Pressure model under control	
8077 *6	ATLC	Pressure command limited	
80A0 *2	STOS	STO output	
80A1 *2	SS1S	SS1 output	
80A2 *2	SS2S	SS2 output	
80A3 *2	SLS1S	SLS1 output	
80A4 *2	SLS2S	SLS2 output	
80A5 *2	SLS3S	SLS3 output	
80A6 *2	SLS4S	SLS4 output	
80A7 *2	SSMS	SSM output	
80A8 *2	SOSS	SOS output	
80A9 *2	SBCS	SBC output	
80AA *2	SDIPS	SDIP output	
80AB *2	SDINS	SDIN output	
80AC *2	SLT1S	SLT1 output	
80AD *2	SLT2S	SLT2 output	
80AE *2	SLT3S	SLT3 output	
80AF *2	SLT4S	SLT4 output	
80B1 *2	SLIS	SLI output	

- *1 Available on servo amplifiers with firmware version A5 or later.
- *2 Available on servo amplifiers with firmware version B2 or later.
- *3 Available on servo amplifiers with firmware version B6 or later.
- *4 Available on servo amplifiers with firmware version B8 or later.
- *5 Available only on the MR-J5D_-_G_.
- *6 Available only on the MR-J5-_G_-LL servo amplifier.

[Pr. PF91.4-7_Drive recorder - Digital channel 2 selection]

Initial value	Setting range	Ver.
0012h	Refer to the text	A0

Refer to the following for values that can be assigned.

 Page 154 [Pr. PF91.0-3_Drive recorder - Digital channel 1 selection]

[Pr. PF92_Drive recorder - Digital channel setting 2 (DRDC2)]

Initial value	Setting range	Setting method	Ver.
80058010h	Refer to the relevant detail No.	Each axis	Refer to the relevant detail No.

[Pr. PF92.0-3_Drive recorder - Digital channel 3 selection]

Initial value	Setting range	Ver.
8010h	Refer to the text	A0

Refer to the following for values that can be assigned.

☞ Page 154 [Pr. PF91.0-3_Drive recorder - Digital channel 1 selection]

[Pr. PF92.4-7_Drive recorder - Digital channel 4 selection]

Initial value	Setting range	Ver.
8005h	Refer to the text	A0

Refer to the following for values that can be assigned.

☞ Page 154 [Pr. PF91.0-3_Drive recorder - Digital channel 1 selection]

[Pr. PF93_Drive recorder - Digital channel setting 3 (DRDC3)]

Initial value	Setting range	Setting method	Ver.
8000800Ah	Refer to the relevant detail No.	Each axis	Refer to the relevant detail No.

[Pr. PF93.0-3_Drive recorder - Digital channel 5 selection]

Initial value	Setting range	Ver.
800Ah	Refer to the text	A0

Refer to the following for values that can be assigned.

☞ Page 154 [Pr. PF91.0-3_Drive recorder - Digital channel 1 selection]

[Pr. PF93.4-7_Drive recorder - Digital channel 6 selection]

Initial value	Setting range	Ver.
8000h	Refer to the text	A0

Refer to the following for values that can be assigned.

☞ Page 154 [Pr. PF91.0-3_Drive recorder - Digital channel 1 selection]

[Pr. PF94_Drive recorder - Digital channel setting 4 (DRDC4)]

Initial value	Setting range	Setting method	Ver.
801D8015h	Refer to the relevant detail No.	Each axis	Refer to the relevant detail No.

[Pr. PF94.0-3_Drive recorder - Digital channel 7 selection]

Initial value	Setting range	Ver.
8015h	Refer to the text	A0

Refer to the following for values that can be assigned.

☞ Page 154 [Pr. PF91.0-3_Drive recorder - Digital channel 1 selection]

[Pr. PF94.4-7_Drive recorder - Digital channel 8 selection]

Initial value	Setting range	Ver.
801Dh	Refer to the text	A0

Refer to the following for values that can be assigned.

☞ Page 154 [Pr. PF91.0-3_Drive recorder - Digital channel 1 selection]

[Pr. PF95_Drive recorder - Clear history (**DRCLR)]

Initial value	Setting range	Setting method	Ver.
00000000h	Refer to the relevant detail No.	Each axis	Refer to the relevant detail No.

[Pr. PF95.0_Drive recorder - Clear history selection]

Initial value	Setting range	Ver.
0h	Refer to the text	A0

0: Disabled

1: Enabled

When "0" (enabled) is set, the drive recorder history will be cleared at the next power-on or software reset. After the drive recorder history is cleared, "0" (disabled) will be set to this servo parameter automatically.

1.8 Motor extension setting servo parameters group ([Pr. PL_ _])

[Pr. PL01_Function selection L-1 (**LIT1)]

Initial value	Setting range	Setting method	Ver.
00000301h	Refer to the relevant detail No.	Each axis	Refer to the relevant detail No.

Select a function of the linear servo motor or direct drive motor.

[Pr. PL01.0_Servo motor magnetic pole detection selection]

Initial value	Setting range	Ver.
1h	Refer to the text	A0

Select the magnetic pole detection method for the linear servo motor or direct drive motor.

0: Magnetic pole detection disabled

1: Magnetic pole detection at initial servo-on after cycling the power or after resetting the communication

5: Magnetic pole detection at every servo-on

The setting value "0" can be used on servo amplifiers with firmware version D0 or later when the fully closed loop system is used with a Mitsubishi Electric-manufactured direct drive motor connected by the direct drive motor control mode.

Do not set any value other than "0", "1", and "5".

[Pr. PL01.2_Homing stop interval setting]

Initial value	Setting range	Ver.
3h	Refer to the text	A0

Select the stop interval at dog type homing.

This servo parameter is enabled only for linear servo motors.

0: 2^{13} (= 8192) pulses

1: 2^{17} (= 131072) pulses

2: 2^{18} (= 262144) pulses

3: 2^{20} (= 1048576) pulses

4: 2^{22} (= 4194304) pulses

5: 2^{24} (= 16777216) pulses

6: 2^{26} (= 67108864) pulses

[Pr. PL02_Linear encoder resolution setting - Numerator (**LIM)]

Initial value	Setting range	Setting method	Ver.
1000 [μm]	1 to 65535	Each axis	A0

Set the linear encoder resolution with [Pr. PL02] and [Pr. PL03].

Set a numerator in [Pr. PL02].

This servo parameter is enabled for linear servo motors.

[Pr. PL03_Linear encoder resolution setting - Denominator (**LID)]

Initial value	Setting range	Setting method	Ver.
1000 [μm]	1 to 65535	Each axis	A0

Set the linear encoder resolution with [Pr. PL02] and [Pr. PL03].

Set a denominator in [Pr. PL03].

This servo parameter is enabled for linear servo motors.

[Pr. PL04_Function selection L-2 (*LIT2)]

Initial value	Setting range	Setting method	Ver.
00000003h	Refer to the relevant detail No.	Each axis	Refer to the relevant detail No.

Select a function of the linear servo motor or direct drive motor.

[Pr. PL04.0_[AL. 042 Servo control error] detection function selection]

Initial value	Setting range	Ver.
3h	Refer to the text	A0

Refer to the following table for setting values.

Setting value	Thrust/torque deviation error	Speed deviation error	Position deviation error
0	Disabled	Disabled	Disabled
1			Enabled
2		Enabled	Disabled
3			Enabled
4	Enabled	Disabled	Disabled
5			Enabled
6		Enabled	Disabled
7			Enabled

[Pr. PL04.3_[AL. 042 Servo control error] detection controller reset condition selection]

Initial value	Setting range	Ver.
0h	Refer to the text	A0

0: Reset disabled (reset by powering off/on or software reset enabled)

1: Reset enabled

[Pr. PL05_Position deviation error detection level (LB1)]

Initial value	Setting range	Setting method	Ver.
0 [mm], [0.01 rev]	0 to 1000	Each axis	A0

Set a position deviation error detection level of the servo control error detection.

When the difference between a model feedback position and actual feedback position is larger than the setting value, [AL. 042.1 Servo control error based on position deviation] will occur.

Note that when "0" is set, the level varies depending on the setting value in [PA01.1 Operation mode selection].

When a linear servo motor is used: 50 mm

When a direct drive motor is used: 0.09 rev

[Pr. PL06_Speed deviation error detection level (LB2)]

Initial value	Setting range	Setting method	Ver.
0 [mm/s], [r/min]	0 to 20000	Each axis	A0

Set the speed deviation error detection level of the servo control error detection.

When the difference between a model feedback speed and actual feedback speed is larger than the setting value, [AL. 042.2 Servo control error based on speed deviation] will occur.

Note that when "0" is set, the level varies depending on the setting value in [PA01.1 Operation mode selection].

When a linear servo motor is used: 1000 mm/s

When a direct drive motor is used: 100 r/min

[Pr. PL07_Torque deviation error detection level (LB3)]

Initial value	Setting range	Setting method	Ver.
100 [%]	0 to 1000	Each axis	A0

Set the torque/thrust deviation error detection level of the servo control error detection.

When the difference between a current command and current feedback is larger than the setting value, [AL. 042.3 Servo control error by torque/thrust deviation] occurs.

[Pr. PL08_Function selection L-3 (*LIT3)]

Initial value	Setting range	Setting method	Ver.
00001010h	Refer to the relevant detail No.	Each axis	Refer to the relevant detail No.

Select a function of the linear servo motor or direct drive motor.

[Pr. PL08.0_Magnetic pole detection method selection]

Initial value	Setting range	Ver.
0h	Refer to the text	A0

0: Position detection method

4: Minute position detection method

If detecting magnetic poles in a vertical axis, configure a system with equipment such as a counterweight to prevent the linear servo motor from moving with the force of gravity.

[Pr. PL08.2_Magnetic pole detection - Stroke limit enabled/disabled selection]

Initial value	Setting range	Ver.
0h	Refer to the text	A0

0: Enabled

1: Disabled

[Pr. PL09_Magnetic pole detection voltage level (LPWM)]

Initial value	Setting range	Setting method	Ver.
30 [%]	0 to 100	Each axis	A0

Set a direct current exciting voltage level in the magnetic pole detection.

If [AL. 032 Overcurrent], [AL. 050 Overload 1], or [AL. 051 Overload 2] occurs during the magnetic pole detection, set a smaller value.

If [AL. 027 Initial magnetic pole detection error] occurs during the magnetic pole detection, set a larger value.

[Pr. PL17_Magnetic pole detection - Minute position detection method - Function selection (LTSTS)]

Initial value	Setting range	Setting method	Ver.
00000000h	Refer to the relevant detail No.	Each axis	Refer to the relevant detail No.

This servo parameter is enabled when [Pr. PL08.0 Magnetic pole detection method selection] is set to "4" (minute position detection method).

[Pr. PL17.0_Response selection]

Initial value	Setting range	Ver.
0h	Refer to the text	A0

Select the responsiveness of the minute position detection method.

To make the travel distance at the magnetic pole detection smaller, set a larger value.

Refer to the following table for setting values.

Setting value of [Pr. PL17.0]	Responsiveness
0	
1	
2	
3	
4	
5	
6	
7	
8	
9	
A	
B	
C	
D	
E	
F	

[Pr. PL17.1_Load to motor mass ratio/load to motor inertia ratio selection]

Initial value	Setting range	Ver.
0h	Refer to the text	A0

Select a load to mass of the linear servo motor primary-side ratio or load to mass of the direct drive motor inertia ratio used for the minute position detection method. Select a value closest to the actual load.

Refer to the following table for setting values.

Setting value of [Pr. PL17.1]	Load to motor mass ratio/load to motor inertia ratio
0	10 times or less
1	10 times
2	20 times
3	30 times
4	40 times
5	50 times
6	60 times
7	70 times
8	80 times
9	90 times
A	100 times
B	110 times
C	120 times
D	130 times
E	140 times
F	150 times or more

[Pr. PL18_Magnetic pole detection - Minute position detection method - Identification signal amplitude (IDLV)]

Initial value	Setting range	Setting method	Ver.
0 [%]	0 to 200	Each axis	A0

Set an identification signal amplitude to be used in the minute position detection method.

This servo parameter is enabled when [Pr. PL08.0 Magnetic pole detection method selection] is set to "4".

When the setting value of this servo parameter is set to "0", the amplitude will be 100 [%].

1.9 Positioning control setting servo parameters group ([Pr. PT_ _])

[Pr. PT01_Command mode selection (**CTY)]

Initial value		Setting range	Setting method	Ver.
J5G	J5G-N1			
00000300h	00000310h	Refer to the relevant detail No.	Each axis	Refer to the relevant detail No.

[Pr. PT01.1_Speed/acceleration/deceleration unit selection]

Initial value		Setting range	Ver.
J5G	J5G-N1		
0h	1h	Refer to the text	A5

Select the unit of speed and the unit of acceleration/deceleration.

This function is enabled in the cyclic synchronous mode, profile mode, positioning mode (point table method), and slave axis torque mode.

Setting value	Speed	Acceleration/deceleration
0	r/min, mm/s *1	ms
1	Command unit/s *2	Command unit/s ² *2

*1 In the linear servo motor control mode, the unit is mm/s.

*2 The command unit can be changed to 0.001 mm, 0.0001 inch, 0.001 degree or pulses with [Pr. PT01.2 Unit for position data]. The actual servo motor speed (encoder pulse unit) is calculated by multiplying the set speed data by the electronic gear ratio.

The speed of point table and the unit of acceleration/deceleration are changed depending on the setting value of this servo parameter. When the unit is changed, review and reset the point table setting value.

Enabled servo parameters vary depending on whether the setting value of this servo parameter is "0" or "1". Refer to the following table.

Setting value		Object interlocked with servo parameter
0	1	
[Pr. PT65 Profile speed command]	[Pr. PV01 Profile speed command extension setting]	[Profile velocity (Obj. 6081h)]
[Pr. PT66 Maximum profile speed]	[Pr. PV03 Maximum profile speed extension setting]	[Max profile velocity (Obj. 607Fh)]
[Pr. PT49 Speed acceleration time constant]	[Pr. PV05 Profile acceleration]	[Profile acceleration (Obj. 6083h)]
[Pr. PT50 Speed deceleration time constant]	[Pr. PV07 Profile deceleration]	[Profile deceleration (Obj. 6084h)]
[Pr. PC24 Deceleration time constant at forced stop]	[Pr. PV09 Deceleration at forced stop]	[Quick stop deceleration (Obj. 6085h)]
[Pr. PT05 Homing speed]	[Pr. PV11 Homing speed extension setting]	[Speed during search for switch (Obj. 6099h: 01h)]
[Pr. PT06 Creep speed]	[Pr. PV13 Creep speed extension setting]	[Speed during search for zero (Obj. 6099h: 02h)]
[Pr. PT56 Homing acceleration time constant]	[Pr. PV15 Homing acceleration]	[Homing acceleration (Obj. 609Ah)]
[Pr. PT57 Homing deceleration time constant]	[Pr. PV17 Homing deceleration]	—
[Pr. PC72 Speed reached 2 - Output range]	[Pr. PV19 Speed reached 2 - Output range - Extension setting]	[Velocity window (Obj. 606Dh)]
[Pr. PC65 Zero speed 2 level]	[Pr. PV20 Zero speed 2 level extension setting]	[Velocity threshold (Obj. 606Fh)]
[Pr. PT67 Speed limit]	[Pr. PV21 Speed limit extension setting]	[Velocity limit value (Obj. 2D20h)]
[Pr. PD32 Master-slave operation - Slave-side speed limit adjusted value]	[Pr. PV33 Master-slave operation - Speed limit adjusted value extension setting]	[Master-slave Lower limit of velocity limit value (Obj. 2E46h)]

[Pr. PT01.2_Unit for position data]

Initial value	Setting range	Ver.
3h	Refer to the text	B6

0: mm

1: inch

2: degree

3: pulse

If this servo parameter is changed, perform homing.

Refer to the following for the supported control mode and firmware version.

Control mode	Setting value			
	0 (mm) ^{*4}	1 (inch) ^{*4}	2 (degree) ^{*1*2}	3 (pulse)
Cyclic synchronous mode	—	—	— ^{*3}	A0
Profile mode	—	—	B6	A5
Positioning mode (point table method)	B8	B8	B8	B8

*1 When [Pr. PA01.4 Fully closed loop operation mode selection] is set to "1" (enabled), use a rotary encoder as the load-side encoder. Connecting a linear encoder will trigger [AL. 037 Parameter error].

*2 If [Pr. PA01.1 Operation mode selection] is set to "4" (linear servo motor control mode), [AL. 037] will occur.

*3 When this servo parameter is set to "2", the control mode cannot be switched to the cyclic synchronous mode.

*4 If this value is set in a mode other than the positioning mode (point table method), [AL. 037] will occur.

[Pr. PT02_Function selection T-1 (*TOP1)]

Initial value	Setting range	Setting method	Ver.
00000001h	Refer to the relevant detail No.	Each axis	Refer to the relevant detail No.

[Pr. PT02.7_Internal position command - Process speed selection]

Initial value	Setting range	Ver.
0h	Refer to the text	A5

Select the process speed of the position commands generated in the servo amplifier.

Setting "1" on a multi-axis servo amplifier triggers [AL. 037 Parameter error].

0: Standard

1: High speed

[Pr. PT03_Feed function selection (*FTY)]

Initial value	Setting range	Setting method	Ver.
00000000h	Refer to the relevant detail No.	Each axis	Refer to the relevant detail No.

[Pr. PT03.2_Degree unit rotation direction selection]

Initial value	Setting range	Ver.
0h	Refer to the text	B6

Select the rotation direction for when [Pr. PT01.2 Unit for position data] is set to "2" (degree).

0: Specified rotation direction

1: Rotation in the direction with the shortest distance

2: Rotation in the address decreasing direction

3: Rotation in the address increasing direction

This function is enabled in the profile position mode and positioning mode (point table method).

When [Pr. PT01.2] is set to a value other than "2", this parameter is disabled.

This servo parameter corresponds to [Positioning option code (Obj. 60F2h)].

Once this servo parameter is changed, the setting will be enabled immediately.

When an object is mapped in cyclic communication, the controller overwrites the value written with engineering software.

Thus, do not write a value with engineering software.

When the relative position command is set for the auxiliary function of the point table in the positioning mode (point table method), this servo parameter is disabled.

[Pr. PT05_Homing speed (ZRF)]

Initial value	Setting range	Setting method	Ver.
100.00 [r/min], [mm/s]	0.00 to 167772.15	Each axis	A0

Set the servo motor speed for homing.

The servo motor speed is clamped at the maximum speed. When changing the speed to the permissible speed, set the speed in [Pr. PA28.4 Speed range limit selection].

If the set speed exceeds 8000 r/min (mm/s), the speed is clamped at 8000 r/min (mm/s). However, the set speed is clamped when [Pr. PT02.7 Internal position command - Process speed selection] is set to "0".

This function corresponds to [Speed during search for switch (Obj. 6099h: 01h)].

When an object is mapped in cyclic communication, the controller overwrites the value written with engineering software.

Thus, do not write a value with engineering software.

This function is enabled when [Pr. PT01.1 Speed/acceleration/deceleration unit selection] is set to "0". This function and [Pr. PV11 Homing speed extension setting] are mutually exclusive.

[Pr. PT06_Creep speed (CRF)]

Initial value	Setting range	Setting method	Ver.
10.00 [r/min], [mm/s]	0.00 to 167772.15	Each axis	A0

When performing a homing, set the servo motor speed after proximity dog.

The servo motor speed is clamped at the maximum speed. When changing the speed to the permissible speed, set the speed in [Pr. PA28.4 Speed range limit selection].

If the set speed exceeds 8000 r/min (mm/s), the speed is clamped at 8000 r/min (mm/s). However, the set speed is clamped when [Pr. PT02.7 Internal position command - Process speed selection] is set to "0".

This function corresponds to [Speed during search for zero (Obj. 6099h: 02h)].

When an object is mapped in cyclic communication, the controller overwrites the value written with engineering software.

Thus, do not write a value with engineering software.

This function is enabled when [Pr. PT01.1] is set to "0". This function and [Pr. PV13 Creep speed extension setting] are mutually exclusive.

[Pr. PT07_Home position shift distance (ZST)]

Initial value	Setting range	Setting method	Ver.
0 [Command unit]	-2147483648 to 2147483647	Each axis	A0

Set the home position shift travel distance at homing.

The command unit can be changed to 0.001 mm, 0.0001 inch, 0.001 degree or pulses with [Pr. PT01.2 Unit for position data].

 Page 166 [Pr. PT01.2_Unit for position data]

The setting range is -359.999 to 359.999 degrees for the degree unit. If a value exceeding 360.000 degrees or less than -360.000 degrees is set, the value will be converted into the remainder obtained by dividing the setting value by 360.000.

-214748364 to -1 can be set on servo amplifiers with firmware version D0 or later.

[Pr. PT08_Homing position data (ZPS)]

Initial value	Setting range	Setting method	Ver.
0 [Command unit]	-2147483648 to 2147483647	Each axis	A0

Set the address that is to be the reference point of the machine coordinate system.

Subtracting the setting value of this servo parameter from the machine home position gives the coordinate of the home position. The value in [Position actual value (Obj. 6064h)] changes at the same time as the homing completion.

The setting value of this servo parameter is reflected at completion of homing or when the servo amplifier is connected to a network.

This function is enabled in the cyclic synchronous position mode, profile position mode, and positioning mode (point table method).

The command unit can be changed to 0.001 mm, 0.0001 inch, 0.001 degree or pulses with [Pr. PT01.2 Unit for position data].

Page 166 [Pr. PT01.2_Unit for position data]

If [Pr. PT01.2] is changed, the homing position data will also be changed. Execute homing again.

This function corresponds to [Home offset (Obj. 607Ch)]. The relation between [Home offset] and this servo parameter is as follows.

$$[\text{Home offset}] = - [\text{Pr. PT08}]$$

The value that is set in this servo parameter is not reflected when the homing is incomplete.

Setting this servo parameter will compensate the software position limit.

After compensation, [Max position range limit (607Dh: 02h)] = [Max position range limit] - [Home offset]

After compensation, [Min position range limit (607Dh: 01h)] = [Min position range limit] - [Home offset]

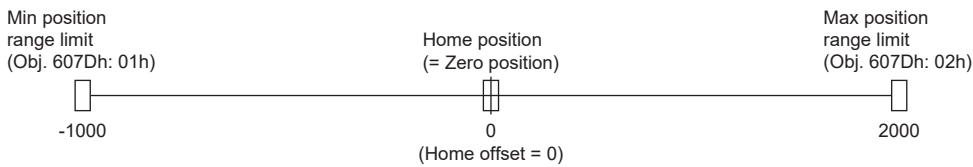

- For Home offset < 0

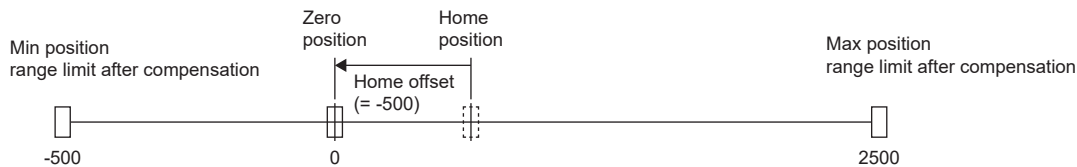

- For Home offset > 0

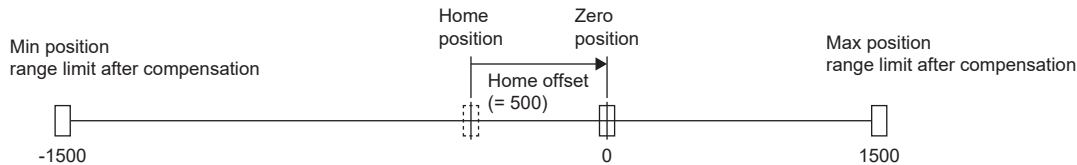

The setting range is 0 to 359.999 degrees for the degree unit. If a value out of the setting range is set, the value will be converted as shown in the table below.

Setting value	After conversion
360.000 to 2147483.647 degrees	The remainder obtained by dividing the setting value by 360.000
-0.001 to -359.999 degrees	The value obtained by adding 360.000 to the setting value
-360.000 to -2147483.648 degrees	The value obtained by adding 360.000 to the remainder after dividing the setting value by 360.000

[Pr. PT09_Travel distance after proximity dog (DCT)]

Initial value	Setting range	Setting method	Ver.
1000 [Command unit]	0 to 2147483647	Each axis	A0

Set a travel distance after proximity dog at homing for the count type (Front end detection Z-phase reference) (Homing method -2, -34) and dog reference.

The following shows the homing of the dog reference.

- Dog type rear end reference homing (Homing method -6, -38)
- Count type homing (Front end reference) (Homing method -7, -39)
- Dog type front end reference homing (Homing method -10, -42)
- Homing without index pulse (Homing method 19, 20, 21, 22, 23, 24, 27, 28)

This function is enabled in the cyclic synchronous mode, profile mode, and positioning mode (point table method).

The command unit can be changed to 0.001 mm, 0.0001 inch, 0.001 degree or pulses with [Pr. PT01.2 Unit for position data].

☞ Page 166 [Pr. PT01.2_Unit for position data]

The setting range is 0 to 359.999 degrees for the degree unit. If a value exceeding 360.000 degrees is set, the value will be converted into the remainder obtained by dividing the setting value by 360.000.

[Pr. PT10_Stopper type homing - Stopping time (ZTM)]

Initial value	Setting range	Setting method	Ver.
100 [ms]	5 to 1000	Each axis	A0

Set a time from a moving part touches the stopper and torques reach to the torque limit of [Pr. PT11 Stopper type homing - Torque limit value] to a home position is set for the stopper type homing.

This function is enabled in the cyclic synchronous mode, profile mode, and positioning mode (point table method).

[Pr. PT11_Stopper type homing - Torque limit value (ZTT)]

Initial value	Setting range	Setting method	Ver.
15.0 [%]	0.1 to 100.0	Each axis	A0

Set a torque limit value with [%] unit to the rated torque at stopper type homing.

This function is enabled in the cyclic synchronous mode, profile mode, and positioning mode (point table method).

[Pr. PT12_Rough match output range (CRP)]

Initial value	Setting range	Setting method	Ver.
0 [Command unit]	0 to 2147483647	Each axis	A5

Set the range of the command remaining distance to output the rough match.

This function is enabled in the profile position mode and positioning mode (point table method).

The command unit can be changed to 0.001 mm, 0.0001 inch, 0.001 degree or pulses with [Pr. PT01.2 Unit for position data].

☞ Page 166 [Pr. PT01.2_Unit for position data]

[Pr. PT15_Software position limit + (LMP)]

Initial value	Setting range	Setting method	Ver.
0 [Command unit]	-2147483648 to 2147483647	Each axis	A0

Set the address increasing side of the software position limit.

This function is enabled in the cyclic synchronous position mode, profile position mode, and positioning mode (point table method). This function is disabled during homing.

The command unit can be changed to 0.001 mm, 0.0001 inch, 0.001 degree or pulses with [Pr. PT01.2 Unit for position data].

 Page 166 [Pr. PT01.2_Unit for position data]

Change this function during servo-off, in the homing mode, velocity mode, or torque mode.

When the setting is changed during servo-on in the position mode and positioning mode, [AL. 035 Command frequency error], [AL. 069 Command error], and [AL. 098 Software position limit warning] may occur, depending on the setting order of [Pr. PT15] and [Pr. PT17 Software position limit -].

This function corresponds to [Max position limit (Obj. 607Dh: 02h)].

When an object is mapped in cyclic communication, the controller overwrites the value written with engineering software.

Thus, do not write a value with engineering software.

The enabling/disabling conditions of the software position limit are shown in the table below.

[Pr. PT01.2]	Conditions		
	[Pr. PT15] > [Pr. PT17]	[Pr. PT15] < [Pr. PT17]	[Pr. PT15] = [Pr. PT17]
0 (mm) 1 (inch) 3 (pulse)	Enabled	Disabled	Disabled
2 (degree)	Enabled	Enabled	Disabled

[Pr. PT17_Software position limit - (LMN)]

Initial value	Setting range	Setting method	Ver.
0 [Command unit]	-2147483648 to 2147483647	Each axis	A0

Set the address decreasing side of the software position limit.

The other specifications are the same as [Pr. PT15].

[Pr. PT19_Position range output 1 address + (*LPP1)]

Initial value	Setting range	Setting method	Ver.
0 [Command unit]	-2147483648 to 2147483647	Each axis	A5

Set the address increasing side of the position range output 1 address.

Use this servo parameter and [Pr. PT21 Position range output 1 address -] to set the range where position range 1 (POT1) turns on.

This function is enabled in the profile position mode and positioning mode (point table method).

The command unit can be changed to 0.001 mm, 0.0001 inch, 0.001 degree or pulses with [Pr. PT01.2 Unit for position data].

☞ Page 166 [Pr. PT01.2_Unit for position data]

If [Pr. PT19] is set to a value less than [Pr. PT21] while [Pr. PT01.2] is set to "3" (pulse), [AL. 037 Parameter error] occurs.

When [Pr. PT01.2] is set to "2" (degree), set [Pr. PT21] as the starting point and [Pr. PT19] as the ending point.

An example setting of the degree unit is as follows.

The output range is the section where the servo motor moves from "-" to "+" in the CCW direction.

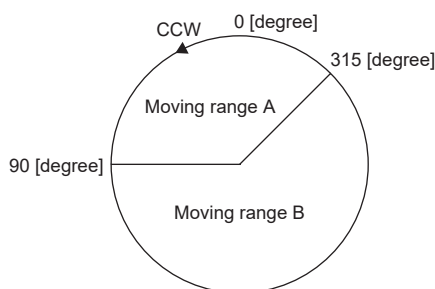

Set the output range of moving range A as follows:

- [Pr. PT21] = 315.000 degrees
- [Pr. PT19] = 90.000 degrees

Set the output range of moving range B as follows:

- [Pr. PT21] = 90.000 degrees
- [Pr. PT19] = 315.000 degrees

The setting range is 0 to 359.999 degrees. If a value out of the setting range is set, the value will be converted as shown in the table below.

The values of the output range shown above will be the values after conversion.

Setting value	After conversion
360.000 to 2147483.647 degrees	The remainder obtained by dividing the setting value by 360.000
-0.001 to -359.999 degrees	The value obtained by adding 360.000 to the setting value
-360.000 to -2147483.648 degrees	The value obtained by adding 360.000 to the remainder after dividing the setting value by 360.000

[Pr. PT21_Position range output 1 address - (*LNP1)]

Initial value	Setting range	Setting method	Ver.
0 [Command unit]	-2147483648 to 2147483647	Each axis	A5

Set the address decreasing side of the position range output 1 address.

The other specifications are the same as [Pr. PT19 Position range output 1 address +].

[Pr. PT26_Function selection T-2 (*TOP2)]

Initial value	Setting range	Setting method	Ver.
00000000h	Refer to the relevant detail No.	Each axis	Refer to the relevant detail No.

[Pr. PT26.4_Touch probe latch position selection]

Initial value	Setting range	Ver.
0h	0h to 2h	C4

Select the reflecting patterns of [Pr. PA14 Travel direction selection] and [Pr. PT08 Homing position data] to the latch position in the touch probe function.

0: Reflect only some of the patterns of [Pr. PA14]

2: Reflect all the patterns of [Pr. PA14] and [Pr. PT08]

The reflecting patterns are as follows.

[Pr. PT26.4]	Trigger *1 [Touch probe function (Obj. 60B8h)] [Touch probe function 2 (Obj. 2DE8h)]	[Pr. PT01.2 Unit for position data]	Reflecting the setting value of [Pr. PA14]	Reflecting the setting value of [Pr. PT08]
0	0 (Triggered by inputting touch probe)	0 (mm), 1 (inch), 3 (pulse)	<input type="radio"/>	—
		2 (degree)	—	<input type="radio"/>
	1 (Triggered at the zero point of the encoder)	0, 1, 3	<input type="radio"/>	—
		2	<input type="radio"/>	—
2	0 (Triggered by inputting touch probe)	0, 1, 3	<input type="radio"/>	<input type="radio"/>
		2	<input type="radio"/>	<input type="radio"/>
	1 (Triggered at the zero point of the encoder)	0, 1, 3	<input type="radio"/>	<input type="radio"/>
		2	<input type="radio"/>	<input type="radio"/>

*1 The trigger corresponds to bit 2 or bit 10 of [Touch probe function (Obj. 60B8h)] or bit 2 of [Touch probe function 2 (Obj. 2DE8h)]. The applicable object differs depending on the touch probe device being used.

[Pr. PT29_Function selection T-3 (*TOP3)]

Initial value	Setting range	Setting method	Ver.
00000000h	Refer to the relevant detail No.	Each axis	Refer to the relevant detail No.

[Pr. PT29.0_Device input polarity 1]

Initial value	Setting range	Ver.
0h	Refer to the text	A0

Select the proximity dog input polarity.

0: Dog detection with off

1: Dog detection with on

[Pr. PT34_Positioning operation data default (**PDEF)]

Initial value	Setting range	Setting method	Ver.
00000000h	Refer to the relevant detail No.	Each axis	Refer to the relevant detail No.

[Pr. PT34.0_Point table default]

Initial value	Setting range	Ver.
0h	Refer to the text	B8

0: Disabled

1: Enabled

When initializing the point table, set "1".

After setting [Pr. PT34.0] = "1" and [Pr. PT34.3 Default availability] = "5" (permitted), cycle the power or reset the software to initialize the point table.

After the initialization is completed, the setting value of [Pr. PT34] is automatically set to "00000000h".

[Pr. PT34.3_Default availability]

Initial value	Setting range	Ver.
0h	Refer to the text	B8

0: Prohibited

5: Permitted

When initializing the point table, set "5".

After the initialization is completed, the setting value of [Pr. PT34] is automatically set to "00000000h".

[Pr. PT38_Function selection T-7 (**TOP7)]

Initial value	Setting range	Setting method	Ver.
00000000h	Refer to the relevant detail No.	Each axis	Refer to the relevant detail No.

[Pr. PT38.1_Override selection]

Initial value	Setting range	Ver.
0h	Refer to the text	D4

Select the override function.

0: The override function is disabled.

3: The override function is enabled.

When the setting value of this servo parameter is "3" (the override function is enabled), the override function can be used in the profile position mode (pp), point table mode (pt), JOG operation mode (jg), and homing mode (hm).

[Pr. PT38.4_Limit switch release position assessment function selection]

Initial value	Setting range	Ver.
0h	Refer to the text	B2

Set the limit switch release position assessment function.

This function is enabled in the cyclic synchronous position mode or the cyclic synchronous speed mode.

Refer to the following table for the combinations available for the assessment function.

Setting value	Limit switch release position assessment function
0	Disabled
1	Enabled

[Pr. PT41_Function selection T-8 (TOP8)]

Initial value	Setting range	Setting method	Ver.
00000000h	Refer to the relevant detail No.	Each axis	Refer to the relevant detail No.

[Pr. PT41.0_Homing prohibition selection]

Initial value	Setting range	Ver.
0h	Refer to the text	A0

0: Disabled

1: Enabled

When "1" is set, the homing is not performed even if the start signal is turned on in the homing mode.

[Pr. PT45_Homing method (HMM)]

Initial value	Setting range	Setting method	Ver.
37	Refer to the text	Each axis	A0

Set a homing method.

An attempt to execute homing with an unsupported method triggers "Homing error". At this time, homing cannot be executed.

This function corresponds to [Homing method (Obj. 6098h)].

When an object is mapped in cyclic communication, the controller overwrites the value written with engineering software.

Thus, do not write a value with engineering software.

For servo amplifiers with firmware version D4 or later, the setting of [Pr. PA14 Travel direction selection (*POL)] can be reflected to the homing direction depending on the setting value of [Pr. PT55.1 Homing POL reflection selection]. For details of the homing direction, refer to "Homing mode (hm)" in the MR-JET User's Manual (Function).

• Homing methods

For details of the homing method, refer to "Homing mode (hm)" in the MR-JET User's Manual (Function).

Setting	Homing direction *3		Homing methods	Description
	[Pr. PA14] = 0	[Pr. PA14] = 1		
-1	Forward rotation (CCW) or positive direction	Reverse rotation (CW) or negative direction	Dog type (Rear end detection - Z-phase reference)	Performs homing using the Z-phase pulse after a moving part has moved past the proximity dog. Deceleration starts from the front end of the proximity dog. After the rear end is passed, the position specified by the first Z-phase signal or the position of the first Z-phase signal shifted by the specified home position shift distance is used as the home position.
-2			Count type (Front end detection - Z-phase reference)	Performs homing using the encoder pulse count after a moving part came into contact with the proximity dog. Deceleration starts from the front end of the proximity dog. After the front end is passed, the position specified by the first Z-phase signal after the set distance or the position of the Z-phase signal shifted by the set home position shift distance is set as the home position.
-3	—	—	Data set type	Performs homing without a dog. The current position is set as the home position. Homing can be executed in the Operational enabled state. Homing cannot be executed in the servo-off status.
-4	Forward rotation (CCW) or positive direction	Reverse rotation (CW) or negative direction	Stopper type (Stopper position reference)	Performs homing with a workpiece pressed against a mechanical stopper. A workpiece is pressed against a mechanical stopper, and the stop position is set as the home position.
-6			Dog type (Rear end detection - rear end reference)	Performs homing with reference to the rear end of the proximity dog. Deceleration starts from the front end of the proximity dog. After the rear end is passed, the position is shifted by the travel distance after proximity dog and the home position shift distance. The position after the shifts is set as the home position.
-7			Count type (Front end detection - front end reference)	Performs homing with reference to the front end of the proximity dog. Deceleration starts from the front end of the proximity dog. The position is shifted by the travel distance after the proximity dog and the home position shift distance. The position after the shifts is set as the home position.
-8			Dog cradle type	Performs homing using the first Z-phase pulse with reference to the front end of the proximity dog. The position specified by either the first Z-phase signal after the front end of the proximity dog is detected or the position of the first Z-phase signal shifted by the home position shift distance can be set as the home position.
-9			Dog type last Z-phase reference	Performs homing using the last Z-phase pulse with reference to the front end of the proximity dog. After the front end of the proximity dog is detected, the position is shifted away from the proximity dog in the reverse direction. Then, the position specified by the first Z-phase signal or the position of the first Z-phase signal shifted by the home position shift distance is used as the home position.
-10			Dog type front end reference	Performs homing with reference to the front end of the proximity dog in the direction of the front end. Starting from the front end of the proximity dog, the position is shifted by the travel distance after the proximity dog and the home position shift distance. The position after the shifts is set as the home position.

Setting	Homing direction *3		Homing methods	Description		
	[Pr. PA14] = 0	[Pr. PA14] = 1				
-11	Forward rotation (CCW) or positive direction	Reverse rotation (CW) or negative direction	Dogless Z-phase reference	Performs homing with reference to the first Z-phase in the direction of the dog front end. The position specified by the first Z-phase signal or the position of the first Z-phase signal shifted by the home position shift distance is used as the home position.		
-33	Reverse rotation (CW) or negative direction	Forward rotation (CCW) or positive direction	Dog type (Rear end detection - Z-phase reference)	The same as the setting -1.		
-34			Count type (Front end detection - Z-phase reference)	The same as the setting -2.		
-36			Stopper type (Stopper position reference)	The same as the setting -4.		
-38			Dog type (Rear end detection - rear end reference)	The same as the setting -6.		
-39			Count type (Front end detection - front end reference)	The same as the setting -7.		
-40			Dog cradle type	The same as the setting -8.		
-41			Dog type last Z-phase reference	The same as the setting -9.		
-42			Dog type front end reference	The same as the setting -10.		
-43			Dogless Z-phase reference	The same as the setting -11.		
1 *1					Method 1 (Homing on negative limit switch and index pulse)	After the reverse rotation stroke end is detected, the position moves in the opposite direction. Then, the position specified by either the first Z-phase signal after leaving the stroke end or the position of the first Z-phase signal shifted by the home position shift distance can be set as the home position. If the position is shifted in the forward rotation direction, and the forward rotation stroke end is detected before the Z-phase signal is detected, [AL. 090 Homing incomplete warning] will occur. When FLS/RLS is used, this homing method is available on servo amplifiers with firmware version C0 or later.
2 *1			Forward rotation (CCW) or positive direction	Reverse rotation (CW) or negative direction	Method 2 (Homing on positive limit switch and index pulse)	After the forward rotation stroke end is detected, the position moves in the opposite direction. Then, the position specified by either the first Z-phase signal after leaving the stroke end or the position of the first Z-phase signal shifted by the home position shift distance can be set as the home position. If the position is shifted in the reverse rotation direction, and the reverse rotation stroke end is detected before the Z-phase signal is detected, [AL. 090 Homing incomplete warning] will occur. When FLS/RLS is used, this homing method is available on servo amplifiers with firmware version C0 or later.
3	Method 3 (Homing on positive home switch and index pulse)	This is the same as the dog type last Z-phase reference homing. If the stroke end is detected during homing, [AL. 090 Homing incomplete warning] will occur.				
4	Method 4 (Homing on positive home switch and index pulse)	This is the same as the dog cradle type homing. If the stroke end is detected during homing, [AL. 090 Homing incomplete warning] will occur.				
5	Reverse rotation (CW) or negative direction	Forward rotation (CCW) or positive direction	Method 5 (Homing on negative home switch and index pulse)	This is the same as the dog type last Z-phase reference homing. If the stroke end is detected during homing, [AL. 090 Homing incomplete warning] will occur.		
6			Method 6 (Homing on negative home switch and index pulse)	This is the same as the dog cradle type homing. If the stroke end is detected during homing, [AL. 090 Homing incomplete warning] will occur.		

Setting	Homing direction *3		Homing methods	Description
	[Pr. PA14] = 0	[Pr. PA14] = 1		
7	Forward rotation (CCW) or positive direction	Reverse rotation (CW) or negative direction	Method 7 (Homing on home switch and index pulse)	This is the same as the dog type last Z-phase reference homing.
8			Method 8 (Homing on home switch and index pulse)	This is the same as the dog cradle type homing.
9 *2			Method 9 (Homing on home switch and index pulse)	With reference to the rear end of the proximity dog, the home position is the Z-phase pulse immediately before the rear end of the dog. With this homing method, the position shifted by the home position shift distance is used as the home position.
10 *2			Method 10 (Homing on home switch and index pulse)	With reference to the rear end of the proximity dog, the home position is the Z-phase pulse immediately before the rear end of the dog. With this homing method, the position shifted by the home position shift distance is used as the home position.
11	Reverse rotation (CW) or negative direction	Forward rotation (CCW) or positive direction	Method 11 (Homing on home switch and index pulse)	This is the same as the dog type last Z-phase reference homing.
12			Method 12 (Homing on home switch and index pulse)	This is the same as the dog cradle type homing.
13 *2			Method 13 (Homing on home switch and index pulse)	The same as the setting 9.
14 *2			Method 14 (Homing on home switch and index pulse)	The same as the setting 10.
17 *2			Method 17 (Homing without index pulse)	After the reverse rotation stroke end is detected, the position is shifted away from the stroke end in the forward direction, where the home position is set. With this homing method, the position shifted by the home position shift distance is used as the home position. If the position is shifted in the forward rotation direction, and the forward rotation stroke end is detected, [AL. 090 Homing incomplete warning] will occur.
18 *2	Forward rotation (CCW) or positive direction	Reverse rotation (CW) or negative direction	Method 18 (Homing without index pulse)	After the forward rotation stroke end is detected, the position is shifted away from the stroke end in the reverse direction, where the home position is set. With this homing method, the position shifted by the home position shift distance is used as the home position. If the position is shifted in the reverse rotation direction, and the reverse rotation stroke end is detected, [AL. 090 Homing incomplete warning] will occur.
19			Method 19 (Homing without index pulse)	This is the same as the dog type front end reference homing. If the stroke end is detected during homing, [AL. 090 Homing incomplete warning] will occur.
20			Method 20 (Homing without index pulse)	Although this type is the same as the dog cradle type homing, the stop position is not on the Z-phase. Starting from the front end of the dog, the position is shifted by the travel distance after proximity dog and the home position shift distance. The position after the shifts is set as the home position. If the stroke end is detected during homing, [AL. 090 Homing incomplete warning] will occur.

Setting	Homing direction ^{*3}		Homing methods	Description
	[Pr. PA14] = 0	[Pr. PA14] = 1		
21	Reverse rotation (CW) or negative direction	Forward rotation (CCW) or positive direction	Method 21 (Homing without index pulse)	This is the same as the dog type front end reference homing. If the stroke end is detected during homing, [AL. 090 Homing incomplete warning] will occur.
22			Method 22 (Homing without index pulse)	Although this type is the same as the dog cradle type homing, the stop position is not on the Z-phase. Starting from the front end of the dog, the position is shifted by the travel distance after proximity dog and the home position shift distance. The position after the shifts is set as the home position. If the stroke end is detected during homing, [AL. 090 Homing incomplete warning] will occur.
23	Forward rotation (CCW) or positive direction	Reverse rotation (CW) or negative direction	Method 23 (Homing without index pulse)	This is the same as the dog type front end reference homing.
24			Method 24 (Homing without index pulse)	Although this type is the same as the dog cradle type homing, the stop position is not on the Z-phase. Starting from the front end of the dog, the position is shifted by the travel distance after proximity dog and the home position shift distance. The position after the shifts is set as the home position.
27	Reverse rotation (CW) or negative direction	Forward rotation (CCW) or positive direction	Method 27 (Homing without index pulse)	This is the same as the dog type front end reference homing.
28			Method 28 (Homing without index pulse)	Although this type is the same as the dog cradle type homing, the stop position is not on the Z-phase. Starting from the front end of the dog, the position is shifted by the travel distance after proximity dog and the home position shift distance. The position after the shifts is set as the home position.
33			Method 33 (Homing on index pulse)	Although this type is the same as the dogless Z-phase reference homing, the creep speed is applied as the movement start speed.
34	Forward rotation (CCW) or positive direction	Reverse rotation (CW) or negative direction	Method 34 (Homing on index pulse)	Although this type is the same as the dogless Z-phase reference homing, the creep speed is applied as the movement start speed.
35	—	—	Method 35 (Homing on current position)	The current position is set as the home position. Homing can be executed even when the servo amplifier is not in the Operational enabled state. Homing can be executed in the servo-off status as well.
37			Method 37 (Homing on current position)	The current position is set as the home position. Homing can be executed even when the servo amplifier is not in the Operational enabled state. Homing can be executed in the servo-off status as well.

*1 Available on servo amplifiers with firmware version B2 or later.

*2 Available on servo amplifiers with firmware version C0 or later.

*3 When "1" is set in [Pr. PT55.1 Homing POL reflection selection] for servo amplifiers with firmware version D4 or later, the setting value of [Pr. PA14 Travel direction selection (*POL)] is reflected at homing.

[Pr. PT49_Speed acceleration time constant (STA)]

Initial value	Setting range	Setting method	Ver.
0 [ms]	0 to 50000	Each axis	A5

Set the acceleration time taken by the motor to reach the rated speed from a full stop for the command.

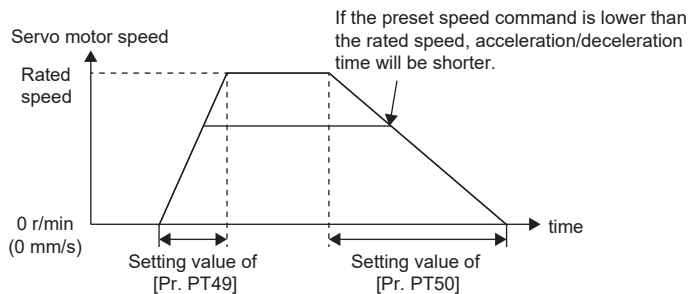

For example, for a servo motor with a rated speed of 3000 [r/min], set 3000 [ms] to accelerate from 0 [r/min] to 1000 [r/min] in 1000 [ms].

This function corresponds to [Profile acceleration (Obj. 6083h)].

When an object is mapped in cyclic communication, the controller overwrites the value written with engineering software.

Thus, do not write a value with engineering software.

This function is enabled when [Pr. PT01.1 Speed/acceleration/deceleration unit selection] is set to "0". This function and [Pr. PV05 Profile acceleration] are mutually exclusive.

When "1" is set in [Pr.PT01.1] in the point table mode (pt), the servo motor accelerates in accordance with the setting value of this servo parameter if "0" is set in the acceleration ([Acceleration (Obj. 2801h to 28FFh: 03h)]).

- Profile mode

This function is enabled in the profile position mode and profile velocity mode.

If a value larger than 20000 [ms] is set in the position mode, [AL. 0F4 Positioning warning] occurs.

- Positioning mode (point table method)

This function is enabled in the JOG operation mode.

If a value larger than 20000 [ms] is set in the JOG operation mode, [AL. 0F4 Positioning warning] occurs.

[Pr. PT50_Speed deceleration time constant (STB)]

Initial value	Setting range	Setting method	Ver.
0 [ms]	0 to 50000	Each axis	A5

Set the deceleration time from the rated speed to a motor stop for the command.

This function corresponds to [Profile deceleration (Obj. 6084h)].

When an object is mapped in cyclic communication, the controller overwrites the value written with engineering software.

Thus, do not write a value with engineering software.

This function is enabled when [Pr. PT01.1 Speed/acceleration/deceleration unit selection] is set to "0". This function and [Pr. PV07 Profile deceleration] are mutually exclusive.

When "1" is set in [Pr.PT01.1] in the point table mode (pt), the servo motor decelerates in accordance with the setting value of this servo parameter if "0" is set in the deceleration ([Deceleration (Obj. 2801h to 28FFh: 04h)]).

- Profile mode

This function is enabled in the profile position mode and profile velocity mode.

If a value larger than 20000 [ms] is set in the position mode, [AL. 0F4 Positioning warning] occurs.

- Positioning mode (point table method)

This function is enabled in the JOG operation mode.

If a value larger than 20000 [ms] is set in the JOG operation mode, [AL. 0F4 Positioning warning] occurs.

[Pr. PT51_S-pattern acceleration/deceleration time constants (STC)]

Initial value	Setting range	Setting method	Ver.
0 [ms]	0 to 5000	Each axis	A5

Set the time of the arc part for S-pattern acceleration/deceleration time constants.

This setting enables smooth start/stop of the servo motor.

When "0" is set, linear acceleration/deceleration is performed.

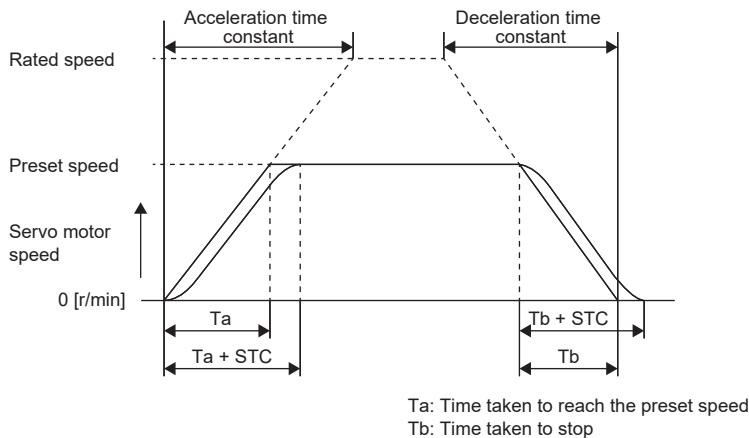

This function is enabled in the profile position mode, profile velocity mode, and positioning mode (point table method).

This function is disabled during homing.

In the profile velocity mode, if a long acceleration or deceleration time is set, a timing error may occur on the arc part against the setting of the S-pattern acceleration deceleration time constants.

The upper limit of the actual time for the arc part is limited to 2000000/acceleration time during acceleration and 2000000/ deceleration time during deceleration.

Ex.

At the setting of STA ([Pr. PT49 Speed acceleration time constant]) = 20000, STB ([Pr. PT50 Speed deceleration time constant]) = 5000, and STC = 200, the actual time for the arc part is as follows.

During acceleration: 100 [ms]

$$2000000/20000 = 100 \text{ [ms]} < 200 \text{ [ms]}$$

Therefore, the time is limited to 100 [ms].

During deceleration: 200 [ms]

$$2000000/5000 = 400 \text{ [ms]} > 200 \text{ [ms]}$$

Therefore, it will be 200 [ms] as set.

- Profile position mode and positioning mode (point table method)

If a value of 1000 [ms] or more is set, the value is clamped to 1000 [ms].

The setting is enabled at the next operation start.

[Pr. PT53_Torque slope (TQS)]

Initial value		Setting range	Setting method	Ver.
J5G	J5G-N1			
0.0 [%/s]	100.0 [%/s]	0.0 to 1000000.0	Each axis	A5

Set the rate of change in the torque command per second.

When "0.0" is set, the torque slope is disabled.

This function is enabled in the profile torque mode.

This function corresponds to [Torque slope (Obj. 6087h)].

When an object is mapped in cyclic communication, the controller overwrites the value written with engineering software.

Thus, do not write a value with engineering software.

[Pr. PT55_Function selection T-10 (*TOP10)]

Initial value	Setting range	Setting method	Ver.
00000000h	Refer to the relevant detail No.	Each axis	Refer to the relevant detail No.

[Pr. PT55.0_Homing deceleration time constant selection]

Initial value	Setting range	Ver.
0h	Refer to the text	A0

Set a value to be used for the acceleration time constant and deceleration time constant at homing.

Setting value	Acceleration time constant	Deceleration time constant
0	[Pr. PT56 Homing acceleration time constant] or [Pr. PV15 Homing acceleration]	
1	[Pr. PT56 Homing acceleration time constant] or [Pr. PV15 Homing acceleration]	[Pr. PT57 Homing deceleration time constant] or [Pr. PV17 Homing deceleration]

[Pr. PT55.1_Homing POL reflection selection]

Initial value	Setting range	Ver.
0h	Refer to the text	D4

When the setting value of this servo parameter is "1" (enabled) and the setting value of [Pr. PA14 Travel direction selection] is "1", the homing direction changes. For details of the homing direction, refer to "Homing mode (hm)" in the MR-JET User's Manual (Function).

0: Disabled

1: Enabled

[Pr. PT56_Homing acceleration time constant (HMA)]

Initial value	Setting range	Setting method	Ver.
0 [ms]	0 to 20000	Each axis	A0

Set the acceleration time constant for the homing.

Set the acceleration time taken for the motor to reach the rated speed from a full stop.

When [Pr. PT55.0 Homing deceleration time constant selection] is set to "0", this servo parameter is used as the deceleration time constant at homing.

This function corresponds to [Homing acceleration (Obj. 609Ah)].

When an object is mapped in cyclic communication, the controller overwrites the value written with engineering software.

Thus, do not write a value with engineering software.

This function is enabled when [Pr. PT01.1 Speed/acceleration/deceleration unit selection] is set to "0". This function and [Pr. PV15 Homing acceleration] are mutually exclusive.

[Pr. PT57_Homing deceleration time constant (HMB)]

Initial value	Setting range	Setting method	Ver.
0 [ms]	0 to 20000	Each axis	A0

Set the deceleration time constant at homing.

Set the deceleration time from the rated speed to a motor stop.

This servo parameter is enabled when [Pr. PT55.0 Homing deceleration time constant selection] is set to "1".

This function is enabled when [Pr. PT01.1 Speed/acceleration/deceleration unit selection] is set to "0". This function and [Pr. PV17 Homing deceleration] are mutually exclusive.

[Pr. PT65_Profile speed command (PVC)]

Initial value	Setting range	Setting method	Ver.
100.00 [r/min], [mm/s]	0.00 to 21474836.47	Each axis	A5

This function is enabled in the profile position mode and positioning mode (point table method).

This function corresponds to [Profile velocity (Obj. 6081h)].

When an object is mapped in cyclic communication, the controller overwrites the value written with engineering software.

Thus, do not write a value with engineering software.

This function is enabled when [Pr. PT01.1 Speed/acceleration/deceleration unit selection] is set to "0". This function and [Pr. PV01 Profile speed command extension setting] are mutually exclusive.

- Profile mode

Set the profile speed command.

If the set speed exceeds 8000 r/min (mm/s), the speed is clamped at 8000 r/min (mm/s).

However, the set speed is clamped when [Pr. PT02.7 Internal position command - Process speed selection] is set to "0" (standard).

- Positioning mode (point table method)

Set the JOG speed command.

[Pr. PT66_Maximum profile speed (MPVC)]

Initial value	Setting range	Setting method	Ver.
20000.00 [r/min], [mm/s]	0.00 to 20000.00	Each axis	A5

Set the maximum profile speed.

This function is enabled in the profile position mode and profile velocity mode.

This function corresponds to [Max profile velocity (Obj. 607Fh)].

When an object is mapped in cyclic communication, the controller overwrites the value written with engineering software.

Thus, do not write a value with engineering software.

This function is enabled when [Pr. PT01.1 Speed/acceleration/deceleration unit selection] is set to "0". This function and [Pr. PV03 Maximum profile speed extension setting] are mutually exclusive.

[Pr. PT67_Speed limit (VLMT)]

Initial value	Setting range	Setting method	Ver.
3000.00 [r/min], [mm/s]	0.00 to 21474836.47	Each axis	A0

Set the maximum speed in the torque control.

This function is enabled in the cyclic synchronous torque mode, the profile torque mode, and the continuous operation to torque control mode.

This function corresponds to [Velocity limit value (Obj. 2D20h)].

When an object is mapped in cyclic communication, the controller overwrites the value written with engineering software.

Thus, do not write a value with engineering software.

The speed is 3000 r/min in the initial setting. Change the setting value according to the intended use.

This function is enabled when [Pr. PT01.1 Speed/acceleration/deceleration unit selection] is set to "0". This function and [Pr. PV21 Speed limit extension setting] are mutually exclusive.

[Pr. PT68_Function selection T-11 (TOP11)]

Initial value	Setting range	Setting method	Ver.
00000002h	Refer to the relevant detail No.	Each axis	Refer to the relevant detail No.

[Pr. PT68.0_Quick stop method selection]

Initial value	Setting range	Ver.
2h	Refer to the text	A0

Select the quick stop method.

In the slave axis torque mode (slt), the servo motor ignores the Quick Stop input and decelerates to a stop in accordance with the stop command from the master axis regardless of the setting value of this servo parameter. For details, refer to "Master-slave operation simultaneous stop function" in the User's Manual (Communication Function).

Forced stop deceleration by turning off EM2 (Forced stop 2) is the same as "2" regardless of the setting value of this servo parameter.

When [Pr. PA04.3 Forced stop deceleration function selection] is set to "0" (forced stop deceleration function disabled), the servo motor stops with the dynamic brake regardless of the setting value of this servo parameter.

This function corresponds to [Quick stop option code (Obj. 605Ah)].

When an object is mapped in cyclic communication, the controller overwrites the value written with engineering software.

Thus, do not write a value with engineering software.

Setting value	Description
0 *1	Stop with dynamic brake
1 *1*3	Servo-off after deceleration to a stop at the deceleration time constant of any of the control modes
2	Servo-off after deceleration to a stop with [Quick stop deceleration (Obj. 6085h)]
5 *1*2*3*4*5	Maintain servo-on after deceleration to a stop at the deceleration time constant of any of the control modes
6 *1*2*4*5	Maintain servo-on after deceleration to a stop with [Quick stop deceleration (Obj. 6085h)]

*1 Available on servo amplifiers with firmware version D0 or later.

*2 Not available for CC-Link IE Field Network Basic.

*3 For the deceleration time constants of the control modes, refer to "[Quick stop option code (Obj. 605Ah)]" in the User's Manual (Object Dictionary).

*4 When the controller being used cannot perform follow-up in the "Quick stop active" state (during servo-on), do not use this setting value in the cyclic synchronous position mode (csp). For information on whether the controller being used can perform follow-up in the "Quick stop active" state, refer to the manual for the controller.

*5 When canceling Quick stop in the cyclic synchronous position mode (csp), cancel it after servo-off or perform position follow-up with the controller. If Quick stop is canceled without performing position follow-up, the servo motor may suddenly accelerate.

[Pr. PT68.2_Temporary stop method selection]

Initial value	Setting range	Ver.
0h	Refer to the text	A0

Select a temporary stop method.

0: Automatic selection (deceleration to a stop method)

1: Deceleration to a stop method

This function corresponds to [Halt option code (Obj. 605Dh)].

When an object is mapped in cyclic communication, the controller overwrites the value written with engineering software.

Thus, do not write a value with engineering software.

[Pr. PT83_Positioning function selection (*MOTOP)]

Initial value	Setting range	Setting method	Ver.
00000000h	Refer to the relevant detail No.	Each axis	Refer to the relevant detail No.

[Pr. PT83.2_Positioning function selection 2]

Initial value	Setting range	Ver.
0h	Refer to the text	D4

Select the positioning function.

Setting digit (BIN)	Functions
___x	M code update setting 0: After the remaining travel distance is cleared, the M code is updated. 1: After the remaining travel distance is cleared, the M code is not updated. Refer to "POSITIONING MODE (POINT TABLE METHOD) (CP) [G]" in the MR-J5 User's Manual (Function).
__x_	For manufacturer setting
_x__	For manufacturer setting
x___	For manufacturer setting

[Pr. PT85_Function selection T-14 (*TOP14)]

Initial value	Setting range	Setting method	Ver.
00000000h	Refer to the relevant detail No.	Each axis	Refer to the relevant detail No.

[Pr. PT85.0_Infinite feed function selection]

When the command interface of the servo amplifier is CC-Link IE TSN or EtherNet/IP, this servo parameter is not available.

Initial value	Setting range	Ver.
0h	Refer to the text	D0

Enable or disable the infinite feed function.

0: Disabled

1: Enabled

When [Pr. PT85.0] is changed while the absolute position detection system is enabled, perform homing again. If homing is not performed, [AL. 090.5 Homing incomplete warning] occurs at the start of an operation.

When the command interface of the servo amplifier is EtherNet/IP, setting a value other than "1" (enabled) triggers [AL. 037 Parameter error].

1.10 Network setting servo parameters group ([Pr. PN_ _])

[Pr. PN02_ Communication error - Detection time (CERT)]

When the command interface of the servo amplifier is EtherCAT or EtherNet/IP, this servo parameter is not available.

Initial value	Setting range	Setting method	Ver.
0 [ms]	0 to 1000	Common	A0

- For CC-Link IE TSN Class B

Set the threshold until network disconnecting and [AL. 086.2 Network communication error 2] are detected.

The maximum setting range is 1000 ms.

When "0" is set, the detection time is 10 ms.

- For CC-Link IE TSN Class A

Set the threshold until network disconnecting is detected.

When "0" is set, the detection time is 1000 ms.

Ex.

When "1000" is set, the set value becomes 1000 ms.

When [Pr. PD41.2 Limit switch enabled status selection] is set to "1" and [Pr. PD41.3 Sensor input method selection] is set to "1", setting a large value in this parameter prevents the limit switch from working at an occurrence of a communication error, which may result in a collision.

This servo parameter does not guarantee the time until network disconnecting. If an error such as an alive error occurs, network disconnecting may be executed before the time that is set in this servo parameter.

- For CC-Link IE Field Network Basic

Set the threshold until [AL. 086.1 Network communication error 1] is detected.

When "0" is set, the detection time is 1000 ms.

[Pr. PN03_Communication mode setting (**NWMD)]

Initial value	Setting range	Setting method	Ver.
00000000h	Refer to the relevant detail No.	Common	Refer to the relevant detail No.

[Pr. PN03.1_CC-Link IE TSN Class setting]

When the command interface of the servo amplifier is EtherCAT or EtherNet/IP, this servo parameter is not available.

Initial value	Setting range	Ver.
0h	Refer to the text	D0

Select a CC-Link IE TSN Class.

0: Class B ver. 1.0/2.0

1: Class A ver. 2.0

[Pr. PN03.3_Object attribute selection]

When the command interface of the servo amplifier is CC-Link IE TSN, this servo parameter is not available.

Initial value	Setting range	Ver.
0h	Refer to the text	D4

Select the attribute of the object.

0: Object attribute selection 1

1: Object attribute selection 2

For servo amplifiers with firmware version D4 or later, the PDO Mapping attribute of the following objects has been changed. To use the PDO Mapping attribute before the change, set "1" in this servo parameter.

Index	Sub Index	Object name	Setting value	
			0 (Object attribute selection 1) (after the change)	1 (Object attribute selection 2) (before the change)
6072h	00h	Max Torque	RxPDO	TxPDO/RxPDO
607Ch	00h	Home Offset	RxPDO	TxPDO
6080h	00h	Max motor speed	RxPDO	TxPDO
608Fh	01h	Encoder increments	RxPDO	TxPDO
608Fh	02h	Motor revolutions	RxPDO	TxPDO

When an ESI file is required for setting this parameter to "1" (Object attribute selection 2), contact your local sales office.

[Pr. PN05_Communication error - Detection frequency setting (CERI)]

When the command interface of the servo amplifier is EtherCAT or EtherNet/IP, this servo parameter is not available.

Initial value	Setting range	Setting method	Ver.
0 [%]	0 to 100	Common	A0

Set the frequency until [AL. 086.5 Network communication error 5] and [AL. 086.6 Network communication error 6] are detected.

The maximum setting range is 100 %.

When "0" is set, the frequency is 8 %.

[Pr. PN06_Function selection N-1 (NOP1)]

Initial value	Setting range	Setting method	Ver.
00000000h	00000000h to 01111000h	Common	Refer to the relevant detail No.

[Pr. PN06.6_Communication error - Alarm detection setting]

When the command interface of the servo amplifier is EtherCAT or EtherNet/IP, this servo parameter is not available.

Initial value	Setting range	Ver.
0h	0h to 1h	E4

The detection of [AL. 086.1 Network communication error 1] in CC-Link IE TSN can be enabled or disabled.

0: Detection of [AL. 086.1 Network communication error 1] is disabled.

1: Detection of [AL. 086.1 Network communication error 1] is enabled.

When the detection is enabled, disconnecting the communication triggers [AL. 086.1 Network communication error 1]. By setting a state other than OP in "NMT State Download" before the disconnection, the communication can be disconnected without detecting the alarm.

[Pr. PN07_Communication cycle initial setting (**CCS)]

When the command interface of the servo amplifier is CC-Link IE TSN or EtherNet/IP, this servo parameter is not available.

Initial value	Setting range	Setting method	Ver
00000000h	Refer to the text	Common	B6

The initial value of the communication cycle in the PDO communication can be set.

Use this servo parameter when [Cycle Time (Obj. 1C32h: 02h)] and [Cycle Time (Obj. 1C33h: 02h)] are not to be set with the master controller (asynchronous mode). This servo parameter setting is not required for master controllers that can change the communication cycle with the objects in the asynchronous mode.

The setting value of this servo parameter will be set in [Cycle Time (Obj. 1C32h: 02h)] and [Cycle Time (Obj. 1C33h: 02h)] as the initial value. Once this servo parameter is set to "0", the objects will be set to "250000 ns (250 μs)". Setting an unsupported communication cycle triggers [AL. 037 Parameter error].

Setting value	Communication cycle
00	Automatic (250 μs)
04	125 μs
05	250 μs
06	500 μs
07	1 ms
08	2 ms
09	4 ms
0A	8 ms

[Pr. PN13_Network protocol setting (**NPS)]

Initial value	Setting range	Setting method	Ver.
0000000h	Refer to the relevant detail No.	Common	Refer to the relevant detail No.

[Pr. PN13.0-3_Network protocol setting]

Initial value		Setting range	Ver.	
J5G	J5G-N1		J5G	J5G-N1
0000h	0100h	Refer to the text	C0	E8

Set the network to be used.

Setting a value other than the following triggers [AL. 037 Parameter error]

Setting value	Setting details
0000h	CC-Link IE TSN
0004h	CC-Link IE Field Network Basic
0100h *1	EtherCAT
0800h	EtherNet/IP

*1 When this servo parameter is set to "0100h", TCP/IP communications cannot be established.

■When the command interface of the servo amplifier is CC-Link IE TSN or CC-Link IE Field Network Basic

This servo parameter is not available for the MR-J5-_G_-LL servo amplifier.

■When the command interface of the servo amplifier is EtherCAT or EtherNet/IP

The MR-J5-_G_-N1 and MR-J5D-_G_-N1 can automatically detect the network using network automatic switching.

When network automatic switching is used, this servo parameter is changed to the value according to the network.

For details on network automatic switching, refer to "How to switch the network protocol" in the User's Manual (Introduction).

[Pr. PN18_Counter level for communication error detection (CERN)]

When the command interface of the servo amplifier is CC-Link IE TSN or EtherNet/IP, this servo parameter is not available.

Initial value	Setting range	Setting method	Ver.
9	0 to 32767	Common	A5

Set the threshold until [AL. 086.1 Network receive data error (Network communication error 1)] is detected.

When "0" is set, this parameter is disabled.

If the PDO data is not updated with Sync0, the internal error counter will be added by 3 at a time.

When the PDO data is updated properly, the internal error counter is subtracted by 1.

Refer to the following for the example of the counter.

Receive (SM2) Event	1	0	1	0	1	0	1	0	1	0	1
Internal Error Counter (Setting value = 9)	0	3	2	5	4	7	6	9 (error)	9	9	9

This servo parameter corresponds to [Sync Error Counter Limit (Obj. 10F1h: 02h)].

If detection of [AL. 086.1] is disabled, the servo motor cannot be stopped at occurrence of a communication error. In addition, if the setting value is increased, it takes longer for the servo motor to stop at occurrence of a communication error. Be careful when changing the set value as there is a danger of collision.

[Pr. PN19_Function selection N-4 (**NOP4)]

When the command interface of the servo amplifier is EtherCAT or EtherNet/IP, this servo parameter is not available.

Initial value	Setting range	Setting method	Ver.
00000000h	Refer to the relevant detail No.	Common	Refer to the relevant detail No.

[Pr. PN19.1_Parameter automatic setting - Forced transmission mode setting]

Initial value	Setting range	Ver.
0h	Refer to the text	E0

This servo parameter can be used only with CC-Link IE TSN.

If this servo parameter is set to "1" (enabled), servo parameters are transmitted when the servo amplifier is connected to a controller whose parameter automatic setting is enabled.

If this servo parameter is set to "1" (enabled), the time until the communication state of the servo amplifier transitions to Pre-Operational depends on the number of axes for which automatic parameter setting is enabled.

0: Disabled

1: Enabled

[Pr. PN20_Parameter automatic backup update interval (**PABI)]

When the command interface of the servo amplifier is EtherCAT or EtherNet/IP, this servo parameter is not available.

Initial value	Setting range	Setting method	Ver.
0	0 to 1000	Common	A5

This servo parameter can be used only with CC-Link IE TSN.

Set the backup interval for a parameter automatic backup to be performed when the specified time passes on an hourly basis.

When the value is set to "0", a parameter automatic backup when the specified time passes is not performed.

When the set backup time is reached while the servo amplifier is not connected to a controller, and the power of the servo amplifier is cycled, even if a connection is established with the controller, backup operation is not immediately performed.

There is a limit to the number of times to write to the data memory of the controller. When the number of connected axes is large and when backup operation is performed at short intervals, the maximum memory writing frequency of the controller may be reached earlier than the operating life.

Therefore, be careful about the frequency of writing when performing a backup.

You can check the frequency of writing so far with the special register in the CPU module.

For details, refer to the CPU module user's manual.

The estimated write interval per number of connected axes is as follows.

1 to 16 axes: Once every hour

17 to 32 axes: Once every two hours

33 to 64 axes: Once every four hours

65 or more axes: Once every six hours

Ex.

When "2" is set for the setting value of this servo parameter

After the power is turned on, whether there is any difference between the previously delivered servo parameter and the current servo parameter is checked every two hours. When there is a difference, backup operation is performed.

[Pr. PN22_Function selection N-5]

When the command interface of the servo amplifier is EtherCAT or EtherNet/IP, this servo parameter is not available.

Initial value	Setting range	Setting method	Ver.
00000000h	Refer to the relevant detail No.	Each axis	Refer to the relevant detail No.

[Pr. PN22.0_Default mapping mode selection]

Initial value	Setting range	Ver.
0h	Refer to the text	C0

This servo parameter can be used only with CC-Link IE Field Network Basic.

Select a default mapping mode to be used with CC-Link IE Field Network Basic.

0: Mode 1

1: Mode 2

2: Mode 3

The setting value "2" can be set on servo amplifiers with firmware version D4 or later.

[Pr. PN33_Device Warning Mask (DWM)]

When the command interface of the servo amplifier is CC-Link IE TSN or EtherNet/IP, this servo parameter is not available.

Initial value	Setting range	Setting method	Ver.
FFFFFFFFh	00000000h to FFFFFFFFh	Each axis	D4

Set the mask values in [Active Device Warning Details (Obj. F381h)] and [Latched Device Warning Details (Obj. F391h)].

This servo parameter corresponds to [Device Warning Mask (Obj. F3A1h)].

For details of the mask values, refer to "[Device Warning Mask (Obj. F3A1h)]" in the following manual.

 MR-J5-G-N1/MR-J5W-G-N1 User's Manual (Object Dictionary)

[Pr. PN34_Device Error Mask (DEM)]

When the command interface of the servo amplifier is CC-Link IE TSN or EtherNet/IP, this servo parameter is not available.

Initial value	Setting range	Setting method	Ver.
FFFFFFFFh	00000000h to FFFFFFFFh	Each axis	D4

Set the mask values in [Active Device Error Details (Obj. F383h)] and [Latched Device Error Details (Obj. F393h)].

This servo parameter corresponds to [Device Error Mask (Obj. F3A3h)].

For details of the mask values, refer to "[Device Error Mask (Obj. F3A3h)]" in the following manual.

 MR-J5-G-N1/MR-J5W-G-N1 User's Manual (Object Dictionary)

1.11 Positioning extension setting servo parameters group ([Pr. PV_ _])

[Pr. PV01_Profile speed command extension setting (PVC2)]

Initial value	Setting range	Setting method	Ver.
0 [Refer to the text below for the unit.]	0 to 4294967295	Each axis	A5

Set the speed command used in the profile position mode (pp) and JOG operation mode (jg).

The unit can be changed to 0.001 mm/s, 0.0001 inch/s, 0.001 degree/s, or pulse/s with [Pr. PT01.2 Unit for position data].

☞ Page 166 [Pr. PT01.2_Unit for position data]

This function is enabled when [Pr. PT01.1 Speed/acceleration/deceleration unit selection] is set to "1". This function and [Pr. PT65 Profile speed command] are mutually exclusive.

The setting value will be clamped at the maximum speed. When changing the speed to the permissible speed, set the speed in [Pr. PA28.4 Speed range limit selection].

This function corresponds to [Profile velocity (Obj. 6081h)].

When an object is mapped in cyclic communication, the controller overwrites the value written with engineering software.

Thus, do not write a value with engineering software.

[Pr. PV03_Maximum profile speed extension setting (MPVCE)]

Initial value	Setting range	Setting method	Ver.
2147483647 [Refer to the text below for the unit.]	0 to 4294967295	Each axis	A5

Set the speed limit value of the profile position mode (pp), the profile velocity mode (pv), and the JOG operation mode (jg).

The unit can be changed to 0.001 mm/s, 0.0001 inch/s, 0.001 degree/s, or pulse/s with [Pr. PT01.2 Unit for position data].

☞ Page 166 [Pr. PT01.2_Unit for position data]

This function is enabled when [Pr. PT01.1 Speed/acceleration/deceleration unit selection] is set to "1". This function and [Pr. PT66 Maximum profile speed] are mutually exclusive.

This function corresponds to [Max profile velocity (Obj. 607Fh)].

When an object is mapped in cyclic communication, the controller overwrites the value written with engineering software.

Thus, do not write a value with engineering software.

[Pr. PV05_Profile acceleration (PACC)]

Initial value	Setting range	Setting method	Ver.
0 [Refer to the text below for the unit.]	0 to 4294967295	Each axis	A5

Set the acceleration used in the profile position mode (pp), the profile velocity mode (pv), and the JOG operation mode (jg).

The unit can be changed to 0.001 mm/s², 0.0001 inch/s², 0.001 degree/s², or pulse/s² with [Pr. PT01.2 Unit for position data].

☞ Page 166 [Pr. PT01.2_Unit for position data]

When the setting value of this servo parameter is "0", the servo motor accelerates in accordance with the time constant set in [Pr. PT49 Speed acceleration time constant].

This function is enabled when [Pr. PT01.1 Speed/acceleration/deceleration unit selection] is set to "1". This function and [Pr. PT49] are mutually exclusive.

This function corresponds to [Profile acceleration (Obj. 6083h)].

When an object is mapped in cyclic communication, the controller overwrites the value written with engineering software.

Thus, do not write a value with engineering software.

[Pr. PV07_Profile deceleration (PDEC)]

Initial value	Setting range	Setting method	Ver.
0 [Refer to the text below for the unit.]	0 to 4294967295	Each axis	A5

Set the deceleration used in the profile position mode (pp), profile velocity mode (pv), and JOG operation mode (jg).

The unit can be changed to 0.001 mm/s², 0.0001 inch/s², 0.001 degree/s², or pulse/s² with [Pr. PT01.2 Unit for position data].

☞ Page 166 [Pr. PT01.2_Unit for position data]

When the setting value of this servo parameter is "0", the servo motor decelerates in accordance with the time constant set in [Pr. PT50 Speed deceleration time constant].

This function is enabled when [Pr. PT01.1] is set to "1". This function and [Pr. PT50] are mutually exclusive.

This function corresponds to [Profile deceleration (Obj. 6084h)].

When an object is mapped in cyclic communication, the controller overwrites the value written with engineering software.

Thus, do not write a value with engineering software.

[Pr. PV09_Deceleration at forced stop (RSBDEC)]

Initial value	Setting range	Setting method	Ver.
0 [Refer to the text below for the unit.]	0 to 4294967295	Each axis	A5

Set the deceleration to be used for the forced stop deceleration function.

The unit can be changed to 0.001 mm/s², 0.0001 inch/s², 0.001 degree/s², or pulse/s² with [Pr. PT01.2 Unit for position data].

☞ Page 166 [Pr. PT01.2_Unit for position data]

When the setting value of this servo parameter is "0", the servo motor decelerates in accordance with the time constant set in [Pr. PC24 Deceleration time constant at forced stop].

This function is enabled when [Pr. PT01.1 Speed/acceleration/deceleration unit selection] is set to "1". This function and [Pr. PC24] are mutually exclusive.

This function corresponds to [Quick stop deceleration (Obj. 6085h)].

When an object is mapped in cyclic communication, the controller overwrites the value written with engineering software.

Thus, do not write a value with engineering software.

[Pr. PV11_Homing speed extension setting (ZRFE)]

Initial value	Setting range	Setting method	Ver.
500000 [Refer to the text below for the unit.]	0 to 4294967295	Each axis	A5

Set the servo motor speed for homing.

The unit can be changed to 0.001 mm/s, 0.0001 inch/s, 0.001 degree/s, or pulse/s with [Pr. PT01.2 Unit for position data].

☞ Page 166 [Pr. PT01.2_Unit for position data]

This function is enabled when [Pr. PT01.1 Speed/acceleration/deceleration unit selection] is set to "1". This function and [Pr. PT05 Homing speed] are mutually exclusive.

The setting value will be clamped at the maximum speed. When changing the speed to the permissible speed, set the speed in [Pr. PA28.4 Speed range limit selection].

This function corresponds to [Speed during search for switch (Obj. 6099h: 01h)].

When an object is mapped in cyclic communication, the controller overwrites the value written with engineering software.

Thus, do not write a value with engineering software.

[Pr. PV13_Creep speed extension setting (CRFE)]

Initial value	Setting range	Setting method	Ver.
100000 [Refer to the text below for the unit.]	0 to 4294967295	Each axis	A5

When performing a homing, set the servo motor speed after proximity dog.

The unit can be changed to 0.001 mm/s, 0.0001 inch/s, 0.001 degree/s, or pulse/s with [Pr. PT01.2 Unit for position data].

☞ Page 166 [Pr. PT01.2_Unit for position data]

This function is enabled when [Pr. PT01.1 Speed/acceleration/deceleration unit selection] is set to "1". This function and [Pr. PT06 Creep speed] are mutually exclusive.

The setting value will be clamped at the maximum speed. When changing the speed to the permissible speed, set the speed in [Pr. PA28.4 Speed range limit selection].

This function corresponds to [Speed during search for zero (Obj. 6099h: 02h)].

When an object is mapped in cyclic communication, the controller overwrites the value written with engineering software.

Thus, do not write a value with engineering software.

[Pr. PV15_Homing acceleration (HMACC)]

Initial value	Setting range	Setting method	Ver.
0 [Refer to the text below for the unit.]	0 to 4294967295	Each axis	A5

Set the acceleration for homing.

The unit can be changed to 0.001 mm/s², 0.0001 inch/s², 0.001 degree/s², or pulse/s² with [Pr. PT01.2 Unit for position data].

☞ Page 166 [Pr. PT01.2_Unit for position data]

When the setting value of this servo parameter is "0", the servo motor accelerates in accordance with the time constant set in [Pr. PT56 Homing acceleration time constant].

This function is enabled when [Pr. PT01.1 Speed/acceleration/deceleration unit selection] is set to "1". This function and [Pr. PT56] are mutually exclusive.

When [Pr. PT55.0 Homing deceleration time constant selection] is set to "0", this function is used as the deceleration for homing.

This function corresponds to [Homing acceleration (Obj. 609Ah)].

When an object is mapped in cyclic communication, the controller overwrites the value written with engineering software.

Thus, do not write a value with engineering software.

[Pr. PV17_Homing deceleration (HMDEC)]

Initial value	Setting range	Setting method	Ver.
0 [Refer to the text below for the unit.]	0 to 4294967295	Each axis	A5

Set the deceleration for homing.

The unit can be changed to 0.001 mm/s², 0.0001 inch/s², 0.001 degree/s², or pulse/s² with [Pr. PT01.2 Unit for position data].

☞ Page 166 [Pr. PT01.2_Unit for position data]

When the setting value of this servo parameter is "0", the servo motor decelerates in accordance with the time constant set in [Pr. PT57 Homing deceleration time constant].

This function is enabled when [Pr. PT01.1 Speed/acceleration/deceleration unit selection] is set to "1". This function and [Pr. PT57] are mutually exclusive.

When "1" is selected for [Pr. PT55.0 Homing deceleration time constant selection], set the deceleration for homing. Selecting "0" in [Pr. PT55.0] will disable the setting value.

[Pr. PV19_Speed reached 2 - Output range - Extension setting (SA2RE)]

Initial value	Setting range	Setting method	Ver.
20000 [Refer to the text below for the unit.]	0 to 65535	Each axis	A5

Set the speed range in which the speed reached 2 turns on in the profile velocity mode (pv).

If the state where the error between the command speed and the servo motor speed is within the setting value of this servo parameter continues for the time set in [Pr. PC73 Speed reached 2 - Output filtering time] or longer, bit 10 (Target velocity reached) of [Statusword (Obj. 6041h)] turns on.

The unit can be changed to 0.001 degrees/s or pulses/s with [Pr. PT01.2 Unit for position data].

☞ Page 166 [Pr. PT01.2_Unit for position data]

This function is enabled when [Pr. PT01.1 Speed/acceleration/deceleration unit selection] is set to "1". This function and [Pr. PC72 Speed reached 2 - Output range] are mutually exclusive.

This function corresponds to [Velocity window (Obj. 606Dh)].

When an object is mapped in cyclic communication, the controller overwrites the value written with engineering software.

Thus, do not write a value with engineering software.

[Pr. PV20_Zero speed 2 level extension setting (ZSP2LE)]

Initial value	Setting range	Setting method	Ver.
20 [Refer to the text below for the unit.]	0 to 65535	Each axis	A5

Set the speed level at which the zero speed 2 turns on in the profile velocity mode (pv).

If the state where the absolute value of the servo motor speed exceeds the setting value of this servo parameter continues for the time set in [Pr. PC66 Zero speed 2 filtering time] or longer, bit 12 (Speed) of [Statusword (Obj. 6041h)] turns off.

The unit can be changed to 0.001 degrees/s or pulses/s with [Pr. PT01.2 Unit for position data].

☞ Page 166 [Pr. PT01.2_Unit for position data]

This function is enabled when [Pr. PT01.1 Speed/acceleration/deceleration unit selection] is set to "1". This function and [Pr. PC65 Zero speed 2 level] are mutually exclusive.

This function corresponds to [Velocity threshold (Obj. 606Fh)].

When an object is mapped in cyclic communication, the controller overwrites the value written with engineering software.

Thus, do not write a value with engineering software.

[Pr. PV21_Speed limit extension setting (VLMTE)]

Initial value	Setting range	Setting method	Ver.
2147483647 [Refer to the text below for the unit.]	0 to 4294967295	Each axis	A5

Set the speed limit value of the cyclic synchronous torque mode (cst), the profile torque mode (tq), and the continuous operation to torque control mode (ct).

The unit can be changed to 0.001 degrees/s or pulses/s with [Pr. PT01.2 Unit for position data].

☞ Page 166 [Pr. PT01.2_Unit for position data]

This function is enabled when [Pr. PT01.1 Speed/acceleration/deceleration unit selection] is set to "1". This function and [Pr. PV67 Speed limit] are mutually exclusive.

This function corresponds to [Velocity limit value (Obj. 2D20h)].

When an object is mapped in cyclic communication, the controller overwrites the value written with engineering software.

Thus, do not write a value with engineering software.

[Pr. PV23_Speed unit conversion - Electronic gear numerator (*VCMX)]

Initial value	Setting range	Setting method	Ver.
1	1 to 1024	Each axis	A5

Set the electric gear numerator for converting the speed (command unit/s) into a value in speed units.
This function is enabled when [Pr. PT01.1 Speed/acceleration/deceleration unit selection] is set to "1".

[Pr. PV24_Speed unit conversion - Electronic gear denominator (*VCDV)]

Initial value	Setting range	Setting method	Ver.
1	1 to 256	Each axis	A5

Set the electric gear denominator for converting the speed command (command unit/s) into a value in speed units.
This function is enabled when [Pr. PT01.1 Speed/acceleration/deceleration unit selection] is set to "1".

[Pr. PV25_Acceleration unit conversion - Electronic gear numerator (*ACMX)]

Initial value	Setting range	Setting method	Ver.
1	1 to 1024	Each axis	A5

Set the electric gear numerator for converting the acceleration (command unit/s²) into a value in acceleration/deceleration units.

This function is enabled when [Pr. PT01.1 Speed/acceleration/deceleration unit selection] is set to "1".

[Pr. PV26_Acceleration range unit conversion - Electronic gear denominator (*ACDV)]

Initial value	Setting range	Setting method	Ver.
1	1 to 256	Each axis	A5

Set the electric gear denominator for converting the acceleration (command unit/s²) into a value in acceleration/deceleration units.

This function is enabled when [Pr. PT01.1 Speed/acceleration/deceleration unit selection] is set to "1".

[Pr. PV29_Acceleration limit (ACCLMT)]

Initial value	Setting range	Setting method	Ver.
0 [Refer to the text below for the unit.]	0 to 4294967295	Each axis	C0

Set the acceleration limit value to be used in the profile position mode (pp), profile velocity mode (pv), homing mode (hm), and JOG operation mode (jg).

The unit can be changed to 0.001 mm/s², 0.0001 inch/s², 0.001 degree/s², or pulse/s² with [Pr. PT01.2 Unit for position data].

 Page 166 [Pr. PT01.2_Unit for position data]

If this servo parameter is set to "0", the acceleration limit is disabled.

This function is enabled when [Pr. PT01.1 Speed/acceleration/deceleration unit selection] is set to "1".

The servo motor accelerates by the setting value of this servo parameter when the following conditions are met:

- The setting value of [Pr. PV05 Profile acceleration] is "0" in pp, pv, or jg mode
- The setting value of [Pr. PV15 Homing acceleration] is "0" in hm mode

This function corresponds to [Max acceleration (Obj. 60C5h)].

When an object is mapped in cyclic communication, the controller overwrites the value written with engineering software.

Thus, do not write a value with engineering software.

[Pr. PV31_Deceleration limit (DECLMT)]

Initial value	Setting range	Setting method	Ver.
0 [Refer to the text below for the unit.]	0 to 4294967295	Each axis	C0

Set the deceleration limit value to be used in the profile position mode (pp), profile velocity mode (pv), homing mode (hm), and JOG operation mode (jg).

The unit can be changed to 0.001 mm/s², 0.0001 inch/s², 0.001 degree/s², or pulse/s² with [Pr. PT01.2 Unit for position data].

 Page 166 [Pr. PT01.2_Unit for position data]

If this servo parameter is set to "0", the deceleration limit is disabled.

This function is enabled when [Pr. PT01.1 Speed/acceleration/deceleration unit selection] is set to "1".

The servo motor decelerates by the setting value of this servo parameter when the following conditions are met:

- The setting value of [Pr. PV07 Profile deceleration] is "0" in pp, pv, or jg mode
- The setting value of [Pr. PV15 Homing acceleration] or [Pr. PV17 Homing deceleration] is "0" in hm mode

This function corresponds to [Max deceleration (Obj. 60C6h)].

When an object is mapped in cyclic communication, the controller overwrites the value written with engineering software.

Thus, do not write a value with engineering software.

[Pr. PV33_Master-slave operation - Speed limit adjusted value extension setting (VLLE)]

When the command interface of the servo amplifier is EtherCAT, this servo parameter is not available.

Initial value	Setting range	Setting method	Ver.
0 [Refer to the text below for the unit.]	0 to 4294967295	Each axis	D0

Set the minimum value of the slave axis speed limit for the slave axis torque mode (slt).

The unit can be changed to pulses/s with [Pr. PT01.2 Unit for position data].

 Page 166 [Pr. PT01.2_Unit for position data]

This servo parameter is enabled only in the slave axis torque mode.

This function is enabled when [Pr. PT01.1 Speed/acceleration/deceleration unit selection] is set to "1". This function and [Pr. PD32 Master-slave operation - Slave-side speed limit adjusted value] are mutually exclusive.

This function corresponds to [Master-slave Lower limit of velocity limit value (Obj. 2E46h)].

When an object is mapped in cyclic communication, the controller overwrites the value written with engineering software.

Thus, do not write a value with engineering software.

This servo parameter is not available for the MR-J5-_G_-LL servo amplifier.

1.12 Extension setting 4 servo parameters group ([Pr. PW_ _])

[Pr. PW01_Pressure control gain (APA)]

Initial value	Setting range	Setting method	Ver.
800	0 to 6000	Each axis	E4

Set the proportional gain of the pressure loop.

When the setting value of this servo parameter is "0", the pressure command is "0".

This servo parameter is available only on the MR-J5-_G_-LL servo amplifier.

[Pr. PW02_Pressure integral compensation (AIA)]

Initial value	Setting range	Setting method	Ver.
75 [ms]	1 to 1000	Each axis	E4

Set the integral time constant of the pressure loop.

This servo parameter is available only on the MR-J5-_G_-LL servo amplifier.

[Pr. PW03_Pressure incomplete integral coefficient (ADA)]

Initial value	Setting range	Setting method	Ver.
10000	0 to 10000	Each axis	E4

Set an incomplete integral coefficient of the pressure loop.

When the setting value of this servo parameter is "10000", the proportional integral control is executed.

When the setting value of this servo parameter is "0", the proportional control is executed.

This servo parameter is available only on the MR-J5-_G_-LL servo amplifier.

[Pr. PW12_Function selection W-1 (*WOP1)]

Initial value	Setting range	Setting method	Ver.
00000000h	Refer to the relevant detail No.	Each axis	Refer to the relevant detail No.

[Pr. PW12.1_Selection of pressure increasing direction for positioning address]

Initial value	Setting range	Ver.
0h	Refer to the text	E4

Select the pressure increasing direction for the increase and decrease of the positioning address.

0: The pressure increases as the positioning address decreases.

1: The pressure increases as the positioning address increases.

The following shows the servo motor rotation direction and pressure increasing direction when this parameter is combined with [Pr. PA14 Travel direction selection].

Setting value		Positioning address increasing direction		Positioning address decreasing direction	
[Pr. PW12.1]	[Pr. PA14]	Pressure	Servo motor rotation direction	Pressure	Servo motor rotation direction
0	0	Decrease	CCW	Increase	CW
	1		CW		CCW
1	0	Increase	CCW	Decrease	CW
	1		CW		CCW

This servo parameter is available only on the MR-J5-_G_-LL servo amplifier.

[Pr. PW12.2_Forward/reverse-side stop function]

Initial value	Setting range	Ver.
0h	Refer to the text	E4

Enable or disable the forward/reverse-side stop function.

Setting value	Forward-side stop	Reverse-side stop
0	Enabled	Enabled
1	Enabled	Disabled
2	Disabled	Disabled

To use the forward/reverse-side stop function, the servo system controller that supports this function is required.

When using a controller together, set [Pr. PW12.2] to "1" or "2". If the mode is switched to the cyclic synchronous pressure mode without setting [Pr. PW12.2] to "1" or "2", [AL. 09E.9 Control mode setting warning] occurs.

If the pressure control axis keeps retracting due to pressure sensor (load cell) errors, set the software stroke limit with the servo system controller. For details, refer to the manual for the servo system controller.

This servo parameter is available only on the MR-J5-_G_-LL servo amplifier.

[Pr. PW13_Function selection W-2 (*WOP2)]

Initial value	Setting range	Setting method	Ver.
00000000h	Refer to the relevant detail No.	Each axis	Refer to the relevant detail No.

[Pr. PW13.0_Pressure control command interpolation]

Initial value	Setting range	Ver.
0h	Refer to the text	E4

Enable or disable the pressure control command interpolation.

0: Disabled (commands from the controller are applied immediately)

1: Enabled (commands from the controller are interpolated before applied)

This servo parameter is available only on the MR-J5-_G_-LL servo amplifier.

[Pr. PW13.1_Speed limit command interpolation]

Initial value	Setting range	Ver.
0h	Refer to the text	E4

Enable or disable the speed limit command interpolation.

0: Disabled (commands from the controller are applied immediately)

1: Enabled (commands from the controller are interpolated before applied)

This servo parameter is available only on the MR-J5-_G_-LL servo amplifier.

[Pr. PW13.4_Control switching method setting]

Initial value	Setting range	Ver.
0h	0h to 2h	E4

0: Disabled

1: Enabled

2: Enabled/disabled with the controller

To reduce the shock caused when the control mode is switched from the cyclic synchronous position mode to the cyclic synchronous pressure mode, set [Modes of operation (Obj. 6060h)] to "1 (enabled)". To use this function, a compatible controller (MR-EM441G) is required. For the controller settings and adjustment, refer to the manual for the controller.

Setting this servo parameter to "1" adds "the command speed is below the speed limit command" to the conditions for switching the control from the cyclic synchronous position mode to the cyclic synchronous pressure mode. If the control mode does not switch to the cyclic synchronous pressure mode even after the time set with [Pr. PW38 Control mode switching waiting time] has elapsed, [AL. 19E.6 Control mode switching waiting warning] occurs.

For details when this servo parameter is set to "0 (disabled)", refer to "Drive profile" in the following manual.

 MR-J5-G/MR-J5W-G User's Manual (Communication Function)

This servo parameter is available only on the MR-J5-_G_-LL servo amplifier.

[Pr. PW20_Pressure control feedback selection (**LDS)]

Initial value	Setting range	Setting method	Ver.
00000000h	Refer to the relevant detail No.	Each axis	Refer to the relevant detail No.

[Pr. PW20.1_Pressure feedback high-speed selection]

Initial value	Setting range	Ver.
0h	Refer to the text	E4

Enable or disable increasing pressure feedback speed.

0: Enabled

1: Disabled (not supported)

When the setting value of this servo parameter is "0 (enabled)", the analog monitor input operates in the one-point mode. AIN0 (pressure feedback) is read at a cycle of 62.5 μ s.

When the setting value of this servo parameter is "1 (disabled)", the analog monitor input operates in the three-point mode. AIN0 (pressure feedback) is read at a cycle of 125 μ s, and AIN1 (analog monitor input 1) and AIN2 (analog monitor input 2) are read at a cycle of 250 μ s.

Setting this servo parameter to "1" triggers [AL. 037 Parameter error].

This servo parameter is available only on the MR-J5-_G_-LL servo amplifier.

[Pr. PW21_Pressure control feedback offset (AFBO)]

Initial value	Setting range	Setting method	Ver.
0 [mV]	-9999 to 9999	Each axis	E4

Set the pressure control feedback offset voltage.

When the setting value of this servo parameter is "100", the pressure control feedback offset voltage is -100 mV.

When the setting value of this servo parameter is "-100", the pressure control feedback offset voltage is +100 mV.

This servo parameter is available only on the MR-J5-_G_-LL servo amplifier.

[Pr. PW22_Pressure control feedback unit constant (AFBD)]

Initial value	Setting range	Setting method	Ver.
20000 [Command unit]	500 to 30000	Each axis	E4

Set the conversion coefficient of the pressure control feedback voltage to be returned to the controller.

Set the pressure control feedback value to be returned to the controller when AIN0 (pressure control feedback) is the maximum input voltage (10 V).

This servo parameter is available only on the MR-J5-_G_-LL servo amplifier.

[Pr. PW23_Analog monitor input 1 offset (AO1)]

Initial value	Setting range	Setting method	Ver.
0 [mV]	-9999 to 9999	Each axis	E4

Set the analog monitor input 1 offset voltage.

When the setting value of this servo parameter is "100", the analog monitor input 1 offset voltage is -100 mV.

When the setting value of this servo parameter is "-100", the analog monitor input 1 offset voltage is +100 mV.

This servo parameter is available only on the MR-J5-_G_-LL servo amplifier.

[Pr. PW24_Analog monitor input 1 unit constant (AIN1)]

Initial value	Setting range	Setting method	Ver.
20000 [Command unit]	500 to 30000	Each axis	E4

Set the conversion coefficient of the analog monitor input 1 voltage to be returned to the controller.

When AIN1 (analog monitor input 1 voltage) is the maximum input voltage (10 V), set the value of the analog monitor input 1 to be returned to the controller.

This servo parameter is available only on the MR-J5-_G_-LL servo amplifier.

[Pr. PW25_Analog monitor input 2 offset (AO2)]

Initial value	Setting range	Setting method	Ver.
0 [mV]	-9999 to 9999	Each axis	E4

Set the analog monitor input 2 offset voltage.

When the setting value of this servo parameter is "100", the analog monitor input 2 offset voltage is -100 mV.

When the setting value of this servo parameter is "-100", the analog monitor input 2 offset voltage is +100 mV.

This servo parameter is available only on the MR-J5-_G_-LL servo amplifier.

[Pr. PW26_Analog monitor input 2 unit constant (AIN2)]

Initial value	Setting range	Setting method	Ver.
20000 [Command unit]	500 to 30000	Each axis	E4

Set the conversion coefficient of the analog monitor input 2 voltage to be returned to the controller.

When AIN2(analog monitor input 2 voltage) is the maximum input voltage (10 V), set the value of the analog monitor input 2 to be returned to the controller.

This servo parameter is available only on the MR-J5-_G_-LL servo amplifier.

[Pr. PW27_Analog monitor input filter setting (ADF)]

Initial value	Setting range	Setting method	Ver.
00000000h	Refer to the relevant detail No.	Each axis	Refer to the relevant detail No.

[Pr. PW27.0_AIN0 (pressure feedback) filter time constant]

Initial value	Setting range	Ver.
0h	Refer to the text	E4

Select the filter time constant of AIN0 (pressure feedback). Refer to the following for the filter time constant.

Setting value	Time constant [ms]
0	No filter
1	0.5
2	1
3	2
4	4
5	8
6	16
7	32
8	64
9	128

This servo parameter is available only on the MR-J5-_G_-LL servo amplifier.

[Pr. PW27.1_AIN1 (analog monitor input 1) filter time constant]

Initial value	Setting range	Ver.
0h	Refer to the text	E4

Select the filter time constant of AIN1 (analog monitor input 1).

Refer to the following for setting values.

☞ Page 204 [Pr. PW27.0_AIN0 (pressure feedback) filter time constant]

This servo parameter is available only on the MR-J5-_G_-LL servo amplifier.

[Pr. PW27.2_AIN2 (analog monitor input 2) filter time constant]

Initial value	Setting range	Ver.
0h	Refer to the text	E4

Select the filter time constant of AIN2 (analog monitor input 2).

Refer to the following for setting values.

☞ Page 204 [Pr. PW27.0_AIN0 (pressure feedback) filter time constant]

This servo parameter is available only on the MR-J5-_G_-LL servo amplifier.

[Pr. PW33_Pressure control moving average filter setting (*MAF)]

Initial value	Setting range	Setting method	Ver.
00000000h	Refer to the relevant detail No.	Each axis	Refer to the relevant detail No.

[Pr. PW33.0_AIN0 (pressure feedback) moving average filter time setting]

Initial value	Setting range	Ver.
0h	Refer to the text	E4

Select the moving average filter time setting for AIN0 (pressure feedback).

Setting value	Filter time setting
0	Automatic setting (1.000 ms)
1	No filter
2	0.125 ms
3	0.250 ms
4	0.500 ms
5	1.000 ms
6	2.000 ms
7	4.000 ms

This servo parameter is available only on the MR-J5-_G_-LL servo amplifier.

[Pr. PW33.1_AIN1 (analog monitor input 1) moving average filter time setting]

Initial value	Setting range	Ver.
0h	Refer to the text	E4

Select the moving average filter time setting for AIN1 (analog monitor input 1).

Setting value	Filter time setting
0	Automatic setting (2.000 ms)
1	No filter
2	0.500 ms
3	1.000 ms
4	2.000 ms
5	4.000 ms

This servo parameter is available only on the MR-J5-_G_-LL servo amplifier.

[Pr. PW33.2_AIN2 (analog monitor input 2) moving average filter time setting]

Initial value	Setting range	Ver.
0h	Refer to the text	E4

Select the moving average filter time setting for AIN2 (analog monitor input 2).

Refer to the following for setting values.

☞ Page 205 [Pr. PW33.1_AIN1 (analog monitor input 1) moving average filter time setting]

This servo parameter is available only on the MR-J5-_G_-LL servo amplifier.

[Pr. PW34_Function selection W-5 (*WOP5)]

Initial value	Setting range	Setting method	Ver.
00000000h	Refer to the relevant detail No.	Each axis	Refer to the relevant detail No.

[Pr. PW34.0_Pressure model adaptive control selection]

Initial value	Setting range	Ver.
0h	Refer to the text	E4

Enable or disable the pressure model adaptive control.

This parameter can be set for the combination of the processes of the pressure control. For details on each process of the pressure control, refer to the manual for the servo system controller.

Set this servo parameter to improve the response of the pressure control.

Setting value	Each process of pressure control	
	Dwell operation	Pressure release operation
0	Disabled	Disabled
1	Enabled	Disabled
2	Disabled	Enabled
3	Enabled	Enabled

When setting this servo parameter to a value other than "0", set [Pr. PW03 Pressure incomplete integral coefficient] to "0" to execute the proportional control.

This servo parameter is available only on the MR-J5-_G_-LL servo amplifier.

[Pr. PW35_Pressure model control gain (AMPA)]

Initial value	Setting range	Setting method	Ver.
20	1 to 36000	Each axis	E4

Set the response gain for the pressure command.

Increasing the setting value of this servo parameter improves responsiveness to the pressure command, but increasing the value too much raises the likelihood of an overshoot of the pressure feedback.

When [Pr. PW34.0 Pressure model adaptive control selection] is set to a value other than "0" (disabled), the setting value of this servo parameter is enabled.

This servo parameter is available only on the MR-J5-_G_-LL servo amplifier.

[Pr. PW36_Pressure model control coefficient (AMCEF)]

Initial value	Setting range	Setting method	Ver.
100000	1 to 4294967295	Each axis	E4

Set the pressure model control coefficient.

For the setting method, refer to "Servo parameter adjustment method" in User's Manual (Adjustment).

When [Pr. PW34.0 Pressure model adaptive control selection] is set to a value other than "0" (disabled), the setting value of this servo parameter is enabled.

This servo parameter is available only on the MR-J5-_G_-LL servo amplifier.

[Pr. PW38_Control mode switching waiting time (MOPWT)]

Initial value	Setting range	Setting method	Ver.
1 [100 ms]	1 to 100	Each axis	E4

Set the detection time for [AL. 19E.6 Control mode switching waiting warning].

Refer to the following for setting values.

☞ Page 201 [Pr. PW13.4_Control switching method setting]

This servo parameter is available only on the MR-J5-_G_-LL servo amplifier.

2 LISTS OF SERVO PARAMETER SUPPORTED MODES

2.1 Structure

The following shows the meaning of each abbreviation used in the lists. "○" indicates the modes that can be used, and "—" indicates the modes that cannot be used or modes that are not used even if set.

Mode	List abbreviation	Meaning
Operation mode	Standard	Standard control mode
	Linear	Linear servo motor control mode
	DD	Direct drive motor control mode
	Semi closed	Semi closed loop control mode
	Fully closed	Fully closed loop control mode
Control mode	csp	Cyclic synchronous position mode
	csv	Cyclic synchronous velocity mode
	cst	Cyclic synchronous torque mode
	pp	Profile position mode
	pv	Profile velocity mode
	tq	Profile torque mode
	hm	Homing mode
	pt	Point table mode
	jg	JOG operation mode
	ct	Continuous operation to torque control mode
	slt	Slave axis torque mode
	cspr	Cyclic synchronous pressure mode

2.2 Lists of supported control modes

Basic setting servo parameters group ([Pr. PA_ _])

No.	Detail No.	Operation mode					Control mode											
		Semi closed			Fully closed		csp	csv	cst	pp	pv	tq	hm	pt	jg	ct	slt	csp _r
		Standard	Linear	DD	Standard	DD												
PA01	PA01.0	○	○	○	○	○	○	○	○	○	○	○	○	○	○	○	○	○
	PA01.1	○	○	○	○	○	○	○	○	○	○	○	○	○	○	○	○	○
	PA01.4	○	—	○	○	○	○	○	○	○	○	○	○	○	○	○	○	—
	PA01.7	○	○	○	—	—	○	○	○	—	—	—	○	—	—	○	○	—
PA02	PA02.0-1	○	○	○	○	○	○	○	○	○	○	○	○	○	○	○	○	○
	PA02.4	○	○	○	○	○	○	○	○	○	○	○	○	○	○	○	○	○
	PA02.5	○	○	○	○	○	○	○	○	○	○	○	○	○	○	○	○	○
PA03	PA03.0	○	○	○	○	○	○	○	○	○	○	○	○	○	○	○	○	○
	PA03.1	○	—	—	○	—	○	○	○	○	○	○	○	○	○	○	○	○
	PA03.2	○	—	—	—	—	○	○	○	○	○	○	○	○	○	○	○	—
PA04	PA04.2	○	○	○	○	○	○	○	○	○	○	○	○	○	○	○	○	○
	PA04.3	○	○	○	○	○	○	○	—	○	○	—	○	○	○	—	—	○
PA06	—	○	○	○	○	○	○	○	○	○	○	○	○	○	○	○	○	○
PA07	—	○	○	○	○	○	○	○	○	○	○	○	○	○	○	○	○	○
PA08	PA08.0	○	○	○	○	○	○	○	—	○	○	—	○	○	○	—	—	—
	PA08.4	○	○	○	○	○	○	○	—	○	○	—	○	○	○	—	—	—
	PA08.5	○	○	○	○	○	○	○	—	○	○	—	○	○	○	—	—	—
	PA08.6	○	○	○	○	○	○	○	—	○	○	—	○	○	○	—	—	—
PA09	—	○	○	○	○	○	○	○	—	○	○	—	○	○	○	○	—	—
PA10	—	○	○	○	○	○	○	—	—	○	—	—	○	○	○	—	—	—
PA11	—	○	○	○	○	○	○	○	○	○	○	○	○	○	○	○	○	○
PA12	—	○	○	○	○	○	○	○	○	○	○	○	○	○	○	○	○	○
PA14	—	○	○	○	○	○	○	○	○	○	○	○	○	○	○	○	○	○
PA15	—	○	○	○	○	○	○	○	○	○	○	○	○	○	○	○	○	—
PA16	—	○	○	○	○	○	○	○	○	○	○	○	○	○	○	○	○	—
PA17	—	—	○	○	—	○	○	○	○	○	○	○	○	○	○	○	—	○
PA18	PA18.0-3	—	○	○	—	○	○	○	○	○	○	○	○	○	○	○	—	○
PA19	—	○	○	○	○	○	○	○	○	○	○	○	○	○	○	○	○	○
PA20	PA20.1	○	○	○	○	○	○	○	—	○	○	—	○	○	○	○	○	—
	PA20.2	○	○	○	○	○	○	○	○	○	○	○	○	○	○	○	○	○
PA21	PA21.0	○	○	○	○	○	○	○	—	○	○	—	○	○	○	—	—	—
PA22	PA22.1	○	○	○	○	○	○	—	—	○	—	—	○	○	○	—	—	—
	PA22.3	○	○	○	—	—	○	○	○	○	○	○	○	○	○	○	○	—
PA23	PA23.0-1	○	○	○	○	○	○	○	○	○	○	○	○	○	○	○	○	○
	PA23.2-4	○	○	○	○	○	○	○	○	○	○	○	○	○	○	○	○	○
PA24	PA24.0	○	○	○	○	○	○	○	—	○	○	—	○	○	○	—	—	—
	PA24.5	○	○	○	○	○	○	○	—	○	○	—	○	○	○	—	—	—
PA25	—	○	○	○	○	○	○	—	—	○	—	—	○	○	○	—	—	—
PA26	PA26.0	○	○	○	○	○	○	○	—	○	○	—	○	○	○	○	—	—
PA28	PA28.4	○	○	○	○	○	○	○	○	○	○	○	○	○	○	○	○	○
PA34	—	○	○	○	○	○	○	○	○	○	○	○	○	○	○	—	○	—

Gain/filter setting servo parameters group ([Pr. PB_ _])

No.	Detail No.	Operation mode					Control mode											
		Semi closed			Fully closed		csp	csv	cst	pp	pv	tq	hm	pt	jg	ct	slt	cspr
		Standard	Linear	DD	Standard	DD												
PB01	PB01.0	○	○	○	○	○	○	○	○	○	○	○	○	○	○	○	○	—
	PB01.3	○	○	○	○	○	○	○	—	○	○	—	○	○	○	○	—	—
PB02	PB02.0	○	○	○	○	○	○	—	—	○	—	—	○	○	○	—	—	—
	PB02.1	○	○	○	○	○	○	—	—	○	—	—	○	○	○	—	—	—
PB03	—	○	○	○	○	○	—	—	—	—	—	—	—	—	○	—	—	—
PB04	—	○	○	○	○	○	○	—	—	○	—	—	○	○	○	—	—	—
PB06	—	○	○	○	○	○	○	○	—	○	○	—	○	○	○	○	—	○
PB07	—	○	○	○	○	○	○	○	—	○	○	—	○	○	○	—	—	○
PB08	—	○	○	○	○	○	○	—	—	○	—	—	○	○	○	—	—	—
PB09	—	○	○	○	○	○	○	○	—	○	○	—	○	○	○	○	—	○
PB10	—	○	○	○	○	○	○	○	—	○	○	—	○	○	○	○	—	○
PB11	—	○	○	○	○	○	○	○	—	○	○	—	○	○	○	○	—	—
PB12	—	○	○	○	○	○	○	—	—	○	—	—	○	○	○	—	—	—
PB13	—	○	○	○	○	○	○	○	○	○	○	○	○	○	○	○	○	○
PB14	PB14.1	○	○	○	○	○	○	○	○	○	○	○	○	○	○	○	○	○
	PB14.2	○	○	○	○	○	○	○	○	○	○	○	○	○	○	○	○	○
PB15	—	○	○	○	○	○	○	○	○	○	○	○	○	○	○	○	○	○
PB16	PB16.0	○	○	○	○	○	○	○	○	○	○	○	○	○	○	○	○	○
	PB16.1	○	○	○	○	○	○	○	○	○	○	○	○	○	○	○	○	○
	PB16.2	○	○	○	○	○	○	○	○	○	○	○	○	○	○	○	○	○
PB17	PB17.0-1	○	○	○	○	○	○	○	○	○	○	○	○	○	○	○	○	○
	PB17.2	○	○	○	○	○	○	○	○	○	○	○	○	○	○	○	○	○
PB18	—	○	○	○	○	○	○	○	—	○	○	—	○	○	○	○	—	○
PB19	—	○	○	○	○	○	○	—	—	○	—	—	○	○	○	—	—	—
PB20	—	○	○	○	○	○	○	—	—	○	—	—	○	○	○	—	—	—
PB21	—	○	○	○	○	○	○	—	—	○	—	—	○	○	○	—	—	—
PB22	—	○	○	○	○	○	○	—	—	○	—	—	○	○	○	—	—	—
PB23	PB23.0	○	○	○	○	○	○	○	○	○	○	○	○	○	○	○	○	○
	PB23.1	○	○	○	○	○	○	○	—	○	○	—	○	○	○	○	—	○
	PB23.3	○	○	○	○	○	○	○	○	○	○	○	○	○	○	○	○	○
PB24	PB24.0	○	○	○	○	○	○	—	—	○	—	—	○	○	○	—	—	—
	PB24.1	○	○	○	○	○	○	—	—	○	—	—	○	○	○	—	—	—
PB25	PB25.0	○	○	○	○	○	○	○	—	○	○	—	○	○	○	—	—	—
PB26	PB26.0	○	○	○	○	○	○	○	—	○	○	—	○	○	○	○	—	○
	PB26.1	○	○	○	○	○	○	○	—	○	○	—	○	○	○	○	—	○
	PB26.2	○	○	○	○	○	○	○	—	○	○	—	○	○	○	○	—	○
	PB26.4	○	○	○	○	○	○	○	—	○	○	—	○	○	○	○	—	○
	PB26.5	○	○	○	○	○	○	—	—	○	—	—	○	○	○	—	—	—
PB27	—	○	○	○	○	○	○	○	—	○	○	—	○	○	○	○	—	○
PB28	—	○	○	○	○	○	○	○	—	○	○	—	○	○	○	○	—	○
PB29	—	○	○	○	○	○	○	○	—	○	○	—	○	○	○	○	—	○
PB30	—	○	○	○	○	○	○	—	—	○	—	—	○	○	○	○	—	—
PB31	—	○	○	○	○	○	○	○	—	○	○	—	○	○	○	○	—	○
PB32	—	○	○	○	○	○	○	○	—	○	○	—	○	○	○	○	—	○
PB33	—	○	○	○	○	○	○	—	—	○	—	—	○	○	○	—	—	—
PB34	—	○	○	○	○	○	○	—	—	○	—	—	○	○	○	—	—	—
PB35	—	○	○	○	○	○	○	—	—	○	—	—	○	○	○	—	—	—
PB36	—	○	○	○	○	○	○	—	—	○	—	—	○	○	○	—	—	—

No.	Detail No.	Operation mode					Control mode											
		Semi closed			Fully closed		csp	csv	cst	pp	pv	tq	hm	pt	jg	ct	slt	cspr
		Standard	Linear	DD	Standard	DD												
PB45	PB45.0-1	○	○	○	○	○	○	—	—	○	—	—	○	○	—	—	—	
	PB45.2	○	○	○	○	○	○	—	—	○	—	—	○	○	—	—	—	
PB46	—	○	○	○	○	○	○	○	○	○	○	○	○	○	○	○	○	
PB47	PB47.0	○	○	○	○	○	○	○	○	○	○	○	○	○	○	○	○	
	PB47.1	○	○	○	○	○	○	○	○	○	○	○	○	○	○	○	○	
	PB47.2	○	○	○	○	○	○	○	○	○	○	○	○	○	○	○	○	
PB48	—	○	○	○	○	○	○	○	○	○	○	○	○	○	○	○	○	
PB49	PB49.0	○	○	○	○	○	○	○	○	○	○	○	○	○	○	○	○	
	PB49.1	○	○	○	○	○	○	○	○	○	○	○	○	○	○	○	○	
	PB49.2	○	○	○	○	○	○	○	○	○	○	○	○	○	○	○	○	
PB50	—	○	○	○	○	○	○	○	○	○	○	○	○	○	○	○	○	
PB51	PB51.0	○	○	○	○	○	○	○	○	○	○	○	○	○	○	○	○	
	PB51.1	○	○	○	○	○	○	○	○	○	○	○	○	○	○	○	○	
	PB51.2	○	○	○	○	○	○	○	○	○	○	○	○	○	○	○	○	
PB52	—	○	○	○	○	○	○	—	—	○	—	—	○	○	—	—	—	
PB53	—	○	○	○	○	○	○	—	—	○	—	—	○	○	—	—	—	
PB54	—	○	○	○	○	○	○	—	—	○	—	—	○	○	—	—	—	
PB55	—	○	○	○	○	○	○	—	—	○	—	—	○	○	—	—	—	
PB56	—	○	○	○	○	○	○	—	—	○	—	—	○	○	—	—	—	
PB57	—	○	○	○	○	○	○	—	—	○	—	—	○	○	—	—	—	
PB58	—	○	○	○	○	○	○	—	—	○	—	—	○	○	—	—	—	
PB59	—	○	○	○	○	○	○	—	—	○	—	—	○	○	—	—	—	
PB60	—	○	○	○	○	○	○	○	—	○	○	—	○	○	—	—	○	
PB65	—	○	○	○	○	○	○	○	—	○	○	—	○	○	○	—	○	
PB66	—	○	○	○	○	○	○	○	—	○	○	—	○	○	○	—	○	
PB67	—	○	○	○	○	○	○	○	—	○	○	—	○	○	○	—	○	
PB68	—	○	○	○	○	○	○	—	—	○	—	—	○	○	○	—	—	
PB69	—	○	○	○	○	○	○	○	—	○	○	—	○	○	○	—	○	
PB70	—	○	○	○	○	○	○	○	—	○	○	—	○	○	○	—	○	
PB71	—	○	○	○	○	○	○	—	—	○	—	—	○	○	—	—	—	
PB72	—	○	○	○	○	○	○	—	—	○	—	—	○	○	—	—	—	
PB73	—	○	○	○	○	○	○	—	—	○	—	—	○	○	—	—	—	
PB74	—	○	○	○	○	○	○	—	—	○	—	—	○	○	—	—	—	
PB75	—	○	○	○	○	○	○	—	—	○	—	—	○	○	—	—	—	
PB76	—	○	○	○	○	○	○	—	—	○	—	—	○	○	—	—	—	
PB77	—	○	○	○	○	○	○	—	—	○	—	—	○	○	—	—	—	
PB78	—	○	○	○	○	○	○	—	—	○	—	—	○	○	—	—	—	
PB79	—	○	○	○	○	○	○	○	—	○	○	—	○	○	—	—	○	
PB81	PB81.4	○	○	○	○	○	○	—	—	○	—	—	○	○	—	—	—	
PB82	—	○	○	○	○	○	○	—	—	○	—	—	○	○	—	—	—	

Extension setting servo parameters group ([Pr. PC_ _])

No.	Detail No.	Operation mode					Control mode											
		Semi closed			Fully closed		csp	csv	cst	pp	pv	tq	hm	pt	jg	ct	slt	cspr
		Standard	Linear	DD	Standard	DD												
PC01	—	○	○	○	○	○	○	—	—	○	—	—	○	○	○	—	—	—
PC02	—	○	○	○	○	○	○	○	○	○	○	○	○	○	○	○	○	○
PC03	PC03.0	○	○	○	○	○	○	○	○	○	○	○	○	○	○	○	○	—
	PC03.1	○	○	○	○	○	○	○	○	○	○	○	○	○	○	○	○	—
	PC03.2	○	○	○	○	○	○	○	○	○	○	○	○	○	○	○	○	—
PC04	PC04.3	○	○	○	○	○	○	○	○	○	○	○	○	○	○	○	○	○
PC05	PC05.0	○	—	—	—	—	○	○	○	○	○	○	○	○	○	○	○	—
	PC05.4	○	○	○	○	○	○	○	○	○	○	○	○	○	○	○	○	○
PC06	PC06.0	○	○	○	○	○	○	—	—	○	—	—	○	○	○	—	—	—
	PC06.3	○	○	○	○	○	○	—	—	○	—	—	○	○	○	—	—	—
PC07	—	○	○	○	○	○	○	○	○	○	○	○	○	○	○	○	○	○
PC08	—	○	○	○	○	○	○	○	○	○	○	○	○	○	○	○	○	○
PC09	PC09.0-1	○	○	○	○	○	○	○	○	○	○	○	○	○	○	○	○	○
	PC09.3	○	○	○	○	○	○	○	○	○	○	○	○	○	○	○	○	○
PC10	PC10.0-1	○	○	○	○	○	○	○	○	○	○	○	○	○	○	○	○	○
	PC10.3	○	○	○	○	○	○	○	○	○	○	○	○	○	○	○	○	○
PC11	—	○	○	○	○	○	○	○	○	○	○	○	○	○	○	○	○	○
PC12	—	○	○	○	○	○	○	○	○	○	○	○	○	○	○	○	○	○
PC16	PC16.4	○	○	○	○	○	○	○	○	○	○	○	○	○	○	○	○	○
	PC16.5	○	○	○	○	○	○	○	○	○	○	○	○	○	○	○	○	○
PC17	PC17.1	—	○	—	—	—	○	○	○	○	○	○	○	○	○	○	○	○
PC19	PC19.0	○	○	○	○	○	○	○	—	○	○	—	○	○	○	—	—	○
	PC19.4	○	○	○	○	○	○	○	○	○	○	○	○	○	○	○	○	○
	PC19.6	○	○	○	○	○	○	○	○	○	○	○	○	○	○	○	○	○
PC20	PC20.2	○	○	○	○	○	○	○	○	○	○	○	○	○	○	○	○	○
	PC20.4	○	○	○	○	○	○	○	○	○	○	○	○	○	○	○	○	○
	PC20.6	○	○	○	○	○	○	○	○	○	○	○	○	○	○	○	○	○
PC21	PC21.0	○	○	○	○	○	○	○	○	○	○	○	○	○	○	○	○	○
PC24	—	○	○	○	○	○	○	○	—	○	○	—	○	○	○	—	—	—
PC26	PC26.3	○	○	○	○	○	○	○	○	○	○	○	○	○	○	○	○	—
PC27	PC27.0	○	○	○	○	○	○	○	○	○	○	○	○	○	○	○	○	○
	PC27.2	○	○	○	○	○	○	○	○	○	○	○	○	○	○	○	○	—
	PC27.5	○	○	○	—	—	○	○	○	○	○	○	○	○	○	○	○	—
	PC27.6	—	○	—	—	—	○	○	○	○	○	○	○	○	○	—	○	○
PC29	PC29.0	○	—	—	○	—	○	○	○	○	○	○	○	○	○	○	○	○
	PC29.3	○	○	○	○	○	○	○	○	○	○	○	○	○	○	○	○	○
	PC29.5	○	—	○	○	○	○	○	○	○	○	○	○	○	○	○	○	○
PC31	—	○	○	○	○	○	○	—	—	○	—	—	○	○	○	—	—	
PC38	—	○	○	○	○	○	○	—	—	○	—	—	○	○	○	—	—	
PC41	PC41.0	○	○	○	○	○	○	—	—	—	—	—	—	—	—	—	—	—
	PC41.3	○	○	○	○	○	○	○	○	○	○	○	○	○	○	○	○	○
PC42	PC42.0	○	○	○	○	○	○	○	○	○	○	○	○	○	○	○	○	○
PC43	—	○	○	○	○	○	○	○	○	○	○	○	○	○	○	○	○	○
PC44	—	○	○	○	○	○	○	○	○	○	○	○	○	○	○	○	○	○
PC46	PC46.1	○	○	○	○	○	○	○	○	○	○	○	○	○	○	○	○	○
	PC46.2	○	○	○	○	○	○	○	○	○	○	○	○	○	○	○	○	○
	PC46.3	○	○	○	○	○	○	○	○	○	○	○	○	○	○	○	○	○
PC65	—	○	○	○	○	○	—	—	—	—	○	—	—	—	—	—	—	

No.	Detail No.	Operation mode					Control mode											
		Semi closed			Fully closed		csp	csv	cst	pp	pv	tq	hm	pt	jg	ct	slt	cspr
		Standard	Linear	DD	Standard	DD												
PC66	—	○	○	○	○	○	—	—	—	—	○	—	—	—	—	—	—	—
PC67	—	○	○	○	○	○	○	—	—	○	—	—	—	○	○	—	—	—
PC69	—	○	○	○	○	○	○	—	—	○	—	—	—	○	○	—	—	—
PC70	—	○	○	○	○	○	—	—	—	○	—	—	—	○	○	—	—	—
PC71	—	○	○	○	○	○	—	—	—	○	—	—	—	○	○	—	—	—
PC72	—	○	○	○	○	○	—	—	—	—	○	—	—	—	—	—	—	—
PC73	—	○	○	○	○	○	—	—	—	—	○	—	—	—	—	—	—	—
PC76	PC76.1	○	○	○	○	○	○	○	○	○	○	○	○	○	○	○	○	○
	PC76.2	○	○	○	○	○	○	○	○	○	○	○	○	○	○	○	○	○
	PC76.3	○	○	○	○	○	○	○	○	○	○	○	○	○	○	○	○	○
PC78	PC78.1	○	○	○	○	○	○	○	○	○	○	○	○	○	○	○	○	○
PC79	PC79.0-1	○	○	○	○	○	○	○	○	○	○	○	○	○	○	○	○	○
PC96	—	○	—	—	○	○	○	○	○	○	○	○	○	○	○	○	○	○

I/O setting servo parameters group ([Pr. PD_ _])

No.	Detail No.	Operation mode					Control mode											
		Semi closed			Fully closed		csp	csv	cst	pp	pv	tq	hm	pt	jg	ct	slt	cspr
		Standard	Linear	DD	Standard	DD												
PD01	PD01.0-7	○	○	○	○	○	○	○	○	○	○	○	○	○	○	○	○	○
PD03	PD03.0-1	○	○	○	○	○	○	○	○	○	○	○	○	○	○	○	○	○
PD04	PD04.0-1	○	○	○	○	○	○	○	○	○	○	○	○	○	○	○	○	○
PD05	PD05.0-1	○	○	○	○	○	○	○	○	○	○	○	○	○	○	○	○	○
	PD05.4	○	○	○	○	○	○	○	○	○	○	○	○	○	○	○	○	○
PD07	PD07.0-1	○	○	○	○	○	○	○	○	○	○	○	○	○	○	○	○	○
PD08	PD08.0-1	○	○	○	○	○	○	○	○	○	○	○	○	○	○	○	○	○
	PD08.2	○	○	○	○	○	○	○	○	○	○	○	○	○	○	○	○	○
	PD08.3	○	○	○	○	○	○	○	○	○	○	○	○	○	○	○	○	○
PD09	PD09.0-1	○	○	○	○	○	○	○	○	○	○	○	○	○	○	○	○	○
	PD09.2	○	○	○	○	○	○	○	○	○	○	○	○	○	○	○	○	○
	PD09.3	○	○	○	○	○	○	○	○	○	○	○	○	○	○	○	○	○
PD11	PD11.0	○	○	○	○	○	○	○	○	○	○	○	○	○	○	○	○	
PD12	PD12.3	○	○	○	○	○	○	○	○	○	○	○	○	○	○	○	○	○
PD13	PD13.2	○	○	○	○	○	○	—	—	○	—	—	○	○	○	—	—	—
PD14	PD14.1	○	○	○	○	○	○	○	○	○	○	○	○	○	○	○	○	○
PD15	PD15.0	○	—	—	○	—	○	○	○	○	○	○	○	○	○	○	○	—
	PD15.1	○	—	—	—	—	—	—	—	—	—	—	—	—	—	—	○	—
PD22	—	○	—	—	—	—	—	—	—	—	—	—	—	—	—	—	○	—
PD23	PD23.1	○	—	—	—	—	—	—	—	—	—	—	—	—	—	—	○	—
PD26	PD26.0	○	—	—	—	—	—	—	—	—	—	—	—	—	—	—	○	—
	PD26.1	○	—	—	—	—	—	—	—	—	—	—	—	—	—	—	○	—
PD30	—	○	—	—	—	—	—	—	—	—	—	—	—	—	—	—	○	—
PD31	—	○	—	—	—	—	—	—	—	—	—	—	—	—	—	—	○	—
PD32	—	○	—	—	—	—	—	—	—	—	—	—	—	—	—	—	○	—
PD38	PD38.0-1	○	○	○	○	○	○	○	○	○	○	○	○	○	○	○	○	○
PD39	PD39.0-1	○	○	○	○	○	○	○	○	○	○	○	○	○	○	○	○	○
PD41	PD41.2	○	○	○	○	○	○	○	○	○	○	○	○	○	○	—	○	○
	PD41.3	○	○	○	○	○	○	○	○	○	○	○	○	○	○	—	○	○
PD51	PD51.0-1	○	○	○	○	○	○	○	○	○	○	○	○	○	○	○	○	○
	PD51.4	○	○	○	○	○	○	○	○	○	○	○	○	○	○	○	○	○
PD60	PD60.0-7	○	○	○	○	○	○	○	○	○	○	○	○	○	○	○	○	○
PD61	PD61.2	○	○	○	○	○	○	○	○	○	○	○	○	○	○	○	○	○

Extension setting 2 servo parameters group ([Pr. PE_ _])

No.	Detail No.	Operation mode					Control mode											
		Semi closed			Fully closed		csp	csv	cst	pp	pv	tq	hm	pt	jg	ct	slt	cspr
		Standard	Linear	DD	Standard	DD												
PE01	PE01.0	—	—	—	○	○	○	○	○	—	—	—	—	—	—	—	○	—
	PE01.4	—	—	—	○	○	○	○	○	—	—	—	—	—	—	—	○	—
PE03	PE03.0	—	—	—	○	○	○	—	—	○	—	—	○	○	○	—	—	—
	PE03.1	—	—	—	○	○	○	—	—	○	—	—	○	○	○	—	—	—
	PE03.3	—	—	—	○	○	○	—	—	○	—	—	○	○	○	—	—	—
PE04	—	—	—	—	○	○	○	—	—	○	—	—	○	○	○	—	—	—
PE05	—	—	—	—	○	○	○	—	—	○	—	—	○	○	○	—	—	—
PE06	—	—	—	—	○	○	○	○	○	○	○	○	○	○	○	○	○	—
PE07	—	—	—	—	○	○	○	○	○	○	○	○	○	○	○	○	○	—
PE08	—	—	—	—	○	○	○	—	—	○	—	—	○	○	○	—	—	—
PE10	PE10.1	—	—	—	○	○	○	○	○	○	○	○	○	○	○	○	○	—
PE41	PE41.0	○	○	○	○	○	○	○	○	○	○	○	○	○	○	○	○	○
	PE41.6	○	○	○	○	○	○	○	○	○	○	○	○	○	○	○	○	○
PE44	—	○	○	○	○	○	○	—	—	○	—	—	○	○	○	—	—	—
PE45	—	○	○	○	○	○	○	—	—	○	—	—	○	○	○	—	—	—
PE46	—	○	○	○	○	○	○	—	—	○	—	—	○	○	○	—	—	—
PE47	—	○	○	○	○	○	○	○	○	○	○	○	○	○	○	○	○	○
PE48	PE48.0	○	○	○	○	○	○	—	—	○	—	—	○	○	○	—	—	—
	PE48.1	○	○	○	○	○	○	—	—	○	—	—	○	○	○	—	—	—
PE49	—	○	○	○	○	○	○	—	—	○	—	—	○	○	○	—	—	—
PE50	—	○	○	○	○	○	○	—	—	○	—	—	○	○	○	—	—	—
PE51	—	○	○	○	○	○	○	○	○	○	○	○	○	○	○	○	○	—
PE53	—	○	○	○	○	○	○	○	○	○	○	○	○	○	○	○	○	○

Extension setting 3 servo parameters group ([Pr. PF_ _])

No.	Detail No.	Operation mode					Control mode											
		Semi closed			Fully closed		csp	csv	cst	pp	pv	tq	hm	pt	jg	ct	slt	cspr
		Standard	Linear	DD	Standard	DD												
PF02	PF02.0	○	○	○	○	○	○	○	○	○	○	○	○	○	○	○	○	—
	PF02.4	○	○	○	○	○	○	○	○	○	○	○	○	○	○	○	○	○
	PF02.5	○	○	○	○	○	○	○	○	○	○	○	○	○	○	○	○	○
PF06	PF06.0	○	—	—	○	—	○	○	○	○	○	○	○	○	○	○	○	○
	PF06.1	○	○	○	○	○	○	○	○	○	○	○	○	○	○	○	○	○
PF12	—	○	—	—	○	—	○	○	○	○	○	○	○	○	○	○	○	○
PF18	—	○	○	○	○	○	○	○	○	○	○	○	○	○	○	○	○	○
PF19	—	○	○	○	○	○	○	○	○	○	○	○	○	○	○	○	○	—
PF20	—	○	○	○	○	○	○	○	○	○	○	○	○	○	○	○	○	—
PF21	—	○	○	○	○	○	○	○	○	○	○	○	○	○	○	○	○	○
PF23	—	○	○	○	○	○	○	○	○	○	○	○	○	○	○	○	○	—
PF24	PF24.0	○	○	○	○	○	○	○	○	○	○	○	○	○	○	○	○	○
PF25	—	○	○	○	○	○	○	○	○	○	○	○	○	○	○	○	○	○
PF29	PF29.1	○	○	○	○	○	○	○	○	○	○	○	○	○	○	○	○	○
PF31	—	○	○	○	○	○	○	○	○	○	○	○	○	○	○	○	○	○
PF32	—	○	○	○	○	○	○	○	—	○	○	—	○	○	○	○	—	○
PF34	PF34.0	○	○	○	○	○	○	○	○	○	○	○	○	○	○	○	○	—
	PF34.1	○	○	○	○	○	○	○	○	○	○	○	○	○	○	○	○	—
	PF34.2	○	○	○	○	○	○	○	○	○	○	○	○	○	○	○	○	○
	PF34.5	○	○	○	○	○	○	○	○	○	○	○	○	○	○	○	○	—
	PF34.6	○	○	○	○	○	○	○	○	○	○	○	○	○	○	○	○	—
PF40	PF40.0	○	○	○	○	○	○	○	○	○	○	○	○	○	○	○	○	—
	PF40.1	○	○	○	○	○	○	○	○	○	○	○	○	○	○	○	○	—
	PF40.2	○	○	○	○	○	○	○	○	○	○	○	○	○	○	○	○	—
	PF40.4	○	○	○	○	○	○	○	○	○	○	○	○	○	○	○	○	—
	PF40.5	○	○	○	○	○	○	○	○	○	○	○	○	○	○	○	○	—
PF41	—	○	○	○	○	○	○	○	○	○	○	○	○	○	○	○	○	○
PF42	—	○	○	○	○	○	○	○	○	○	○	○	○	○	○	○	○	—
PF43	—	○	○	○	○	○	○	○	○	○	○	○	○	○	○	○	○	—
PF45	—	○	○	○	○	○	○	○	○	○	○	○	○	○	○	○	○	—
PF46	—	○	○	○	○	○	○	○	○	○	○	○	○	○	○	○	○	—
PF47	—	○	○	○	○	○	○	○	○	○	○	○	○	○	○	○	○	○
PF62	PF62.0	○	○	○	○	○	○	○	○	○	○	○	○	○	○	○	○	—
PF63	PF63.0	○	○	○	○	○	○	○	○	○	○	○	○	○	○	○	○	○
	PF63.1	○	○	○	—	—	○	○	○	○	○	○	○	○	○	○	○	—
PF66	PF66.0-3	○	—	○	○	○	○	○	—	○	○	—	○	○	○	○	—	—
	PF66.4-7	○	—	○	○	○	○	○	—	○	○	—	○	○	○	○	—	—
PF67	—	○	—	○	○	○	○	○	—	○	○	—	○	○	○	○	—	—
PF68	—	○	—	○	○	○	○	○	—	○	○	—	○	○	○	○	—	—
PF69	—	○	○	○	○	○	○	○	○	○	○	○	○	○	○	○	○	—
PF70	—	○	○	○	○	○	○	○	○	○	○	○	○	○	○	○	○	—
PF71	PF71.0	○	○	○	○	○	○	○	○	○	○	○	○	○	○	○	○	○
	PF71.1	○	○	○	○	○	○	○	○	○	○	○	○	○	○	○	○	○
PF72	—	○	—	○	○	○	○	○	○	○	○	○	○	○	○	○	○	○
PF73	—	○	—	○	○	○	○	○	○	○	○	○	○	○	○	○	○	○
PF74	—	○	—	○	○	○	○	○	○	○	○	○	○	○	○	○	○	○
PF75	—	○	—	○	○	○	○	○	○	○	○	○	○	○	○	○	○	○
PF76	—	○	—	○	○	○	○	○	○	○	○	○	○	○	○	○	○	○

No.	Detail No.	Operation mode					Control mode											
		Semi closed			Fully closed		csp	csv	cst	pp	pv	tq	hm	pt	jg	ct	slt	cspr
		Standard	Linear	DD	Standard	DD												
PF80	PF80.0	○	○	○	○	○	○	○	○	○	○	○	○	○	○	○	○	○
	PF80.2-3	○	○	○	○	○	○	○	○	○	○	○	○	○	○	○	○	○
PF81	PF81.0	○	○	○	○	○	○	○	○	○	○	○	○	○	○	○	○	○
PF82	PF82.0	○	○	○	○	○	○	○	○	○	○	○	○	○	○	○	○	○
	PF82.1	○	○	○	○	○	○	○	○	○	○	○	○	○	○	○	○	○
	PF82.2	○	○	○	○	○	○	○	○	○	○	○	○	○	○	○	○	○
	PF82.3	○	○	○	○	○	○	○	○	○	○	○	○	○	○	○	○	○
PF83	PF83.0	○	○	○	○	○	○	○	○	○	○	○	○	○	○	○	○	○
PF84	PF84.0-1	○	○	○	○	○	○	○	○	○	○	○	○	○	○	○	○	○
	PF84.2-3	○	○	○	○	○	○	○	○	○	○	○	○	○	○	○	○	○
	PF84.4-5	○	○	○	○	○	○	○	○	○	○	○	○	○	○	○	○	○
PF85	—	○	○	○	○	○	○	○	○	○	○	○	○	○	○	○	○	○
PF86	—	○	○	○	○	○	○	○	○	○	○	○	○	○	○	○	○	○
PF87	PF87.0-2	○	○	○	○	○	○	○	○	○	○	○	○	○	○	○	○	○
	PF87.4-6	○	○	○	○	○	○	○	○	○	○	○	○	○	○	○	○	○
PF88	PF88.0-2	○	○	○	○	○	○	○	○	○	○	○	○	○	○	○	○	○
	PF88.4-6	○	○	○	○	○	○	○	○	○	○	○	○	○	○	○	○	○
PF89	PF89.0-2	○	○	○	○	○	○	○	○	○	○	○	○	○	○	○	○	○
	PF89.4-6	○	○	○	○	○	○	○	○	○	○	○	○	○	○	○	○	○
PF90	PF90.0-2	○	○	○	○	○	○	○	○	○	○	○	○	○	○	○	○	○
PF91	PF91.0-3	○	○	○	○	○	○	○	○	○	○	○	○	○	○	○	○	○
	PF91.4-7	○	○	○	○	○	○	○	○	○	○	○	○	○	○	○	○	○
PF92	PF92.0-3	○	○	○	○	○	○	○	○	○	○	○	○	○	○	○	○	○
	PF92.4-7	○	○	○	○	○	○	○	○	○	○	○	○	○	○	○	○	○
PF93	PF93.0-3	○	○	○	○	○	○	○	○	○	○	○	○	○	○	○	○	○
	PF93.4-7	○	○	○	○	○	○	○	○	○	○	○	○	○	○	○	○	○
PF94	PF94.0-3	○	○	○	○	○	○	○	○	○	○	○	○	○	○	○	○	○
	PF94.4-7	○	○	○	○	○	○	○	○	○	○	○	○	○	○	○	○	○
PF95	PF95.0	○	○	○	○	○	○	○	○	○	○	○	○	○	○	○	○	○

Motor extension setting servo parameters group ([Pr. PL_ _])

No.	Detail No.	Operation mode					Control mode											
		Semi closed			Fully closed		csp	csv	cst	pp	pv	tq	hm	pt	jg	ct	slt	cspr
		Standard	Linear	DD	Standard	DD												
PL01	PL01.0	—	○	○	—	○	○	○	○	○	○	○	○	○	○	○	○	○
	PL01.2	—	○	—	—	—	—	—	—	—	—	○	—	—	—	—	—	—
PL02	—	—	○	—	—	—	○	○	○	○	○	○	○	○	○	○	○	○
PL03	—	—	○	—	—	—	○	○	○	○	○	○	○	○	○	○	○	○
PL04	PL04.0	—	○	○	—	○	○	○	○	○	○	○	○	○	○	○	○	○
	PL04.3	—	○	○	—	○	○	○	○	○	○	○	○	○	○	○	○	○
PL05	—	—	○	○	—	○	○	—	—	○	—	—	○	○	○	—	—	—
PL06	—	—	○	○	—	○	○	○	—	○	○	—	○	○	○	○	—	○
PL07	—	—	○	○	—	○	○	○	○	○	○	○	○	○	○	○	○	○
PL08	PL08.0	—	○	○	—	○	○	○	○	○	○	○	○	○	○	○	○	○
	PL08.2	—	○	○	—	○	○	○	○	○	○	○	○	○	○	○	○	○
PL09	—	—	○	○	—	○	○	○	○	○	○	○	○	○	○	○	○	○
PL17	PL17.0	—	○	○	—	○	○	○	○	○	○	○	○	○	○	○	○	○
	PL17.1	—	○	○	—	○	○	○	○	○	○	○	○	○	○	○	○	○
PL18	—	—	○	○	—	○	○	○	○	○	○	○	○	○	○	○	○	○

Positioning control setting servo parameters group ([Pr. PT_ _])

No.	Detail No.	Operation mode					Control mode											
		Semi closed			Fully closed		csp	csv	cst	pp	pv	tq	hm	pt	jg	ct	slt	cspr
		Standard	Linear	DD	Standard	DD												
PT01	PT01.1	○	○	○	○	○	○	○	○	○	○	○	○	○	○	○	○	○
	PT01.2	○	○	○	○	○	○	○	○	○	○	○	○	○	○	○	○	○
PT02	PT02.7	○	○	○	○	○	—	—	—	○	—	—	○	○	—	—	—	
PT03	PT03.2	○	—	○	—	—	—	—	—	○	—	—	—	○	—	—	—	
PT05	—	○	○	○	○	○	—	—	—	—	—	—	○	—	—	—	—	
PT06	—	○	○	○	○	○	—	—	—	—	—	—	○	—	—	—	—	
PT07	—	○	○	○	○	○	○	○	○	○	○	○	○	○	○	—	○	
PT08	—	○	○	○	○	○	○	—	—	○	○	○	○	○	○	—	—	
PT09	—	○	○	○	○	○	○	○	○	○	○	○	○	○	○	—	○	
PT10	—	○	○	○	○	○	○	○	○	○	○	○	○	○	○	—	○	
PT11	—	○	○	○	○	○	○	○	○	○	○	○	○	○	○	—	○	
PT12	—	○	○	○	○	○	—	—	—	○	—	—	○	○	—	—	—	
PT15	—	○	○	○	○	○	○	—	—	○	—	—	—	○	○	—	—	
PT17	—	○	○	○	○	○	○	—	—	○	—	—	—	○	○	—	—	
PT19	—	○	○	○	○	○	○	—	—	○	—	—	—	○	○	—	—	
PT21	—	○	○	○	○	○	○	—	—	○	—	—	—	○	○	—	—	
PT26	PT26.4	○	○	○	○	○	○	○	○	○	○	○	○	○	○	○	○	
PT29	PT29.0	○	○	○	○	○	○	○	○	○	○	○	○	○	○	○	○	
PT34	PT34.0	○	○	○	○	○	○	○	○	○	○	○	○	○	○	○	—	
	PT34.3	○	○	○	○	○	○	○	○	○	○	○	○	○	○	○	—	
PT38	PT38.1	○	○	○	○	○	—	—	—	—	—	—	○	○	○	—	—	
	PT38.4	○	○	○	○	○	○	○	—	—	—	—	—	—	—	—	—	
PT41	PT41.0	○	○	○	○	○	—	—	—	—	—	—	○	—	—	—	—	
PT45	—	○	○	○	○	○	—	—	—	—	—	—	○	—	—	—	—	
PT49	—	○	○	○	○	○	—	—	—	○	○	—	—	—	○	—	—	
PT50	—	○	○	○	○	○	—	—	—	○	○	—	—	—	○	—	—	
PT51	—	○	○	○	○	○	—	—	—	○	○	—	—	○	○	—	—	
PT53	—	○	○	○	○	○	—	—	—	—	—	○	—	—	—	—	—	
PT55	PT55.0	○	○	○	○	○	—	—	—	—	—	—	○	—	—	—	—	
	PT55.1	○	○	○	○	○	—	—	—	—	—	—	○	—	—	—	—	
PT56	—	○	○	○	○	○	—	—	—	—	—	—	○	—	—	—	—	
PT57	—	○	○	○	○	○	—	—	—	—	—	—	○	—	—	—	—	
PT65	—	○	○	○	○	○	—	—	—	○	—	—	—	—	○	—	—	
PT66	—	○	○	○	○	○	—	—	—	○	○	—	—	—	○	—	—	
PT67	—	○	○	○	○	○	—	—	○	—	—	○	—	—	—	○	○	
PT68	PT68.0	○	○	○	○	○	○	○	—	○	○	—	○	○	○	—	—	
	PT68.2	○	○	○	○	○	—	—	—	○	○	○	○	○	○	—	—	
PT83	PT83.2	○	○	○	○	○	—	—	—	—	—	—	—	○	—	—	—	
PT85	PT85.0	○	—	—	—	—	○	—	—	—	—	—	○	—	—	—	○	

Network setting servo parameters group ([Pr. PN_ _])

No.	Detail No.	Operation mode					Control mode											
		Semi closed			Fully closed		csp	csv	cst	pp	pv	tq	hm	pt	jg	ct	slt	cspr
		Standard	Linear	DD	Standard	DD												
PN02	—	○	○	○	○	○	○	○	○	○	○	○	○	○	○	○	○	○
PN03	PN03.1	○	○	○	○	○	○	○	○	○	○	○	○	○	○	○	○	○
	PN03.3	○	○	○	○	○	○	○	○	○	○	○	○	○	○	—	○	○
PN05	—	○	○	○	○	○	○	○	○	○	○	○	○	○	○	○	○	○
PN06	PN06.6	○	○	○	○	○	○	○	○	○	○	○	○	○	○	—	○	○
PN07	—	○	○	○	○	○	○	○	○	○	○	○	○	○	○	○	○	○
PN13	PN13.0-3	○	○	○	○	○	○	○	○	○	○	○	○	○	○	○	○	○
PN18	—	○	○	○	○	○	○	○	○	○	○	○	○	○	○	○	○	○
PN19	PN19.1	○	○	○	○	○	○	○	○	○	○	○	○	○	○	○	○	○
PN20	—	○	○	○	○	○	○	○	○	○	○	○	○	○	○	○	○	○
PN22	PN22.0	○	○	○	○	○	○	○	○	○	○	○	○	○	○	○	○	○
PN33	—	○	○	○	○	○	○	○	○	○	○	○	○	○	○	○	○	○
PN34	—	○	○	○	○	○	○	○	○	○	○	○	○	○	○	○	○	○

Positioning extension setting servo parameters group ([Pr. PV_ _])

No.	Detail No.	Operation mode					Control mode											
		Semi closed			Fully closed		csp	csv	cst	pp	pv	tq	hm	pt	jg	ct	slt	cspr
		Standard	Linear	DD	Standard	DD												
PV01	—	○	○	○	○	○	—	—	—	○	—	—	—	○	—	—	—	
PV03	—	○	○	○	○	○	—	—	—	○	○	—	—	—	○	—	—	
PV05	—	○	○	○	○	○	—	—	—	○	○	—	—	—	○	—	—	
PV07	—	○	○	○	○	○	—	—	—	○	○	—	—	—	○	—	—	
PV09	—	○	○	○	○	○	○	○	—	○	○	—	○	○	○	—	—	
PV11	—	○	○	○	○	○	—	—	—	—	—	—	○	—	—	—	—	
PV13	—	○	○	○	○	○	—	—	—	—	—	—	○	—	—	—	—	
PV15	—	○	○	○	○	○	—	—	—	—	—	—	○	—	—	—	—	
PV17	—	○	○	○	○	○	—	—	—	—	—	—	○	—	—	—	—	
PV19	—	○	○	○	○	○	—	—	—	—	○	—	—	—	—	—	—	
PV20	—	○	○	○	○	○	—	—	—	—	○	—	—	—	—	—	—	
PV21	—	○	○	○	○	○	—	—	○	—	—	○	—	—	○	○	○	
PV23	—	○	○	○	○	○	○	○	○	○	○	○	○	○	○	—	○	
PV24	—	○	○	○	○	○	○	○	○	○	○	○	○	○	○	—	○	
PV25	—	○	○	○	○	○	○	○	○	○	○	○	○	○	○	—	○	
PV26	—	○	○	○	○	○	○	○	○	○	○	○	○	○	○	—	○	
PV29	—	○	○	○	○	○	—	—	—	○	○	—	○	—	○	—	—	
PV31	—	○	○	○	○	○	—	—	—	○	○	—	○	—	○	—	—	
PV33	—	○	—	—	—	—	—	—	—	—	—	—	—	—	—	—	—	

Extension setting 4 servo parameters group ([Pr. PW_ _])

No.	Detail No.	Operation mode					Control mode												
		Semi closed			Fully closed		csp	csv	cst	pp	pv	tq	hm	pt	jg	ct	slt	cspr	
		Standard	Linear	DD	Standard	DD													
PW01	—	○	○	—	—	—	—	—	—	—	—	—	—	—	—	—	—	○	
PW02	—	○	○	—	—	—	—	—	—	—	—	—	—	—	—	—	—	○	
PW03	—	○	○	—	—	—	—	—	—	—	—	—	—	—	—	—	—	○	
PW12	PW12.1	○	○	—	—	—	—	—	—	—	—	—	—	—	—	—	—	○	
	PW12.2	○	○	—	—	—	—	—	—	—	—	—	—	—	—	—	—	○	
PW13	PW13.0	○	○	—	—	—	—	—	—	—	—	—	—	—	—	—	—	○	
	PW13.1	○	○	—	—	—	—	—	—	—	—	—	—	—	—	—	—	○	
	PW13.4	○	○	—	—	—	—	—	—	—	—	—	—	—	—	—	—	○	
PW20	PW20.1	○	○	—	—	—	—	—	—	—	—	—	—	—	—	—	—	○	
PW21	—	○	○	—	—	—	—	—	—	—	—	—	—	—	—	—	—	○	
PW22	—	○	○	—	—	—	—	—	—	—	—	—	—	—	—	—	—	○	
PW23	—	○	○	—	—	—	—	—	—	—	—	—	—	—	—	—	—	○	
PW24	—	○	○	—	—	—	—	—	—	—	—	—	—	—	—	—	—	○	
PW25	—	○	○	—	—	—	—	—	—	—	—	—	—	—	—	—	—	○	
PW26	—	○	○	—	—	—	—	—	—	—	—	—	—	—	—	—	—	○	
PW27	PW27.0	○	○	—	—	—	—	—	—	—	—	—	—	—	—	—	—	○	
	PW27.1	○	○	—	—	—	—	—	—	—	—	—	—	—	—	—	—	○	
	PW27.2	○	○	—	—	—	—	—	—	—	—	—	—	—	—	—	—	○	
PW33	PW33.0	○	○	—	—	—	—	—	—	—	—	—	—	—	—	—	—	○	
	PW33.1	○	○	—	—	—	—	—	—	—	—	—	—	—	—	—	—	○	
	PW33.2	○	○	—	—	—	—	—	—	—	—	—	—	—	—	—	—	○	
PW34	PW34.0	○	○	—	—	—	—	—	—	—	—	—	—	—	—	—	—	○	
PW35	—	○	○	—	—	—	—	—	—	—	—	—	—	—	—	—	—	○	
PW36	—	○	○	—	—	—	—	—	—	—	—	—	—	—	—	—	—	○	
PW38	—	○	○	—	—	—	—	—	—	—	—	—	—	—	—	—	—	○	

3 LISTS OF SERVO PARAMETER INITIAL VALUES

3.1 Basic setting servo parameters group ([Pr. PA_ _])

No.	Setting method	Initial value
PA01	Each axis	00003000h
PA02	Common	00000000h
PA03	Each axis	00000000h
PA04	Common	00002000h
PA05	—	10000
PA06	Each axis	1
PA07	Each axis	1
PA08	Each axis	00000001h
PA09	Each axis	16
PA10	Each axis	25600
PA11	Each axis	1000.0
PA12	Each axis	1000.0
PA13	—	00000000h
PA14	Each axis	0
PA15	Each axis	4000
PA16	Each axis	1
PA17	Each axis	00000000h
PA18	Each axis	00000000h
PA19	Each axis	000000ABh
PA20	Each axis	00000000h
PA21	Each axis	00000001h
PA22	Each axis	00000000h
PA23	Common	00000000h
PA24	Each axis	00000000h
PA25	Each axis	0
PA26	Each axis	00000000h
PA27	—	00000000h
PA28	Each axis	00000000h
PA29	—	0
PA30	—	0
PA31	—	0
PA32	—	00000000h
PA33	—	0.0
PA34	Each axis	0
PA35	—	00000000h
PA36	—	00000000h
PA37	—	00000000h
PA38	—	00000000h
PA39	—	00000000h
PA40	—	00000000h
PA41	—	00000000h
PA42	—	00000000h
PA43	—	00000000h
PA44	—	00000000h

3.2 Gain/filter setting servo parameters group ([Pr. PB_ _])

No.	Setting method	Initial value
PB01	Each axis	00000000h
PB02	Each axis	00000000h
PB03	Each axis	36000
PB04	Each axis	0
PB05	—	500
PB06	Each axis	7.00
PB07	Each axis	15.0
PB08	Each axis	37.0
PB09	Each axis	823
PB10	Each axis	33.7
PB11	Each axis	980
PB12	Each axis	0
PB13	Each axis	4500
PB14	Each axis	00000000h
PB15	Each axis	4500
PB16	Each axis	00000000h
PB17	Each axis	00000000h
PB18	Each axis	3141
PB19	Each axis	100.0
PB20	Each axis	100.0
PB21	Each axis	0.00
PB22	Each axis	0.00
PB23	Each axis	00001000h
PB24	Each axis	00000000h
PB25	Each axis	00000000h
PB26	Each axis	00000000h
PB27	Each axis	10
PB28	Each axis	1
PB29	Each axis	7.00
PB30	Each axis	0.0
PB31	Each axis	0
PB32	Each axis	0.0
PB33	Each axis	0.0
PB34	Each axis	0.0
PB35	Each axis	0.00
PB36	Each axis	0.00
PB37	—	1600
PB38	—	0.000
PB39	—	0.000
PB40	—	0.000
PB41	—	00000000h
PB42	—	00000000h
PB43	—	00000000h
PB44	—	0.00
PB45	Each axis	00000000h
PB46	Each axis	4500
PB47	Each axis	00000000h
PB48	Each axis	4500

No.	Setting method	Initial value
PB49	Each axis	00000000h
PB50	Each axis	4500
PB51	Each axis	00000000h
PB52	Each axis	100.0
PB53	Each axis	100.0
PB54	Each axis	0.00
PB55	Each axis	0.00
PB56	Each axis	0.0
PB57	Each axis	0.0
PB58	Each axis	0.00
PB59	Each axis	0.00
PB60	Each axis	0.0
PB61	—	0.0
PB62	—	00000000h
PB63	—	00000000h
PB64	—	00000000h
PB65	Each axis	10
PB66	Each axis	1
PB67	Each axis	7.00
PB68	Each axis	0.0
PB69	Each axis	0
PB70	Each axis	0.0
PB71	Each axis	0.0
PB72	Each axis	0.0
PB73	Each axis	0.00
PB74	Each axis	0.00
PB75	Each axis	0.0
PB76	Each axis	0.0
PB77	Each axis	0.00
PB78	Each axis	0.00
PB79	Each axis	0.0
PB80	—	177.0
PB81	Each axis	00000001h
PB82	Each axis	0.0
PB83	—	00000000h
PB84	—	00000000h
PB85	—	00000000h
PB86	—	00000000h
PB87	—	0
PB88	—	00000000h
PB89	—	00000000h
PB90	—	00000000h
PB91	—	00000000h
PB92	—	00000000h

3.3 Extension setting servo parameters group ([Pr. PC_ _])

No.	Setting method	Initial value	
		J5G	J5G-N1
PC01	Each axis	0	
PC02	Each axis	0	
PC03	Each axis	0000000h	
PC04	Each axis	0000000h	
PC05	Each axis	0000000h	
PC06	Each axis	0000000h	
PC07	Each axis	50	
PC08	Each axis	0	
PC09	Common	0000000h	
PC10	Common	0000001h	
PC11	Common	0	
PC12	Common	0	
PC13	—	0	
PC14	—	0	
PC15	—	0	
PC16	Each axis	0000000h	
PC17	Each axis	0000000h	
PC18	—	0000000h	
PC19	Each axis	0000000h	
PC20	Common	0000000h	
PC21	Each axis	0000000h	
PC22	—	0	
PC23	—	0000000h	
PC24	Each axis	100	
PC25	—	0	
PC26	Each axis	00000050h	
PC27	Each axis	0000000h	
PC28	—	0000000h	
PC29	Each axis	00101000h	
PC30	—	0	
PC31	Each axis	0	
PC32	—	0	
PC33	—	0	
PC34	—	100	
PC35	—	0000000h	
PC36	—	0000000h	
PC37	—	0000000h	
PC38	Each axis	0	
PC39	—	0.0	
PC40	—	0.0	
PC41	Each axis	0000000h	
PC42	Each axis	0000000h	
PC43	Each axis	0.0	1000.0
PC44	Each axis	0.0	1000.0
PC45	—	0000000h	
PC46	Common	0000000h	
PC47	—	0000000h	

No.	Setting method	Initial value	
		J5G	J5G-N1
PC48	—	00000000h	
PC49	—	00000000h	
PC50	—	00000000h	
PC51	—	00000000h	
PC52	—	00000000h	
PC53	—	00000000h	
PC54	—	00000000h	
PC55	—	00000000h	
PC56	—	00000000h	
PC57	—	00000000h	
PC58	—	00000000h	
PC59	—	00000000h	
PC60	—	00000000h	
PC61	—	00000000h	
PC62	—	00000000h	
PC63	—	00000000h	
PC64	—	00000000h	
PC65	Each axis	50.00	
PC66	Each axis	10	
PC67	Each axis	00C00000h	
PC68	—	00000000h	
PC69	Each axis	10	0
PC70	Each axis	400	
PC71	Each axis	10	0
PC72	Each axis	20.00	
PC73	Each axis	10	0
PC74	—	10.0	
PC75	—	10	
PC76	Each axis	00000001h	
PC77	—	1000.0	
PC78	Each axis	00000000h	00000010h
PC79	Each axis	00000000h	
PC80	—	00000000h	
PC81	—	00000000h	
PC82	—	0	
PC83	—	0	
PC84	—	00000000h	
PC85	—	00000000h	
PC86	—	00000000h	
PC87	—	00000000h	
PC88	—	00000000h	
PC89	—	00000000h	
PC90	—	00000000h	
PC91	—	00000000h	
PC92	—	00000000h	
PC93	—	00000000h	
PC94	—	00000000h	
PC95	—	00000000h	
PC96	Each axis	0	

3.4 I/O setting servo parameters group ([Pr. PD_ _])

No.	Setting method	Initial value
PD01	Each axis	00000000h
PD02	—	00000000h
PD03	Each axis	0000000Ah
PD04	Each axis	0000000Bh
PD05	Each axis	00000022h
PD06	—	00000000h
PD07	Each axis	00000005h
PD08	Common	00000004h
PD09	Common	00000003h
PD10	—	00000000h
PD11	Common	00000007h
PD12	Each axis	00000101h
PD13	Each axis	00000000h
PD14	Each axis	00000000h
PD15	Each axis	00000000h
PD16	—	00000000h
PD17	—	00000000h
PD18	—	00000000h
PD19	—	00000000h
PD20	—	0
PD21	—	0
PD22	Each axis	0
PD23	Each axis	0
PD24	—	0
PD25	—	00000000h
PD26	Each axis	00000000h
PD27	—	0
PD28	—	00000000h
PD29	—	00000000h
PD30	Each axis	0
PD31	Each axis	0
PD32	Each axis	0
PD33	—	00000000h
PD34	—	00000000h
PD35	—	00000000h
PD36	—	00000000h
PD37	—	00110001h
PD38	Each axis	0000002Ch
PD39	Each axis	0000002Dh
PD40	—	0
PD41	Each axis	00000000h
PD42	—	00000000h
PD43	—	00000000h
PD44	—	00000000h
PD45	—	00000000h
PD46	—	00000000h
PD47	—	00000000h
PD48	—	00000000h
PD49	—	0
PD50	—	0

No.	Setting method	Initial value
PD51	Common	0000062h
PD52	—	0000000h
PD53	—	0000000h
PD54	—	0000000h
PD55	—	0000000h
PD56	—	0000000h
PD57	—	0000000h
PD58	—	0000000h
PD59	—	0000000h
PD60	Each axis	0000000h
PD61	—	0000000h
PD62	—	0000000h
PD63	—	0000000h
PD64	—	0000000h
PD65	—	0000000h
PD66	—	0000000h
PD67	—	0000000h
PD68	—	0000000h
PD69	—	0000000h
PD70	—	0000000h
PD71	—	0000000h
PD72	—	0000000h

3.5 Extension setting 2 servo parameters group ([Pr. PE_ _])

No.	Setting method	Initial value	
		J5G	J5G-N1
PE01	Each axis	00000000h	
PE02	—	00000000h	
PE03	Each axis	00000003h	
PE04	Each axis	1	
PE05	Each axis	1	
PE06	Each axis	400	
PE07	Each axis	100	
PE08	Each axis	10	
PE09	—	00000000h	
PE10	Each axis	00000000h	
PE11	—	00000000h	
PE12	—	00000000h	
PE13	—	00000000h	
PE14	—	00000111h	
PE15	—	20	
PE16	—	00000000h	
PE17	—	00000100h	
PE18	—	00000000h	
PE19	—	00000000h	
PE20	—	00000000h	
PE21	—	00000000h	
PE22	—	00000000h	
PE23	—	00000000h	
PE24	—	00000000h	
PE25	—	00000000h	
PE26	—	00000000h	
PE27	—	00000000h	
PE28	—	00000000h	
PE29	—	00000000h	
PE30	—	00000000h	
PE31	—	00000000h	
PE32	—	00000000h	
PE33	—	00000000h	
PE34	—	1	
PE35	—	1	
PE36	—	0.0	
PE37	—	0.00	
PE38	—	0.00	
PE39	—	20	
PE40	—	00000000h	
PE41	Each axis	00000000h	
PE42	—	0	
PE43	—	0.0	
PE44	Each axis	0	
PE45	Each axis	0	
PE46	Each axis	0	
PE47	Each axis	0	

No.	Setting method	Initial value	
		J5G	J5G-N1
PE48	Each axis	00000000h	
PE49	Each axis	0	
PE50	Each axis	0	
PE51	Each axis	0	
PE52	—	00000000h	
PE53	Each axis	0.0	1000.0
PE54	—	00000000h	
PE55	—	00000000h	
PE56	—	00000000h	
PE57	—	00000000h	
PE58	—	00000000h	
PE59	—	00000000h	
PE60	—	00000000h	
PE61	—	0.000	
PE62	—	0.000	
PE63	—	0.000	
PE64	—	0.000	
PE65	—	0.0	
PE66	—	0.0	
PE67	—	0.0	
PE68	—	00000000h	
PE69	—	00000000h	
PE70	—	0.00	
PE71	—	0	
PE72	—	1.0000	
PE73	—	00000000h	
PE74	—	00000000h	
PE75	—	00000000h	
PE76	—	00000000h	
PE77	—	00000000h	
PE78	—	0	
PE79	—	0	
PE80	—	00000000h	
PE81	—	00000000h	
PE82	—	00000000h	
PE83	—	00000000h	
PE84	—	00000000h	
PE85	—	00000000h	
PE86	—	00000000h	
PE87	—	00000000h	
PE88	—	00000000h	

3.6 Extension setting 3 servo parameters group ([Pr. PF_ _])

No.	Setting method	Initial value
PF01	—	00000000h
PF02	Common	00000000h
PF03	—	00000000h
PF04	—	0
PF05	—	00000000h
PF06	Each axis	00000013h
PF07	—	00000000h
PF08	—	00000000h
PF09	—	00000000h
PF10	—	00000000h
PF11	—	00000000h
PF12	Each axis	2000
PF13	—	00000000h
PF14	—	10
PF15	—	00000000h
PF16	—	00000000h
PF17	—	00000000h
PF18	Common	10
PF19	Each axis	0
PF20	Each axis	0
PF21	Common	0
PF22	—	200
PF23	Each axis	20
PF24	Each axis	00000000h
PF25	Common	200
PF26	—	0
PF27	—	0
PF28	—	0
PF29	Each axis	00000000h
PF30	—	0
PF31	Each axis	0
PF32	Each axis	50
PF33	—	00000000h
PF34	Each axis	00000000h
PF35	—	00000000h
PF36	—	00000000h
PF37	—	00000000h
PF38	—	00000000h
PF39	—	00000000h
PF40	Each axis	00000000h
PF41	Each axis	0
PF42	Each axis	0
PF43	Each axis	0
PF44	—	0
PF45	Each axis	0
PF46	Each axis	0
PF47	Each axis	0
PF48	—	00000000h

No.	Setting method	Initial value
PF49	—	100
PF50	—	100
PF51	—	00000000h
PF52	—	00000000h
PF53	—	0
PF54	—	0
PF55	—	0
PF56	—	0
PF57	—	00000000h
PF58	—	00000000h
PF59	—	00000000h
PF60	—	00000000h
PF61	—	00000000h
PF62	Each axis	00000000h
PF63	Each axis	00000000h
PF64	—	0
PF65	—	00000000h
PF66	Each axis	00000000h
PF67	Each axis	0
PF68	Each axis	0
PF69	Each axis	0
PF70	Each axis	0
PF71	Each axis	00000000h
PF72	Each axis	0
PF73	Each axis	0
PF74	Each axis	0
PF75	Each axis	0
PF76	Each axis	0
PF77	—	00000000h
PF78	—	00000000h
PF79	—	00110010h
PF80	Each axis	00000000h
PF81	Each axis	00000000h
PF82	Each axis	00000000h
PF83	Common	00000000h
PF84	Each axis	005A8101h
PF85	Each axis	0
PF86	Each axis	0
PF87	Each axis	00020201h
PF88	Each axis	02040003h
PF89	Each axis	00090205h
PF90	Each axis	0000000Ch
PF91	Each axis	00120000h
PF92	Each axis	80058010h
PF93	Each axis	8000800Ah
PF94	Each axis	801D8015h
PF95	Each axis	00000000h
PF96	—	00000000h
PF97	—	00000000h
PF98	—	00000000h
PF99	—	00000000h

3.7 Motor extension setting servo parameters group ([Pr. PL_ _])

No.	Setting method	Initial value
PL01	Each axis	00000301h
PL02	Each axis	1000
PL03	Each axis	1000
PL04	Each axis	00000003h
PL05	Each axis	0
PL06	Each axis	0
PL07	Each axis	100
PL08	Each axis	00001010h
PL09	Each axis	30
PL10	—	5
PL11	—	100
PL12	—	500
PL13	—	00000000h
PL14	—	00000000h
PL15	—	20
PL16	—	0
PL17	Each axis	00000000h
PL18	Each axis	0
PL19	—	0
PL20	—	0
PL21	—	0
PL22	—	0
PL23	—	00000000h
PL24	—	0
PL25	—	0
PL26	—	00000000h
PL27	—	00000000h
PL28	—	00000000h
PL29	—	0
PL30	—	00000000h
PL31	—	00000000h
PL32	—	00000000h
PL33	—	00000000h
PL34	—	00000000h
PL35	—	00000000h
PL36	—	00000000h
PL37	—	00000000h
PL38	—	00000000h
PL39	—	00000000h
PL40	—	00000000h
PL41	—	00000000h
PL42	—	00000000h
PL43	—	00000000h
PL44	—	00000000h
PL45	—	00000000h
PL46	—	00000000h
PL47	—	00000000h
PL48	—	00000000h

No.	Setting method	Initial value
PL49	—	00000000h
PL50	—	0
PL51	—	0
PL52	—	12
PL53	—	0
PL54	—	00000000h
PL55	—	00000000h
PL56	—	00000000h
PL57	—	00000000h
PL58	—	00000000h
PL59	—	00000000h
PL60	—	00000000h
PL61	—	00000000h
PL62	—	00000000h
PL63	—	00000000h
PL64	—	00000000h
PL65	—	00000000h
PL66	—	00000000h
PL67	—	00000000h
PL68	—	00000000h
PL69	—	00000000h
PL70	—	00000000h
PL71	—	00000000h
PL72	—	00000000h

3.8 Positioning control setting servo parameters group ([Pr. PT_ _])

No.	Setting method	Initial value	
		J5G	J5G-N1
PT01	Each axis	00000300h	00000310h
PT02	Each axis	00000001h	
PT03	Each axis	00000000h	
PT04	—	00000000h	
PT05	Each axis	100.00	
PT06	Each axis	10.00	
PT07	Each axis	0	
PT08	Each axis	0	
PT09	Each axis	1000	
PT10	Each axis	100	
PT11	Each axis	15.0	
PT12	Each axis	0	
PT13	—	00000000h	
PT14	—	0	
PT15	Each axis	0	
PT16	—	00000000h	
PT17	Each axis	0	
PT18	—	00000000h	
PT19	Each axis	0	
PT20	—	00000000h	
PT21	Each axis	0	
PT22	—	00000000h	
PT23	—	00000000h	
PT24	—	00000000h	
PT25	—	00000000h	
PT26	Each axis	00000000h	
PT27	—	00000000h	
PT28	—	8	
PT29	Each axis	00000000h	
PT30	—	00000000h	
PT31	—	00000000h	
PT32	—	00000100h	
PT33	—	00000000h	
PT34	Each axis	00000000h	
PT35	—	00000000h	
PT36	—	00000000h	
PT37	—	10	
PT38	Each axis	00000000h	
PT39	—	100	
PT40	—	0	
PT41	Each axis	00000010h	
PT42	—	00000000h	
PT43	—	00000000h	
PT44	—	00000000h	
PT45	Each axis	37	
PT46	—	0	
PT47	—	00000000h	

No.	Setting method	Initial value	
		J5G	J5G-N1
PT48	—	00000000h	
PT49	Each axis	0	
PT50	Each axis	0	
PT51	Each axis	0	
PT52	—	0	
PT53	Each axis	0.0	100.0
PT54	—	0	
PT55	Each axis	00000000h	
PT56	Each axis	0	
PT57	Each axis	0	
PT58	—	100.00	
PT59	—	500.00	
PT60	—	1000.00	
PT61	—	200.00	
PT62	—	00000000h	
PT63	—	00000000h	
PT64	—	00000000h	
PT65	Each axis	100.00	
PT66	Each axis	20000.00	
PT67	Each axis	3000.00	
PT68	Each axis	00000002h	
PT69	—	00000000h	
PT70	—	00000000h	
PT71	—	00000000h	
PT72	—	1	
PT73	—	00000000h	
PT74	—	1	
PT75	—	00000000h	
PT76	—	00000000h	
PT77	—	00000000h	
PT78	—	00000000h	
PT79	—	00000000h	
PT80	—	00000000h	
PT81	—	0	
PT82	—	0	
PT83	Each axis	00000000h	
PT84	—	00000000h	
PT85	Each axis	00000000h	
PT86	—	00000000h	
PT87	—	00000000h	
PT88	—	00000000h	
PT89	—	00000000h	
PT90	—	00000000h	

3.9 Network setting servo parameters group ([Pr. PN_ _])

No.	Setting method	Initial value	
		J5G	J5G-N1
PN01	—	00000000h	
PN02	Common	0	
PN03	Common	00000000h	
PN04	—	0	
PN05	Common	0	
PN06	—	00000000h	
PN07	Common	00000000h	
PN08	—	00000000h	
PN09	—	1	
PN10	—	0	
PN11	—	3600	
PN12	—	00000000h	
PN13	Common	00000000h	00000100h
PN14	—	00000000h	
PN15	—	00000000h	
PN16	—	00000000h	
PN17	—	00000000h	
PN18	Common	0	
PN19	Common	00000000h	
PN20	Common	0	
PN21	—	00000000h	
PN22	Each axis	00000000h	
PN23	—	0	
PN24	—	00000000h	
PN25	—	00000000h	
PN26	—	00000000h	
PN27	—	00000000h	
PN28	—	00000000h	
PN29	—	00000000h	
PN30	—	00000000h	
PN31	—	00000000h	
PN32	—	00000000h	
PN33	Each axis	FFFFFFFFh	
PN34	Each axis	FFFFFFFFh	

3.10 Positioning extension setting servo parameters group ([Pr. PV_ _])

No.	Setting method	Initial value
PV01	Each axis	0
PV02	—	0
PV03	Each axis	2147483647
PV04	—	0
PV05	Each axis	0
PV06	—	0
PV07	Each axis	0
PV08	—	0
PV09	Each axis	0
PV10	—	0
PV11	Each axis	500000
PV12	—	0
PV13	Each axis	100000
PV14	—	0
PV15	Each axis	0
PV16	—	0
PV17	Each axis	0
PV18	—	0
PV19	Each axis	20000
PV20	Each axis	20
PV21	Each axis	2147483647
PV22	—	0
PV23	Each axis	1
PV24	Each axis	1
PV25	Each axis	1
PV26	Each axis	1
PV27	—	1
PV28	—	1
PV29	Each axis	0
PV30	—	00000000h
PV31	Each axis	0
PV32	—	0
PV33	Each axis	0
PV34	—	0
PV35	—	00000000h
PV36	—	00000000h
PV37	—	00000000h
PV38	—	00000000h
PV39	—	00000000h
PV40	—	00000000h

3.11 Extension setting 4 servo parameters group ([Pr. PW_ _])

No.	Setting method	Initial value
PW01	Each axis	800
PW02	Each axis	75
PW03	Each axis	10000
PW04	—	0
PW05	—	0.0
PW06	—	0
PW07	—	0
PW08	—	0
PW09	—	0
PW10	—	0
PW11	—	0
PW12	Each axis	00000000h
PW13	Each axis	00000000h
PW14	—	00000000h
PW15	—	00000000h
PW16	—	00000000h
PW17	—	0
PW18	—	0
PW19	—	0
PW20	Each axis	00000000h
PW21	Each axis	0
PW22	Each axis	20000
PW23	Each axis	0
PW24	Each axis	20000
PW25	Each axis	0
PW26	Each axis	20000
PW27	Each axis	00000000h
PW28	—	0
PW29	—	0.0
PW30	—	0
PW31	—	0
PW32	—	00000000h
PW33	Each axis	00000000h
PW34	Each axis	00000000h
PW35	Each axis	20
PW36	Each axis	100000
PW37	—	0
PW38	—	1
PW39	—	00000000h
PW40	—	00000000h
PW41	—	00000000h
PW42	—	00000000h
PW43	—	00000000h
PW44	—	00000000h
PW45	—	00000000h
PW46	—	00000000h
PW47	—	00000000h
PW48	—	00000000h

No.	Setting method	Initial value
PW49	—	00000000h
PW50	—	00000000h

4 SERVO PARAMETER SETTING METHOD

Servo parameters can be set using the methods shown below. Set the servo parameters using one of these methods.

4.1 Engineering software

Servo parameters can be set using the engineering software manufactured by Mitsubishi Electric such as MR Configurator2. Connect a personal computer and the servo amplifier via a USB cable or a network. For details on how to set servo parameters, refer to Help or the manual for the engineering software.

4.2 Object dictionary

The servo parameters can be changed by writing values on servo parameter objects. The servo parameters can also be changed with objects other than the servo parameter objects that interlock and change with the servo parameters. An example is shown in the table below. Note that if the power is cycled, the changed settings are not retained at the next startup. To retain the changed settings even after cycling the power, save the servo parameter setting value to the non-volatile memory by using [Store parameters (Obj. 1010h)].

To change the setting of the parameters in which the setting changes are reflected by cycling the power or by resetting the software (parameters whose symbols are preceded by **), change the value of the corresponding object, execute [Store parameters (Obj. 1010h)], and then cycle the power or reset the software.

Servo parameter	Servo parameter object	An object other than the servo parameter object that interlocks and changes with the servo parameter
[Pr. PT45 Homing method]	[PT45 (Obj. 24ADh)]	[Homing method (Obj. 6098h)]

5 NETWORK PARAMETER DETAILS

Network parameters are used to set IP addresses and other information necessary to connect the servo amplifier with the controllers and other network equipment. In this chapter, an outline of the network parameters and the contents of each setting are explained.

The network function of the servo amplifier is set with the network parameters. The network parameters are stored in the non-volatile memory of the servo amplifier, and are set to the initial value when using the factory setting. Change the settings as necessary. Refer to the following for the setting methods.

☞ Page 240 SERVO PARAMETER SETTING METHOD

Restrictions

Depending on the model of the motion module, servo amplifier firmware version, and MR Configurator2 software version, some network parameters and ranges cannot be set. Refer to the Mitsubishi Electric FA site for the latest software version of MR Configurator2.

In addition, the firmware version of the servo amplifier can be checked with MR Configurator2, objects, or by other means. When using servo motors with functional safety, executing software reset may trigger [AL. 016 Encoder initial communication error 1]. If [AL. 016] occurs, cycle the power.

Precautions

Do not change the network parameter settings as described below. Doing so may cause an unexpected condition, such as failing to start up the servo amplifier.

- Changing the values of the network parameters for manufacturer setting.
- Setting a value outside the range
- Changing the fixed value in each digit

If the method for reflecting the setting value of the network parameter is not stated, the value is enabled at the moment that it is changed.

Some of the network parameters support SLMP communication. For example, SLMP commands (IPAddressSet) are written to the IP addresses of the network parameters.

5.1 Network basic parameters

[Pr. NPA01_IP address setting]

Supported firmware version				
TSN	CIB	ECT	EIP	—
A0	C0	—	—	—

Initial value	Setting range	Size
0	Refer to the text	4 bytes

For the setting of IP addresses which are necessary for communication, select whether to use the rotary switches or to use network parameters to obtain the IP addresses.

To enable this network parameter, cycle the power or reset the software after setting.

This network parameter cannot be rewritten via the parameter automatic setting.

Setting value	Rotary switches (SW1/SW2)	IP address	
0: The rotary switch is used.	00h	1st octet	The 1st octet of the setting value in [Pr. NPA02] is used.
		2nd octet	The 2nd octet of the setting value in [Pr. NPA02] is used.
		3rd octet	The 3rd octet of the setting value in [Pr. NPA02] is used.
		4th octet	The 4th octet of the setting value in [Pr. NPA02] is used.
	01h to FEh	1st octet	The 1st octet of the setting value in [Pr. NPA02] is used.
		2nd octet	The 2nd octet of the setting value in [Pr. NPA02] is used.
		3rd octet	The 3rd octet of the setting value in [Pr. NPA02] is used.
		4th octet	The setting value of the rotary switch (SW1/SW2) is used.
	FFh	1st octet	Not used
		2nd octet	
		3rd octet	
		4th octet	
1: The network parameter is used.	—	1st octet	The 1st octet of the setting value in [Pr. NPA02] is used.
		2nd octet	The 2nd octet of the setting value in [Pr. NPA02] is used.
		3rd octet	The 3rd octet of the setting value in [Pr. NPA02] is used.
		4th octet	The 4th octet of the setting value in [Pr. NPA02] is used.

The initial value of the IP address is as follows.

Item	Initial value
IP address	192.168.3.1
Subnet mask	255.255.255.0

[Pr. NPA02_IP address]

Supported firmware version				
TSN	CIB	ECT	EIP	—
A0	C0	—	—	—
Initial value		Setting range	Size	
192.168.3.1 (C0A80301h)		Refer to the text	4 bytes	

Set the IP address.

Set each octet to a value between 0 to 255.

In the eight digits of hexadecimal, the first to fourth octets are expressed with each pair of digits.

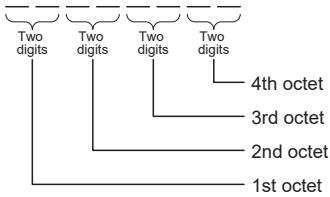

Set the IP address assigned by the network administrator.

Refer to the following for the relation to the rotary switch.

 Page 243 [Pr. NPA01_IP address setting]

When SLMP command (IPAddressSet) is received at the time of IP address delivery from the controller, this network parameter is overwritten with the received IP address.

To enable this network parameter, cycle the power or reset the software after setting.

This network parameter cannot be rewritten via the parameter automatic setting.

[Pr. NPA04_Subnet mask]

Supported firmware version				
TSN	CIB	ECT	EIP	—
A0	C0	—	—	—
Initial value		Setting range	Size	
255.255.255.0 (FFFFFF00h)		Refer to the text	4 bytes	

Set the subnet mask.

Set each octet to a value between 0 to 255.

In the eight digits of hexadecimal, the first to fourth octets are expressed with each pair of digits.

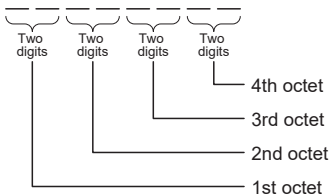

Set the subnet mask assigned by the network administrator.

When SLMP command (IPAddressSet) is received at the time of IP address delivery from the controller, this network parameter is overwritten with the received subnet mask.

To enable this network parameter, cycle the power or reset the software after setting.

This network parameter cannot be rewritten via the parameter automatic setting.

[Pr. NPA08_Host name]

Supported firmware version				
TSN	CIB	ECT	EIP	—
A0	C0	—	—	—
Initial value	Setting range		Size	
0 (All NULL)	63 characters (Refer to the text.)		64 bytes	

Select a host name.

Set a character string of up to 63 characters for the host name.

The characters that can be input as the host name are 0 to 9, A to Z, a to z, hyphen (-), period (.), colon (:), and underscore (_).

This network parameter can be obtained with SLMP command (NodeSearch). The command is "0E30h" and subcommand is "0000h".

This network parameter can be set with SLMP command (IPAddressSet). The command is "0E31h" and subcommand is "0000h".

[Pr. NPA09_Node address setting]

Supported firmware version				
TSN	CIB	ECT	EIP	—
—	—	A5	—	—
Initial value	Setting range		Size	
00000000h	00000000h to 0000FFFFh		4 bytes	

Set the node address of the network.

When using this network parameter, set the ID setting switch to "00h".

[Pr. NPA12_Communication speed]

Supported firmware version				
TSN	CIB	ECT	EIP	—
B6	C0	—	—	—
Initial value	Setting range		Size	
0000002h	Refer to the text		4 bytes	

Set the communication speed.

1: 100 Mbps

2: Network automatic setting

To enable this network parameter, cycle the power or reset the software after setting.

Details of the communication speed are as follows:

[Pr. PN13.0-3 Network protocol setting]	[Pr. NPA12]	Communication speed
0000h (CC-Link IE TSN) (initial value)	2 (initial value)	1 Gbps
0000h (CC-Link IE TSN) (initial value)	1	100 Mbps
0004h (CC-Link IE Field Network Basic) *1	2 (initial value)	100 Mbps
0004h (CC-Link IE Field Network Basic) *1	1	100 Mbps

*1 Available on servo amplifiers with firmware version C0 or later.

5.2 User authentication parameters

[Pr. NPB01_User authentication and authorization setting]

Supported firmware version				
TSN	CIB	ECT	EIP	—
A5	C0	—	E8	—

Initial value	Setting range	Size
00000000h	Refer to the text	4 bytes

Set the connection method to use for setting the user authentication parameter.

To enable this network parameter, cycle the power or reset the software after setting.

When this network parameter is set to "1" (USB only), the user authentication parameter cannot be rewritten via the parameter automatic setting.

Setting value	Authorization	Description
0	Full access possible	The user authentication parameter can be set via either a USB or Ethernet connection.
1	USB only	The user authentication parameter can only be set via a USB connection.

[Pr. NPB04_User name No.1]

Supported firmware version				
TSN	CIB	ECT	EIP	—
A5	C0	—	E8	—

Initial value	Setting range	Size
user	32 characters	36 bytes

Set the user name to use when accessing the FTP server function of the servo amplifier.

Set the user name in accordance with the following restrictions. If a blank (0 character) user name is set, that account will be disabled.

Number of characters	Type of characters
1 to 32	<ul style="list-style-type: none">• Single-byte letters (uppercase)• Single-byte letters (lowercase)• Single-byte numeric characters

If the set user name is identical to an existing account, password and authorization level parameters linked to said user name may be disabled. Ensure that no duplicate user names are set.

[Pr. NPB05_Authorization level No.1]

Supported firmware version				
TSN	CIB	ECT	EIP	—
A5	C0	—	E8	—
Initial value		Setting range	Size	
00000001h		Refer to the text	4 bytes	

Set the authorization level for the user (No.1).

Refer to the following table for details.

Network parameter No.	Setting digit (BIN)	Description
[Pr. NPB05.0]	___x	Firmware update permission selection 0: Prohibited 1: Permitted When "1" (permitted) is set, firmware updates can be performed via the FTP server function.
	__x_	For manufacturer setting
	_x__	Drive recorder data readout permission selection *1 0: Prohibited 1: Permitted When "1" (permitted) is set, readout of the recorded data in the drive recorder can be performed via the FTP server function.
	x___	For manufacturer setting
[Pr. NPB05.1] [Pr. NPB05.2] [Pr. NPB05.3] [Pr. NPB05.4] [Pr. NPB05.5] [Pr. NPB05.6] [Pr. NPB05.7]	For manufacturer setting	For manufacturer setting

*1 Available on servo amplifiers with firmware version B2 or later.

[Pr. NPB06_Password No.1]

Supported firmware version				
TSN	CIB	ECT	EIP	—
A5	C0	—	E8	—
Initial value		Setting range	Size	
user		—	—	

Set the password to use when accessing the FTP server function of the servo amplifier.

Set the password in accordance with the following restrictions.

Number of characters	Type of characters
4 to 32	<ul style="list-style-type: none"> • Single-byte letters (uppercase) • Single-byte letters (lowercase) • Single-byte numeric characters • Special characters <p>"Special characters" refers to the following characters: `~!@#\$%^&*()_+ - = { } ¥ : " ; ' < > ? , . / []` (additionally, a single-byte space can be used).</p>

[Pr. NPB07_User name No.2]

Supported firmware version				
TSN	CIB	ECT	EIP	—
A5	C0	—	E8	—
Initial value		Setting range	Size	
0 (All NULL)		32 characters	36 bytes	

Set the user name (No.2) to use when accessing the FTP server function of the servo amplifier.

☞ Page 246 [Pr. NPB04_User name No.1]

[Pr. NPB08_Authorization level No.2]

Supported firmware version				
TSN	CIB	ECT	EIP	—
A5	C0	—	E8	—
Initial value		Setting range	Size	
00000000h		Refer to the text	4 bytes	

Set the authorization level for the user (No.2).

☞ Page 247 [Pr. NPB05_Authorization level No.1]

[Pr. NPB09_Password No.2]

Supported firmware version				
TSN	CIB	ECT	EIP	—
A5	C0	—	E8	—
Initial value		Setting range	Size	
—		—	—	

Set the password (No.2) to use when accessing the FTP server function of the servo amplifier.

☞ Page 247 [Pr. NPB06_Password No.1]

[Pr. NPB10_User name No.3]

Supported firmware version				
TSN	CIB	ECT	EIP	—
A5	C0	—	E8	—
Initial value		Setting range	Size	
0 (All NULL)		32 characters	36 bytes	

Set the user name (No.3) to use when accessing the FTP server function of the servo amplifier.

☞ Page 246 [Pr. NPB04_User name No.1]

[Pr. NPB11_Authorization level No.3]

Supported firmware version				
TSN	CIB	ECT	EIP	—
A5	C0	—	E8	—
Initial value		Setting range	Size	
00000000h		Refer to the text	4 bytes	

Set the authorization level for the user (No.3).

☞ Page 247 [Pr. NPB05_Authorization level No.1]

[Pr. NPB12_Password No.3]

Supported firmware version				
TSN	CIB	ECT	EIP	—
A5	C0	—	E8	—
Initial value		Setting range	Size	
—		—	—	

Set the password (No.3) to use when accessing the FTP server function of the servo amplifier.

☞ Page 247 [Pr. NPB06_Password No.1]

[Pr. NPB13_User name No.4]

Supported firmware version				
TSN	CIB	ECT	EIP	—
A5	C0	—	E8	—
Initial value		Setting range	Size	
0 (All NULL)		32 characters	36 bytes	

Set the user name (No.4) to use when accessing the FTP server function of the servo amplifier.

☞ Page 246 [Pr. NPB04_User name No.1]

[Pr. NPB14_Authorization level No.4]

Supported firmware version				
TSN	CIB	ECT	EIP	—
A5	C0	—	E8	—
Initial value		Setting range	Size	
00000000h		Refer to the text	4 bytes	

Set the authorization level for the user (No.4).

☞ Page 247 [Pr. NPB05_Authorization level No.1]

[Pr. NPB15_Password No.4]

Supported firmware version				
TSN	CIB	ECT	EIP	—
A5	C0	—	E8	—
Initial value		Setting range	Size	
—		—	—	

Set the password (No.4) to use when accessing the FTP server function of the servo amplifier.

☞ Page 247 [Pr. NPB06_Password No.1]

[Pr. NPB16_User name No.5]

Supported firmware version				
TSN	CIB	ECT	EIP	—
A5	C0	—	E8	—
Initial value		Setting range	Size	
0 (All NULL)		32 characters	36 bytes	

Set the user name (No.5) to use when accessing the FTP server function of the servo amplifier.

☞ Page 246 [Pr. NPB04_User name No.1]

[Pr. NPB17_ Authorization level No.5]

Supported firmware version				
TSN	CIB	ECT	EIP	—
A5	C0	—	E8	—
Initial value		Setting range	Size	
00000000h		Refer to the text	4 bytes	

Set the authorization level for the user (No.5).

☞ Page 247 [Pr. NPB05_ Authorization level No.1]

[Pr. NPB18_ Password No.5]

Supported firmware version				
TSN	CIB	ECT	EIP	—
A5	C0	—	E8	—
Initial value		Setting range	Size	
—		—	—	

Set the password (No.5) to use when accessing the FTP server function of the servo amplifier.

☞ Page 247 [Pr. NPB06_ Password No.1]

[Pr. NPB19_ User name No.6]

Supported firmware version				
TSN	CIB	ECT	EIP	—
A5	C0	—	E8	—
Initial value		Setting range	Size	
0 (All NULL)		32 characters	36 bytes	

Set the user name (No.6) to use when accessing the FTP server function of the servo amplifier.

☞ Page 246 [Pr. NPB04_ User name No.1]

[Pr. NPB20_ Authorization level No.6]

Supported firmware version				
TSN	CIB	ECT	EIP	—
A5	C0	—	E8	—
Initial value		Setting range	Size	
00000000h		Refer to the text	4 bytes	

Set the authorization level for the user (No.6).

☞ Page 247 [Pr. NPB05_ Authorization level No.1]

[Pr. NPB21_ Password No.6]

Supported firmware version				
TSN	CIB	ECT	EIP	—
A5	C0	—	E8	—
Initial value		Setting range	Size	
—		—	—	

Set the password (No.6) to use when accessing the FTP server function of the servo amplifier.

☞ Page 247 [Pr. NPB06_ Password No.1]

[Pr. NPB22_User name No.7]

Supported firmware version				
TSN	CIB	ECT	EIP	—
A5	C0	—	E8	—
Initial value		Setting range	Size	
0 (All NULL)		32 characters	36 bytes	

Set the user name (No.7) to use when accessing the FTP server function of the servo amplifier.

☞ Page 246 [Pr. NPB04_User name No.1]

[Pr. NPB23_Authorization level No.7]

Supported firmware version				
TSN	CIB	ECT	EIP	—
A5	C0	—	E8	—
Initial value		Setting range	Size	
00000000h		Refer to the text	4 bytes	

Set the authorization level for the user (No.7).

☞ Page 247 [Pr. NPB05_Authorization level No.1]

[Pr. NPB24_Password No.7]

Supported firmware version				
TSN	CIB	ECT	EIP	—
A5	C0	—	E8	—
Initial value		Setting range	Size	
—		—	—	

Set the password (No.7) to use when accessing the FTP server function of the servo amplifier.

☞ Page 247 [Pr. NPB06_Password No.1]

[Pr. NPB25_User name No.8]

Supported firmware version				
TSN	CIB	ECT	EIP	—
A5	C0	—	E8	—
Initial value		Setting range	Size	
0 (All NULL)		32 characters	36 bytes	

Set the user name (No.8) to use when accessing the FTP server function of the servo amplifier.

☞ Page 246 [Pr. NPB04_User name No.1]

[Pr. NPB26_Authorization level No.8]

Supported firmware version				
TSN	CIB	ECT	EIP	—
A5	C0	—	E8	—
Initial value		Setting range	Size	
00000000h		Refer to the text	4 bytes	

Set the authorization level for the user (No.8).

☞ Page 247 [Pr. NPB05_Authorization level No.1]

[Pr. NPB27_Password No.8]

Supported firmware version				
TSN	CIB	ECT	EIP	—
A5	C0	—	E8	—
Initial value		Setting range		Size
—		—		—

Set the password (No.8) to use when accessing the FTP server function of the servo amplifier.

☞ Page 247 [Pr. NPB06_Password No.1]

5.3 EtherNet/IP setting parameters

[Pr. NPC01_Configuration Control]

Supported firmware version				
TSN	CIB	ECT	EIP	—
—	—	—	E8	—

Initial value	Setting range	Size
2	Refer to the text	4 bytes

Set the IP address required for communication.

To enable this network parameter, cycle the power or reset the software after setting.

If the IP address is set in the "Change IP Address of Servo Amplifiers" window of MR Configurator2, the IP address is written to [Pr. NPC02]. At this time, "0" (The network parameter is used) is automatically written to the setting value of this network parameter, and the set IP address is enabled without cycling the power or resetting the software.

If the IP address is changed by this method when the servo amplifier is connected to a multi-axis project in MR Configurator2, the communication with MR Configurator2 is disconnected. Connect it to MR Configurator2 again.

When the setting value is written to [Configuration Control (Class ID: F5h, Ins ID: 01h, Attr ID: 03h)] of "TCP/IP Interface Object" and DHCP is enabled, this network parameter is set to "2" (DHCP is used) and enabled without cycling the power or resetting the software.

When DHCP is disabled, this network parameter is set to "0" (The network parameter is used) and enabled without cycling the power or resetting the software.

Refer to the following table for the combinations of the rotary switch setting and setting values.

Rotary switch (SW2/SW3)	Setting value	IP address	
00h	—	1st octet	Acquired from the DHCP server. The IP address acquired from the DHCP server is stored in [Pr. NPC02].
		2nd octet	
		3rd octet	
		4th octet	
01h	0: The network parameter is used.	1st octet	The 1st octet of the setting value in [Pr. NPC02] is used.
		2nd octet	The 2nd octet of the setting value in [Pr. NPC02] is used.
		3rd octet	The 3rd octet of the setting value in [Pr. NPC02] is used.
		4th octet	The 4th octet of the setting value in [Pr. NPC02] is used.
	1: For manufacturer setting	—	For manufacturer setting
	2: DHCP is used.	1st octet	Acquired from the DHCP server. The IP address acquired from the DHCP server is stored in [Pr. NPC02].
		2nd octet	
		3rd octet	
4th octet			
02h to FEh	—	1st octet	The 1st octet of the setting value in [Pr. NPC02] is used.
		2nd octet	The 2nd octet of the setting value in [Pr. NPC02] is used.
		3rd octet	The 3rd octet of the setting value in [Pr. NPC02] is used.
		4th octet	The setting value of the rotary switch (SW2/SW3) is used.
FFh	—	1st octet	For manufacturer setting
		2nd octet	
		3rd octet	
		4th octet	

The initial value of the IP address is as follows.

Item	Initial value
IP address	192.168.1.1
Subnet mask	255.255.255.0
Default gateway	0.0.0.0

[Pr. NPC02_IP Address]

Supported firmware version				
TSN	CIB	ECT	EIP	—
—	—	—	E8	—

Initial value	Setting range	Size
192.168.1.1 (C0A80101h)	Refer to the text	4 bytes

Set the IP address.

Set each octet to a value between 0 to 255.

In the eight digits of hexadecimal, the first to fourth octets are expressed with each pair of digits.

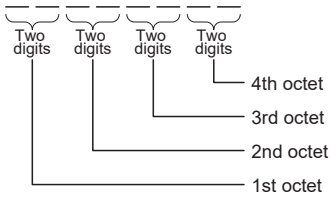

Set the IP address assigned by the network administrator.

Refer to the following for the relation to the rotary switch.

☞ Page 253 [Pr. NPC01_Configuration Control]

To enable this network parameter, cycle the power or reset the software after setting.

When the IP address is specified by any of the following operations, this network parameter is overwritten, and the IP address after the change is enabled without cycling the power or resetting the software.

- Acquiring the IP address from the DHCP server
- Writing the IP address to [Configuration Control (Class ID: F5h, Ins ID: 01h, Attr ID: 05h)] of "TCP/IP Interface Object"

Setting the IP address to any of the following triggers [AL. 037 Parameter error].

- "0.0.0.0"
- "127.0.0.0" to "127.255.255.255"
- "224.0.0.0" to "239.255.255.255"
- A broadcast address
- A network address

[Pr. NPC03_Network Mask]

Supported firmware version				
TSN	CIB	ECT	EIP	—
—	—	—	E8	—

Initial value	Setting range	Size
255.255.255.0 (FFFFFF00h)	Refer to the text	4 bytes

Set the subnet mask.

Set each octet to a value between 0 to 255.

In the eight digits of hexadecimal, the first to fourth octets are expressed with each pair of digits.

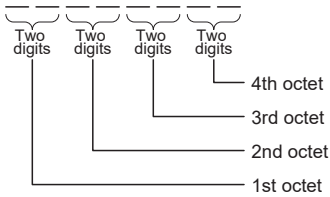

Set the subnet mask assigned by the network administrator.

To enable this network parameter, cycle the power or reset the software after setting.

When the subnet mask is specified by any of the following operations, this network parameter is overwritten, and the subnet mask after the change is enabled without cycling the power or resetting the software.

- Acquiring the subnet mask from the DHCP server
- Writing the IP address to [Configuration Control (Class ID: F5h, Ins ID: 01h, Attr ID: 05h)] of "TCP/IP Interface Object"

An incorrect setting value of the subnet mask triggers [AL. 037 Parameter error] occurs.

[Pr. NPC04_Gateway Address]

Supported firmware version				
TSN	CIB	ECT	EIP	—
—	—	—	E8	—

Initial value	Setting range	Size
0.0.0.0 (00000000h)	Refer to the text	4 bytes

Set the default gateway.

Set each octet to a value between 0 to 255.

In the eight digits of hexadecimal, the first to fourth octets are expressed with each pair of digits.

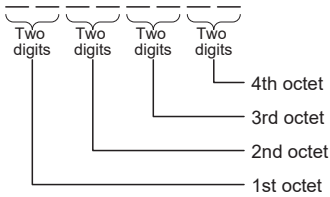

The initial value "0.0.0.0" indicates that the default gateway is disabled.

Set the default gateway assigned by the network administrator.

To enable this network parameter, cycle the power or reset the software after setting.

When the default gateway is specified by any of the following operations, this network parameter is overwritten and the default gateway after the change is enabled without cycling the power or resetting the software.

- Acquiring the default gateway from the DHCP server
- Writing the IP address to [Configuration Control (Class ID: F5h, Ins ID: 01h, Attr ID: 05h)] of "TCP/IP Interface Object"

Configuring any of the following settings triggers [AL. 037 Parameter error] and disables the default gateway.

- "127.0.0.0" to "127.255.255.255"
- "224.0.0.0" to "239.255.255.255"
- A broadcast address
- A network address
- Different values in this network parameter and the network address in [Pr. NPC02 IP Address]

[Pr. NPC05_Interface Control Port1]

Supported firmware version				
TSN	CIB	ECT	EIP	—
—	—	—	E8	—
Initial value		Setting range		Size
00000002h		Refer to the text		4 bytes

Set the communication speed of Port1 (CN1B).

2h: Auto-negotiate

3h: For manufacturer setting

4h: For manufacturer setting

5h: For manufacturer setting

6h: 100 Mbps Full Duplex

7h: 100 Mbps Half Duplex

8h: For manufacturer setting

9h: 10 Mbps Full Duplex

Ah: 10 Mbps Half Duplex

If any of the following operations is performed, cycle the power or reset the software after setting to enable this network parameter.

- Changing this network parameter from the engineering software
- Writing data to [Interface Control (Class ID: F6h, Ins ID: 01h, Attr ID: 06h)] of "Ethernet Link Object" and changing the setting value of this network parameter

Changing the setting value for manufacturer setting triggers [AL. 037 Parameter error]. At this time, the communication speed becomes the same as the one when "2h" (Auto-negotiate) is set.

[Pr. NPC06_Interface Control Port2]

Supported firmware version				
TSN	CIB	ECT	EIP	—
—	—	—	E8	—
Initial value		Setting range		Size
00000002h		Refer to the text		4 bytes

Set the communication speed of Port2 (CN1A).

2h: Auto-negotiate

3h: For manufacturer setting

4h: For manufacturer setting

5h: For manufacturer setting

6h: 100 Mbps Full Duplex

7h: 100 Mbps Half Duplex

8h: For manufacturer setting

9h: 10 Mbps Full Duplex

Ah: 10 Mbps Half Duplex

If any of the following operations is performed, cycle the power or reset the software after setting to enable this network parameter.

- Changing this network parameter from the engineering software
- Writing data to [Interface Control (Class ID: F6h, Ins ID: 01h, Attr ID: 06h)] of "Ethernet Link Object" and changing the setting value of this network parameter

Changing the setting value for manufacturer setting triggers [AL. 037 Parameter error]. At this time, the communication speed becomes the same as the one when "2h" (Auto-negotiate) is set.

6 NETWORK PARAMETER SETTING METHOD

6.1 Engineering software

The network parameters can be set with MR Configurator2. Connect a personal computer and the servo amplifier via a USB cable or a network. For details on how to set network parameters, refer to Help or the manual for the engineering software.

7 FUNCTIONAL SAFETY PARAMETER DETAILS

Restrictions

Settable functional safety parameters and values depend on the servo amplifier firmware version and MR Configurator2 software version. Refer to the Mitsubishi Electric FA site for the latest software version of MR Configurator2. In addition, the firmware version of the servo amplifier can be checked with MR Configurator2, objects, or by other means. When using servo motors with functional safety, executing software reset may trigger [AL. 016 Encoder initial communication error 1]. If [AL. 016] occurs, cycle the power.

Precautions

Do not change the functional safety parameter settings as described below. Doing so may cause an unexpected condition, such as failing to start up the servo amplifier.

- Changing the values of the functional safety parameters for manufacturer setting
- Setting a value outside the range
- Changing the fixed value in each functional safety parameter

"" added to functional safety parameter abbreviations means the following.

** : After setting, cycle the power or reset the software.

7.1 Safety sub-function 1 parameters group ([Pr. PSA_ _])

[Pr. PSA01_Safety sub-function mode selection (**SOA)]

Initial value	Setting range	Setting method	Ver.
00000000h	Refer to the relevant detail No.	Common	Refer to the relevant detail No.

Set the safety sub-function.

[Pr. PSA01.0_Safety sub-function activation setting]

Initial value	Setting range	Ver.
0h	Refer to the text	B2

0: Disabled

1: Enabled

When setting this functional safety parameter to "1" (enabled), check the setting of each relevant parameter for problems. When the functional safety parameter is set to "0" (disabled) on servo amplifiers other than the MR-J5-_G_-HS_, only the STO function with the CN8 connector can be used.

[Pr. PSA01.1_Input mode selection]

Initial value	Setting range	Ver.
0h	Refer to the text	B2

0: Safety sub-function control by input device

1: Safety sub-function control by network

2: Test operation

When setting this functional safety parameter to "2" (test operation), the safety sub-function is not available.

For information regarding test operation, refer to "Test operation" in the User's Manual (Introduction).

If this functional safety parameter is set incorrectly, [AL. 537 Parameter setting range error (safety sub-function)] occurs.

Setting "1" with a servo amplifier that cannot use the safety sub-function control by network triggers [AL. 537]. For availability of the safety sub-function control by network, refer to "List of safety sub-function compatible units" in the User's Manual (Introduction).

[Pr. PSA02_Functional safety setting (**SMD)]

Initial value	Setting range	Setting method	Ver.
00000000h	Refer to the relevant detail No.	Each axis	Refer to the relevant detail No.

[Pr. PSA02.1_Position/Speed monitor setting]

Initial value	Setting range	Ver.
0h	Refer to the text	B2

0: Do not monitor the position/speed.

1: Monitor the position/speed using a servo motor with functional safety.

2: Monitor the speed without using a servo motor with functional safety.

If this functional safety parameter is set incorrectly, [AL. 537 Parameter setting range error (safety sub-function)] occurs.

[Pr. PSA02.2_Time/Deceleration monitor setting]

Initial value	Setting range	Ver.
0h	Refer to the text	B2

0: Perform time monitoring (SS1) and deceleration stop monitoring/stop monitoring (SS2/SOS).

1: Perform deceleration monitoring in addition to time monitoring (SS1) and deceleration stop monitoring/stop monitoring (SS2/SOS).

If this functional safety parameter is set incorrectly, [AL. 537 Parameter setting range error (safety sub-function)] occurs.

[Pr. PSA02.3_Operation mode selection]

Initial value	Setting range	Ver.
0h	Refer to the text	B2

0: Standard control mode

4: Linear servo motor control mode

6: Direct drive motor control mode

If [Pr. PSA02.1 Position/Speed monitor setting] is not set to "0" (do not monitor the position/speed), set this servo parameter to the same value as [Pr. PA01.1 Operation mode selection]. If this functional safety parameter is set incorrectly, [AL. 537 Parameter setting range error (safety sub-function)] occurs.

[Pr. PSA03_SS1/SS2 deceleration monitor time (**SST)]

Initial value	Setting range	Setting method	Ver.
1000 [ms]	0 to 60000	Each axis	B2

Set the deceleration time for the SS1 function and the SS2/SOS function. This functional safety parameter is used by the following two functions.

- The STO function activates when the time set in this functional safety parameter elapses when decelerating while using the SS1 function.
- When using the SS2/SOS function, the deceleration stop monitoring shifts to the stop monitoring (SOS) when the time set in this functional safety parameter elapses while decelerating.

[Pr. PSA04_Safety sub-function - Stop speed (**SSS)]

Initial value	Setting range	Setting method	Ver.
50 [r/min], [mm/s]	0 to 10000	Each axis	B2

Set the stop speed. If the absolute value of the servo motor speed is equal to or less than the value set in this functional safety parameter, the SS2/SOS function considers the servo motor as being stopped.

This functional safety parameter is used by the following four functions.

- When using the SS2/SOS function, the deceleration stop monitoring shifts to the stop monitoring (SOS) when the deceleration speed becomes equal to or less than the servo motor speed set in this functional safety parameter.
- When using the SS2/SOS function, the STO function activates if the deceleration speed during the stop monitoring (SOS) exceeds the servo motor speed set in this functional safety parameter.
- When using the SS1 function, the STO function activates if the deceleration speed during deceleration monitoring becomes equal to or less than the servo motor speed set in this functional safety parameter.
- When using the SD1 function, the STO function activates if movement counter to the travel direction specified in SDIP or SDIN occurs during direction monitoring due to the servo motor speed set in this functional safety parameter.

[Pr. PSA05_SOS permissible travel distance (**SSDP)]

Initial value	Setting range	Setting method	Ver.	
			J5G	J5G-N1
3 [rev]	0 to 1000	Each axis	B2	D8

Specify the travel distance to be permitted during stop monitoring (SOS) via the SS2/SOS function. The STO function activates if movement to a position exceeding the position set in this functional safety parameter occurs after stop monitoring starts.

The setting unit can be changed with [Pr. PSA06 SOS permissible travel distance unit selection].

This functional safety parameter can be used with the MR-J5-_G_-RJ_, MR-J5-_G_-HS_, MR-J5W_-_G_, and MR-J5D_-_G_. For MR-J5W_-_G_, this functional safety parameter is available on servo amplifiers with firmware version D8 or later.

[Pr. PSA06_SOS permissible travel distance unit selection (**SAOP1)]

Initial value	Setting range	Setting method	Ver.
00000000h	Refer to the relevant detail No.	Each axis	Refer to the relevant detail No.

Select the setting unit that will be used to set the SOS permissible travel distance in [Pr. PSA05 SOS permissible travel distance].

[Pr. PSA06.0_SOS permissible travel distance unit selection]

Initial value	Setting range	Ver.	
		J5G	J5G-N1
0h	Refer to the text	B2	D8

0: [rev]

1: [0.1 rev]

2: [0.01 rev]

This functional safety parameter can be used with the MR-J5-_G_-RJ_, MR-J5-_G_-HS_, MR-J5W_-_G_, and MR-J5D_-_G_. For MR-J5W_-_G_, this functional safety parameter is available on servo amplifiers with firmware version D8 or later.

[Pr. PSA07_SLS deceleration monitor time 1 (**SLSDT1)]

Initial value	Setting range	Setting method	Ver.	
			J5G	J5G-N1
1000 [ms]	0 to 60000	Each axis	B2	D8

Set the threshold for the time required for the speed monitoring to start after the SLS1 command is enabled. Specify a sufficient time that allows for deceleration to the safety speed after the SLS1 command is enabled. Perform deceleration control from the controller, etc. as necessary during this delay time.

This functional safety parameter can be used with the MR-J5-_G_-RJ_, MR-J5-_G_-HS_, MR-J5W_-_G_, and MR-J5D_-_G_. For MR-J5W_-_G_, this functional safety parameter is available on servo amplifiers with firmware version D8 or later.

[Pr. PSA08_SLS deceleration monitor time 2 (**SLSDT2)]

Initial value	Setting range	Setting method	Ver.	
			J5G	J5G-N1
1000 [ms]	0 to 60000	Each axis	B2	D8

Set the threshold for the time required for the speed monitoring to start after the SLS2 command is enabled. Specify a sufficient time that allows for deceleration to the safety speed after the SLS2 command is enabled. Perform deceleration control from the controller, etc. as necessary during this delay time.

This functional safety parameter can be used with the MR-J5-_G_-RJ_, MR-J5-_G_-HS_, MR-J5W_-_G_, and MR-J5D_-_G_. For MR-J5W_-_G_, this functional safety parameter is available on servo amplifiers with firmware version D8 or later.

[Pr. PSA09_SLS deceleration monitor time 3 (**SLSDT3)]

Initial value	Setting range	Setting method	Ver.	
			J5G	J5G-N1
1000 [ms]	0 to 60000	Each axis	B2	D8

Set the threshold for the time required for the speed monitoring to start after the SLS3 command is enabled. Specify a sufficient time that allows for deceleration to the safety speed after the SLS3 command is enabled. Perform deceleration control from the controller, etc. as necessary during this delay time.

This functional safety parameter can be used with the MR-J5-_G_-RJ_, MR-J5-_G_-HS_, MR-J5W_-_G_, and MR-J5D_-_G_. For MR-J5W_-_G_, this functional safety parameter is available on servo amplifiers with firmware version D8 or later.

[Pr. PSA10_SLS deceleration monitor time 4 (**SLSDT4)]

Initial value	Setting range	Setting method	Ver.	
			J5G	J5G-N1
1000 [ms]	0 to 60000	Each axis	B2	D8

Set the threshold for the time required for the speed monitoring to start after the SLS4 command is enabled. Specify a sufficient time that allows for deceleration to the safety speed after the SLS4 command is enabled. Perform deceleration control from the controller, etc. as necessary during this delay time.

This functional safety parameter can be used with the MR-J5-_G_-RJ_, MR-J5-_G_-HS_, MR-J5W_-_G_, and MR-J5D_-_G_. For MR-J5W_-_G_, this functional safety parameter is available on servo amplifiers with firmware version D8 or later.

[Pr. PSA11_SLS speed 1 (**SLSS1)]

Initial value	Setting range	Setting method	Ver.	
			J5G	J5G-N1
50 [r/min], [mm/s]	0 to 10000	Each axis	B2	D8

Set the threshold for the safety speed if activating the SLS function via the SLS1 command. The STO function will activate if the absolute value of the servo motor speed exceeds the value set in this parameter during speed monitoring via the SLS function.

This functional safety parameter can be used with the MR-J5-_G_-RJ_, MR-J5-_G_-HS_, MR-J5W_-_G_, and MR-J5D_-_G_. For MR-J5W_-_G_, this functional safety parameter is available on servo amplifiers with firmware version D8 or later.

[Pr. PSA12_SLS speed 2 (**SLSS2)]

Initial value	Setting range	Setting method	Ver.	
			J5G	J5G-N1
50 [r/min], [mm/s]	0 to 10000	Each axis	B2	D8

Set the threshold for the safety speed if activating the SLS function via the SLS2 command. The STO function will activate if the absolute value of the servo motor speed exceeds the value set in this parameter during speed monitoring via the SLS function.

This functional safety parameter can be used with the MR-J5-_G_-RJ_, MR-J5-_G_-HS_, MR-J5W_-_G_, and MR-J5D_-_G_. For MR-J5W_-_G_, this functional safety parameter is available on servo amplifiers with firmware version D8 or later.

[Pr. PSA13_SLS speed 3 (**SLSS3)]

Initial value	Setting range	Setting method	Ver.	
			J5G	J5G-N1
50 [r/min], [mm/s]	0 to 10000	Each axis	B2	D8

Set the threshold for the safety speed if activating the SLS function via the SLS3 command. The STO function will activate if the absolute value of the servo motor speed exceeds the value set in this parameter during speed monitoring via the SLS function.

This functional safety parameter can be used with the MR-J5-_G_-RJ_, MR-J5-_G_-HS_, MR-J5W_-_G_, and MR-J5D_-_G_. For MR-J5W_-_G_, this functional safety parameter is available on servo amplifiers with firmware version D8 or later.

[Pr. PSA14_SLS speed 4 (**SLSS4)]

Initial value	Setting range	Setting method	Ver.	
			J5G	J5G-N1
50 [r/min], [mm/s]	0 to 10000	Each axis	B2	D8

Set the threshold for the safety speed if activating the SLS function via the SLS4 command. The STO function will activate if the absolute value of the servo motor speed exceeds the value set in this parameter during speed monitoring via the SLS function.

This functional safety parameter can be used with the MR-J5-_G_-RJ_, MR-J5-_G_-HS_, MR-J5W_-_G_, and MR-J5D_-_G_. For MR-J5W_-_G_, this functional safety parameter is available on servo amplifiers with firmware version D8 or later.

[Pr. PSA15_Safety sub-function - Speed detection delay time (**SLST)]

Initial value	Setting range	Setting method	Ver.	
10 [ms]	5 to 2000	Each axis	B2	

Specify the filter time of the delay filter that will judge whether the servo motor speed has exceeded or fallen below the threshold during speed monitoring. The setting of this functional safety parameter delays the response time of the following types of speed monitoring.

- The time required for the STO function to start after the speed is exceeded during speed monitoring via the SLS function
- The time required for the stop monitoring (SOS) to start after the servo motor speed falls below the stop speed while decelerating during deceleration monitoring via the SS2/SOS function
- The time required for the STO function to start after the servo motor speed exceeds the stop speed during stop monitoring (SOS) via the SS2/SOS function
- The time required for the STO function to start after the deceleration speed either exceeds the deceleration monitor speed or falls below the stop speed during deceleration monitoring via the SS1 function

[Pr. PSA17_Safety sub-function - Position detection delay time (**SOSPT)]

Initial value	Setting range	Setting method	Ver.	
			J5G	J5G-N1
0 [ms]	0 to 2000	Each axis	B2	D8

Specify the filter time of the delay filter that will judge whether the motor position has exceeded the threshold during position monitoring. The setting of this functional safety parameter delays the response time of the following types of position monitoring.

- The time required for the STO function to start after the position feedback travel distance deviates from the permissible travel distance during stop monitoring via the SS2/SOS function

This functional safety parameter can be used with the MR-J5-_G_-RJ_, MR-J5-_G_-HS_, MR-J5W_-_G_, and MR-J5D_-_G_. For MR-J5W_-_G_, this functional safety parameter is available on servo amplifiers with firmware version D8 or later.

[Pr. PSA18_SSM speed (**SSMS)]

Initial value	Setting range	Setting method	Ver.	
			J5G	J5G-N1
50 [r/min], [mm/s]	0 to 10000	Each axis	B2	D8

Set the threshold for the safety speed if activating the SSM function. SSMS (SSM output) turns off when the absolute value of the servo motor speed exceeds this speed, and turns on when the absolute value of the servo motor speed falls below this speed. Note that judgment of the absolute value of the servo motor speed uses the hysteresis specified in [Pr. PSA19 SSM hysteresis width].

SSMS (SSM output) is turned off if an alarm that disables the safety sub-function occurs.

If this functional safety parameter is set incorrectly, [AL. 537 Parameter setting range error (safety sub-function)] occurs.

This functional safety parameter can be used with the MR-J5-_G_-RJ_, MR-J5-_G_-HS_, MR-J5W_-_G_, and MR-J5D_-_G_. For MR-J5W_-_G_, this functional safety parameter is available on servo amplifiers with firmware version D8 or later.

[Pr. PSA19_SSM hysteresis width (**SSMHW)]

Initial value	Setting range	Setting method	Ver.	
			J5G	J5G-N1
20 [r/min], [mm/s]	0 to 10000	Each axis	B2	D8

Set the threshold of the hysteresis width for SSM speed judgment. Ensure that the value set in this parameter is smaller than the value set in [Pr. PSA18 SSM speed].

If this parameter is set to a value larger than the value set in [Pr. PSA18], [AL. 537 Parameter setting range error (safety sub-function)] occurs.

If this functional safety parameter is set incorrectly, [AL. 537] occurs.

This functional safety parameter can be used with the MR-J5-_G_-RJ_, MR-J5-_G_-HS_, MR-J5W_-_G_, and MR-J5D_-_G_. For MR-J5W_-_G_, this functional safety parameter is available on servo amplifiers with firmware version D8 or later.

[Pr. PSA20_Servo motor encoder resolution (**SMER)]

Initial value	Setting range	Setting method	Ver.
67108864 [pulse/rev]	0 to 4294967295	Each axis	B2

Set the encoder resolution of the servo motor. There is no need to set this functional safety parameter when using a linear servo motor. It is necessary to set [Pr. PSL02 Functional safety - Linear encoder resolution setting - Numerator] and [Pr. PSL03 Functional safety - Linear encoder resolution setting - Denominator], however.

If the value set in this functional safety parameter does not match the actual resolution of the connected encoder, [AL. 537 Parameter setting range error (safety sub-function)] occurs.

If this functional safety parameter is set incorrectly, [AL. 537] occurs.

[Pr. PSA22_Position feedback error detection time (**SAADT)]

Initial value	Setting range	Setting method	Ver.
60 [min]	0 to 65535	Each axis	B2

Set the time required for detection of [AL. 52A Position feedback error (safety sub-function)].

The time required to detect a position feedback diagnosis error when a standard encoder is used will be set.

Diagnosis via [AL. 52A] is not executed if this parameter is set to "0".

[Pr. PSA23_Servo motor rated speed (**SMRS)]

Initial value	Setting range	Setting method	Ver.
3000 [r/min], [mm/s]	0 to 10000	Each axis	B2

Set the servo motor rated speed. This functional safety parameter converts the values from [Pr. PSA24 SS1/SS2 deceleration monitor time constant], etc. into acceleration.

Be sure to set the rated speed of the connected servo motor. If the rated speed set in this functional safety parameter does not match the actual rated speed of the connected servo motor, [AL. 537 Parameter setting range error (safety sub-function)] occurs.

[Pr. PSA24_SS1/SS2 deceleration monitor time constant (**SSTC)]

Initial value	Setting range	Setting method	Ver.
100 [ms]	0 to 20000	Each axis	B2

Set the deceleration time constant for the SS1 function and the SS2/SOS function. The STO function activates if the speed does not conform to the deceleration time constant set in this functional safety parameter after deceleration monitoring starts.

[Pr. PSA25_SS1/SS2 deceleration monitor speed offset (**SSOF)]

Initial value	Setting range	Setting method	Ver.
0 [r/min], [mm/s]	0 to 10000	Each axis	B2

Set the monitor speed offset for [Pr. PSA24 SS1/SS2 deceleration monitor time constant].

Use this parameter if overshoot occurs at the start of deceleration, etc.

[Pr. PSA26_SS1/SS2 deceleration monitor delay time (**SSDT)]

Initial value	Setting range	Setting method	Ver.
100 [ms]	0 to 60000	Each axis	B2

Set the threshold for the time required for the deceleration monitoring to start after the SS1 command or SS2 command is enabled. Specify a time that is sufficient for deceleration to start after the SS1 command or SS2 command is enabled.

[Pr. PSA27_SDI positive direction monitor delay time (**SDIDTP)]

Initial value	Setting range	Setting method	Ver.	
			J5G	J5G-N1
1000 [ms]	0 to 60000	Each axis	B2	D8

Set the time required for the direction monitoring to start after the SDIP command is enabled. Specify a time that is sufficient for the travel direction of the servo motor to change to the negative direction after the SDIP command is enabled.

This functional safety parameter can be used with the MR-J5-_G_-RJ_, MR-J5-_G_-HS_, MR-J5W_-_G_, and MR-J5D_-_G_. For MR-J5W_-_G_, this functional safety parameter is available on servo amplifiers with firmware version D8 or later.

[Pr. PSA28_SDI negative direction monitor delay time (**SDIDTN)]

Initial value	Setting range	Setting method	Ver.	
			J5G	J5G-N1
1000 [ms]	0 to 60000	Each axis	B2	D8

Set the time required for the direction monitoring to start after the SDIN command is enabled. Specify a time that is sufficient for the travel direction of the servo motor to change to the positive direction after the SDIN command is enabled.

This functional safety parameter can be used with the MR-J5-_G_-RJ_, MR-J5-_G_-HS_, MR-J5W_-_G_, and MR-J5D_-_G_. For MR-J5W_-_G_, this functional safety parameter is available on servo amplifiers with firmware version D8 or later.

7.2 Safety sub-function 2 parameters group ([Pr. PSB_ _])

[Pr. PSB01_SLI permissible travel distance - Unit selection (**SLIPUS)]

Initial value	Setting range	Setting method	Ver.
00000000h	Refer to the relevant detail No.	Each axis	Refer to the relevant detail No.

Select the setting unit for the SLI permissible travel distance.

[Pr. PSB01.0_SLI permissible travel distance - Unit selection 1]

Initial value	Setting range	Ver.	
		J5G	J5G-N1
0h	Refer to the text	B2	D8

0: [rev]

1: [0.1 rev]

2: [0.01 rev]

This functional safety parameter can be used with the MR-J5-_G_-RJ_, MR-J5-_G_-HS_, MR-J5W_-_G_, and MR-J5D_-_G_. For MR-J5W_-_G_, this functional safety parameter is available on servo amplifiers with firmware version D8 or later.

[Pr. PSB02_SLI permissible travel distance - Positive direction 1 (**SLIPP1)]

Initial value	Setting range	Setting method	Ver.	
			J5G	J5G-N1
3 [rev]	0 to 1000	Each axis	B2	D8

Set the positive direction travel distance to be permitted during travel distance monitoring via the SLI function. The STO function activates if movement exceeding the travel distance set in this functional safety parameter occurs after travel distance monitoring starts.

The setting unit can be changed with [Pr. PSB01.0 SLI permissible travel distance - Unit selection 1].

This functional safety parameter can be used with the MR-J5-_G_-RJ_, MR-J5-_G_-HS_, MR-J5W_-_G_, and MR-J5D_-_G_. For MR-J5W_-_G_, this functional safety parameter is available on servo amplifiers with firmware version D8 or later.

[Pr. PSB06_SLI permissible travel distance - Negative direction 1 (**SLIPN1)]

Initial value	Setting range	Setting method	Ver.	
			J5G	J5G-N1
3 [rev]	0 to 1000	Each axis	B2	D8

Set the negative direction travel distance to be permitted during travel distance monitoring via the SLI function. The STO function activates if movement exceeding the travel distance set in this functional safety parameter occurs after travel distance monitoring starts.

The setting unit can be changed with [Pr. PSB01.0 SLI permissible travel distance - Unit selection 1].

This functional safety parameter can be used with the MR-J5-_G_-RJ_, MR-J5-_G_-HS_, MR-J5W_-_G_, and MR-J5D_-_G_. For MR-J5W_-_G_, this functional safety parameter is available on servo amplifiers with firmware version D8 or later.

[Pr. PSB10_SLT torque upper limit value 1 (**SLTP1)]

Initial value	Setting range	Setting method	Ver.	
			J5G	J5G-N1
15.0 [%]	-1000.0 to 1000.0	Each axis	B2	D8

Set the upper limit threshold for the safety torque if activating the SLT function via the SLT1 command.

The STO function will activate if the torque exceeds the threshold during torque monitoring via the SLT function.

Ensure that the value set in this parameter is larger than the value set in [Pr. PSB14 SLT torque lower limit value 1]. If this functional safety parameter is set incorrectly, [AL. 537 Parameter setting range error (safety sub-function)] occurs.

This functional safety parameter can be used with the MR-J5-_G_-RJ_, MR-J5-_G_-HS_, MR-J5W_-_G_, and MR-J5D_-_G_. For MR-J5W_-_G_, this functional safety parameter is available on servo amplifiers with firmware version D8 or later.

[Pr. PSB11_SLT torque upper limit value 2 (**SLTP2)]

Initial value	Setting range	Setting method	Ver.	
			J5G	J5G-N1
15.0 [%]	-1000.0 to 1000.0	Each axis	B2	D8

Set the upper limit threshold for the safety torque if activating the SLT function via the SLT2 command.

The STO function will activate if the torque exceeds the threshold during torque monitoring via the SLT function.

Ensure that the value set in this parameter is larger than the value set in [Pr. PSB15 SLT torque lower limit value 2]. If this functional safety parameter is set incorrectly, [AL. 537 Parameter setting range error (safety sub-function)] occurs.

This functional safety parameter can be used with the MR-J5-_G_-RJ_, MR-J5-_G_-HS_, MR-J5W_-_G_, and MR-J5D_-_G_. For MR-J5W_-_G_, this functional safety parameter is available on servo amplifiers with firmware version D8 or later.

[Pr. PSB12_SLT torque upper limit value 3 (**SLTP3)]

Initial value	Setting range	Setting method	Ver.	
			J5G	J5G-N1
15.0 [%]	-1000.0 to 1000.0	Each axis	B2	D8

Set the upper limit threshold for the safety torque if activating the SLT function via the SLT3 command.

The STO function will activate if the torque exceeds the threshold during torque monitoring via the SLT function.

Ensure that the value set in this parameter is larger than the value set in [Pr. PSB16 SLT torque lower limit value 3]. If this functional safety parameter is set incorrectly, [AL. 537 Parameter setting range error (safety sub-function)] occurs.

This functional safety parameter can be used with the MR-J5-_G_-RJ_, MR-J5-_G_-HS_, MR-J5W_-_G_, and MR-J5D_-_G_. For MR-J5W_-_G_, this functional safety parameter is available on servo amplifiers with firmware version D8 or later.

[Pr. PSB13_SLT torque upper limit value 4 (**SLTP4)]

Initial value	Setting range	Setting method	Ver.	
			J5G	J5G-N1
15.0 [%]	-1000.0 to 1000.0	Each axis	B2	D8

Set the upper limit threshold for the safety torque if activating the SLT function via the SLT4 command.

The STO function will activate if the torque exceeds the threshold during torque monitoring via the SLT function.

Ensure that the value set in this parameter is larger than the value set in [Pr. PSB17 SLT torque lower limit value 4]. If this functional safety parameter is set incorrectly, [AL. 537 Parameter setting range error (safety sub-function)] occurs.

This functional safety parameter can be used with the MR-J5-_G_-RJ_, MR-J5-_G_-HS_, MR-J5W_-_G_, and MR-J5D_-_G_. For MR-J5W_-_G_, this functional safety parameter is available on servo amplifiers with firmware version D8 or later.

[Pr. PSB14_SLT torque lower limit value 1 (**SLTN1)]

Initial value	Setting range	Setting method	Ver.	
			J5G	J5G-N1
-15.0 [%]	-1000.0 to 1000.0	Each axis	B2	D8

Set the lower limit threshold for the safety torque if activating the SLT function via the SLT1 command.

The STO function will activate if the torque falls below the threshold during torque monitoring via the SLT function.

Ensure that the value set in this parameter is smaller than the value set in [Pr. PSB10 SLT torque upper limit value 1]. If this functional safety parameter is set incorrectly, [AL. 537 Parameter setting range error (safety sub-function)] occurs.

This functional safety parameter can be used with the MR-J5-_G_-RJ_, MR-J5-_G_-HS_, MR-J5W_-_G_, and MR-J5D_-_G_. For MR-J5W_-_G_, this functional safety parameter is available on servo amplifiers with firmware version D8 or later.

[Pr. PSB15_SLT torque lower limit value 2 (**SLTN2)]

Initial value	Setting range	Setting method	Ver.	
			J5G	J5G-N1
-15.0 [%]	-1000.0 to 1000.0	Each axis	B2	D8

Set the lower limit threshold for the safety torque if activating the SLT function via the SLT2 command.

The STO function will activate if the torque falls below the threshold during torque monitoring via the SLT function.

Ensure that the value set in this parameter is smaller than the value set in [Pr. PSB11 SLT torque upper limit value 2]. If this functional safety parameter is set incorrectly, [AL. 537 Parameter setting range error (safety sub-function)] occurs.

This functional safety parameter can be used with the MR-J5-_G_-RJ_, MR-J5-_G_-HS_, MR-J5W_-_G_, and MR-J5D_-_G_. For MR-J5W_-_G_, this functional safety parameter is available on servo amplifiers with firmware version D8 or later.

[Pr. PSB16_SLT torque lower limit value 3 (**SLTN3)]

Initial value	Setting range	Setting method	Ver.	
			J5G	J5G-N1
-15.0 [%]	-1000.0 to 1000.0	Each axis	B2	D8

Set the lower limit threshold for the safety torque if activating the SLT function via the SLT3 command.

The STO function will activate if the torque falls below the threshold during torque monitoring via the SLT function.

Ensure that the value set in this parameter is smaller than the value set in [Pr. PSB12 SLT torque upper limit value 3]. If this functional safety parameter is set incorrectly, [AL. 537 Parameter setting range error (safety sub-function)] occurs.

This functional safety parameter can be used with the MR-J5-_G_-RJ_, MR-J5-_G_-HS_, MR-J5W_-_G_, and MR-J5D_-_G_. For MR-J5W_-_G_, this functional safety parameter is available on servo amplifiers with firmware version D8 or later.

[Pr. PSB17_SLT torque lower limit value 4 (**SLTN4)]

Initial value	Setting range	Setting method	Ver.	
			J5G	J5G-N1
-15.0 [%]	-1000.0 to 1000.0	Each axis	B2	D8

Set the lower limit threshold for the safety torque if activating the SLT function via the SLT4 command.

The STO function will activate if the torque falls below the threshold during torque monitoring via the SLT function.

Ensure that the value set in this parameter is smaller than the value set in [Pr. PSB13 SLT torque upper limit value 4]. If this functional safety parameter is set incorrectly, [AL. 537 Parameter setting range error (safety sub-function)] occurs.

This functional safety parameter can be used with the MR-J5-_G_-RJ_, MR-J5-_G_-HS_, MR-J5W_-_G_, and MR-J5D_-_G_. For MR-J5W_-_G_, this functional safety parameter is available on servo amplifiers with firmware version D8 or later.

[Pr. PSB18_SLT torque detection delay time (**SLTT)]

Initial value	Setting range	Setting method	Ver.	
			J5G	J5G-N1
10 [ms]	0 to 2000	Each axis	B2	D8

Specify the filter time of the delay filter that will judge whether the motor position has exceeded the threshold during torque monitoring. The setting of this functional safety parameter delays the response time of torque monitoring.

This functional safety parameter can be used with the MR-J5-_G_-RJ_, MR-J5-_G_-HS_, MR-J5W_-_G_, and MR-J5D_-_G_. For MR-J5W_-_G_, this functional safety parameter is available on servo amplifiers with firmware version D8 or later.

7.3 Network parameters group ([Pr. PSC_ _])

[Pr. PSC01_Transmission interval monitor time (**SNC)]

Initial value	Setting range	Setting method	Ver.
32 [ms]	16 to 1000	Common	B2

Select the transmission interval monitor time for safety communication.

Set the transmission interval monitor time so that it matches the safety communication setting of the controller.

This functional safety parameter can be used with the MR-J5-_G_-RJ_, MR-J5-_G_-HS_, MR-J5W_-_G_, and MR-J5D_-_G_. For MR-J5W_-_G_, this functional safety parameter is available on servo amplifiers with firmware version D8 or later.

This functional safety parameter can be used only with CC-Link IE TSN.

[Pr. PSC03_Functional safety - Rotation direction selection/travel direction selection (**SNPOL)]

Initial value	Setting range	Setting method	Ver.
00000010h	Refer to the relevant detail No.	Each axis	Refer to the relevant detail No.

The rotation/travel direction can be changed without changing the polarity of the command from the controller.

[Pr. PSC03.0_Rotation direction selection/travel direction selection]

Initial value	Setting range	Ver.	
		J5G	J5G-N1
0h	Refer to the text	B2	D8

Set this functional safety parameter to the same value as [Pr. PA14 Travel direction selection].

Refer to the following table for setting values.

Setting value	Servo motor rotation direction/linear servo motor travel direction	
	At forward rotation pulse input	At reverse rotation pulse input
0	CCW or positive direction	CW or negative direction
1	CW or negative direction	CCW or positive direction

If this functional safety parameter is set incorrectly, [AL. 537 Parameter setting range error (safety sub-function)] occurs.

This functional safety parameter can be used with the MR-J5-_G_-RJ_, MR-J5-_G_-HS_, MR-J5W_-_G_, and MR-J5D_-_G_. For MR-J5W_-_G_, this functional safety parameter is available on servo amplifiers with firmware version D8 or later.

[Pr. PSC05_Safety communication - Function setting (**SCFS)]

Initial value	Setting range	Setting method	Ver.
0000000h	00000000h to 00000131h	Common	Refer to the relevant detail No.

[Pr. PSC05.2_SNERR2 signal selection]

Initial value	Setting range	Ver.
0h	Refer to the text	D8

Set the SNERR2 signal to be transmitted via a network.

0:Each axis

1:Last axis

When "0" is set, the SNERR2 signal sent from the servo amplifier indicates information of each axis.

When "1" is set, the SNERR2 signal sent from the servo amplifier indicates information of the last axis.

If the firmware version of the servo amplifier is earlier than D8, information of the last axis is sent regardless of the setting value of this servo parameter.

Set "1" (last axis) when using a servo amplifier with firmware version earlier than D8 for activation.

[Pr. PSC06_Safety verification code (**SAC)]

When the command interface of the servo amplifier is EtherCAT, this servo parameter is not available.

Initial value	Setting range	Setting method	Ver.
FFFFFFFFh	00000000h to FFFFFFFFh	Common	B2

Set the safety verification code for safety communication.

Doing so sets the value used to identify the servo amplifier. Set the MAC address, etc. so that it is not identical to that of a different servo amplifier.

Match the safety verification code to the value set in the safety communication setting of the master station. If this parameter is set to a non-matching value, [AL. 580 Safety communication setting error (safety sub-function)] occurs.

When setting the MAC address, set the lower 8 digits.

This functional safety parameter can be used with the MR-J5-_G_-RJ, MR-J5-_G_-HS, MR-J5W_-_G_, and MR-J5D_-_G_.

For MR-J5W_-_G_, this functional safety parameter is available on servo amplifiers with firmware version D8 or later.

This functional safety parameter can be used only with CC-Link IE TSN.

[Pr. PSC07_FSoE Address setting (**FSADD)]

When the command interface of the servo amplifier is CC-Link IE TSN, this functional safety parameter is not available.

Initial value	Setting range	Setting method	Ver.
0	0 to 65535	Common	D8

Set the FSoE Slave address of the servo amplifier within the range of 1 to 65535.

Set the value used to identify FSoE Slave. Ensure that FSoE Slave has a unique value.

Match the value of FSoE Master with this functional safety parameter. If it is set to a non-matching value, [AL. 584 FSoE communication setting error (safety sub-function)] occurs.

When [Pr. PSA01.0 Safety sub-function activation setting] is set to "1" (enabled) and [Pr. PSA01.1 Input mode selection] is set to "1" (safety sub-function control by network), setting this functional safety parameter to "0" triggers [AL. 537 Parameter setting range error (Safety sub-function)].

[Pr. PSC08_Safety communication - Functional safety disabled setting (**SCFN)]

Initial value	Setting range	Setting method	Ver.
0h	Refer to the relevant detail No.	Common	Refer to the relevant detail No.

The setting value of this servo parameter is enabled only when the safety sub-function by network is used.

The disabled safety function will be deactivated even if the clear command is not notified through safety communication.

[Pr. PSC08.0_Functional safety disabled setting 1]

Initial value	Setting range	Ver.
0h	Refer to the text	D8

Setting digit (BIN)	Explanation
___x	For manufacturer setting
__x_	For manufacturer setting
_x__	SS1C (SS1 command) 0:Enabled 1:Disabled
x___	SS2C (SS2 command) 0:Enabled 1:Disabled

[Pr. PSC08.1_Functional safety disabled setting 2]

Initial value	Setting range	Ver.
0h	Refer to the text	D8

Setting digit (BIN)	Explanation
___x	SLS1C (SLS1 command) 0:Enabled 1:Disabled
__x_	SLS2C (SLS2 command) 0:Enabled 1:Disabled
_x__	SLS3C (SLS3 command) 0:Enabled 1:Disabled
x___	SLS4C (SLS4 command) 0:Enabled 1:Disabled

[Pr. PSC08.2_Functional safety disabled setting 3]

Initial value	Setting range	Ver.
0h	Refer to the text	D8
Setting digit (BIN)	Explanation	
___x	SDIPC (SDIP command) 0:Enabled 1:Disabled	
__x_	SDINC (SDIN command) 0:Enabled 1:Disabled	
_x__	SLT1C (SLT1 command) 0:Enabled 1:Disabled	
x___	SLT2C (SLT2 command) 0:Enabled 1:Disabled	

[Pr. PSC08.3_Functional safety disabled setting 4]

Initial value	Setting range	Ver.
0h	Refer to the text	D8
Setting digit (BIN)	Explanation	
___x	SLT3C (SLT3 command) 0:Enabled 1:Disabled	
__x_	SLT4C (SLT4 command) 0:Enabled 1:Disabled	
_x__	SLIC (SLI command) 0:Enabled 1:Disabled	
x___	For manufacturer setting	

[Pr. PSC09_Safety communication - Output signal polarity setting (**SFPOL)]

Initial value	Setting range	Setting method	Ver.
0h	Refer to the relevant detail No.	Common	B2

The setting value of this servo parameter is enabled only when the safety sub-function by network is used.

The polarity of the feedback status information for the safety communication can be reversed.

For details of the status information, refer to "Safety sub-function control by network" in the MR-J5 User's Manual (Function).

[Pr. PSC09.0_Output signal polarity setting 1]

Initial value	Setting range	Ver.
0h	Refer to the text	D8

Setting digit (BIN)	Explanation
___x	For manufacturer setting
__x_	STOS (STO output) 0:Disabled 1:Enabled (Reverse polarity)
_x__	SS1S (SS1 output) 0:Disabled 1:Enabled (Reverse polarity)
x___	SS2S (SS2 output) 0:Disabled 1:Enabled (Reverse polarity)

[Pr. PSC09.1_Output signal polarity setting 2]

Initial value	Setting range	Ver.
0h	Refer to the text	D8

Setting digit (BIN)	Explanation
___x	SLS1S (SLS1 output) 0:Disabled 1:Enabled (Reverse polarity)
__x_	SLS2S (SLS2 output) 0:Disabled 1:Enabled (Reverse polarity)
_x__	SLS3S (SLS3 output) 0:Disabled 1:Enabled (Reverse polarity)
x___	SLS4S (SLS4 output) 0:Disabled 1:Enabled (Reverse polarity)

[Pr. PSC09.2_Output signal polarity setting 3]

Initial value	Setting range	Ver.
0h	Refer to the text	D8
Setting digit (BIN)	Explanation	
___x	SSM (SSM output) 0:Disabled 1:Enabled (Reverse polarity)	
__x_	SOS (SOS output) 0:Disabled 1:Enabled (Reverse polarity)	
_x__	SBC (SBC output) 0:Disabled 1:Enabled (Reverse polarity)	
x___	SDIPS (SDIP output) 0:Disabled 1:Enabled (Reverse polarity)	

[Pr. PSC09.3_Output signal polarity setting 4]

Initial value	Setting range	Ver.
0h	Refer to the text	D8
Setting digit (BIN)	Explanation	
___x	SDINS (SDIN output) 0:Disabled 1:Enabled (Reverse polarity)	
__x_	SLT1S (SLT1 output) 0:Disabled 1:Enabled (Reverse polarity)	
_x__	SLT2S (SLT2 output) 0:Disabled 1:Enabled (Reverse polarity)	
x___	SLT3S (SLT3 output) 0:Disabled 1:Enabled (Reverse polarity)	

[Pr. PSC09.4_Output signal polarity setting 5]

Initial value	Setting range	Ver.
0h	Refer to the text	D8
Setting digit (BIN)	Explanation	
___x	SLT4S (SLT4 output) 0:Disabled 1:Enabled (Reverse polarity)	
__x_	For manufacturer setting	
_x__	SLIS (SLI output) 0:Disabled 1:Enabled (Reverse polarity)	
x___	For manufacturer setting	

7.4 Safety I/O device parameters group ([Pr. PSD_ _])

[Pr. PSD01_Input device automatic activation selection (**SDIA)]

Initial value	Setting range	Setting method	Ver.
00000000h	Refer to the relevant detail No.	Each axis	Refer to the relevant detail No.

This setting is enabled only when using an input device. This setting allows for automatic activation of the SLS function, SLT function, and SDI function. The command set for automatic activation in this setting turns off (function enabled) at system startup, following which the relevant function will start automatically.

Speed monitoring via the SLS function is always enabled when automatically activating SLS1C to SLS4C.

If this functional safety parameter is set incorrectly, [AL. 537 Parameter setting range error (safety sub-function)] occurs.

[Pr. PSD01.0_SLSC function automatic activation selection]

Initial value	Setting range	Ver.	
		J5G	J5G-N1
0h	Refer to the text	B2	D8

Setting digit (BIN)	Explanation
___x	SLS1C (SLS1 command) 0: Do not perform automatic activation 1: Perform automatic activation
__x_	SLS2C (SLS2 command) 0: Do not perform automatic activation 1: Perform automatic activation
_x__	SLS3C (SLS3 command) 0: Do not perform automatic activation 1: Perform automatic activation
x___	SLS4C (SLS4 command) 0: Do not perform automatic activation 1: Perform automatic activation

[Pr. PSD01.1_SLTC function automatic activation selection]

Initial value	Setting range	Ver.	
		J5G	J5G-N1
0h	Refer to the text	B2	D8

Setting digit (BIN)	Explanation
___x	SLT1C (SLT1 command) 0: Do not perform automatic activation 1: Perform automatic activation
__x_	SLT2C (SLT2 command) 0: Do not perform automatic activation 1: Perform automatic activation
_x__	SLT3C (SLT3 command) 0: Do not perform automatic activation 1: Perform automatic activation
x___	SLT4C (SLT4 command) 0: Do not perform automatic activation 1: Perform automatic activation

[Pr. PSD01.2_SDIC function automatic activation selection]

Initial value	Setting range	Ver.	
		J5G	J5G-N1
0h	Refer to the text	B2	D8

Setting digit (BIN)	Explanation
___x	SDIPC (SDIP command) 0: Do not perform automatic activation 1: Perform automatic activation
__x_	SDINC (SDIN command) 0: Do not perform automatic activation 1: Perform automatic activation
_x__	For manufacturer setting
x___	For manufacturer setting

[Pr. PSD02_Safety input device selection DI1 (**SDI1)]

Initial value	Setting range	Setting method	Ver.
00000000h	Refer to the relevant detail No.	Common	Refer to the relevant detail No.

Select the input device to be assigned to SDI1A and SDI1B.

Assign a device to [Pr. PSD02 Safety Input device selection DI1] if "0" (safety sub-function control by input device) is selected in [Pr. PSA01.1 Input mode selection]. If no device is set to [Pr. PSD02], [AL. 537 Parameter setting range error (safety sub-function)] occurs.

If this functional safety parameter is set incorrectly, [AL. 537] occurs.

Refer to the following table for the connector pin corresponding to each SDI.

Hardware symbol	Corresponding connector pin	
	MR-J5-_G_-RJ_, MR-J5W-_G_, MR-J5D_-_G_	MR-J5-_G_-HS_
SDI1A	CN8-4	CN3-8A
SDI1B	CN8-5	CN3-8B

[Pr. PSD02.0-1_Safety input device selection DI1]

Initial value	Setting range	Ver.
00h	Refer to the text	B2

Select the function to be assigned to SDI1A and SDI1B.

Refer to the following table for setting values.

Setting value	Input device
00	None
01	STOC (STO command)
02	SS1C (SS1 command)
03	SS2C (SS2 command)
04	SLS1C (SLS1 command)
05	SLS2C (SLS2 command)
06	SLS3C (SLS3 command)
07	SLS4C (SLS4 command)
08	SDIPC (SDIP command)
09	SDINC (SDIN command)
0A	SLT1C (SLT1 command)
0B	SLT2C (SLT2 command)
0C	SLT3C (SLT3 command)
0D	SLT4C (SLT4 command)
0E	SLIC (SLI command)

If an unavailable input device for the safety sub-function is selected, [AL. 537] occurs. For availability of each safety sub-function, refer to "List of safety sub-function compatible units" in the User's Manual (Introduction).

[Pr. PSD02.3_Input axis selection DI1]

Initial value	Setting range	Ver.
0h	Refer to the text	B2

For a multi-axis servo amplifier, set which axis will use the input device that was assigned in [Pr. PSD02.0-1 Safety input device selection DI1].

When this functional safety parameter is set to "0h", the input device is enabled for all axes using the automatic setting.

If this functional safety parameter is not "0h", refer to the following table.

Servo parameter number	Setting digit (BIN)	Setting details
PSD02.3	__ _ x	A-axis selection 0: Disabled 1: Enabled
	_ _ x _	B-axis selection 0: Disabled 1: Enabled
	_ x _ _	C-axis selection 0: Disabled 1: Enabled
	x _ _ _	For manufacturer setting

When A-axis selection is enabled, the device name is __ _-A. (example: "STOC-A")

When B-axis selection is enabled, the device name is __ _-B. (example: "STOC-B")

When C-axis selection is enabled, the device name is __ _-C. (example: "STOC-C")

When multiple axes are enabled with this functional safety parameter, the input device signal is enabled for multiple axes simultaneously.

For example, when [Pr. PSD02.3] = "5h" (A and C-axes enabled) and [Pr. PSD02.0] = "01h" (STOC) are set for the A-axis, STOC-A and STOC-C are enabled with the input signal of the SDI1 pin.

In the following cases, [AL. 537 Parameter setting range error (safety sub-function)] occurs.

- When a value other than "0h" is set on the MR-J5-_G_-RJ, MR-J5-_G_-HS, and MR-J5D1-_G_
- When C-axis selection is enabled on the MR-J5W2-G and MR-J5D2-G

[Pr. PSD03_Safety input device selection DI2 (**SDI2)]

Initial value	Setting range	Setting method	Ver.
00000000h	Refer to the relevant detail No.	Common	Refer to the relevant detail No.

Select the input device to be assigned to SDI2A and SDI2B.

Refer to the following table for the connector pin corresponding to each SDI.

Hardware symbol	Corresponding connector pin	
	MR-J5-_G_-RJ_, MR-J5W_-G_, MR-J5D_- _G_	MR-J5-_G_-HS_
SDI2A	—	CN3-12A
SDI2B	—	CN3-12B

[Pr. PSD03.0-1_Safety input device selection DI2]

Initial value	Setting range	Ver.
00h	00h to 0Eh	E0

Select the function to be assigned to SDI2A and SDI2B.

Refer to the following for details of the setting values.

☞ Page 280 [Pr. PSD02_Safety input device selection DI1 (**SDI1)]

This functional safety parameter can be used only with the MR-J5-_G_-HS_. Setting a value other than "00h" on the other servo amplifiers triggers [AL. 537 Parameter setting range error (safety sub-function)].

[Pr. PSD04_Safety input device selection DI3 (**SDI3)]

Initial value	Setting range	Setting method	Ver.
00000000h	Refer to the relevant detail No.	Common	Refer to the relevant detail No.

Select the input device to be assigned to SDI3A and SDI3B.

Refer to the following table for the connector pin corresponding to each SDI.

Hardware symbol	Corresponding connector pin	
	MR-J5-_G_-RJ_, MR-J5W_-G_, MR-J5D_- _G_	MR-J5-_G_-HS_
SDI3A	—	CN3-13A
SDI3B	—	CN3-13B

[Pr. PSD04.0-1_Safety input device selection DI3]

Initial value	Setting range	Ver.
00h	00h to 0Eh	E0

Select the function to be assigned to SDI3A and SDI3B.

Refer to the following for details of the setting values.

☞ Page 280 [Pr. PSD02_Safety input device selection DI1 (**SDI1)]

This functional safety parameter can be used only with the MR-J5-_G_-HS_. Setting a value other than "00h" on the other servo amplifiers triggers [AL. 537 Parameter setting range error (safety sub-function)].

[Pr. PSD08_Safety output device selection DO1 (**SDO1)]

Initial value	Setting range	Setting method	Ver.
00000000h	Refer to the relevant detail No.	Common	Refer to the relevant detail No.

Select the output device to be assigned to SDO1A and SDO1B.

If this functional safety parameter is set incorrectly, [AL. 537 Parameter setting range error (safety sub-function)] occurs.

Refer to the following table for the connector pin corresponding to each SDI.

Hardware symbol	Corresponding connector pin	
	MR-J5-_G_-RJ_, MR-J5W_-G_, MR-J5D_- _G_	MR-J5-_G_-HS_
SDO1A	CN8-6	CN3-11A
SDO1B	CN8-7	CN3-11B

[Pr. PSD08.0-1_Safety output device selection DO1]

Initial value	Setting range	Ver.
00h	Refer to the text	B2

Select the function to be assigned to SDO1A and SDO1B.

Refer to the following table for setting values.

Setting value	Output device
00	None
01	STOS (STO output)
02	SS1S (SS1 output)
03	SS2S (SS2 output)
04	SLS1S (SLS1 output)
05	SLS2S (SLS2 output)
06	SLS3S (SLS3 output)
07	SLS4S (SLS4 output)
08	SSMS (SSM output)
09	SOSS (SOS output)
0A	SBCS (SBC output)
0B	SDIPS (SDIP output)
0C	SDINS (SDIN output)
0D	SLT1S (SLT1 output)
0E	SLT2S (SLT2 output)
0F	SLT3S (SLT3 output)
10	SLT4S (SLT4 output)
12	SLIS (SLI output)

If an unavailable output device of the safety sub-function is selected, [AL. 537] occurs. For availability of each safety sub-function, refer to "List of safety sub-function compatible units" in the User's Manual (Introduction).

[Pr. PSD08.2_All-axis output condition selection DO1]

Initial value	Setting range	Ver.
0h	Refer to the text	B2

0: AND output

1: OR output

For AND output, the condition becomes significant (on or off) when the A, B, and C-axes all satisfy the condition.

The device name at this time is C-___. (example: "C-STOS")

For OR output, the condition becomes significant (on or off) when any of A, B, or C-axis satisfies the condition.

The device name at this time is X-___. (example: "X-STOS")

This functional safety parameter is enabled when [Pr. PSD08.3 Output axis selection] is set to "0" (all axes) while a multi-axis amplifier is used.

[Pr. PSD08.3_Output axis selection DO1]

Initial value	Setting range	Ver.
0h	Refer to the text	B2

0: All axes

1: A-axis

2: B-axis

3: C-axis

If the setting value is 1, the device name is ___-A. (example: "STOS-A")

If the setting value is 2, the device name is ___-B. (example: "STOS-B")

If the setting value is 3, the device name is ___-C. (example: "STOS-C")

[Pr. PSD09_Safety output device selection DO2 (**SDO2)]

Initial value	Setting range	Setting method	Ver.
00000000h	Refer to the relevant detail No.	Common	Refer to the relevant detail No.

Select the output device to be assigned to SDO2A/SDO2B.

Refer to the following table for the connector pin corresponding to each SDO.

Hardware symbol	Corresponding connector pin	
	MR-J5-_G_-RJ_, MR-J5W-_G_, MR-J5D_-_G_	MR-J5-_G_-HS_
SDO2A	—	CN3-14A
SDO2B	—	CN3-14B

[Pr. PSD09.0-1_Safety output device selection DO2]

Initial value	Setting range	Ver.
00h	00h to 1Fh	E0

Select the function to be assigned to SDO2A and SDO2B.

Refer to the following for details of the setting values.

☞ Page 283 [Pr. PSD08_Safety output device selection DO1 (**SDO1)]

This functional safety parameter can be used only with the MR-J5-_G_-HS_. Setting a value other than "00h" on the other servo amplifiers triggers [AL. 537 Parameter setting range error (safety sub-function)].

[Pr. PSD10_Safety output device selection DO3 (**SDO3)]

Initial value	Setting range	Setting method	Ver.
00000000h	Refer to the relevant detail No.	Common	Refer to the relevant detail No.

Select the output device to be assigned to SDO3PA, SDO3NA, SDO3PB, and SDO3NB.

Refer to the following table for the connector pin corresponding to each SDO.

Hardware symbol	Corresponding connector pin	
	MR-J5-_G_-RJ_, MR-J5W_-G_, MR-J5D_- _G_	MR-J5-_G_-HS_
SDO3PA	—	CN3-15A
SDO3NA	—	CN3-16A
SDO3PB	—	CN3-15B
SDO3NB	—	CN3-16B

[Pr. PSD10.0-1_Safety output device selection DO3]

Initial value	Setting range	Ver.
00h	00h to 1Fh	E0

Select the function to be assigned to SDO3PA, SDO3NA, SDO3PB, and SDO3NB.

Refer to the following for details of the setting values.

 Page 283 [Pr. PSD08_Safety output device selection DO1 (**SDO1)]

When this parameter is set "00h" on MR-J5-_G_-HS, it operates as PLSPA, PLSNA, PLSPB, and PLSNB.

This functional safety parameter can be used only with the MR-J5-_G_-HS_. Setting a value other than "00h" on the other servo amplifiers triggers [AL. 537 Parameter setting range error (safety sub-function)].

[Pr. PSD12_Input device - Noise elimination filter time DI1 (**SDIF1)]

Initial value	Setting range	Setting method	Ver.
00000001h	Refer to the relevant detail No.	Common	Refer to the relevant detail No.

Select the noise elimination filter time for SDI1A and SDI1B.

Refer to the following table for details.

Configuration		Noise elimination filter time
Using a switch	Test pulse diagnosis is performed.	Set a time that is at least 1.00 ms longer than the time set in [Pr. PSD26.0_Input device - Test pulse off time].
	Test pulse diagnosis is not performed.	Set 1.00 ms or more.
Using a machine utilizing the diagnosis function	Test pulses are in superposition in the output signal of the device.	Set a time that is at least 1.00 ms longer than the off time for test pulses output by the machine.
	Test pulses are not in superposition in the output signal of the device.	Set 1.00 ms or more.

When the functional safety parameter is set incorrectly, [[AL. 537 Parameter setting range error (safety sub-function)] will occur.

[Pr. PSD12.0-1_Noise elimination filter time DI1]

Initial value	Setting range	Ver.
01h	Refer to the text	B2

Select the filter time for SDI1A and SDI1B.

Refer to the following table for setting values.

Setting value	Filtering time [ms]
00	1.000
01	2.000
02	4.000
03	8.000
04	16.000
05	32.000

[Pr. PSD13_Input device - Noise elimination filter time DI2 (**SDIF2)]

Initial value	Setting range	Setting method	Ver.
00000001h	Refer to the relevant detail No.	Common	Refer to the relevant detail No.

Select the noise elimination filter time for SDI2A and SDI2B.

☞ Page 286 [Pr. PSD12_Input device - Noise elimination filter time DI1 (**SDIF1)]

When the functional safety parameter is set incorrectly, [[AL. 537 Parameter setting range error (safety sub-function)] will occur.

[Pr. PSD13.0-1_Noise elimination filter time DI2]

Initial value	Setting range	Ver.
01h	00h to 05h	E0

Select the noise elimination filter time for SDI2A and SDI2B.

Refer to the following for details of the setting values.

☞ Page 286 [Pr. PSD12_Input device - Noise elimination filter time DI1 (**SDIF1)]

This functional safety parameter can be used only with the MR-J5-_G_-HS_.

[Pr. PSD14_Input device - Noise elimination filter time DI3 (**SDIF3)]

Initial value	Setting range	Setting method	Ver.
00000001h	Refer to the relevant detail No.	Common	Refer to the relevant detail No.

Select the noise elimination filter time for SDI3A and SDI3B.

☞ Page 286 [Pr. PSD12_Input device - Noise elimination filter time DI1 (**SDIF1)]

When the functional safety parameter is set incorrectly, [[AL. 537 Parameter setting range error (safety sub-function)] will occur.

[Pr. PSD14.0-1_Noise elimination filter time DI3]

Initial value	Setting range	Ver.
01h	00h to 05h	E0

Select the noise elimination filter time for SDI3A and SDI3B.

Refer to the following for details of the setting values.

☞ Page 286 [Pr. PSD12_Input device - Noise elimination filter time DI1 (**SDIF1)]

This functional safety parameter can be used only with the MR-J5-_G_-HS_.

[Pr. PSD18_Permissible time for mismatches DI1 (**SDIDT1)]

Initial value	Setting range	Setting method	Ver.
20 [ms]	0 to 60000	Common	B2

Set the permissible mismatched time for SDI1A and SDI1B.

When SDI1A and SDI1B remained mismatched for longer than the specified time, [AL. 557 Input device mismatch detection (safety sub-function)] will occur.

If it is set to "0", the alarm will not be detected.

If [Pr. PSA01.0 Safety sub-function activation setting] is set to "0" (disabled), the alarm occurs in 10000 ms (10 s).

Refer to the following table for details.

Model	Setting of [Pr. PSA01.0]	Parameter to be used	Time required for alarm to occur	Alarm to occur
MR-J5-_G_-RJ_	0: Disabled	—	Fixed to 10 s	[AL. 557]
MR-J5-_G_-HS_ MR-J5W-_G_ MR-J5D_-_G_	1: Enabled	[Pr. PSD18]	0 to 60000 ms	[AL. 557]

[Pr. PSD19_Permissible time for mismatches DI2 (**SDIDT2)]

Initial value	Setting range	Setting method	Ver.
20 [ms]	0 to 60000	Common	E0

Set the permissible mismatched time for SDI2A and SDI2B.

When SDI2A and SDI2B remained mismatched for longer than the specified time, [AL. 557 Input device mismatch detection (safety sub-function)] will occur.

If it is set to "0", the alarm will not be detected.

[Pr. PSD20_Permissible time for mismatches DI3 (**SDIDT3)]

Initial value	Setting range	Setting method	Ver.
20 [ms]	0 to 60000	Common	E0

Set the permissible mismatched time for SDI3A and SDI3B.

When SDI3A and SDI3B remained mismatched for longer than the specified time, [AL. 557 Input device mismatch detection (safety sub-function)] will occur.

If it is set to "0", the alarm will not be detected.

[Pr. PSD24_Input device - Test pulse diagnosis execution selection 1 (**SDIP1)]

Initial value	Setting range	Setting method	Ver.
00001111h	Refer to the relevant detail No.	Common	Refer to the relevant detail No.

Select whether to perform a diagnosis using test pulses for SDI1A to SDI1B and SDI3A to SDI3B.

This functional safety parameter can be used only with the MR-J5-_G_-HS_.

[Pr. PSD24.0_Test pulse diagnosis execution selection D11]

Initial value	Setting range	Ver.
1h	Refer to the text	E0

Select whether to perform a diagnosis using test pulses for SDI1A and SDI1B.

When performing a test pulse diagnosis from external devices or by other means, select "0" (Do not perform diagnosis).

0: Do not perform diagnosis

1: Perform diagnosis

[Pr. PSD24.1_Test pulse diagnosis execution selection D12]

Initial value	Setting range	Ver.
1h	Refer to the text	E0

Select whether to perform a diagnosis using test pulses for SDI2A and SDI2B.

When performing a test pulse diagnosis from external devices or by other means, select "0" (Do not perform diagnosis).

0: Do not perform diagnosis

1: Perform diagnosis

[Pr. PSD24.2_Test pulse diagnosis execution selection D13]

Initial value	Setting range	Ver.
1h	Refer to the text	E0

Select whether to perform a diagnosis using test pulses for SDI3A and SDI3B.

When performing a test pulse diagnosis from external devices or by other means, select "0" (Do not perform diagnosis).

0: Do not perform diagnosis

1: Perform diagnosis

[Pr. PSD26_Input device - Test pulse off time 1 (** SDIPW)]

Initial value	Setting range	Setting method	Ver.
00000001h	Refer to the relevant detail No.	Common	Refer to the relevant detail No.

Select the off time for test pulses output from PLSNA and PLSNB.

This functional safety parameter can be used only with the MR-J5-_G_-HS_.

[Pr. PSD26.0_Input device - Test pulse off time]

Initial value	Setting range	Ver.
0h	Refer to the text	E0

Select the off time for test pulses output from PLSNA and PLSNB.

When performing a test pulse diagnosis with PLSNA and PLSNB connected to the input device of the MR-J5 servo amplifier, set this functional safety parameter to "1" (1.000 ms).

Refer to the following table for setting values.

Setting value	Off time [ms]
1	1.000
2	2.000

[Pr. PSD27_Input device - Fixing diagnosis at startup execution selection 1 (**SDID1)]

Initial value	Setting range	Setting method	Ver.
00001111h	Refer to the relevant detail No.	Common	Refer to the relevant detail No.

Select whether to perform a fixing diagnosis at startup for SDI1A to SDI1B and SDI3A to SDI3B.

This functional safety parameter can be used only with the MR-J5-_G_-HS_.

[Pr. PSD27.0_Fixing diagnosis at startup execution selection DI1]

Initial value	Setting range	Ver.
1h	Refer to the text	E0

Select whether to perform a fixing diagnosis at startup for SDI3A and SDI3B.

0: Do not perform diagnosis

1: Perform diagnosis

[Pr. PSD27.1_Fixing diagnosis at startup execution selection DI2]

Initial value	Setting range	Ver.
1h	Refer to the text	E0

Select whether to perform a fixing diagnosis at startup for SDI2A and SDI2B.

0: Do not perform diagnosis

1: Perform diagnosis

[Pr. PSD27.2_Fixing diagnosis at startup execution selection DI3]

Initial value	Setting range	Ver.
1h	Refer to the text	E0

Select whether to perform a fixing diagnosis at startup for SDI3A and SDI3B.

0: Do not perform diagnosis

1: Perform diagnosis

[Pr. PSD29_Output device - Test pulse diagnosis execution selection (**SDOP)]

Initial value	Setting range	Setting method	Ver.
00001111h	Refer to the relevant detail No.	Common	Refer to the relevant detail No.

Select whether to perform a diagnosis using test pulses for SDO1A to SDO1B and SDO3A to SDO3B.

[Pr. PSD29.0_Test pulse diagnosis execution selection DO1]

Initial value	Setting range	Ver.
1h	Refer to the text	B2

Select whether to perform a diagnosis using test pulses for SDO1A and SDO1B.

When "0" (Do not perform diagnosis) is selected, no test pulses are output from SDO1A/SDO1B.

0: Do not perform diagnosis

1: Perform diagnosis

[Pr. PSD29.1_Test pulse diagnosis execution selection DO2]

Initial value	Setting range	Ver.
1h	Refer to the text	B2

Select whether to perform a diagnosis using test pulses for SDO2A and SDO2B.

When "0" (Do not perform diagnosis) is selected, no test pulses are output from SDO2A/SDO2B.

0: Do not perform diagnosis

1: Perform diagnosis

[Pr. PSD29.2_Test pulse diagnosis execution selection DO3]

Initial value	Setting range	Ver.
1h	Refer to the text	B2

Select whether to perform a diagnosis using test pulses for SDO3NA and SDO3NB.

When "0" (Do not perform diagnosis) is selected, no test pulses are output from SDO3NA and SDO3NB.

0: Do not perform diagnosis

1: Perform diagnosis

[Pr. PSD30_Output device - Test pulse off time (**SDOPW)]

Initial value	Setting range	Setting method	Ver.
00000000h	Refer to the relevant detail No.	Common	Refer to the relevant detail No.

Select the off time for test pulses output from SDO1A to SDO1B and SDO3A to SDO3B.

[Pr. PSD30.0_Test pulse off time DO1]

Initial value	Setting range	Ver.
0h	Refer to the text	B2

Select the off time for test pulses output from SDO1A and SDO1B.

The setting value of this servo parameter is enabled only when [Pr. PSD29.0 Test pulse diagnosis execution selection DO1] is set to "1".

Refer to the following table for setting values.

Setting value	Off time [ms]
0	0.500
1	1.000
2	2.000

[Pr. PSD30.1_Test pulse off time DO2]

Initial value	Setting range	Ver.
0h	0h to 2h	E0

Select the off time for test pulses output from SDO2A and SDO2B.

The setting value of this servo parameter is enabled only when [Pr. PSD29.1 Test pulse diagnosis execution selection DO2] is set to "1".

Refer to the following for details of the setting values.

☞ Page 292 [Pr. PSD30_Output device - Test pulse off time (**SDOPW)]

[Pr. PSD30.2_Test pulse off time DO3]

Initial value	Setting range	Ver.
0h	0h to 2h	E0

Select the off time for test pulses output from SDO3NA and SDO3NB.

The setting value of this servo parameter is enabled only when [Pr. PSD29.2 Test pulse diagnosis execution selection DO3] is set to "1".

Refer to the following for details of the setting values.

☞ Page 292 [Pr. PSD30_Output device - Test pulse off time (**SDOPW)]

[Pr. PSD31_Output device - Feedback diagnosis execution selection (**SDOD1)]

Initial value	Setting range	Setting method	Ver.
00001111h	Refer to the relevant detail No.	Common	Refer to the relevant detail No.

Select whether to perform a feedback diagnosis for the output signal of SDO1A to SDO1B and SDO3A to SDO3B.

[Pr. PSD31.0_Feedback diagnosis execution selection DO1]

Initial value	Setting range	Ver.
1h	Refer to the text	B2

Select whether to perform a feedback diagnosis for SDO1A and SDO1B.

Normally, do not change the setting from "1" (Perform diagnosis).

0: Do not perform diagnosis

1: Perform diagnosis

[Pr. PSD31.1_Feedback diagnosis execution selection DO2]

Initial value	Setting range	Ver.
1h	Refer to the text	E0

Select whether to perform a feedback diagnosis for SDO2A and SDO2B.

Normally, do not change the setting from "1" (Perform diagnosis).

0: Do not perform diagnosis

1: Perform diagnosis

[Pr. PSD31.2_Feedback diagnosis execution selection DO3]

Initial value	Setting range	Ver.
1h	Refer to the text	E0

Select whether to perform a feedback diagnosis for SDO3NA and SDO3NB.

Normally, do not change the setting from "1" (Perform diagnosis).

0: Do not perform diagnosis

1: Perform diagnosis

7.5 Extension setting 3 parameters group ([Pr. PSL_ _])

[Pr. PSL02_Functional safety - Linear encoder resolution setting - Numerator (**SLIM)]

Initial value	Setting range	Setting method	Ver.
1000 [μm]	1 to 65535	Each axis	B2

Set the linear encoder resolution with [Pr. PSL02] and [Pr. PSL03 Functional safety - Linear encoder resolution setting - Denominator].

Set a numerator in [Pr. PSL02].

This functional safety parameter is only enabled when using a linear servo motor.

Be sure to set this parameter to the same value set in [Pr. PL02 Linear encoder resolution setting - Numerator] when executing position monitoring or speed monitoring for a linear servo motor. If this parameter is set to a non-matching value, [AL. 537 Parameter setting range error (safety sub-function)] occurs.

[Pr. PSL03_Functional safety - Linear encoder resolution setting - Denominator (**SLID)]

Initial value	Setting range	Setting method	Ver.
1000 [μm]	1 to 65535	Each axis	B2

Set the linear encoder resolution with [Pr. PSL02 Functional safety - Linear encoder resolution setting - Numerator] and [Pr. PSL03].

Set a denominator in [Pr. PSL03].

This functional safety parameter is only enabled when using a linear servo motor.

Be sure to set this parameter to the same value set in [Pr. PL03 Linear encoder resolution setting - Denominator] when executing position monitoring or speed monitoring for a linear servo motor. If this parameter is set to a non-matching value, [AL. 537 Parameter setting range error (safety sub-function)] occurs.

8 LISTS OF FUNCTIONAL SAFETY PARAMETER INITIAL VALUES

8.1 Safety sub-function 1 parameters group ([Pr. PSA_ _])

No.	Setting method	Initial value
PSA01	Common	00000000h
PSA02	Each axis	00000000h
PSA03	Each axis	1000
PSA04	Each axis	50
PSA05	Each axis	3
PSA06	Each axis	00000000h
PSA07	Each axis	1000
PSA08	Each axis	1000
PSA09	Each axis	1000
PSA10	Each axis	1000
PSA11	Each axis	50
PSA12	Each axis	50
PSA13	Each axis	50
PSA14	Each axis	50
PSA15	Each axis	10
PSA16	—	00000000h
PSA17	Each axis	0
PSA18	Each axis	50
PSA19	Each axis	20
PSA20	Each axis	67108864
PSA21	—	00000000h
PSA22	Each axis	60
PSA23	Each axis	3000
PSA24	Each axis	100
PSA25	Each axis	0
PSA26	Each axis	100
PSA27	Each axis	1000
PSA28	Each axis	1000
PSA29	—	0
PSA30	—	0
PSA31	—	0
PSA32	—	00000000h
PSA33	—	00000000h
PSA34	—	00000000h
PSA35	—	00000000h
PSA36	—	00000000h
PSA37	—	00000000h
PSA38	—	00000000h
PSA39	—	00000000h
PSA40	—	00000000h
PSA41	—	00000000h
PSA42	—	00000000h
PSA43	—	00000000h
PSA44	—	00000000h

No.	Setting method	Initial value
PSA45	—	00000000h
PSA46	—	00000000h
PSA47	—	00000000h
PSA48	—	00000000h
PSA49	—	00000000h
PSA50	—	00000000h
PSA51	—	00000000h
PSA52	—	00000000h
PSA53	—	00000000h
PSA54	—	00000000h
PSA55	—	00000000h
PSA56	—	00000000h
PSA57	—	00000000h
PSA58	—	00000000h
PSA59	—	00000000h
PSA60	—	00000000h
PSA61	—	00000000h
PSA62	—	00000000h
PSA63	—	00000000h
PSA64	—	00000000h

8.2 Safety sub-function 2 parameters group ([Pr. PSB_ _])

No.	Setting method	Initial value
PSB01	Each axis	00000000h
PSB02	Each axis	3
PSB03	—	00000000h
PSB04	—	00000000h
PSB05	—	00000000h
PSB06	Each axis	3
PSB07	—	00000000h
PSB08	—	00000000h
PSB09	—	00000000h
PSB10	Each axis	15.0
PSB11	Each axis	15.0
PSB12	Each axis	15.0
PSB13	Each axis	15.0
PSB14	Each axis	-15.0
PSB15	Each axis	-15.0
PSB16	Each axis	-15.0
PSB17	Each axis	-15.0
PSB18	Each axis	10
PSB19	—	100
PSB20	—	50
PSB21	—	0
PSB22	—	15.0
PSB23	—	-15.0
PSB24	—	10
PSB25	—	10
PSB26	—	00000000h
PSB27	—	00000000h
PSB28	—	00000000h
PSB29	—	00000000h
PSB30	—	00000000h
PSB31	—	00000000h
PSB32	—	00000000h
PSB33	—	00000000h
PSB34	—	00000000h
PSB35	—	00000000h
PSB36	—	00000000h
PSB37	—	00000000h
PSB38	—	00000000h
PSB39	—	00000000h
PSB40	—	00000000h
PSB41	—	00000000h
PSB42	—	00000000h
PSB43	—	00000000h
PSB44	—	00000000h
PSB45	—	00000000h
PSB46	—	00000000h
PSB47	—	00000000h
PSB48	—	00000000h

No.	Setting method	Initial value
PSB49	—	00000000h
PSB50	—	00000000h
PSB51	—	00000000h
PSB52	—	00000000h
PSB53	—	00000000h
PSB54	—	00000000h
PSB55	—	00000000h
PSB56	—	00000000h
PSB57	—	00000000h
PSB58	—	00000000h
PSB59	—	00000000h
PSB60	—	00000000h
PSB61	—	00000000h
PSB62	—	00000000h
PSB63	—	00000000h
PSB64	—	00000000h

8.3 Network parameters group ([Pr. PSC_ _])

No.	Setting method	Initial value
PSC01	Common	32
PSC02	—	00000000h
PSC03	Each axis	00000010h
PSC04	—	0
PSC05	Common	00000000h
PSC06	Common	FFFFFFFh
PSC07	Common	00000000h
PSC08	Each axis	00000000h
PSC09	Each axis	00000000h
PSC10	—	00000000h
PSC11	—	00000000h
PSC12	—	00000000h
PSC13	—	00000000h
PSC14	—	00000000h
PSC15	—	00000000h
PSC16	—	00000000h
PSC17	—	00000000h
PSC18	—	00000000h
PSC19	—	00000000h
PSC20	—	00000000h
PSC21	—	00000000h
PSC22	—	00000000h
PSC23	—	00000000h
PSC24	—	00000000h
PSC25	—	00000000h
PSC26	—	00000000h
PSC27	—	00000000h
PSC28	—	00000000h
PSC29	—	00000000h
PSC30	—	00000000h
PSC31	—	00000000h
PSC32	—	00000000h

8.4 Safety I/O device parameters group ([Pr. PSD_ _])

No.	Setting method	Initial value
PSD01	Each axis	00000000h
PSD02	Common	00000000h
PSD03	Common	00000000h
PSD04	Common	00000000h
PSD05	—	00000000h
PSD06	—	00000000h
PSD07	—	00000000h
PSD08	Common	00000000h
PSD09	Common	00000000h
PSD10	Common	00000000h
PSD11	—	00000000h
PSD12	Common	00000001h
PSD13	Common	00000001h
PSD14	Common	00000001h
PSD15	—	00000001h
PSD16	—	00000001h
PSD17	—	00000001h
PSD18	Common	20
PSD19	Common	20
PSD20	Common	20
PSD21	—	20
PSD22	—	20
PSD23	—	20
PSD24	Common	00001111h
PSD25	—	00000011h
PSD26	Common	00000001h
PSD27	Common	00001111h
PSD28	—	00000011h
PSD29	Common	00001111h
PSD30	Common	00000000h
PSD31	Common	00001111h
PSD32	—	00000000h
PSD33	—	00000000h
PSD34	—	00000000h
PSD35	—	00000000h
PSD36	—	00000000h
PSD37	—	00000000h
PSD38	—	00000000h
PSD39	—	00000000h
PSD40	—	00000000h
PSD41	—	00000000h
PSD42	—	00000000h
PSD43	—	00000000h
PSD44	—	00000000h
PSD45	—	00000000h
PSD46	—	00000000h
PSD47	—	00000000h
PSD48	—	00000000h
PSD49	—	00000000h
PSD50	—	00000000h

No.	Setting method	Initial value
PSD51	—	00000000h
PSD52	—	00000000h
PSD53	—	00000000h
PSD54	—	00000000h
PSD55	—	00000000h
PSD56	—	00000000h
PSD57	—	00000000h
PSD58	—	00000000h
PSD59	—	00000000h
PSD60	—	00000000h
PSD61	—	00000000h
PSD62	—	00000000h
PSD63	—	00000000h
PSD64	—	00000000h

8.5 Extension setting 3 parameters group ([Pr. PSL_ _])

No.	Setting method	Initial value
PSL01	—	00000000h
PSL02	Each axis	1000
PSL03	Each axis	1000
PSL04	—	00000000h
PSL05	—	00000000h
PSL06	—	00000000h
PSL07	—	00000000h
PSL08	—	00000000h
PSL09	—	00000000h
PSL10	—	00000000h
PSL11	—	00000000h
PSL12	—	00000000h
PSL13	—	00000000h
PSL14	—	00000000h
PSL15	—	00000000h
PSL16	—	00000000h
PSL17	—	00000000h
PSL18	—	00000000h
PSL19	—	00000000h
PSL20	—	00000000h
PSL21	—	00000000h
PSL22	—	00000000h
PSL23	—	00000000h
PSL24	—	00000000h
PSL25	—	00000000h
PSL26	—	00000000h
PSL27	—	00000000h
PSL28	—	00000000h
PSL29	—	00000000h
PSL30	—	00000000h
PSL31	—	00000000h
PSL32	—	00000000h

9 FUNCTIONAL SAFETY PARAMETER SETTING METHOD

9.1 Engineering software

Functional safety parameters can be set using the engineering software manufactured by Mitsubishi Electric (MR Configurator2).

Connect a personal computer and the servo amplifier via a USB cable or a network.

For details on how to set functional safety parameters, refer to Help or the manual for the engineering software.

REVISIONS

*The manual number is given on the bottom left of the back cover.

Revision date	*Manual number	Description
June 2019	SH(NA)-030308ENG-A	First edition
January 2020	SH(NA)-030308ENG-B	■Servo parameters related to the following functions are added: Profile mode, fully closed loop system, super trace control, scale measurement function, touch probe
July 2020	SH(NA)-030308ENG-C	■Servo parameters related to the following functions are added: Continuous operation to torque control mode, functional safety, A/B/Z-phase differential output type encoder, regenerative option, network function
October 2020	SH(NA)-030308ENG-D	■Servo parameters related to the following functions are added: Degree unit, regenerative option
March 2021	SH(NA)-030308ENG-E	■Servo parameters related to the following function are added: Positioning mode (point table method)
June 2021	SH(NA)-030308ENG-F	■MR-J5D_-_G_ is added. ■Servo parameters related to the following function are added: CC-Link IE Field Network Basic ■The following servo parameters are changed to the parameters for manufacturer setting: [Pr. PC81], [Pr. PC81.1]
July 2022	SH(NA)-030308ENG-G	■Servo parameters related to the following functions are added: Gain adjustment, input open-phase detection function, master-slave operation function, backlash estimation function, CC-Link IE TSN Class A
January 2023	SH(NA)-030308ENG-H	■Servo parameters related to the following function are added: Override function
July 2023	SH(NA)-030308ENG-J	■Servo parameters related to the following function are added: Functional safety and drive recorder
January 2024	SH(NA)-030308ENG-K	■Servo parameters related to the following function are added: Functional safety
July 2024	SH(NA)-030308ENG-L	■Servo parameters related to the following functions are added: Cyclic synchronous pressure mode, EtherCAT
January 2025	SH(NA)-030308ENG-M	■Servo parameters related to the following functions are added: EtherNet/IP, regenerative option

This manual confers no industrial property rights or any rights of any other kind, nor does it confer any patent licenses. Mitsubishi Electric Corporation cannot be held responsible for any problems involving industrial property rights which may occur as a result of using the contents noted in this manual.

© 2019 MITSUBISHI ELECTRIC CORPORATION

WARRANTY

Warranty

1. Warranty period and coverage

We will repair any failure or defect hereinafter referred to as "failure" in our FA equipment hereinafter referred to as the "Product" arisen during warranty period at no charge due to causes for which we are responsible through the distributor from which you purchased the Product or our service provider. However, we will charge the actual cost of dispatching our engineer for an on-site repair work on request by customer in Japan or overseas countries. We are not responsible for any on-site readjustment and/or trial run that may be required after a defective unit are repaired or replaced.

[Term]

For terms of warranty, please contact your original place of purchase.

[Limitations]

(1) You are requested to conduct an initial failure diagnosis by yourself, as a general rule.

It can also be carried out by us or our service company upon your request and the actual cost will be charged. However, it will not be charged if we are responsible for the cause of the failure.

(2) This limited warranty applies only when the condition, method, environment, etc. of use are in compliance with the terms and conditions and instructions that are set forth in the instruction manual and user manual for the Product and the caution label affixed to the Product.

(3) Even during the term of warranty, the repair cost will be charged on you in the following cases;

1. a failure caused by your improper storing or handling, carelessness or negligence, etc., and a failure caused by your hardware or software problem
2. a failure caused by any alteration, etc. to the Product made on your side without our approval
3. a failure which may be regarded as avoidable, if your equipment in which the Product is incorporated is equipped with a safety device required by applicable laws and has any function or structure considered to be indispensable according to a common sense in the industry
4. a failure which may be regarded as avoidable if consumable parts designated in the instruction manual, etc. are duly maintained and replaced
5. any replacement of consumable parts (battery, fan, smoothing capacitor, etc.)
6. a failure caused by external factors such as inevitable accidents, including without limitation fire and abnormal fluctuation of voltage, and acts of God, including without limitation earthquake, lightning and natural disasters
7. a failure generated by an unforeseeable cause with a scientific technology that was not available at the time of the shipment of the Product from our company
8. any other failures which we are not responsible for or which you acknowledge we are not responsible for

2. Term of warranty after the stop of production

(1) We may accept the repair at charge for another seven (7) years after the production of the product is discontinued. The announcement of the stop of production for each model can be seen in our Sales and Service, etc.

(2) Please note that the Product (including its spare parts) cannot be ordered after its stop of production.

3. Service in overseas countries

Our regional FA Center in overseas countries will accept the repair work of the Product. However, the terms and conditions of the repair work may differ depending on each FA Center. Please ask your local FA center for details.

4. Exclusion of loss in opportunity and secondary loss from warranty liability

Regardless of the gratis warranty term, Mitsubishi shall not be liable for compensation to:

- (1) Damages caused by any cause found not to be the responsibility of Mitsubishi.
- (2) Loss in opportunity, lost profits incurred to the user by Failures of Mitsubishi products.
- (3) Special damages and secondary damages whether foreseeable or not, compensation for accidents, and compensation for damages to products other than Mitsubishi products.
- (4) Replacement by the user, maintenance of on-site equipment, start-up test run and other tasks.

5. Change of Product specifications

Specifications listed in our catalogs, manuals or technical documents may be changed without notice.

6. Application and use of the Product

- (1) For the use of our AC Servo, its applications should be those that may not result in a serious damage even if any failure or malfunction occurs in AC Servo, and a backup or fail-safe function should operate on an external system to AC Servo when any failure or malfunction occurs.
- (2) Our AC Servo is designed and manufactured as a general purpose product for use at general industries. Therefore, applications substantially influential on the public interest for such as atomic power plants and other power plants of electric power companies, and also which require a special quality assurance system, including applications for railway companies and government or public offices are not recommended, and we assume no responsibility for any failure caused by these applications when used.
In addition, applications which may be substantially influential to human lives or properties for such as airlines, medical treatments, railway service, incineration and fuel systems, man-operated material handling equipment, entertainment machines, safety machines, etc. are not recommended, and we assume no responsibility for any failure caused by these applications when used. We will review the acceptability of the abovementioned applications, if you agree not to require a specific quality for a specific application. Please contact us for consultation.
- (3) Mitsubishi Electric shall have no responsibility or liability for any problems involving programmable controller trouble and system trouble caused by DoS attacks, unauthorized access, computer viruses, and other cyberattacks.

TRADEMARKS

MELSERVO is a trademark or registered trademark of Mitsubishi Electric Corporation in Japan and/or other countries. All other product names and company names are trademarks or registered trademarks of their respective companies.

SH(NA)-030308ENG-M(2501)MEE

MODEL:

MODEL CODE:

MITSUBISHI ELECTRIC CORPORATION

HEAD OFFICE: TOKYO BLDG., 2-7-3, MARUNOUCHI, CHIYODA-KU, TOKYO 100-8310, JAPAN
NAGOYA WORKS: 1-14, YADA-MINAMI 5-CHOME, HIGASHI-KU, NAGOYA 461-8670, JAPAN

When exported from Japan, this manual does not require application to the
Ministry of Economy, Trade and Industry for service transaction permission.

Specifications subject to change without notice.

Compliance with the indicated global standards and regulations is current as of the release date of this manual.