



Mitsubishi Electric AC Servo System

MITSUBISHI ELECTRIC SERVO SYSTEM
MELSERVO-JET

MR-JET-G-N1
User's Manual
(Communication Function)



-MR-JET-_G_-_N1

SAFETY INSTRUCTIONS

Please read the instructions carefully before using the equipment.

To use the equipment correctly, do not attempt to install, operate, maintain, or inspect the equipment until you have read through this manual, installation guide, and appended documents carefully. Do not use the equipment until you have a full knowledge of the equipment, safety information and instructions.





In this manual, the safety instruction levels are classified into "WARNING" and "CAUTION".

 WARNING	Indicates that incorrect handling may cause hazardous conditions, resulting in death or severe injury.
 CAUTION	Indicates that incorrect handling may cause hazardous conditions, resulting in medium or slight injury.

Note that the CAUTION level may lead to a serious consequence depending on conditions.

Please follow the instructions of both levels because they are important to personnel safety.

Forbidden actions and required actions are indicated by the following diagrammatic symbols.

	Indicates a forbidden action. For example, "No Fire" is indicated by  .
	Indicates a required action. For example, grounding is indicated by  .

In this manual, precautions for hazards that can lead to property damage, instructions for other functions, and other information are shown separately in the "Point" area.

After reading this manual, keep it accessible to the operator.

[Installation/wiring]

WARNING

- * To prevent an electric shock, turn off the power and wait for 15 minutes or more before starting wiring and/or inspection.
 - * To prevent an electric shock, ground the servo amplifier.
 - * To prevent an electric shock, any person who is involved in wiring should be fully competent to do the work.
 - ! To prevent an electric shock, mount the servo amplifier before wiring.
 - * To prevent an electric shock, connect the protective earth (PE) terminal of the servo amplifier to the protective earth (PE) of the cabinet, then connect the grounding lead wire to the ground.
 - To prevent an electric shock, do not touch the conductive parts.
-

[Setting/adjustment]

WARNING

- * To prevent an electric shock, do not operate the switches with wet hands.
-

[Operation]

WARNING

- * To prevent an electric shock, do not operate the switches with wet hands.
-

[Maintenance]

WARNING

- * To prevent an electric shock, any person who is involved in inspection should be fully competent to do the work.
 - ❖ To prevent an electric shock, do not operate the switches with wet hands.
-

ABOUT THE MANUAL

Point

e-Manuals are Mitsubishi Electric FA electronic book manuals that can be browsed with a dedicated tool.

e-Manuals enable the following:

- Searching for desired information in multiple manuals at the same time (manual cross searching)
- Jumping from a link in a manual to another manual for reference
- Browsing for hardware specifications by scrolling over the components shown in product illustrations
- Bookmarking frequently referenced information
- Copying sample programs to engineering software

If using the servo for the first time, prepare and use the following related manuals to ensure that the servo is used safely. For the related manuals, refer to the User's Manual (Introduction).

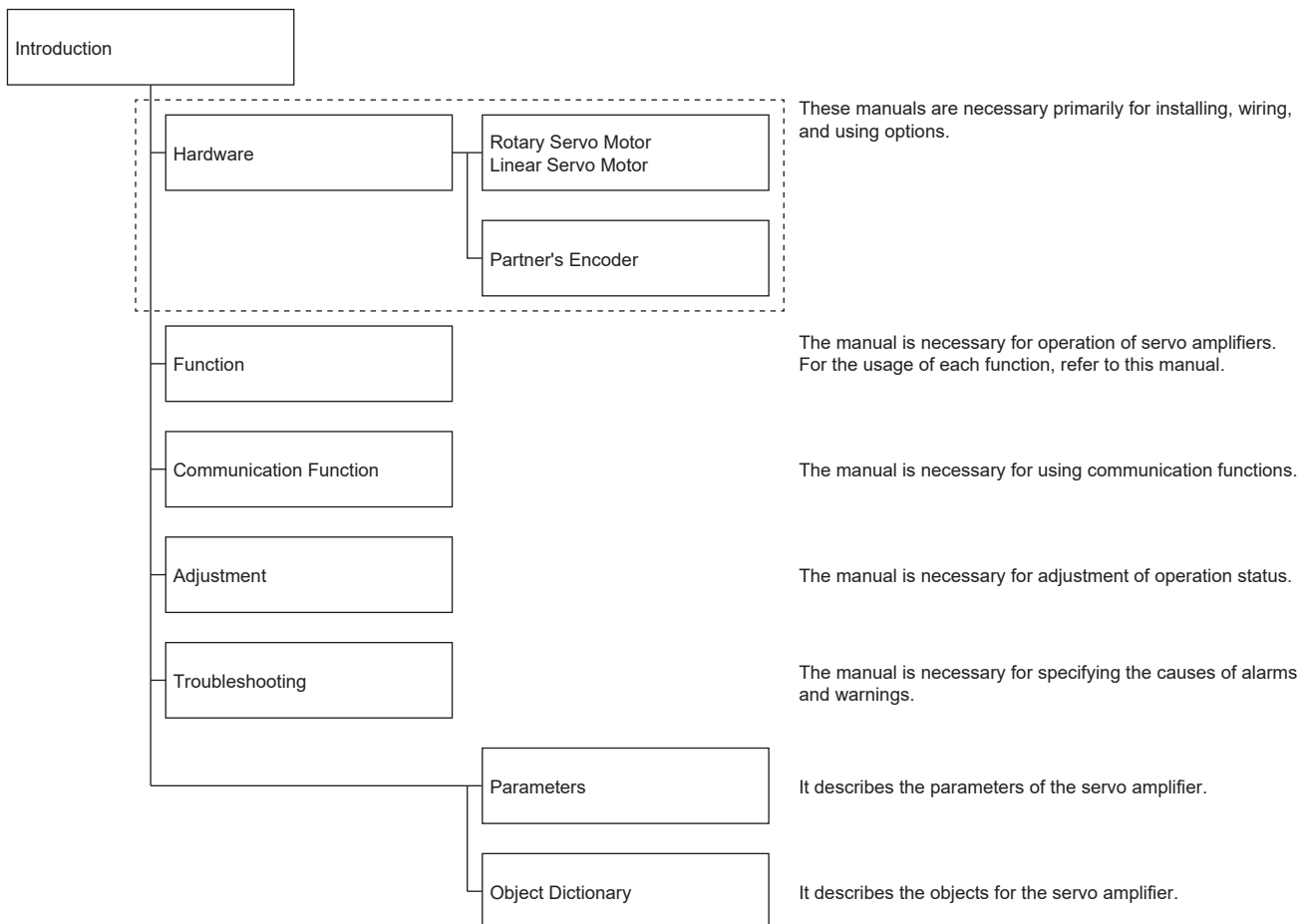

Global standards and regulations

Compliance with the indicated global standards and regulations is current as of the release date of this manual. Some standards and regulations may have been modified or withdrawn.

U.S. CUSTOMARY UNITS

U.S. customary units are not shown in this manual. Convert the values if necessary according to the following table.

Quantity	SI (metric) unit	U.S. customary unit
Mass	1 [kg]	2.2046 [lb]
Length	1 [mm]	0.03937 [inch]
Torque	1 [N•m]	141.6 [oz•inch]
Moment of inertia	1 [$\times 10^{-4}$ kg•m ²]	5.4675 [oz•inch ²]
Load (thrust load/axial load)	1 [N]	0.2248 [lbf]
Temperature	N [$^{\circ}$ C] \times 9/5 + 32	N [$^{\circ}$ F]

CONTENTS

SAFETY INSTRUCTIONS	1
ABOUT THE MANUAL	3
U.S. CUSTOMARY UNITS	4
CHAPTER 1 FUNCTIONS AND CONFIGURATION	7
1.1 Outline	7
CiA 402 drive profile	7
Control mode	8
1.2 Function list	9
1.3 Engineering software	9
Engineering software list	9
Connection via a controller	9
CHAPTER 2 EtherCAT COMMUNICATION	10
2.1 Communication specifications	10
2.2 EtherCAT State Machine (ESM)	11
Communication state	11
EtherCAT state	12
CHAPTER 3 OBJECT DICTIONARY (OD)	13
3.1 Section definition of object dictionary	13
3.2 Saving object dictionary data	15
Store parameters	15
Restore default parameters	15
CHAPTER 4 PDO (Process Data Object) COMMUNICATION	16
4.1 PDO communication cycle	16
4.2 PDO setting-related objects	16
4.3 PDO default mapping	17
RxPDO default mapping	17
TxPDO default mapping	19
4.4 Variable PDO mapping	20
4.5 Objects that require mapping	22
RxPDO	22
TxPDO	22
CHAPTER 5 SDO (Service Data Object) COMMUNICATION	23
5.1 SDO communication-related services	23
5.2 SDO Abort Code	24
CHAPTER 6 SYNCHRONIZATION	25
6.1 Availability of synchronous mode in control mode	25
6.2 Synchronous mode (DC mode)	25
6.3 Asynchronous mode (Free-run mode)	26
CHAPTER 7 CiA 402 DRIVE PROFILE	27
7.1 PDS state transitions	27

7.2	Controlword/Control DI	29
	Bit definition of Controlword	29
	Bit definition of Control DI	30
7.3	Statusword/Status DO	35
	Bit definition of Statusword	36
	Bit definition of Status DO	37
7.4	Control mode	42
	Selecting control mode (Modes of operation)	42
	Control switching	43
 CHAPTER 8 STARTUP		 45
<hr/>		
8.1	Absolute position detection system configuration	45
	Outline	45
	Precautions and restrictions	45
	Startup procedure	46
8.2	Connecting Ethernet cables	47
8.3	Example set-up procedure	48
	Controller settings	48
	Establishing the communication	50
	Operating the servo motor	50
	Disconnecting the network	50
 CHAPTER 9 MANUFACTURER-SPECIFIC FUNCTION		 51
<hr/>		
9.1	Torque limit selection	51
	Torque limit	51
9.2	Infinite feed function	52
	Outline	52
	Setting method	52
	When the servo motor rotates 32768 rev or more	52
	Restrictions	53
9.3	Safety communication function	54
	Safety PDO mapping	54
	Safety parameter set	55
	Startup	55
	I/O function	57
	REVISIONS	62
	WARRANTY	63
	TRADEMARKS	64

1 FUNCTIONS AND CONFIGURATION

1.1 Outline

EtherCAT is an abbreviation of Ethernet for Control Automation Technology. It is open network communication between a master station and slave stations via real-time Ethernet developed by Beckhoff Automation. ETG (EtherCAT Technology Group) manages EtherCAT.

The servo amplifiers operate as slave stations which support the CAN application protocol over EtherCAT (CoE). The device type corresponds to a power drive system, and supports the CiA 402 drive profile.

CiA 402 drive profile

The servo amplifiers operate as slave stations which support the CAN application protocol over EtherCAT (CoE). The device type corresponds to a power drive system, and supports the CiA 402 drive profile.

Control mode

The servo amplifier supports the following control modes.

Control mode	Symbol	Description
Cyclic synchronous position mode	csp	This is a control mode to drive servo motors by receiving a position command cyclically via either synchronous or asynchronous communication with a controller. Use an absolute position address for the command.
Cyclic synchronous velocity mode	csv	This is a control mode to drive servo motors by receiving a speed command cyclically via either synchronous or asynchronous communication with a controller.
Cyclic synchronous torque mode	cst	This is a control mode to drive servo motors by receiving a torque command cyclically via either synchronous or asynchronous communication with a controller.
Profile position mode	pp	This is a position control mode where an end position command is received to drive the servo motor in either the synchronous or asynchronous communication with a controller. Use an absolute position address or a relative position address for the command.
Profile velocity mode	pv	This is a control mode to drive servo motors by receiving a target speed command via either synchronous or asynchronous communication with a controller.
Profile torque mode	tq	This is a control mode to drive servo motors by receiving a target torque command via either synchronous or asynchronous communication with a controller.
Point table mode	pt	This is a control mode to drive servo motors according to commands such as travel distance and speed which are stored in the point table number specified via either synchronous or asynchronous communication with a controller. This control mode is not in CiA 402 standard (Mitsubishi Electric original). Available on servo amplifiers with firmware version B8 or later.
JOG operation mode	jj	This is a control mode where the servo motor speed is set to drive the servo motor manually via either synchronous or asynchronous communication with a controller. This control mode is not in CiA 402 standard (Mitsubishi Electric original). Available on servo amplifiers with firmware version B8 or later.
Homing mode	hm	This is a control mode to perform homing with the method specified by the controller.

Compliance with standards

The servo amplifiers comply with the standards shown below. For the descriptions which are not in this manual, refer to the following standards.

Standards	Version
ETG.1000.2 EtherCAT Specification - Part2 Physical Layer service definition and protocol specification	V1.0.4
ETG.1000.3 EtherCAT Specification - Part3 Data Link Layer service definition	V1.0.4
ETG.1000.4 EtherCAT Specification - Part4 Data Link Layer protocol specification	V1.0.4
ETG.1000.5 EtherCAT Specification - Part5 Application Layer service definition	V1.0.4
ETG.1000.6 EtherCAT Specification - Part6 Application Layer protocol specification	V1.0.4
ETG.1020 EtherCAT Protocol Enhancements	V1.2.0
ETG.1300 EtherCAT Indicator and Labeling Specification	V1.1.1
ETG.2000 EtherCAT Slave Information (ESI) Specification	V1.0.10
ETG.6010 Implementation Directive for CiA 402 Drive Profile	V1.1.0
ETG.5003.1 Semiconductor Device Profile - part1 CommonDeviceProfile* ¹	V1.1.0
ETG.5003.2 Semiconductor Device Profile - part2 Firmware Update	V1.0.1
ETG.5001.4 EtherCAT Modular Device Profile - part4 Safety Modules Specification	V1.1.0
ETG.5100 Safety over EtherCAT Protocol Specification	V1.2.0
IEC 61800-7-201 Adjustable speed electrical power drive systems – Part 7-201: Generic interface and use of profiles for power drive systems – Profile type 1 specification	Edition 2.0
Adjustable speed electrical power drive systems – Part 7-301: Generic interface and use of profiles for power drive systems – Mapping of profile type 1 to network technologies	Edition 2.0

*1 It complies with the items in CDP (CommonDeviceProfile) in the standards for servo amplifiers with firmware version D4 or later.

1.2 Function list

This list explains the EtherCAT related functions for devices and the whole system.

Category	Subcategory	Function	Description	Detailed explanation
Network	Open network	EtherCAT protocol	This protocol supports EtherCAT.	☞ Page 10 Communication specifications
		EtherCAT communication setting	This setting specifies the control mode and network communication.	☞ Page 45 STARTUP
	Remote maintenance	File access over EtherCAT (FoE)	This protocol enables a firmware upload to devices via a network. For details, contact your local sales office.	—
		Ethernet over EtherCAT (EoE)	This protocol transmits the Ethernet communication data via the EtherCAT segment.	☞ Page 9 Connection via a controller
	Profile	ESI	This is a setting file on which the information specific to each slave station (vendor information, product information, profiles, objects, and other information) is written. Store the ESI file on the controller to use it.	—
Application function	Synchronization	Distributed clock (DC)	This function enables DC mode.	☞ Page 25 SYNCHRONIZATION

1.3 Engineering software

The following explains the main purposes of the engineering software used in communication. For specific usages, refer to the manuals of the engineering software and controller.

Engineering software list

This list shows engineering software to be used.

Engineering software	Detailed explanation
MR Configurator2	This is a software that has the following functions: servo amplifier adjustment, monitor display, diagnosis, reading/writing of servo parameters, and test operation. These functions are performed using a personal computer. Parameter settings and test operation can also be performed via a controller. Settings, such as a stroke limit, absolute position detection system, communication error detection time, are made with this software.

Connection via a controller

Connection via a controller is available on servo amplifiers with firmware version C4 or later being used with MR Configurator2 with software version 1.134Q or later.

The Ethernet over EtherCAT (EoE) function of EtherCAT network allows the engineering software to be connected with the servo amplifier via a controller.

A controller that supports the EoE function (EtherCAT master) is required.

For the usage of the EoE function, refer to the manual for the controller being used.

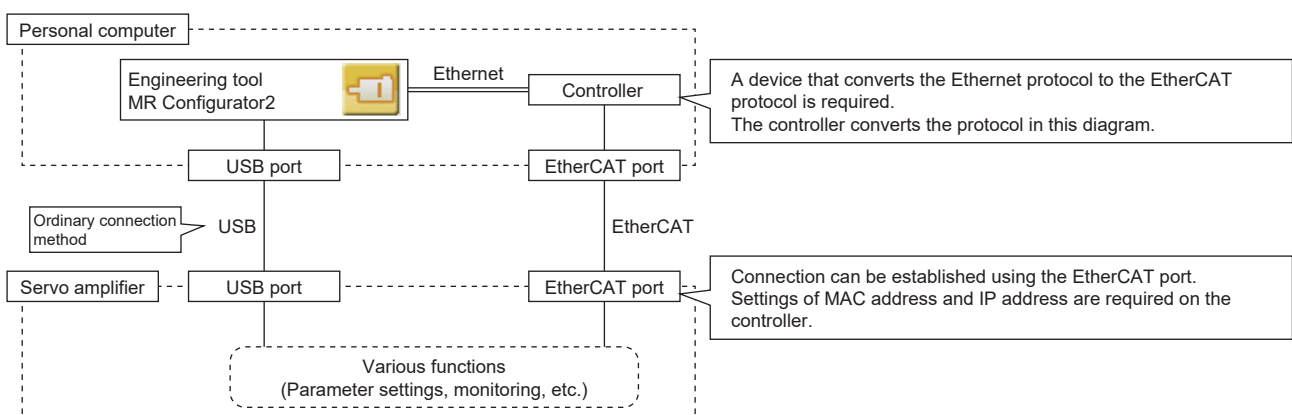

2 EtherCAT COMMUNICATION

2.1 Communication specifications

The communication specifications are shown in the following table.

Item	Description	Remark
EtherCAT communication specifications	IEC 61158 Type12 CAN application protocol over EtherCAT (CoE), IEC 61800-7 CiA 402 Drive Profile	—
Physical layer	100BASE-TX (IEEE802.3)	—
Communication connector	Two RJ45 ports (IN port and OUT port)	—
Communication cable	Cable type	Category 5e or higher, (double shielded/STP) straight cable
	Standard	One of the following standards must be met. • IEEE802.3 100BASE-TX • ANSI/TIA/EIA-568-B (Category 5e)
	Connector	RJ-45 shielded connector
Network topology	Line, Tree, Star, or Hybrid of these three topology types	—
Communication speed	100 Mbps (Full duplex)	—
Transmission distance between stations	Max. 100 m	—
Number of connection nodes	Max. 65535	The number of connection nodes for actual use varies depending on the specifications of the master controller.
SDO (Mailbox) communication	Asynchronous communication Sending/Receiving: 1 channel each	Maximum data size in sending/receiving: 1486 bytes per channel
PDO (Process Data) communication ^{*1}	Cycle time: Select from 0.125 ms, 0.25 ms, 0.5 ms, 1 ms, 2 ms, 4 ms, or 8 ms. Receive PDO (RxPDO): 1 channel Send PDO (TxPDO): 1 channel	—
PDO mapping	The servo amplifiers support variable PDO mapping.	Maximum size of RxPDO and TxPDO: 64 bytes each Maximum number of object mapping: 32 each Maximum number of object mapping (safety PDO when the safety communication function is used): 36 each
Distributed clock (DC)	DC mode or Free-run mode can be selected.	Sync0: Set for the same cycle time as the PDO communication cycle Sync1: Not used
Explicit Device Identification	Supported	—
LED display	RUN, ERROR, LINK/Activity (IN, OUT)	—

*1 There are restrictions on the communication cycle depending on the function used. For details, refer to "Restrictions on the MR-JET-G_" in the following manual.

 MR-JET-G-N1 User's Manual (Introduction)

2.2 EtherCAT State Machine (ESM)

The communication states of the MR-JET-_G-N1 servo amplifier are classified and managed by EtherCAT State Machine (ESM) which is defined in the EtherCAT standard.

Communication state

Communication states are classified as shown in the table below. There are two types of communication: PDO communication (process data object) in which command data and feedback data are transmitted and received cyclically, and SDO communication (service data object) in which object data is transmitted and received asynchronously.

☞ Page 16 PDO (Process Data Object) COMMUNICATION

☞ Page 23 SDO (Service Data Object) COMMUNICATION

ESM state	Description
Init	The ESM state after turning on the power is the Init state. No SDO communication or PDO communication is possible. The master station accesses the DL-Information registers and initializes the communication.
Pre-Operational	SDO communication is possible. PDO communication is not possible. Initial network settings are configured and the initial transfer of parameters are made in this state.
Safe-Operational	SDO communication is possible. PDO communication is also possible, although all the operations (commands) such as driving servo motors are disabled. When the DC mode is selected, synchronization is established in this state.
Operational	Both the SDO communication and the PDO communication are possible. Commanding via PDO communication is enabled, and servo motors can be driven.
Bootstrap	Mailbox communication via the FoE protocol is possible. This is a state in which the firmware is updated via EtherCAT. (For manufacturer setting)

EtherCAT state

The servo amplifier can be operated once the state transitions from the Init state through the Pre-Operational and Safe-Operational state to the Operational state. When the Operational state transitions to other states, initialization of the servo amplifier is executed to clear internal statuses.

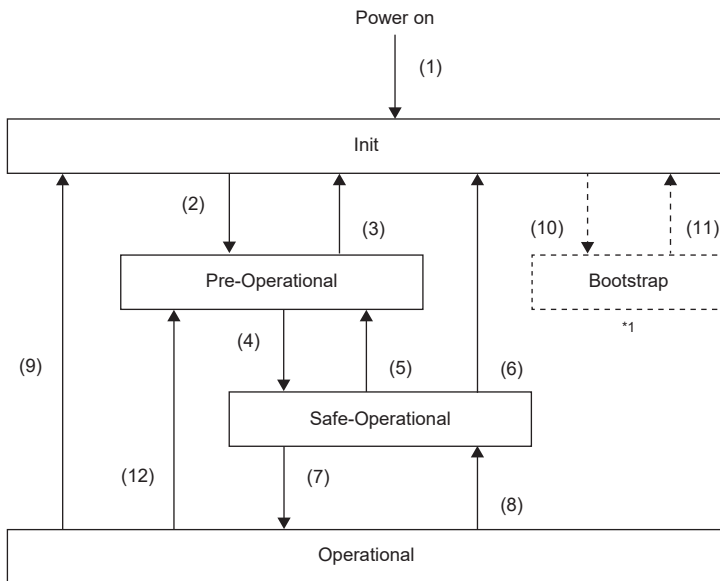

*1 This state is for manufacturer's settings.

Transition No.	Description
(1)	Power-on
(2)	SDO communication configuration <ul style="list-style-type: none"> The master station sets Sync Manager channels for SDO communication and DL Address registers of the slave station. The master station requests the slave station to transition to the Pre-Operational state. The state transitions to the Pre-Operational state.
(4)	PDO communication configuration <ul style="list-style-type: none"> The master station sets configuration parameters (such as PDO mapping) using SDO communication. The master station sets Sync Manager channels for PDO communication and FMMU channels of the slave station. FMMU (Fieldbus Memory Management Unit) is a mechanism to manage the relationship between the global address space and the local address space in EtherCAT communication. The global address space is used for PDO communication, and the local address space in each slave station stores object data. The master station requests the slave station to transition to the Safe-Operational state. The state transitions to the Safe-Operational state.
(7)	Synchronization <ul style="list-style-type: none"> The master station and the slave station synchronize with each other by using Distributed Clocks. The master station starts to output a valid command value. The master station requests the slave station to transition to the Operational state. The state transitions to the Operational state.
(5), (12)	When the master station requests the slave station to transition to the Pre-Operational state, the state transitions to the Pre-Operational state.
(8)	When the master station requests the slave station to transition to the Safe-Operational state, the state transitions to the Safe-Operational state.
(3), (6), (9), (11)	In the following case, the state transitions to the Init state. When the master station requests the slave station to transition to the Init state.
(10)	When the master station requests the slave station to transition to the Bootstrap state, the state transitions to the Bootstrap state.

3 OBJECT DICTIONARY (OD)

Point 

For details of the object dictionary, refer to the following manual.

 [IMR-JET-G-N1 User's Manual \(Object Dictionary\)](#)

The data that a CAN application protocol over EtherCAT (CoE) device holds, such as control parameters, command values, and feedback values, is handled as an object composed of an Index value, object name, object type, R/W attribute, and other elements. The data is exchanged between the master and slave devices. The aggregate of these objects is called an object dictionary (OD).

3.1 Section definition of object dictionary

With the CoE protocol (CAN application protocol over EtherCAT), objects of an object dictionary are categorized by Index depending on the descriptions as shown in the following table.

The objects of the Semiconductor device profile (Index F000h to F0FFh) are available on servo amplifiers with firmware version D4 or later.

Index	Description
1000h to 1FFFh	Communication profile
2000h to 4FFFh	Objects group defined by Mitsubishi Electric
6000h to 77FFh	CiA 402 drive profile
F000h to F0FFh	Semiconductor device profile

The following shows the section definition of object dictionary when the safety communication function is used.





The following definitions are added to the section definition (CAN application protocol over EtherCAT (CoE)).

Indexes F000h to FFFFh change to the objects of the FSoE device profile when the safety communication function is used.





They can only have either of the FSoE device profile definition and the Semiconductor device profile definition.

Index	Description
1608h 1A08h	Communication profile
E600h E700h E900h to E9FFh F601h to F60Fh F700h to F70Fh	FSoE CiA 402 drive profile
F000h to FFFFh	Modular device profile

All objects of an object dictionary follow the definitions specified in the standards. The correspondence between indexes and the object contents is shown in the following table. Refer to the Reference column for the details of each object.

Index	Description	Reference
0000h to 0FFFh	Data type area	—
1000h to 1FFFh	CoE communication area	 Page 16 PDO (Process Data Object) COMMUNICATION  Page 23 SDO (Service Data Object) COMMUNICATION  IMR-JET-G-N1 User's Manual (Object Dictionary)
2000h to 25FFh	Servo parameter area (manufacturer specific)	 IMR-JET-G-N1 User's Manual (Object Dictionary)
2A00h to 2FFFh	Servo control command/monitor area (manufacturer specific)	
6000h to 67FFh	CiA 402 drive profile area	
F000h to F0FFh	Semiconductor device profile area	

The correspondence between indexes and the object contents when the safety communication function is used is shown in the following table. The following definition is added. Indexes F000h to FFFFh change to the objects of the FSoE device profile when the safety communication function is used. They can only have either of the FSoE device profile definition and the Semiconductor device profile definition. Refer to the Reference column for the details of each object.

Index	Description	Reference
1608h 1A08h	CoE communication area	 Page 16 PDO (Process Data Object) COMMUNICATION  Page 23 SDO (Service Data Object) COMMUNICATION  IMR-JET-G-N1 User's Manual (Object Dictionary)
E600h	FSoE CiA 402 drive profile area (FSoE Input area)	 IMR-JET-G-N1 User's Manual (Object Dictionary)
E700h	FSoE CiA 402 drive profile area (FSoE Output area)	
E900h to E90Fh	FSoE CiA 402 drive profile area (FSoE Information area)	
F601h to F60Fh	FSoE the CiA 402 drive profile area (FSoE Input area)	
F701h to F70Fh	FSoE CiA 402 drive profile area (FSoE Output area)	
F000h to FFFFh	Modular device profile area	

3.2 Saving object dictionary data

Some of object dictionary data is stored in a non-volatile memory and some is not. Use [Store parameters (Obj. 1010h)] for storing the object dictionary data in the non-volatile memory.

For details about objects that can be stored in the non-volatile memory, refer to the following manual.

 IMR-JET-G-N1 User's Manual (Object Dictionary)

Store parameters

Writing "65766173h" (= reverse order of the ASCII code "save") to [Save all parameters (Obj. 1010h: 01h)] enables the setting value of an object to be stored in the non-volatile memory of the servo amplifier.

It can take up to around 25 s for [Save all parameters (Obj. 1010h: 01h)] to write all the parameters. Do not shut off the power supply during writing.

Index	Sub	Object	Name	Data Type	Access	Description
1010h	0	ARRAY	Store parameters	U8	ro	Number of entries
	1		Save all parameters	U32	rw	Saves all parameters.

Reading [Save all parameters (Obj. 1010h: 01h)] will produce the following values. Bit 0 is "0" during saving and "1" when not saving.

Bit	Description
0	0: Object cannot be saved by the command (save in progress) 1: Object can be saved by the command (save not in progress)
1	0: Not automatically saved

Precautions

To shut off the power supply after executing Store parameters, make sure that a save is not in progress (Bit 0 is on), then shut off the power.

Restore default parameters

Objects can be reset to the factory setting.

To initialize objects, write "64616F6Ch" (= reverse order of the ASCII code "load") to [Restore all default parameters (Obj. 1011h: 01h)], then cycle the power. Writing a value other than "load" (= 64616F6Ch) triggers an error. Initialization can take up to around 25 s.

Index	Sub	Object	Name	Data Type	Access	Description
1011h	0	ARRAY	Restore default parameters	U8	ro	Number of entries
	1		Restore all default parameters	U32	rw	All parameter initialization

Reading [Restore all default parameters (Obj. 1011h: 01h)] will display "00000001h" (command valid).

4 PDO (Process Data Object) COMMUNICATION

In PDO (Process Data Object) communication, command data and feedback data can be transmitted and received cyclically between a master station (controller) and a slave station (servo amplifier). PDOs are distinguished into RxPDOs and TxPDOs. An RxPDO is used when the slave station receives command data from the controller, and a TxPDO is used when the slave station transmits status data to the controller with TxPDOs.

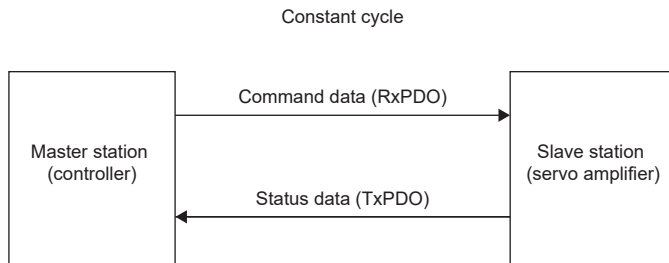

The variable PDO mapping function enables PDO communication to transmit and receive multiple PDOs in any array at a time.

4.1 PDO communication cycle

RxPDO communication and TxPDO communication are performed at the same cycle on the servo amplifier. To change the communication cycle time, rewrite [Cycle Time (Obj. 1C32h: 02h)] with SDO download in the Pre-Operational state via a network.

4.2 PDO setting-related objects

Objects related to PDO settings are shown in the following table.

Index	Sub	Object	Name	Data Type	Access	Description
1C32h	0	RECORD	SM output parameter	U8	ro	MR-JET-G-N1 User's Manual (Object Dictionary)
	1		Synchronization Type	U16	rw	
	2		Cycle time	U32	rw	
	4		Synchronization types supported	U16	ro	
	5		Minimum cycle time	U32	ro	
	6		Calc and copy time	U32	ro	
	9		Delay time	U32	ro	
	11		SM-Event Missed	U16	ro	
	12		Cycle time too small	U16	ro	
	13		Shift Time Too Short	U16	ro	
	32		Sync Error	BOOL	ro	
	1C33h		0	RECORD	SM input parameter	
1		Synchronization type	U16		rw	
2		Cycle time	U32		rw	
4		Synchronization types supported	U16		ro	
5		Minimum cycle time	U32		ro	
6		Calc and copy time	U32		ro	
9		Delay time	U32		ro	
11		SM-Event Missed	U16		ro	
12		Cycle time too small	U16		ro	
13		Shift Time Too Short	U16		ro	
32		Sync Error	BOOL		ro	

4.3 PDO default mapping

Point

The servo amplifier supports the variable PDO mapping function, which can select objects transmitted and received in PDO communication. For changing the PDO mapping, refer to the following.

☞ Page 20 Variable PDO mapping

RxPDO default mapping

With the RxPDO default mapping, a master station (controller) transmits command data to a slave station (servo amplifier) using an RxPDO in the array shown in the following table.

Map No.	Initial mapping settings	Applications expected to be used for initial mapping
1st RxPDO map (1600h)	Modes of operation (Obj. 6060h) Padding (1 byte) Controlword (Obj. 6040h) Control DI 1 (Obj. 2D01h) Control DI 2 (Obj. 2D02h) Control DI 3 (Obj. 2D03h) Target position (Obj. 607Ah) Target velocity (Obj. 60FFh) Velocity limit value (Obj. 2D20h) Target torque (Obj. 6071h)	Cyclic synchronous position mode (csp) Cyclic synchronous velocity mode (csv) Cyclic synchronous torque mode (cst) Homing mode (hm) This initial mapping is for an application in which the modes above are switched and used. The following function can be used together. • Speed limit function (in cst) Map size: 24 bytes
2nd RxPDO map (1601h)	Modes of operation (Obj. 6060h) Padding (1 byte) Controlword (Obj. 6040h) Control DI 1 (Obj. 2D01h) Control DI 2 (Obj. 2D02h) Control DI 3 (Obj. 2D03h) Target position (Obj. 607Ah) Target velocity (Obj. 60FFh) Velocity limit value (Obj. 2D20h) Target torque (Obj. 6071h) Profile velocity (Obj. 6081h) Profile acceleration (Obj. 6083h) Profile deceleration (Obj. 6084h) Torque slope (Obj. 6087h)	Profile position mode (pp) Profile velocity mode (pv) Profile torque mode (tq) Homing mode (hm) This initial mapping is for an application in which the modes above are switched and used. The following function can be used together. • Speed limit function (in tq) Map size: 42 bytes
3rd RxPDO map (1602h)	Modes of operation (Obj. 6060h) Padding (1 byte) Controlword (Obj. 6040h) Control DI 1 (Obj. 2D01h) Control DI 2 (Obj. 2D02h) Control DI 3 (Obj. 2D03h) Target point table (Obj. 2D60h) Profile velocity (Obj. 6081h) Profile acceleration (Obj. 6083h) Profile deceleration (Obj. 6084h)	Point table mode (pt) JOG operation mode (jg) Homing mode (hm) This initial mapping is for an application in which the modes above are switched and used. Map size: 24 bytes
4th RxPDO map (1603h)	Unassigned	—

Map No.	Initial mapping settings	Applications expected to be used for initial mapping
9th RxPDO map (1608h)	FSoE Master Command (Obj. E700h: 01h) STO Command (Obj. F701h: 01h) SS1 Command (Obj. F701h: 02h) Padding (2 bit) SDIP Command (Obj. F701h: 04h) SDIN Command (Obj. F701h: 05h) Error Ack (Obj. F701h: 06h) SLS1 Command (Obj. F701h: 07h) SLS2 Command (Obj. F701h: 08h) SLS3 Command (Obj. F701h: 09h) SLS4 Command (Obj. F701h: 0Ah) SLT1 Command (Obj. F701h: 0Ch) SLT2 Command (Obj. F701h: 0Dh) SLT3 Command (Obj. F701h: 0Eh) FSoE Master CRC_0 (Obj. E700h: 03h) SLT4 Command (Obj. F701h: 0Fh) Padding (15 bit) FSoE Master CRC_1 (Obj. E700h: 04h) FSoE Master ConnectionID (Obj. E700h: 02h)	This initial mapping is for an application in which the safety communication function is used. Map size: 11 bytes

TxPDO default mapping

With the TxPDO default mapping, status data is transmitted to a master station (controller) using a TxPDO in the array shown in the following table.

Map No.	Initial mapping settings	Applications expected to be used for initial mapping
1st TxPDO map (1A00h)	Modes of operation display (Obj. 6061h) Padding (1 byte) Statusword (Obj. 6041h) Status DO 1 (Obj. 2D11h) Status DO 2 (Obj. 2D12h) Status DO 3 (Obj. 2D13h) Position actual value (Obj. 6064h) Velocity actual value (Obj. 606Ch) Following error actual value (Obj. 60F4h) Torque actual value (Obj. 6077h)	Cyclic synchronous position mode (csp) Cyclic synchronous velocity mode (csv) Cyclic synchronous torque mode (cst) Homing mode (hm) This initial mapping is for an application in which the modes above are switched and used. This mapping is also for an application in which the following modes are switched and used. <ul style="list-style-type: none"> • Profile position mode (pp) • Profile velocity mode (pv) • Profile torque mode (tq) • Homing mode (hm) Map size: 24 bytes
2nd TxPDO map (1A01h)	Modes of operation (Obj. 6060h) Padding (1 byte) Statusword (Obj. 6041h) Status DO 1 (Obj. 2D11h) Status DO 2 (Obj. 2D12h) Status DO 3 (Obj. 2D13h) Status DO 5 (Obj. 2D15h) Status DO 7 (Obj. 2D17h) Position actual value (Obj. 6064h) Velocity actual value (Obj. 606Ch) Following error actual value (Obj. 60F4h) Torque actual value (Obj. 6077h) M code actual value (Obj. 2D6Ah) Padding (1 byte) Point demand value (Obj. 2D68h) Point actual value (Obj. 2D69h)	Point table mode (pt) JOG operation mode (jg) Homing mode (hm) This initial mapping is for an application in which the modes above are switched and used. Map size: 34 bytes
3rd TxPDO map (1A02h)	Unassigned	—
4th TxPDO map (1A03h)	Unassigned	—
9th TxPDO map (1A08h)	FSoE Slave Command (Obj. E600h: 01h) STO Status (Obj. F601h: 01h) SSM Status (Obj. F601h: 02h) Padding (1 bit) Padding (3 bit) Error (Obj. F601h: 04h) SS1 Status (Obj. F601h: 05h) SDIP Status (Obj. F601h: 07h) SDIN Status (Obj. F601h: 08h) SLS1 Status (Obj. F601h: 09h) SLS2 Status (Obj. F601h: 0Ah) SLS3 Status (Obj. F601h: 0Bh) SLS4 Status (Obj. F601h: 0Ch) FSoE Slave CRC_0 (Obj. E600h: 03h) SBC Status (Obj. F601h: 0Dh) SLT1 Status (Obj. F601h: 0Fh) SLT2 Status (Obj. F601h: 10h) SLT3 Status (Obj. F601h: 11h) SLT4 Status (Obj. F601h: 12h) Padding (10 bit) FSoE Slave CRC_1 (Obj. E600h: 04h) FSoE Slave ConnectionID (Obj. E600h: 02h)	This initial mapping is for an application in which the safety communication function is used. Map size: 11 bytes

4.4 Variable PDO mapping



PDO mappings can be changed in the Pre-Operational state.

The servo amplifier supports the variable PDO mapping function, which can arrange desired objects in any array for the data transmitted and received with RxPDO and TxPDO.

Variable PDO mapping specifications are shown in the following table.

Communication	Maximum number of objects	Maximum size [byte]	Number of mapping settings
RxPDO	32	64	4 (1600h to 1603h)
TxPDO			4 (1A00h to 1A03h)

PDO mapping objects are shown in the following table.

Index	Sub	Object	Name	Data Type	Access	Description
1600h	0	RECORD	1st Receive PDO Mapping	U8	rw	MR-JET-G-N1 User's Manual (Object Dictionary)
	1 to 32		Mapped Object 001 to Mapped Object 032	U32	rw	
1601h	0	RECORD	2nd Receive PDO Mapping	U8	rw	
	1 to 32		Mapped Object 001 to Mapped Object 032	U32	rw	
1602h	0	RECORD	3rd Receive PDO Mapping	U8	rw	
	1 to 32		Mapped Object 001 to Mapped Object 032	U32	rw	
1603h	0	RECORD	4th Receive PDO Mapping	U8	rw	
	1 to 32		Mapped Object 001 to Mapped Object 032	U32	rw	
1A00h	0	RECORD	1st Transmit PDO Mapping	U8	rw	
	1 to 32		Mapped Object 001 to Mapped Object 032	U32	rw	
1A01h	0	RECORD	2nd Transmit PDO Mapping	U8	rw	
	1 to 32		Mapped Object 001 to Mapped Object 032	U32	rw	
1A02h	0	RECORD	3rd Transmit PDO Mapping	U8	rw	
	1 to 32		Mapped Object 001 to Mapped Object 032	U32	rw	
1A03h	0	RECORD	4th Transmit PDO Mapping	U8	rw	
	1 to 32		Mapped Object 001 to Mapped Object 032	U32	rw	
1C12h	0	ARRAY	Sync Manager 2 PDO Assignment	U8	rw	
	1		PDO Mapping object index of assigned RxPDO	U16	rw	
	2					
	3					
1C13h	0	ARRAY	Sync Manager 3 PDO Assignment	U8	rw	
	1		PDO Mapping object index of assigned TxPDO	U16	rw	
	2					
	3					

When the safety communication function is used

Variable PDO mapping specifications are shown in the following table. The maximum number of RxPDO and TxPDO objects is the same as that when the safety communication function is not used. The safety RxPDO ([Obj. 1608h]) and safety TxPDO ([Obj. 1A08h]) are fixed values.

Communication	Number of objects	Maximum size [byte]	Number of mapping settings
Safety RxPDO	36	Refer to the following.	4 (1600h to 1603h)
Safety TxPDO			4 (1A00h to 1A03h)

The total bytes of objects that can be assigned to PDOs are limited depending on the communication cycle. The table below shows the relations between the communication cycles and PDO sizes. The total bytes of RxPDO and TxPDO are the same as those when the safety communication function is not used. The total bytes of safety RxPDO ([Obj. 1608h]) and safety TxPDO ([Obj. 1A08h]) are fixed values.

Communication cycle [ms]	RxPDO [byte]	TxPDO [byte]
0.25	11	11
0.5 to 8	11	11

PDO mapping objects are shown in the following table.

Index	Sub	Object	Name	Data Type	Access	Description
1608h	0	RECORD	9th Receive PDO Mapping	U8	ro	IMR-JET-G-N1 User's Manual (Object Dictionary)
	1 to 104		Mapped Object 001 to Mapped Object 104	U32	ro	
1A08h	0	RECORD	9th Transmit PDO Mapping	U8	ro	
	1 to 104		Mapped Object 001 to Mapped Object 104	U32	ro	
1C12h	0	ARRAY	Sync Manager 2 PDO Assignment	U8	rw	
	1		PDO Mapping object index of assigned RxPDO	U16	rw	
	2					
	3					
1C13h	0	ARRAY	Sync Manager 3 PDO Assignment	U8	rw	
	1		PDO Mapping object index of assigned TxPDO	U16	rw	
	2					
	3					

4.5 Objects that require mapping

Objects required for each mode are shown in the following table.

RxPDO

⊙: PDO mapping required ○: PDO mapping recommended —: PDO mapping not required

Object name (Index)	Mode								
	csp	csv	cst	pp *1	pv *1	tq *1	pt *2	kg *2	hm
Controlword (6040h)	⊙	⊙	⊙	⊙	⊙	⊙	⊙	⊙	⊙
Control DI 1 (2D01h) Gain switching	○	○	—	○	○	—	○	○	—
Control DI 2 (2D02h) Proportional control	○	—	—	○	—	—	○	○	○
Control DI 3 (2D03h)	○	○	○	○	○	○	○	○	○
Target position (607Ah)	⊙	—	—	⊙	—	—	—	—	—
Target velocity (60FFh)	—	⊙	—	—	⊙	—	—	—	—
Target torque (6071h)	—	—	⊙	—	—	⊙	—	—	—
Profile velocity (6081h) *1	—	—	—	○	—	—	—	○	—
Profile acceleration (6083h)	—	—	—	○	○	—	—	○	—
Profile deceleration (6084h)	—	—	—	○	○	—	—	○	—
Torque slope (6087h)	—	—	—	—	—	○	—	—	—
Velocity limit value (2D20h)	—	—	○	—	—	○	—	—	—
Target point table (2D60h) *2	—	—	—	—	—	—	⊙	—	—

*1 Available on servo amplifiers with firmware version B2 or later.

*2 Available on servo amplifiers with firmware version B8 or later.

TxPDO

⊙: PDO mapping required ○: PDO mapping recommended —: PDO mapping not required

Object name (Index)	Mode								
	csp	csv	cst	pp *1	pv *1	tq *1	pt *2	kg *2	hm
Statusword (6041h)	⊙	⊙	⊙	⊙	⊙	⊙	⊙	⊙	⊙
Status DO 1 (2D11h)	○	○	○	○	○	○	○	○	○
Status DO 2 (2D12h)	○	○	○	○	○	○	○	○	○
Status DO 3 (2D13h)	○	○	○	○	○	○	○	○	○
Status DO 5 (2D15h)	—	—	—	—	—	—	○	○	—
Status DO 7 (2D17h)	—	—	—	—	—	—	○	○	—
Position actual value (6064h)	○	○	○	○	○	○	○	○	○
Following error actual value (60F4h)	○	—	—	○	—	—	○	○	—
Velocity actual value (606Ch)	○	○	○	○	○	○	○	○	○
Torque actual value (6077h)	○	○	○	○	○	○	○	○	○
Point actual value (2D69h) *2	—	—	—	—	—	—	○	○	—
M code actual value (2D6Ah) *2	—	—	—	—	—	—	○	○	—
Point demand value (2D68h) *2	—	—	—	—	—	—	○	○	—

*1 Available on servo amplifiers with firmware version B2 or later.

*2 Available on servo amplifiers with firmware version B8 or later.

5 SDO (Service Data Object) COMMUNICATION

In SDO (Service Data Object) communication, object data can be transmitted and received asynchronously between a master station (controller) and a slave station (servo amplifier).

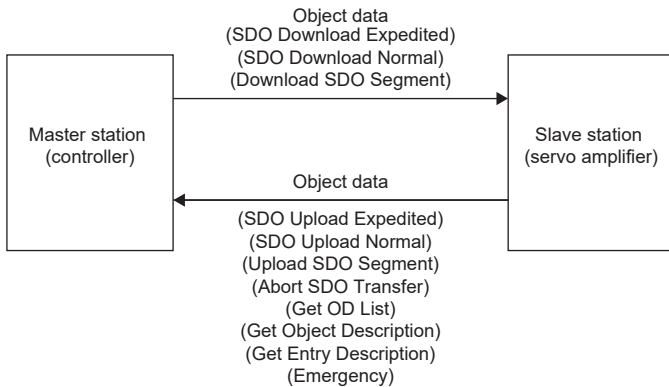

5.1 SDO communication-related services

The servo amplifier supports the following services related with SDO communication.

Services	Description
SDO Download Expedited	This service writes data of up to 4 bytes to the slave station.
SDO Download Normal	This service writes data of the specified bytes to the slave station.
Download SDO Segment	This service writes additional data when the object size is larger than the specified byte size.
SDO Upload Expedited	This service reads data of up to 4 bytes from the slave station.
SDO Upload Normal	This service reads data of the specified bytes from the slave station.
Upload SDO Segment	This service reads additional data when the object size is larger than the specified number of octets.
Abort SDO Transfer	This service notifies the SDO Abort Code when an error occurs in either of the services.
Get OD List	This service reads a list of available object indexes.
Get Object Description	This service reads the detail of indexes.
Get Entry Description	This service reads the detail of Sub indexes.
Emergency	This service notifies an alarm occurrence.

5.2 SDO Abort Code

When an error occurs in SDO communication, the Abort SDO Transfer service returns the following error messages.

SDO Abort Code	Meaning
0504 0005h	Out of memory.
0601 0001h	Attempt to read to a write only object
0601 0002h	Attempt to write to a read only object
0601 0006h	Object mapped to RxPDO, SDO download blocked.
0602 0000h	The object does not exist in the object dictionary
0604 0043h	General parameter incompatibility reason.
0607 0012h	Data type does not match, length of service parameter too high.
0607 0013h	Data type does not match, length of service parameter too short.
0609 0011h	Sub index does not exist
0609 0030h	Value range of parameter exceeded
0609 0031h	Value of parameter written too high
0609 0032h	Value of parameter written too low
0800 0000h	Generic error.
0800 0021h	Data cannot be transferred or stored to the application because of local control
0800 0022h	Data cannot be transferred or stored to the application because of the present device state.

6 SYNCHRONIZATION

6.1 Availability of synchronous mode in control mode

Availability of synchronous mode (DC mode) and asynchronous mode (Free-run mode) in each mode is shown in the following table.

Control mode	Synchronous mode	Asynchronous mode
Cyclic synchronous position mode (csp)	○	○ *1
Cyclic synchronous velocity mode (csv)	○	○ *1
Cyclic synchronous torque mode (cst)	○	○ *1
Profile position mode (pp) *2	○	○
Profile velocity mode (pv) *2	○	○
Profile torque mode (tq) *2	○	○
Point table mode (pt) *3	○	○
Jog mode (jg) *3	○	○
Homing mode (hm)	○	○

*1 For servo amplifiers with firmware versions earlier than B6, if a servo motor is driven with this combination, [AL. 09E.9 Control mode setting warning] will occur.

*2 Available on servo amplifiers with firmware version B2 or later.

*3 Available on servo amplifiers with firmware version B8 or later.

6.2 Synchronous mode (DC mode)

In the synchronous mode, the synchronous jitter needs to be kept less than 2 μs. If the synchronous jitter is 2 μs or more, an error may be detected and an alarm may occur.

—	Sync0	Sync1
[Cycle Time (Obj. 1C32h: 02h)] *1	0.125 ms (when the PDO communication cycle is set to 0.125 ms) 0.25 ms (when the PDO communication cycle is set to 0.25 ms) 0.5 ms (when the PDO communication cycle is set to 0.5 ms) 1 ms (when the PDO communication cycle is set to 1 ms) 2 ms (when the PDO communication cycle is set to 2 ms) 4 ms (when the PDO communication cycle is set to 4 ms) 8 ms (when the PDO communication cycle is set to 8 ms)	Unused

*1 There are restrictions on the communication cycle depending on the function used. For details, refer to "Restrictions on the MR-JET-_G_" in the following manual.

MR-JET-G-N1 User's Manual (Introduction)

6.3 Asynchronous mode (Free-run mode)

When using the cyclic synchronous position mode, cyclic synchronous velocity mode, or cyclic synchronous torque mode in the asynchronous mode (Free-run mode), set them as shown in the table in this section. Enter a command value for each communication cycle set in [Cycle Time (Obj. 1C32h: 02h)]. If the command values are not entered for the communication cycles, the previously entered commands are maintained. Setting this object is not required when using the profile position mode, profile velocity mode, or profile torque mode. Operation can be performed in any communication cycle.

—	Local Cycle time
[Cycle Time (Obj. 1C32h: 02h)] *1*2	0.125 ms (when the PDO communication cycle is set to 0.125 ms) 0.25 ms (when the PDO communication cycle is set to 0.25 ms) 0.5 ms (when the PDO communication cycle is set to 0.5 ms) 1 ms (when the PDO communication cycle is set to 1 ms) 2 ms (when the PDO communication cycle is set to 2 ms) 4 ms (when the PDO communication cycle is set to 4 ms) 8 ms (when the PDO communication cycle is set to 8 ms)

*1 When no value is set in Cycle time, the communication cycle is 0.25 ms (initial value). The initial value can be changed with [Pr. PN07 Communication cycle setting]. [Pr. PN07 Communication cycle setting] can be used on servo amplifiers with firmware version B6 or later.

*2 There are restrictions on the communication cycle depending on the function used. For details, refer to "Restrictions on the MR-JET-_G_" in the following manual.

 MR-JET-G-N1 User's Manual (Introduction)

7 CiA 402 DRIVE PROFILE

7.1 PDS state transitions

The internal state of the servo amplifier is managed by the PDS state defined in the CiA 402 drive profile specification. After the PDO communication is established (after the AL state has reached "Operational"), the status is controlled by the master station transmitting commands (by setting Controlword) in accordance with the following table. Once the state transitions from "Not ready to switch on", which is right after turning on the power supply, to "Operation enabled", the servo motor becomes ready to operate.

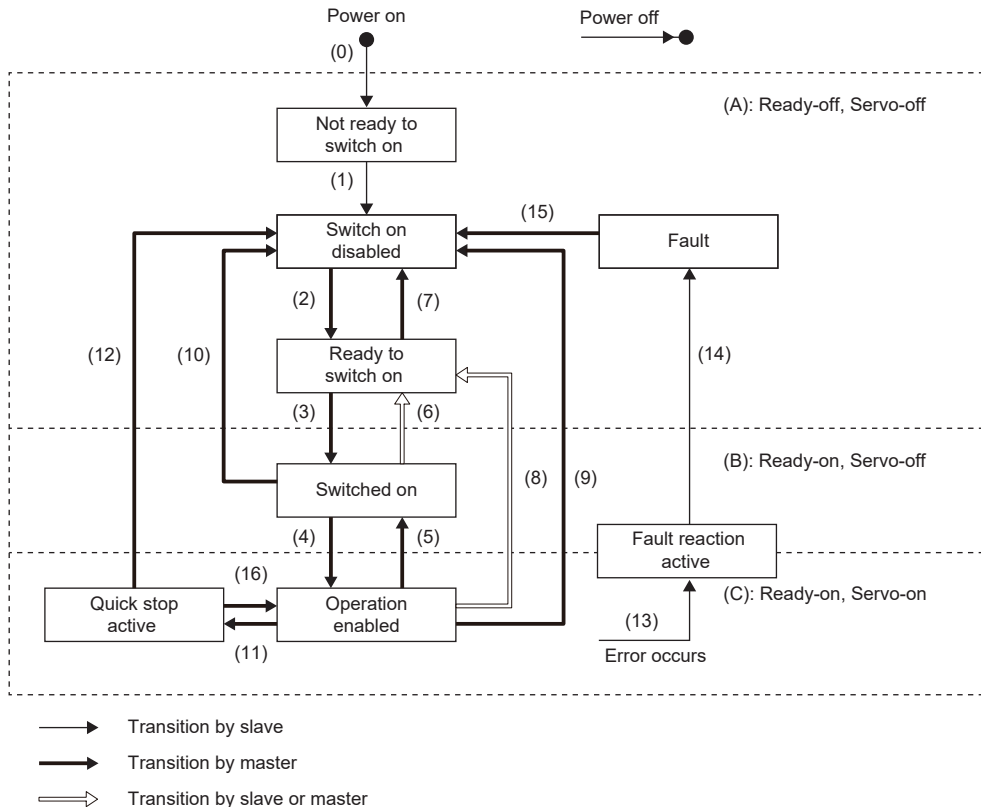

Transition No.	Event	Description
(0)	Power supply is turned on	Initialization
(1)	Transitions automatically when the power supply is turned on	Communication setting
(2)	Transitions with the "Shutdown" command from the master station	—
(3)	Transitions with the "Switch On" command from the master station	The dynamic brake is released.
(4)	Transitions with the "Enable Operation" command from the master station	The operation becomes ready after servo-on.
(5)	Transitions with the "Disable Operation" command from the master station Transitions when RD (Ready) is turned off	The operation is disabled after servo-off.
(6)	Transitions with the "Shutdown" command from the master station	The dynamic brake operates.
(7)	Transitions with the "Disable Voltage" command or "Quick Stop" command from the master station	—
(8)	(A) Transitions with the "Shutdown" command from the master station (B) Transitions when the power supply is turned off (C) Transitions in the servo-off state (see the transition No. (5) if RD is turned off at the same time)	The operation is disabled after servo-off and dynamic braking.
(9)	Transitions with the "Disable Voltage" command from the master station	The operation is disabled after servo-off and dynamic braking.
(10)	Transitions with the "Disable Voltage" command or "Quick Stop" command from the master station	The dynamic brake operates.
(11)	(A) Transitions with the "Quick Stop" command from the master station (B) Transitions when the forced stop signal is turned off *1	Quick Stop starts.

Transition No.	Event	Description
(12) *2	(A) Transitions automatically after the completion of Quick Stop (when the value of [Quick stop option code (Obj. 605Ah)] is any of "1", "2", "3", or "4") (B) Transitions with the "Disable Voltage" command from the master station after completion of "Quick Stop" (C) Transitions when the power supply is turned off (when the value of [Quick stop option code (Obj. 605Ah)] is any of "5", "6", "7", or "8")	The operation is disabled after servo-off and dynamic braking.
(13)	Alarm occurrence	The processing for the alarm occurrence is executed.
(14)	Automatic transition	After the completion of the alarm occurrence processing, the operation is disabled by servo-off or the dynamic brake.
(15)	Transitions with the "Fault Reset" command from the master station	An alarm reset is performed. Resettable alarms are reset.
(16) *3	Transitions with the "Enable Operation" command from the master station (when the value of [Quick stop option code (Obj. 605Ah)] is any of "5", "6", "7", or "8")	The operation becomes ready.

*1 This event occurs when "1" (Quick stop active) is selected in [Pr. PF29.1 State selection with forced stop in progress].

*2 (C) is available on servo amplifiers with firmware version D0 or later.

*3 Available on servo amplifiers with firmware version D0 or later.

The commands issued to the servo amplifier are shown in the table below. Turn on the Bits relative to the command.

0: Off 1: On —: Either on/off can be used

Command	Command Bit setting of Controlword					Transition No.
	Bit 7 Fault Reset	Bit 3 Enable Operation	Bit 2 Quick Stop	Bit 1 Enable Voltage	Bit 0 Switch On	
Shutdown	0	—	1	1	0	(2), (6), (8)
Switch On	0	0	1	1	1	(3)
Disable Voltage	0	—	—	0	—	(7), (9), (10), (12)
Quick Stop	0	—	0	1	—	(7), (10), (11)
Disable Operation	0	0	1	1	1	(5)
Enable Operation	0	1	1	1	1	(4), (16)
Fault Reset	0 → 1 *1	—	—	—	—	(15)

*1 In order to avoid missing the command at the time of a communication error, maintain the state of Bit 7 = 1 on the Fault Reset command for at least 10 ms when the communication cycle is 4 ms or less, or at least 20 ms when the communication cycle is 8 ms or less.

In order to transition from the "Switch on disabled" state to the "Operation enabled" state, give the commands "Shutdown", "Switch On", and "Enable Operation" sequentially. If using an MR-JET servo amplifier, however, it is possible to transition directly from the current state to the target state with one command.





Current state	Command	State after transition
Switch on disabled	Switch On	Switched on
Switch on disabled	Enable Operation	Operation enabled
Ready to switch on	Enable Operation	Operation enabled

7.2 Controlword/Control DI

The PDS states can be switched and control instructions for various driving-related functions can be given by rewriting the Controlword and Control DI x objects from the master station. [Obj. 6040h] is used for the control commands defined by CiA 402, and [Obj. 2D01h] and other objects are used for other control commands defined by Mitsubishi Electric.

Index	Sub	Object	Name	Data Type	Access	Description
6040h	—	VAR	Controlword	U16	rw	—
2D01h	—	VAR	Control DI 1	U16	rw	Objects defined by Mitsubishi Electric
2D02h	—	VAR	Control DI 2	U16	rw	Objects defined by Mitsubishi Electric
:	:	:	:	:	:	:

Bit definition of Controlword

Bit	Symbol	Description
0	SO	Switch On
1	EV	Enable Voltage
2	QS	Quick Stop
3	EO	Enable Operation
4	OMS	The contents differ depending on the setting of [Modes of operation (Obj. 6060h)]. Refer to "Control mode" in the following manual.  MR-JET User's Manual (Function)
5		
6		
7	FR	Fault Reset
8	HALT	0: Operation ready 1: Temporary stop
9	OMS	The contents differ depending on the setting of [Modes of operation]. Refer to "Control mode" in the following manual.  MR-JET User's Manual (Function)
10	—	The value at reading is undefined. Set "0" when writing.
11	CPTL	Positive Torque Limit switching  Page 51 Torque limit selection
12	CNTL	Negative Torque Limit switching  Page 51 Torque limit selection
13	—	The value at reading is undefined. Set "0" when writing.
14		
15		

Bit definition of Control DI

With the communication function, reading the following objects enables reading of the on/off state of the input device. In addition, the input device can be set to on/off by writing to the following objects.

- Control DI 1

Bit	Symbol	Description	Reference
0	—	The value at reading is undefined. Set "0" when writing.	—
1	—		—
2	—		—
3	—		—
4	C_CDP	Gain switching	Refer to "Signal (device) explanations" in the following manual.  IMR-JET User's Manual (Hardware)
5	C_CLD *1	Fully closed loop selection	
6	—	The value at reading is undefined. Set "0" when writing.	—
7	—		—
8	—		—
9	—		—
10	—		—
11	—		—
12	—		—
13	—		—
14	—		—
15	—		—

*1 Available on servo amplifiers with firmware version C4 or later.

- Control DI 2

Bit	Symbol	Description	Reference
0	—	The value at reading is undefined. Set "0" when writing.	—
1	—		—
2	—		—
3	—		—
4	—		—
5	—		—
6	—		—
7	—		—
8	C_PC	Proportional control	Refer to "Signal (device) explanation" in the following manual.  IMR-JET User's Manual (Hardware)
9	—	The value at reading is undefined. Set "0" when writing.	
10	—		—
11	—		—
12	—		—
13	—		—
14	—		—
15	C_ORST *1		Operation alarm reset

*1 Available on servo amplifiers with firmware version B2 or later.

• Control DI 3

Bit	Symbol	Description	Reference
0	—	The value at reading is undefined. Set "0" when writing.	—
1	—		—
2	—		—
3	—		—
4	—		—
5	—		—
6	—		—
7	—		—
8	—		—
9	—		—
10	—		—
11	—		—
12	—		—
13	—		—
14	—		—
15	—		—

• Control DI 4

Bit	Symbol	Description	Reference
0	—	The value at reading is undefined. Set "0" when writing.	—
1	—		—
2	—		—
3	—		—
4	—		—
5	—		—
6	—		—
7	—		—
8	—		—
9	—		—
10	—		—
11	—		—
12	—		—
13	—		—
14	—		—
15	—		—

• Control DI 5

Bit	Symbol	Description	Reference
0	—	The value at reading is undefined. Set "0" when writing.	—
1	—		—
2	—		—
3	—		—
4	C_CDP2	Gain switching 2	Refer to "Signal (device) explanation" in the following manual.  MR-JET User's Manual (Hardware)
5	—	The value at reading is undefined. Set "0" when writing.	—
6	—		—
7	—		—
8	—		—
9	—		—
10	—		—
11	—		—
12	—		—
13	—		—
14	—		—
15	—		—

• Control DI 6

Bit	Symbol	Description	Reference
0	—	The value at reading is undefined. Set "0" when writing.	—
1	—		—
2	—		—
3	—		—
4	—		—
5	—		—
6	—		—
7	—		—
8	—		—
9	—		—
10	—		—
11	—		—
12	—		—
13	—		—
14	—		—
15	—		—

• Control DI 7

Bit	Symbol	Description	Reference
0	—	The value at reading is undefined. Set "0" when writing.	—
1	—		—
2	—		—
3	—		—
4	—		—
5	—		—
6	—		—
7	C_OVR*1	Override selection	Refer to "Override function" in the following manual.  MR-JET User's Manual (Function)
8	—	The value at reading is undefined. Set "0" when writing.	—
9	—		—
10	—		—
11	—		—
12	—		—
13	—		—
14	—		—
15	—		—

*1 Available on servo amplifiers with firmware version D4 or later.

• Control DI 8

Bit	Symbol	Description	Reference
0	—	The value at reading is undefined. Set "0" when writing.	—
1	—		—
2	—		—
3	—		—
4	—		—
5	—		—
6	—		—
7	—		—
8	—		—
9	—		—
10	—		—
11	—		—
12	—		—
13	—		—
14	—		—
15	—		—

• Control DI 9

Bit	Symbol	Description	Reference
0	—	The value at reading is undefined. Set "0" when writing.	—
1	—		—
2	—		—
3	—		—
4	—		—
5	—		—
6	—		—
7	—		—
8	—		—
9	—		—
10	—		—
11	—		—
12	—		—
13	—		—
14	—		—
15	—		—

• Control DI 10

Bit	Symbol	Description	Reference
0	—	The value at reading is undefined. Set "0" when writing.	—
1	—		—
2	—		—
3	—		—
4	—		—
5	—		—
6	—		—
7	—		—
8	—		—
9	—		—
10	—		—
11	—		—
12	—		—
13	—		—
14	—		—
15	—		—

7.3 Statusword/Status DO

The Statusword objects and the Status DO x objects notify the master station of the PDS state and other drive states. States defined by CiA 402 are notified by using [Obj. 6041h], and states defined by Mitsubishi Electric are notified by using [Obj. 2D11h].

Index	Sub	Object	Name	Data Type	Access	Description
6041h	—	VAR	Statusword	U16	ro	—
2D11h	—	VAR	Status DO 1	U16	ro	Objects defined by Mitsubishi Electric
2D02h	—	VAR	Status DO 2	U16	ro	Objects defined by Mitsubishi Electric
:	:	:	:	:	:	:

Bit definition of Statusword

Bit	Symbol	Description
0	RTSO	Ready-to-switch-on
1	SO	Switch-on
2	OE	Operation-enabled
3	F	Fault
4	VE	Voltage-enabled 0: The bus voltage is lower than the specified (RA) level. 1: The bus voltage is equal to or higher than the specified level.
5	QS	Quick stop 0: In a Quick stop 1: Not in a Quick stop (including in the test mode)
6	SOD	Switch on disabled
7	W	Warning 0: No warning has occurred. 1: A warning has occurred.
8	—	The value at reading is undefined.
9	RM	Remote 0: Not following the Controlword command. 1: Operating in accordance with the Controlword command.
10	OMS	Operation Mode Specific The contents differ depending on the setting of [Modes of operation (Obj. 6060h)]. Refer to "Control mode" in the following manual. IMR-JET User's Manual (Function)
11	ILA	Internal limit active 0: The forward rotation stroke end, reverse rotation stroke end, and software position limit have not been reached. 1: The forward rotation stroke end, reverse rotation stroke end, or software position limit has been reached. (Enabled in csp, csv, pp, pv, hm, pt, or jg mode)
12	OMS	Operation Mode Specific The contents differ depending on the setting of [Modes of operation (Obj. 6060h)]. Refer to "Control mode" in the following manual. IMR-JET User's Manual (Function)
13		
14	—	The value at reading is undefined.
15		

Bit 0 to Bit 3, Bit 5, and Bit 6 are switched depending on the PDS state (servo amplifier internal state). Refer to the following table for details.

Statusword (bin)	PDS state
x0xx xxx0 x0xx 0000	Not ready to switch on *1
x0xx xxx0 x1xx 0000	Switch on disabled
x0xx xxx0 x01x 0001	Ready to switch on
x0xx xxx0 x01x 0011	Switched on
x0xx xxx0 x01x 0111	Operation enabled
x0xx xxx0 x00x 0111	Quick stop active
x0xx xxx0 x0xx 1111	Fault reaction active
x0xx xxx0 x0xx 1000	Fault

*1 Statusword is not sent when in the "Not ready to switch on" state.

Bit definition of Status DO

With the communication function, the on/off state of the output device can be checked by reading the following objects.

- Status DO 1

Bit	Symbol	Description	Reference
0	—	The value at reading is undefined.	—
1	—		—
2	S_SA	Speed reached	Refer to "Signal (device) explanations" in the following manual.
3	S_MBR	Electromagnetic brake interlock	
4	S_CDPS	Variable gain enabled	MR-JET User's Manual (Hardware)
5	S_CLDS *1	Fully closed loop control in progress	
6	—	The value at reading is undefined.	—
7	—		—
8	—		—
9	—		—
10	—		—
11	—		—
12	S_INP	In-position	Refer to "Signal (device) explanations" in the following manual.
13	S_TLC	Limiting torque	
14	S_ABSV	Absolute position erased	MR-JET User's Manual (Hardware)
15	S_BWNG	Battery warning	

*1 Available on servo amplifiers with firmware version C4 or later.

- Status DO 2

Bit	Symbol	Description	Reference
0	S_ZPASS	Z-phase already passed After the Z-phase is passed, S_ZPASS turns on.	—
1	—	The value at reading is undefined.	—
2	—		—
3	S_ZSP	Zero speed detection	Refer to "Signal (device) explanation" in the following manual. MR-JET User's Manual (Hardware)
4	S_VLC	Limiting speed	
5	—	The value at reading is undefined.	—
6	S_IPF	In IPF During instantaneous power failure, S_IPF is on.	—
7	—	The value at reading is undefined.	—
8	S_PC	Proportional control in progress S_PC is turned on under proportional control.	—
9	—	The value at reading is undefined.	—
10	S_DB	External dynamic brake output	—
11	—	The value at reading is undefined.	—
12	—		—
13	—		—
14	—		—
15	S_ZP2	Homing completion 2 When homing finishes successfully, S_ZP2 turns on.	—

• Status DO 3

Bit	Symbol	Description	Reference
0	—	The value at reading is undefined.	—
1	—		—
2	—		—
3	—		—
4	—		—
5	S_STO *1	In STO state S_STO turns on in STO state.	Refer to "Monitor signal (digital)" in the following manual. MR-JET User's Manual (Function)
6	—	The value at reading is undefined.	—
7	—		—
8	—		—
9	—		—
10	—		—
11	S_MTTR	Tough drive in progress	Refer to "Tough drive function" in the following manual. MR-JET User's Manual (Function)
12	—	The value at reading is undefined.	—
13	—		—
14	—		—
15	—		—

*1 This function is available only on the MR-JET-G-HSN1.

• Status DO 4

Bit	Symbol	Description	Reference
0	—	The value at reading is undefined.	—
1	—		—
2	—		—
3	—		—
4	—		—
5	—		—
6	—		—
7	—		—
8	—		—
9	—		—
10	—		—
11	—		—
12	—		—
13	—		—
14	—		—
15	—		—

• Status DO 5

Bit	Symbol	Description	Reference
0	—	The value at reading is undefined.	—
1	—		—
2	—		—
3	—		—
4	S_CDPS2	Variable gain enabled 2	Refer to "GAIN SWITCHING FUNCTION" in the following manual. MR-JET User's Manual (Adjustment)
5	S_CPO *2	Rough match When the command remaining distance is less than the value of the rough match output range set in [Pr. PT12], S_CPO is on.	—
6	S_MEND *3	Traveling completion If droop pulses are within the in-position output range set in [Pr. PA10] and the command remaining distance is "0", S_MEND turns on. S_MEND turns on at servo-on. S_MEND is off in the servo-off status.	—
7	—	The value at reading is undefined.	—
8	—		—
9	—		—
10	—		—
11	—		—
12	—		—
13	—		—
14	—		—
15	—		—

*2 Available on servo amplifiers with firmware version B2 or later.

*3 Available on servo amplifiers with firmware version B8 or later.

• Status DO 6

Bit	Symbol	Description	Reference
0	—	The value at reading is undefined.	—
1	—		—
2	—		—
3	—		—
4	—		—
5	—		—
6	—		—
7	—		—
8	—		—
9	—		—
10	—		—
11	—		—
12	—		—
13	—		—
14	—		—
15	—		—

• Status DO 7

Bit	Symbol	Description	Reference
0	—	The value at reading is undefined.	—
1	—		—
2	S_POT *1	Position range When the actual current position is within the range set in [Pr. PT19] and [Pr. PT21], S_POT is on. When homing is not complete or base circuit shut-off is in progress, S_POT is off.	—
3	—	The value at reading is undefined.	—
4	—		—
5	—		—
6	—		—
7	—		—
8	—		—
9	—		—
10	—		—
11	—		—
12	—		—
13	—		—
14	—		—
15	—		—

*1 Available on servo amplifiers with firmware version B2 or later.

• Status DO 8

Bit	Symbol	Description	Reference
0	—	The value at reading is undefined.	—
1	—		—
2	—		—
3	—		—
4	—		—
5	—		—
6	—		—
7	—		—
8	—		—
9	—		—
10	—		—
11	—		—
12	—		—
13	—		—
14	—		—
15	—		—

• Status DO 9

Bit	Symbol	Description	Reference
0	—	The value at reading is undefined.	—
1	—		—
2	—		—
3	—		—
4	—		—
5	—		—
6	—		—
7	—		—
8	—		—
9	—		—
10	—		—
11	—		—
12	—		—
13	—		—
14	—		—
15	—		—

• Status DO 10

Bit	Symbol	Description	Reference
0	—	The value at reading is undefined.	—
1	—		—
2	—		—
3	—		—
4	—		—
5	—		—
6	—		—
7	—		—
8	—		—
9	—		—
10	—		—
11	—		—
12	—		—
13	—		—
14	—		—
15	—		—

7.4 Control mode

Point

- The control mode is set to the cyclic synchronous position mode as a default. When using the cyclic synchronous position mode, perform alignment with the upper controller at servo-on.
- When using the profile mode, switch to the mode in the servo-off state. After the control mode is switched, turn on the servo-on.
- Switching the control mode without performing alignment may cause unexpected operation of the servo motor such as quick acceleration.

Selecting control mode (Modes of operation)

Specify a control mode with [Modes of operation (Obj. 6060h)]. [Modes of operation] can be rewritten with a PDO or an SDO. The available control modes are limited as follows depending on the setting value of [Pr. PT01.2].

○: Supported, —: Not supported

[Pr. PA01.0]	[Pr. PT01.2]	pp	pv	tq	hm	csp	csv	cst	fg ^{*1}	pt ^{*1}	6061h initial value
0	0 (mm) ^{*3}	—	—	—	—	—	—	—	—	—	8 (csp)
	1 (inch) ^{*3}	—	—	—	—	—	—	—	—	—	
	2 (degree) ^{*2}	○	○	○	○	—	—	—	—	—	1 (pp)
	3 (pulse)	○	○	○	○	○	○	○	—	—	8 (csp)
6	0 (mm)	—	—	—	○	—	—	—	○	○	-101 (pt)
	1 (inch)	—	—	—	—	—	—	—	—	—	
	2 (degree)	—	—	—	—	—	—	—	—	—	
	3 (pulse)	—	—	—	—	—	—	—	—	—	

*1 Available on servo amplifiers with firmware version B8 or later.

*2 Available on servo amplifiers with firmware version B6 or later.

*3 Setting [Pr. PT01.2] to "0" or "1" triggers [AL. 037 Parameter error].

Index	Sub	Object	Name	Data Type	Access	Description
6060h	—	VAR	Modes of operation	I8	rw	0: No mode change/No mode assigned 1: Profile position mode (pp) ^{*1} 3: Profile velocity mode (pv) ^{*1} 4: Profile torque mode (tq) ^{*1} 6: Homing mode (hm) 8: Cyclic sync position mode (csp) 9: Cyclic sync velocity mode (csv) 10: Cyclic sync torque mode (cst) -100: Jog mode (fg) ^{*2} -101: Point table Mode (pt) ^{*2}
6061h	—	VAR	Modes of operation display	I8	ro	0: No mode assigned 1: Profile position mode (pp) ^{*1} 3: Profile velocity mode (pv) ^{*1} 4: Profile torque mode (tq) ^{*1} 6: Homing mode (hm) 8: Cyclic sync position mode (csp) 9: Cyclic sync velocity mode (csv) 10: Cyclic sync torque mode (cst) -100: Jog mode (fg) ^{*2} -101: Point table Mode (pt) ^{*2}
6502h	—	VAR	Supported drive modes	U32	ro	Bit =1 for the following modes bit 0: Profile position mode ^{*1} bit 2: Profile velocity mode ^{*1} bit 3: Profile torque mode ^{*1} bit 5: Homing mode bit 7: Cyclic sync position mode bit 8: Cyclic sync velocity mode bit 9: Cyclic sync torque mode bit 16: Jog mode (fg) ^{*2} bit 17: Point table Mode (pt) ^{*2}

*1 Available on servo amplifiers with firmware version B2 or later.

*2 Available on servo amplifiers with firmware version B8 or later.

Control switching

Point

- Changes to the OMS Bit of [Controlword (Obj. 6040h)] are not accepted until control switching finishes. Before inputting commands, check that the control mode has been switched by referring to [Modes of operation display (Obj. 6061h)]. In addition, switch the control modes when the start command is turned off. (For example, when "Homing operation start" is turned off in hm mode.)
 - Update [Target position (Obj. 607Ah)] and [Position offset (Obj. 60B0h)] to [Position actual value (Obj. 6064h)] when changing the control mode from the mode other than the cyclic synchronous position mode (csp) to the cyclic synchronous position mode (csp).
-

Control switching between position/speed/torque modes

As there is a time lag when switching between control modes, the controller needs to keep sending the command values of the corresponding control modes until the mode is completely switched. After the completion of the control mode switching is confirmed by [Modes of operation display], the controller can stop sending the command value relative to the control mode before switching.

Before switching to or from the position mode, check that the servo motor is in zero speed state. Data of whether the servo motor is in zero speed state can be obtained by Bit 3 (S_ZSP) of [Status DO 2 (Obj. 2D12h)]. If the motor is not in zero speed state, the control mode will not be switched and therefore [Modes of operation display (Obj. 6061h)] will not change. To switch the control mode regardless of the zero speed state, set [Pr. PC76.1 ZSP disabled selection at control switching] to "1" to disable the monitoring of zero speed state. When the monitoring of zero speed state is disabled, a shock may occur at control switching.

Control switching between cyclic mode (csp, csv, and cst) and profile mode (pp, pv, and tq)

The control mode is switched between the cyclic mode (csp, csv, and cst) and the profile mode (pp, pv, and tq) only if the condition for control switching is met, following which [Modes of operation display (Obj. 6061h)] is changed. If the condition for control switching is not met, the control mode will not be switched and the value in [Modes of operation display (Obj. 6061h)] will not be changed. The condition for control switching is "Motor being stopped".

"Motor being stopped" means that S_ZSP (Bit 3 of [Status DO 2 (Obj. 2D12h)]) is on.

(Servo motor speed being less than zero speed set in [Pr. PC07])

Setting "1" (disabled (control switching is performed regardless of the range of ZSP)) to [Pr. PC76.1] enables the control mode to be switched without checking the condition "Motor being stopped" on the servo amplifier. Set "1" to [Pr. PC76.1] only if switching the control mode without waiting for the motor to stop. Switching the control mode without waiting for the motor to stop may cause a shock.

The following shows a timing chart of control switching between the cyclic mode (csp, csv, and cst) and the profile mode (pp, pv, and tq).

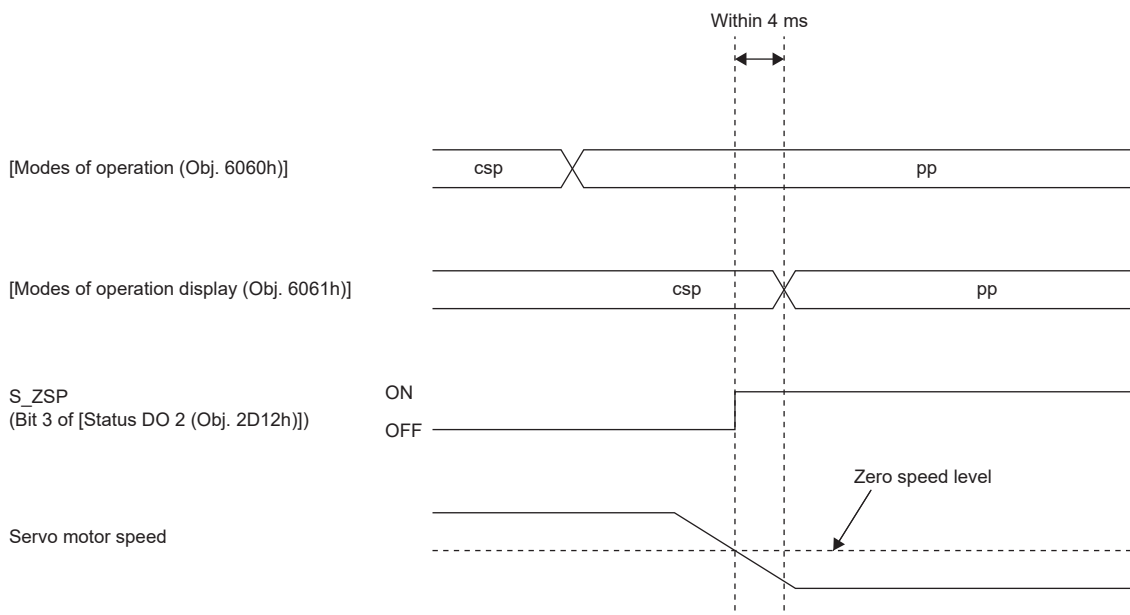

Control switching in positioning mode

Refer to "Control switching in positioning mode" in the following manual.

MR-JET User's Manual (Function)

8 STARTUP

For the startup procedures other than the network settings, refer to the following user's manual.

📖 MR-JET-G-N1 User's Manual (Introduction)

Precautions

To ensure the safety of the system against unauthorized network access, take security measures such as using a firewall.

Point

For servo amplifiers with firmware version D4 or later, the PDO Mapping attribute of the objects has been changed. To use the PDO Mapping attribute before the change, set "1" in [Pr. PN03.3 Object attribute selection]. For details, refer to "[Pr. PN03.3 Object attribute selection]" in the following manual.

📖 MR-JET-G-N1 User's Manual (Introduction)

When setting "1" in [Pr. PN03.3], contact the sales representative for available ESI files.

The servo amplifiers with firmware version E8 or later support ESI files in both Device format and Module format. When using the safety communication function, use ESI files in Module format. If the controller being used cannot read ESI files that support the Module format, use ESI files created only in the conventional Device format. However, the safety communication function cannot be used with ESI files created only in Device format.

8.1 Absolute position detection system configuration

Outline

Controllers not using homing mode with the servo amplifier manage the home position via the controller, so setting of a home position is not performed for the servo amplifier. Refer to this section for information about how to configure the absolute position detection system for controllers not using homing mode with the servo amplifier.

When using homing mode with the servo amplifier, refer to "CONTROL MODE" in the following manual.

📖 MR-JET User's Manual (Function)

Precautions and restrictions

- [Pr. PC41.0 [AL. 090.1 Homing incomplete] detection selection] can only be used in cyclic synchronous position mode (csp).
- Setting of a home position is not performed for the servo amplifier, so the software limit function ([Software position limit (Obj. 607Dh)]) cannot be used.
- When [AL. 025 Absolute position erased] occurs, perform homing again via the controller to prevent an unexpected operation.
- Do not rotate the servo motor in excess of 2147483647 pulses without an EtherCAT communication established. Doing so causes the controller to be unable to correctly restore to the current position when the EtherCAT communication is established.
- Once the relevant settings for the absolute position detection system have been performed, the absolute position cannot be managed with the servo amplifier. To prevent unexpected operation, perform management of the absolute position via the controller.

Startup procedure

Battery installation

If using a servo motor that requires installation of a battery in order to configure the absolute position detection system, install the battery as necessary.

Parameter setting

■Absolute position detection system selection

To enable the absolute position detection system, set [Pr. PA03.0] to "1" (enabled (absolute position detection system)).

■[AL. 0E3 Absolute position counter warning] selection

If the travel distance from the home position is 32768 rev or more, [AL. 0E3.1] occurs.

To disable [AL. 0E3], set [Pr. PC29.5 [AL. 0E3 Absolute position counter warning] selection] to "0" (disabled).

■[AL. 090.1 Homing incomplete] detection selection

[AL. 090.1] occurs at servo-on if a home position has not been set for the servo amplifier.

To disable [AL. 090.1], set [Pr. PC41.0 [AL. 090.1 Homing incomplete] detection selection] to "1" (disabled).

[AL. 025.1 Servo motor encoder absolute position erased] deactivation

[AL. 025.1 Servo motor encoder absolute position erased] occurs when performing initial settings for the absolute position detection system.

Wait for 5 seconds, then cycle the power to deactivate the alarm.

Homing

Be sure to perform homing before performing positioning operation.

8.2 Connecting Ethernet cables

Point

- Use a twisted pair cable (double shielded) compliant with Ethernet Category 5e (100BASE-TX) or higher as an Ethernet cable. The maximum cable length between nodes is 100 m.
- When connecting Ethernet cables to servo amplifiers, be aware that CN1A is the IN port and CN1B is the OUT port.

Connect the Ethernet cable connected to the controller or the preceding servo amplifier to CN1A (IN port). Connect the Ethernet cable connected with the succeeding servo amplifier to CN1B (OUT port). Leave CN1B (OUT port) open if not using it.

When the node address is not used, an incorrect connection destination sets node addresses that do not correspond to the actual connection order and may cause a malfunction, such as an operation of an unintended axis.

The following figure shows a connection example viewed from the top surface of the servo amplifiers.

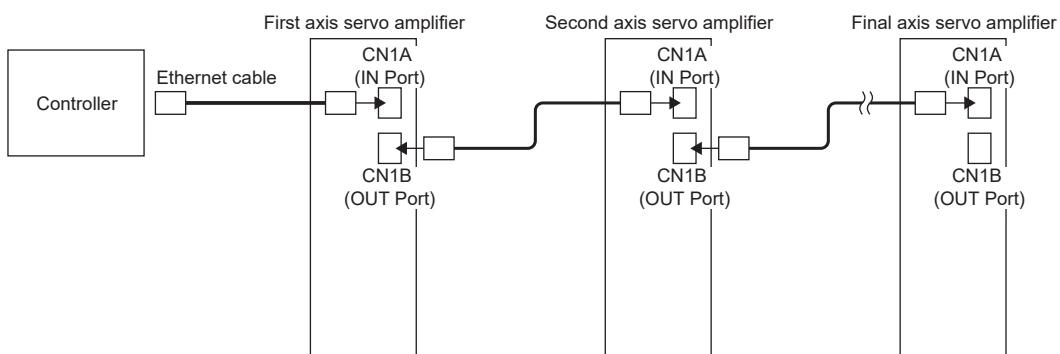

8.3 Example set-up procedure

Set up the controller by following its manual. An example set-up procedure is shown below.

Controller settings

ESI file installation

Point 

Use the latest ESI file when setting up a controller. If the ESI file is old, newly added objects may not be usable. For the ESI files usable with your servo amplifier, contact your local sales office.

Store the EtherCAT Slave Information (ESI) file, which lists information about the communication settings of devices, on the controller. The controller configures settings of connected slave stations in accordance with their ESI files.

In addition, the ENI file is generated from the online information that is read from the object dictionary or the EEPROM in the slave station (or both). For details, refer to the manual for the controller being used.

Node address setting

Point 

The node address of a servo amplifier is set according to Explicit Device Identification. Configure the settings complied with Explicit Device Identification to the controller.

Do not connect several devices which have the same node address setting.

Set a node address in EtherCAT as necessary with ID setting switches (SW1/SW2) on the display, [Pr. NPA09 Node address setting], or with SII Configured Station Alias. After the node address settings are changed, cycle the power.

Identifying slave stations with node addresses

The controller can identify slave stations by the node address using AL Status Code (ESC register: 0134h) or Configured Station Alias (ESC register: 0012h). Identify the slave stations by using either code.

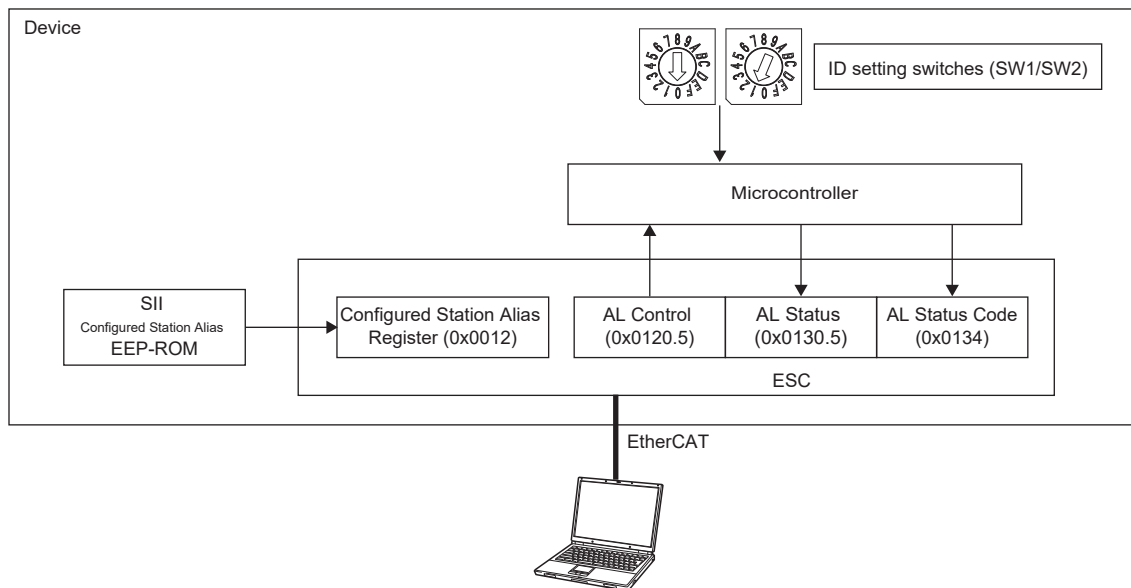

- Identifying with AL Status Code (ESC register: 0134h)

Set the node address with the ID setting switches (SW1/SW2) or [Pr. NPA09] by referring to the following table. Set the master station using AL Status Code (ESC register: 0134h) so that the node address is recognized.

When using [Pr. NPA09] for the node address, set the ID setting switches (SW1/SW2) to "00h".

When using the ID setting switches (SW1/SW2) for the node address, the value set in [Pr. NPA09] is not reflected in the node address.

ID setting switches (SW1/SW2)	[Pr. NPA09]	Node address
00h	00000000h to 0000FFFFh	The setting value of [Pr. NPA09] is the node address.
01h to FFh	—	The node address comprises of the setting values of ID setting switches (SW1/SW2).

- Identifying with Configured Station Alias (ESC register: 0012h)

Write the value of the node address to SII Configured Station Alias (ESC register: 0012h) from the master station (controller). The node address is saved on EEPROM. Set the master station so that SII Configured Station Alias (ESC register: 0012h) is recognized as a node address.

Mapping settings

When mapping objects that transmit command data and feedback data using PDO communication, perform the settings via the controller.

For information regarding the default mappings of the servo amplifier, refer to the following section.

☞ Page 17 PDO default mapping

Communication setting

For settings related to communication between the controller and servo amplifier, perform the settings via the controller. For information regarding settable communication cycles, refer to the following section.

☞ Page 10 Communication specifications

For the servo amplifier, synchronous mode (DC mode) and asynchronous mode (FreeRun mode) can be set. Set the mode that is appropriate for the application.

Establishing the communication

Start communication with the controller, then confirm that "r" appears on the 7-segment LED display.

Follow the manual for the controller being used when starting communication.

If [AL. 086.1 Network receive data error (Network communication error 1)] occurs, set a threshold in [Pr. PN18 Counter level for communication error detection] or [Sync Error Counter Limit (Obj. 10F1h: 02h)] that is appropriate for the controller being used.

Operating the servo motor

An example procedure for operating in cyclic synchronous position mode (csp) is shown below.

Homing mode settings

To operate in cyclic synchronous position mode (csp), first perform homing. Set [Modes of operation (Obj. 6060h)] to "6" (Homing mode), then confirm that [Modes of operation display (Obj. 6061h)] has changed to "6" (Homing mode). For information regarding the settings of other control modes, refer to the following section.

☞ Page 42 Control mode

If performing homing via the controller without using homing mode, refer to the following section.

☞ Page 45 Absolute position detection system configuration

Servo-on

Set the control command issued from the controller to [Controlword (Obj. 6040h)], then change the internal state of the servo amplifier to the "servo-on" state.

For details regarding servo amplifier internal states, refer to the following section.

☞ Page 27 PDS state transitions

Homing

Set the homing method in [Homing method (Obj. 6098h)], then perform homing.

For details regarding homing, refer to "Homing mode (hm) and homing" in the following manual.

📖 MR-JET User's Manual (Function)

Starting servo motor operation

Confirm that homing is complete, then change the control mode to cyclic synchronous mode. Drive the servo motor by giving commands to [Target position (Obj. 607Ah)], etc. in accordance with the desired operation pattern.

Disconnecting the network

To disconnect the network when stopping the operation of equipment, follow the procedure shown below. Failing to follow the procedure exactly may cause [AL. 086.1 Network communication error 1].

1. Stop the servo motor.
2. Set the Shutdown command for [Controlword (Obj. 6040h)] to establish the servo-off state.
3. Switch the state to the Pre-Operational state.
4. Shut off the power of the servo amplifier and the controller.

9.1 Torque limit selection

The torque limit selection function is a function that switches the torque limit value by using Bit 11 (CPTL) and Bit 12 (CNTL) of [Controlword (Obj. 6040h)].

The settings of the torque limit selection ([Obj. 2D6Dh]) are as follows.

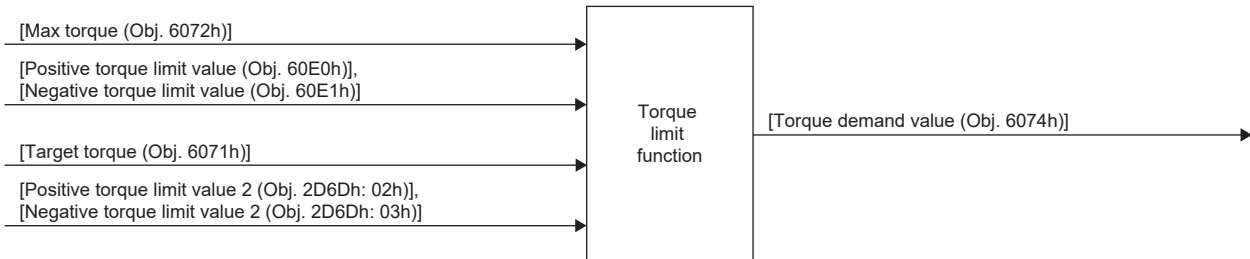

Torque limit

Index	Sub	Name	Data Type	Access	PDO Mapping
2D6Dh	0	Positive/Negative torque limit 2 setting	U8	ro	Impossible
	1	Positive/Negative torque limit 2 select	U16	rw	
	2	Positive torque limit value 2			
	3	Negative torque limit value 2			

Index	Sub	Default	Range	Units	Save	Parameter
2D6Dh	0	3	3h to 3h (3)	—	Impossible	—
	1	0	0000h to 0001h (1)	—	Possible	[Pr. PC42]
	2	10000	0 to 10000	per thousand of rated torque		POL disabled: [Pr. PC43 Forward rotation torque limit 2] POL enabled: [Pr. PC44 Reverse rotation torque limit 2]
	3	10000				POL disabled: [Pr. PC44 Reverse rotation torque limit 2] POL enabled: [Pr. PC43 Forward rotation torque limit 2]

For the combinations of servo parameters and objects that are switched by CPTL/CNTL, refer to the following table.

[Pr. PC42.0]/ [Positive/Negative torque limit 2 select (Obj. 2D6Dh: 01h)]	Forward rotation torque limit value		Reverse rotation torque limit value	
	CPTL: 0	CPTL: 1	CNTL: 0	CNTL: 1
0h/ 0000h	[Pr. PA11]/ [Positive torque limit value (Obj. 60E0h)]	[Pr. PA11]/ [Positive torque limit value (Obj. 60E0h)]	[Pr. PA12]/ [Negative torque limit value (Obj. 60E1h)]	[Pr. PA12]/ [Negative torque limit value (Obj. 60E1h)]
1h/ 0001h	[Pr. PA11]/ [Positive torque limit value (Obj. 60E0h)]	[Pr. PC43]/ [Positive torque limit value 2 (Obj. 2D6Dh: 02h)]	[Pr. PA12]/ [Negative torque limit value (Obj. 60E1h)]	[Pr. PC44]/ [Negative torque limit value 2 (Obj. 2D6Dh: 03h)]

9.2 Infinite feed function

Outline

When this function is used in an absolute position detection system, even if the servo motor rotates 32768 rev or more in the same direction, [AL. 0E3.1 Multi-revolution counter travel distance exceeded warning] will not occur and the home position will not be erased. Therefore, the current position will be restored after the power is cycled. When this function is not used, if the servo motor rotates 32768 rev or more in the same direction, [AL. 0E3.1] will occur and the home position will be erased.

Setting method

Set [Pr. PT85.0 Infinite feed function selection] to "1".

Servo parameter	Name	Description
PT85.0	Infinite feed function selection	0: Disabled 1: Enabled

When the servo motor rotates 32768 rev or more

The following table shows whether [AL. 0E3.1] will occur, the home position will be erased, and the current position will be restored when the servo motor rotates 32768 rev or more.

Control mode	Unit for position data	[AL. 0E3.1]	Home position	Current position
Cyclic synchronous mode	pulse	Will not occur	Will not be erased	Will be restored
Profile mode	degree	Will not occur *1	Will not be erased	Will be restored
	pulse	Will occur *1	Will be erased	Will not be restored
Positioning mode (point table method)	mm	Will occur *1	Will be erased	Will not be restored
	inch	Will occur *1	Will be erased	Will not be restored
	degree	Will not occur *1	Will not be erased	Will be restored
	pulse	Will occur *1	Will be erased	Will not be restored

*1 When [Pr. PC29.5 Absolute position counter warning [AL. 0E3.1] selection] is set to "0" (disabled), [AL. 0E3.1] will not occur and the home position will not be erased. However, if "0" is set while the unit is other than "degree", the current position will not be restored correctly after the power is cycled. As this will result in an incorrect current position value, set [Pr. PC29.5] to "1" (enabled).

Restrictions

The following shows restrictions on when [Pr. PT85.0] is set to "1".

- This function cannot be used in the linear servo motor control mode, or fully closed loop control mode. Setting [Pr. PT85.0] to "1" in these modes triggers [AL. 037 Parameter error].
- The scale measurement function cannot be used. When the scale measurement function is enabled, setting [Pr. PT85.0] to "1" triggers [AL. 037 Parameter error].
- This function can be used only in the cyclic position mode (csp) and homing mode (hm). The mode cannot be switched to other control modes.
- Set values in [Pr. PA06 Electronic gear numerator] and [Pr. PA07 Electronic gear denominator] so that the numerator (m) after reducing the following equation is less than 16384. If "m" is 16384 or more, [AL. 037 Parameter error] will occur.

$$\frac{\text{Unit} \times \text{cmx}}{\text{fbpm} \times \text{cdv}} = \frac{m}{n} \quad m < 16384$$

Unit: 2^{32} (4294967296)

cmx: Electronic gear numerator ([Pr. PA06])

cdv: Electronic gear denominator ([Pr. PA07])

fbpm: Servo motor encoder resolution

Ex.

Setting 2^{26} (67108864) for the encoder resolution and 48:1 for the electronic gear

$$\frac{4294967296 \times 48}{67108864 \times 1} = \frac{3072}{1} \quad 3072 < 16384$$

- When [Pr. PT85.0] is changed while the absolute position detection system is enabled, perform homing again. If homing is not performed, [AL. 090.5 Homing incomplete warning] occurs at the start of an operation.
- Do not rotate the motor 2^{32} (4294967296) [pos units] or more in the forward or reverse rotation direction during power-off. Doing so will cause inaccurate absolute position restoration after the power is turned on.
- LSP (Forward rotation stroke end) and LSN (Reverse rotation stroke end) cannot be used. When the infinite feed function is enabled, LSP and LSN will turn on automatically.
- When the infinite feed function is enabled, the home position will be updated automatically. When the home position is updated, [Position actual value (Obj. 6064h)] will not change, but ABS data in MR Configurator2 will show values after the home position has been updated.

9.3 Safety communication function

Point

When using the safety communication function, use ESI files in Module format.

Safety communication performed via EtherCAT is called FSoE (Safety Over EtherCAT), and the safety sub-function can be used by connecting to a controller that supports functional safety.

For details of the safety sub-function, refer to "FUNCTIONAL SAFETY" in the following manual.

MR-JET User's Manual (Function)

Safety communication function is available on servo amplifiers with firmware version D8 or later.

Safety PDO mapping

When using the safety communication function, use safety PDO ([Obj. 1608h]/ [Obj. 1A08h]).

The safety communication function can be used by adding safety PDO to [Sync Manager RxPDO assign (Obj. 1C12h)] and [Sync Manager TxPDO assign (Obj. 1C13h)].

The configuration of safety PDO is as follows. Refer to the following for details of mapping.

Page 16 PDO (Process Data Object) COMMUNICATION

Index	Sub Index	Description
1608h	00h	Number of entries (24h)
	01h	FSoE Master Command
	02h to 09h	SafeData[0]
	0Ah to 11h	SafeData[1]
	12h	FSoE Master CRC_0
	13h to 1Ah	SafeData[2]
	1Bh to 22h	SafeData[3]
	23h	FSoE Master CRC_1
	24h	FSoE Master ConnectionID
1A08h	00h	Number of entries (24h)
	01h	FSoE Slave Command
	02h to 09h	SafeData[0]
	0Ah to 11h	SafeData[1]
	12h	FSoE Slave CRC_0
	13h to 1Ah	SafeData[2]
	1Bh to 22h	SafeData[3]
	23h	FSoE Slave CRC_1
	24h	FSoE Slave ConnectionID

Safety parameter set

The safety communication function performs a parameter set (FSoE Connection Parameter Set) during the initial sequence of communication, and the parameters related to the safety communication are transferred from the controller to the slave. For details, refer to the following manual.

MR-JET-G-N1 User's Manual (Object Dictionary)

The following shows the data to be transferred by the parameter set.

Description	Supported object
Length of Communication Parameter	Communication Parameter Length (Obj. E901h: 07h)
Watchdog Time	Watchdog Time (Obj. E901h: 04h)
Length of Application Parameter	Application Parameter Length (Obj. E901h: 08h)

Startup

Configuration

The following figure shows a configuration example.

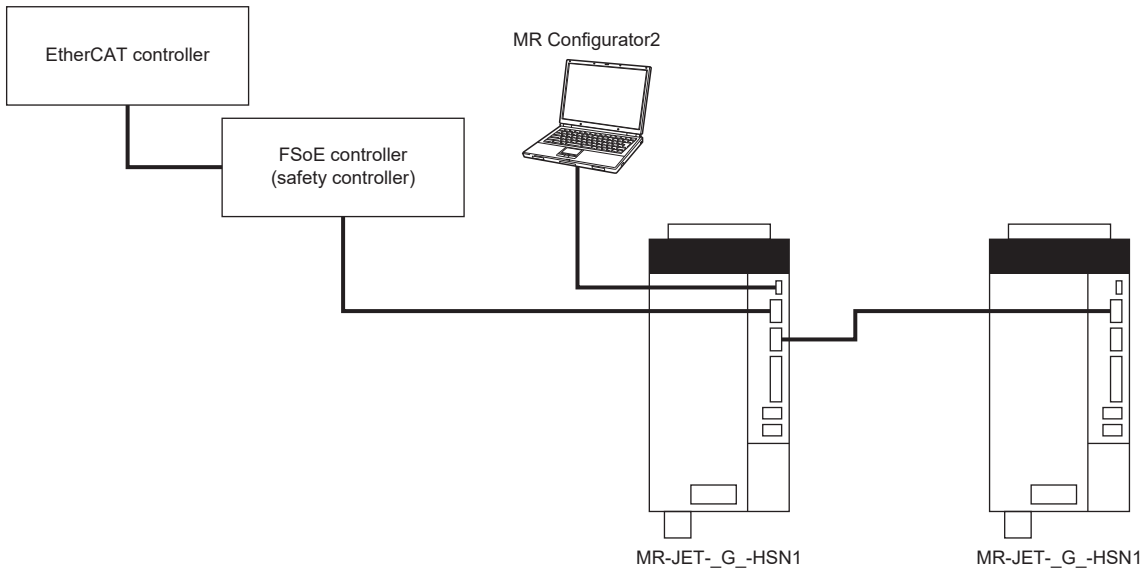

Startup procedure

Point

- Use ESI files that support the Module format.
- Before connecting with the controller, set the functional safety parameters of the servo amplifier. If a network is automatically detected when [Pr. PSA01.1 Input mode selection] is set to "0" (safety sub-function control by input device), FSoE may not be properly configured on the controller side.

Parameter settings

- [Pr. PSA01.0 Safety sub-function activation setting]

Set "1" (enabled) after checking the setting of each functional safety parameter and confirming that there are no errors.

- [Pr. PSA01.1 Input mode selection]

Set "1" (safety sub-function control by network).

- [Pr. PSC07 FSoE Address setting]

Set the FSoE Address of FSoE Slave within the range of 1 to 65355. If [Pr. PSA01.0] is set to "0" when [Pr. PSA01.0] is "1" and [Pr. PSC01.1] is "1", [AL. 537.2 Parameter combination error A (safety sub-function)] occurs.

EtherCAT controller settings

1. ESI file installation

Refer to the following.

 Page 48 ESI file installation

2. Node address setting

Refer to the following.

 Page 48 Node address setting

3. Communication setting

Refer to the following.

 Page 49 Communication setting

4. Mapping settings

Refer to the following. Set the safety PDO mapping in addition to the normal PDO mapping.

 Page 49 Mapping settings

I/O function

Safety sub-function control by network

Outline

Input devices cannot be used for safety sub-function control by network.

The following shows the configuration of process data for safety communication via EtherCAT communication. The safety sub-function can be controlled using the dedicated input/output signal assigned to SafeData[n].



To use the safety communication function through EtherCAT communication, assign [9th Receive PDO Mapping (Obj. 1608h)] and [9th Transmit PDO Mapping (Obj. 1A08h)] to [Sync Manager RxPDO assign (Obj. 1C12h)] and [Sync Manager TxPDO assign (Obj. 1C13h)]. For details of each object, refer to the following manual.

MR-JET-G-N1 User's Manual (Object Dictionary)

Safety sub-function control by network has the following characteristics.

- Transmission of each function command input via a network

The following commands can be transmitted via a network.

Controller to servo amplifier			
SafeData[n]	Bit	Input command	Description
SafeData[0]	0	STOC (STO command)	0: The STO function of the servo amplifier is activated and the energy supply is shut off. 1: The STO status is canceled and normal operation resumes.
	1	SS1C (SS1 command)	0: The SS1 function is activated. 1: The SS1 function is canceled.
	2	Not available	—
	3	Not available	Set to "0".
	4		
	5	SDIPC (SDIP command)	0: The SDIP function is activated. 1: The SDIP function is canceled.
	6	SDINC (SDIN command)	0: The SDIN function is activated. 1: The SDIN function is canceled.
	7	Error Ack (Error clear command)	0 → 1: Cancellation of errors is requested.
SafeData[1]	0	SLS1C (SLS1 command)	0: The SLS1 function is activated. 1: The SLS1 function is canceled.
	1	SLS2C (SLS2 command)	0: The SLS2 function is activated. 1: The SLS2 function is canceled.
	2	SLS3C (SLS3 command)	0: The SLS3 function is activated. 1: The SLS3 function is canceled.
	3	SLS4C (SLS4 command)	0: The SLS4 function is activated. 1: The SLS4 function is canceled.
	4	Not available	—
	5	SLT1C (SLT1 command)	0: The SLT1 function is activated. 1: The SLT1 function is canceled.
	6	SLT2C (SLT2 command)	0: The SLT2 function is activated. 1: The SLT2 function is canceled.
	7	SLT3C (SLT3 command)	0: The SLT3 function is activated. 1: The SLT3 function is canceled.

Controller to servo amplifier			
SafeData[n]	Bit	Input command	Description
SafeData[2]	0	SLT4C (SLT4 command)	0: The SLT4 function is activated. 1: The SLT4 function is canceled.
	1	Not available	Set to "0".
	2		
	3		
	4		
	5		
	6		
	7		
SafeData[3]	0	Not available	Set to "0".
	1		
	2		
	3		
	4		
	5		
	6		
	7		

- Feedback of various function outputs via a network

STOS (STO output), SSMS (SSM output), etc. can be transmitted via a network.

Servo amplifier to controller			
SafeData[n]	Bit	Function output	Description
SafeData[0]	0	STOS (STO output)	0: Indicates that the STO status has been canceled. 1: Indicates that the STO function is activated and the energy supply has been shut off.
	1	SSMS (SSM output)	0: Indicates that the servo motor speed exceeds the set SSM speed. (Off when the SSM function is disabled.) 1: Indicates that the servo motor speed is equal to or less than the set SSM speed.
	2	Not available	—
	3		
	4		
	5		
	6		
7	Error (Error status)	0: Indicates that no error is occurring. 1: Indicates that an error is occurring.	
SafeData[1]	0	SS1S (SS1 output)	0: Indicates that the SS1 function is not activated. 1: Indicates that the SS1 function is activated.
	1	Not available	—
	2	SDIPS (SDIP output)	0: Indicates that the SDIP function is not activated. 1: Indicates that the SDIP function is activated.
	3	SDINS (SDIN output)	0: Indicates that the SDIN function is not activated. 1: Indicates that the SDIN function is activated.
	4	SLS1S (SLS1 output)	0: Indicates that the SLS1 function is not activated. 1: Indicates that the SLS1 function is activated.
	5	SLS2S (SLS2 output)	0: Indicates that the SLS2 function is not activated. 1: Indicates that the SLS2 function is activated.
	6	SLS3S (SLS3 output)	0: Indicates that the SLS3 function is not activated. 1: Indicates that the SLS3 function is activated.
	7	SLS4S (SLS4 output)	0: Indicates that the SLS4 function is not activated. 1: Indicates that the SLS4 function is activated.
SafeData[2]	0	SBCS (SBC output)	0: Indicates that the STO status has been canceled and the energy supply to the electromagnetic brake has not been shut off. 1: Indicates that the STO function is activated and the energy supply to the electromagnetic brake has been shut off.
	1	Not available	—
	2	SLT1S (SLT1 output)	0: Indicates that the SLT1 function is not activated. 1: Indicates that the SLT1 function is activated.
	3	SLT2S (SLT2 output)	0: Indicates that the SLT2 function is not activated. 1: Indicates that the SLT2 function is activated.
	4	SLT3S (SLT3 output)	0: Indicates that the SLT3 function is not activated. 1: Indicates that the SLT3 function is activated.
	5	SLT4S (SLT4 output)	0: Indicates that the SLT4 function is not activated. 1: Indicates that the SLT4 function is activated.
	6	Not available	—
7			
SafeData[3]	0	Not available	—
	1		
	2		
	3		
	4		
	5		
	6		
	7		

FSoE Watchdog Time

For safety sub-function control by network, set FSoE Watchdog Time.

FSoE Watchdog Time is a time-out value for safety process data and it affects the determination of the safety reaction time.

By increasing the value, communication timeouts are less likely to occur.

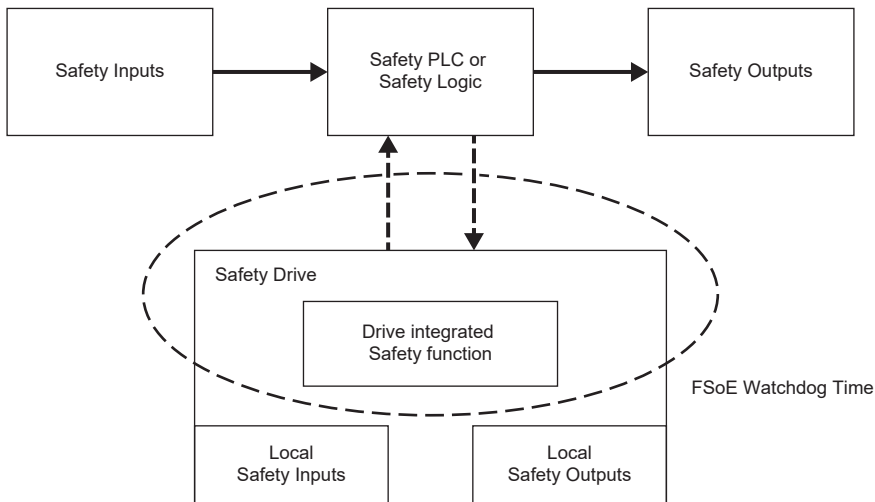

$T_{Ref} + T_{Com} \times 4 = 16$ (Unit: ms) is the minimum configurable value for FSoE Watchdog Time.

Set the FSoE Watchdog Time on the controller, taking into account the response time of the controller used.

Element	Description
TRef	Safety refresh response processing time 15.0 ms
TCom	Network response time Communication cycle: 250 μ s or longer

FSoE Watchdog Time set in [Watchdog Time (Obj. E901h: 04h)] can be checked on the servo amplifier.

Functional safety parameter setting

To perform safety monitoring using the safety communications, set the following parameters.

Parameter	Name
PSC07	FSoE Address setting

- FSoE Address setting

Set the value used to identify FSoE Slave. Ensure that FSoE Slave has a unique value.

Match the value of FSoE Master with this functional safety parameter. If it is set to a non-matching value, [AL. 584.1 FSoE Address mismatch error (safety sub-function)] occurs.

REVISIONS

*The manual number is given on the bottom left of the back cover.

Revision date	*Manual number	Description
November 2019	IB(NA)-0300500ENG-A	First edition
July 2020	IB(NA)-0300500ENG-B	✕The following function is added: Profile mode ✕Added/edited: Section 1.1, Section 1.3, Section 2.1, Section 4.3, Section 4.5, Chapter 6, Section 7.2, Section 7.3, Section 7.4, Chapter 8 ✕Deleted: Section 7.5
November 2020	IB(NA)-0300500ENG-C	✕The following functions are added and changed: Cyclic asynchronous mode, degree unit, identifying slave stations with node addresses ✕Added/edited: Section 6.1, Section 6.3, Section 7.4, Section 8.3
March 2021	IB(NA)-0300500ENG-D	✕The following function is added: Positioning mode (point table method) ✕Edited: Section 1.1, Section 4.3, Section 4.5, Section 6.1, Section 7.3, Section 7.4
July 2021	IB(NA)-0300500ENG-E	✕Edited: Section 7.4, Section 8.2
July 2022	IB(NA)-0300500ENG-F	✕The following functions are added and changed: Fully closed loop system, Ethernet over EtherCAT (EoE), Quick Stop, infinite feed function ✕Added/edited: Section 1.1, Section 1.4, Section 2.1, Section 2.4, Section 9.2
January 2023	IB(NA)-0300500ENG-G	✕The following function is added: Override function ✕The following function is changed: PDO Mapping ✕Added/edited: Section 1.1, Section 3.1, Section 4.2, Section 7.2, Chapter 8, Section 9.2
October 2024	IB(NA)-0300500ENG-H	✕The following model is added: MR-JET_G_HSN1 ✕Added/edited: Section 1.1, Section 2.1, Section 3.1, Section 4.3, Section 4.4, Section 7.3, Chapter 8, Section 9.2, Section 9.3

This manual confers no industrial property rights or any rights of any other kind, nor does it confer any patent licenses. Mitsubishi Electric Corporation cannot be held responsible for any problems involving industrial property rights which may occur as a result of using the contents noted in this manual.

© 2019 MITSUBISHI ELECTRIC CORPORATION

WARRANTY

Warranty

1. Warranty period and coverage

We will repair any failure or defect hereinafter referred to as "failure" in our FA equipment hereinafter referred to as the "Product" arisen during warranty period at no charge due to causes for which we are responsible through the distributor from which you purchased the Product or our service provider. However, we will charge the actual cost of dispatching our engineer for an on-site repair work on request by customer in Japan or overseas countries. We are not responsible for any on-site readjustment and/or trial run that may be required after a defective unit are repaired or replaced.

[Term]

For terms of warranty, please contact your original place of purchase.

[Limitations]

(1) You are requested to conduct an initial failure diagnosis by yourself, as a general rule.

It can also be carried out by us or our service company upon your request and the actual cost will be charged. However, it will not be charged if we are responsible for the cause of the failure.

(2) This limited warranty applies only when the condition, method, environment, etc. of use are in compliance with the terms and conditions and instructions that are set forth in the instruction manual and user manual for the Product and the caution label affixed to the Product.

(3) Even during the term of warranty, the repair cost will be charged on you in the following cases;

1. a failure caused by your improper storing or handling, carelessness or negligence, etc., and a failure caused by your hardware or software problem
2. a failure caused by any alteration, etc. to the Product made on your side without our approval
3. a failure which may be regarded as avoidable, if your equipment in which the Product is incorporated is equipped with a safety device required by applicable laws and has any function or structure considered to be indispensable according to a common sense in the industry
4. a failure which may be regarded as avoidable if consumable parts designated in the instruction manual, etc. are duly maintained and replaced
5. any replacement of consumable parts (battery, fan, smoothing capacitor, etc.)
6. a failure caused by external factors such as inevitable accidents, including without limitation fire and abnormal fluctuation of voltage, and acts of God, including without limitation earthquake, lightning and natural disasters
7. a failure generated by an unforeseeable cause with a scientific technology that was not available at the time of the shipment of the Product from our company
8. any other failures which we are not responsible for or which you acknowledge we are not responsible for

2. Term of warranty after the stop of production

(1) We may accept the repair at charge for another seven (7) years after the production of the product is discontinued. The announcement of the stop of production for each model can be seen in our Sales and Service, etc.

(2) Please note that the Product (including its spare parts) cannot be ordered after its stop of production.

3. Service in overseas countries

Our regional FA Center in overseas countries will accept the repair work of the Product. However, the terms and conditions of the repair work may differ depending on each FA Center. Please ask your local FA center for details.

4. Exclusion of loss in opportunity and secondary loss from warranty liability

Regardless of the gratis warranty term, Mitsubishi shall not be liable for compensation to:

- (1) Damages caused by any cause found not to be the responsibility of Mitsubishi.
- (2) Loss in opportunity, lost profits incurred to the user by Failures of Mitsubishi products.
- (3) Special damages and secondary damages whether foreseeable or not, compensation for accidents, and compensation for damages to products other than Mitsubishi products.
- (4) Replacement by the user, maintenance of on-site equipment, start-up test run and other tasks.

5. Change of Product specifications

Specifications listed in our catalogs, manuals or technical documents may be changed without notice.

6. Application and use of the Product

- (1) For the use of our AC Servo, its applications should be those that may not result in a serious damage even if any failure or malfunction occurs in AC Servo, and a backup or fail-safe function should operate on an external system to AC Servo when any failure or malfunction occurs.
- (2) Our AC Servo is designed and manufactured as a general purpose product for use at general industries. Therefore, applications substantially influential on the public interest for such as atomic power plants and other power plants of electric power companies, and also which require a special quality assurance system, including applications for railway companies and government or public offices are not recommended, and we assume no responsibility for any failure caused by these applications when used.
In addition, applications which may be substantially influential to human lives or properties for such as airlines, medical treatments, railway service, incineration and fuel systems, man-operated material handling equipment, entertainment machines, safety machines, etc. are not recommended, and we assume no responsibility for any failure caused by these applications when used. We will review the acceptability of the abovementioned applications, if you agree not to require a specific quality for a specific application. Please contact us for consultation.
- (3) Mitsubishi Electric shall have no responsibility or liability for any problems involving programmable controller trouble and system trouble caused by DoS attacks, unauthorized access, computer viruses, and other cyberattacks.

TRADEMARKS

MELSERVO is a trademark or registered trademark of Mitsubishi Electric Corporation in Japan and/or other countries.
EtherCAT[®] is a registered trademark and patented technology licensed by Beckhoff Automation GmbH, Germany.
All other product names and company names are trademarks or registered trademarks of their respective companies.

IB(NA)-0300500ENG-H(2410)MEE

MODEL:

MODEL CODE:

MITSUBISHI ELECTRIC CORPORATION

HEAD OFFICE: TOKYO BLDG., 2-7-3, MARUNOUCHI, CHIYODA-KU, TOKYO 100-8310, JAPAN
NAGOYA WORKS: 1-14, YADA-MINAMI 5-CHOME, HIGASHI-KU, NAGOYA 461-8670, JAPAN

When exported from Japan, this manual does not require application to the
Ministry of Economy, Trade and Industry for service transaction permission.

Specifications are subject to change without notice.

Compliance with the indicated global standards and regulations is current as of the release date of this manual.