

CL1X4-D1B2 CC-Link/LT Remote I/O Module

Please read this manual thoroughly before starting to use the product and handle the product properly.

User's Manual

MODEL	CL1X4-D1B2
MANUAL Number	JY97D04101J
Date	November 2021

CC-Link/LT

SAFETY PRECAUTIONS

Read these precautions before using. Please read this manual carefully and pay special attention to safety in order to handle this product properly. Also pay careful attention to safety and handle the module properly. These precautions apply only to Mitsubishi equipment. Refer to the user's manual of the CPU module to use for a description of the PLC system safety precautions.

These SAFETY PRECAUTIONS classify the safety precautions into two categories: "WARNING" and "CAUTION".

WARNING Procedures which may lead to a dangerous condition and cause death or serious injury if not carried out properly.

CAUTION Procedures which may lead to a dangerous condition and cause superficial to medium injury, or physical damage only, if not carried out properly.

Depending on circumstances, procedures indicated by CAUTION may also be linked to serious results. In any case, it is important to follow the directions for usage. Store this manual in a safe place so that you can take it out and read it whenever necessary. Always forward it to the end user.

DESIGN PRECAUTIONS

WARNING

- Configure an interlock circuit in a sequence program so that the system operates on the safe side using the communication status information in the event the data link falls into a communication problem.
- Otherwise, erroneous output and malfunction may result in accidents.
- Remote input and output can not be switched ON or OFF when a problem occurs in the remote I/O modules. Therefore build an external monitoring circuit that will monitor any input signals that could cause a serious accident.

CAUTION

- Do not have control cables and communication cables bundled with or placed near by the main circuit and/or power cables. Wire those cables at least 100mm(3.94 inch) away from the main circuit and/or power cables. It may cause malfunction due to noise interference.
- Use the module and the flat cable dedicated to CC-Link/LT without applying any force on them. Otherwise, such cables may be broken or fail.

INSTALLATION PRECAUTIONS

CAUTION

- Use the module in an environment that meets the general specifications contained in this manual. Using this module in an environment outside the range of the general specifications could result in electric shock, fire, erroneous operation, and damage to or deterioration of the product.
- Do not directly touch the module's conductive parts. Doing so could cause malfunction or trouble in the module.
- Tighten the module securely using DIN rail or installation screws within the specified torque range. If the screws are too loose, the module may drop from its installation position, short circuit, or malfunction. If the screws are too tight, the screws may be damaged, which may cause the module to drop from its installation position or short circuit.
- Install the module on a flat surface. If the mounting surface has concave and/or convex, an excessive force may be applied on the module, and nonconformity may be caused.

WIRING PRECAUTIONS

WARNING

Perform installation and wiring after disconnecting the power supply at all phases externally. If the power is not disconnected at all phases an electric shock or product damage may result.

When using a three-wire type sensor (when using the power supply for sensor other than 24V DC)

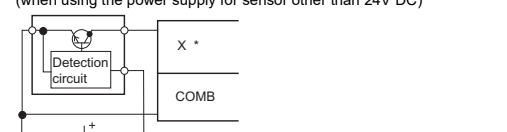

Negative common (PNP)

When using a two-wire type sensor • When using a three-wire type sensor

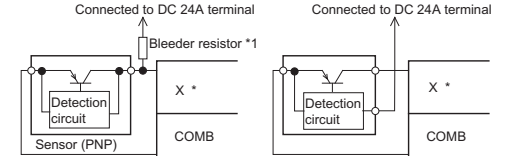

When using a three-wire type sensor (when using the power supply for sensor other than 24V DC)

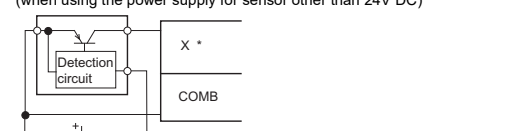

Replace * in the figure with the used input No.

Notes:
 *1 Bleeder resistor
 When connecting a two-wire type sensor or input equipment containing a parallel resistor, select a sensor or equipment whose leakage current is 1.7mA or less. If the leakage current is more than 1.7mA, connect a bleeder resistor obtained in the following calculation formula.
 Circuit image

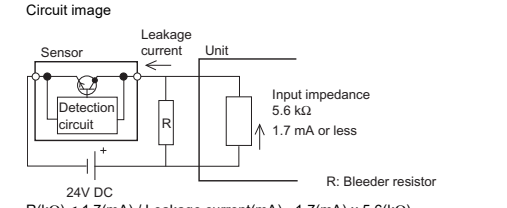

The power capacity W of the bleeder resistor R is as follows:
 $W = (Input\ voltage) / R$
 • If chattering is present in the external input equipment, set 1.5ms.
 • If the ON or OFF time of the input signal is less than 1.5 ms, set it to 0.5 ms. (The ON and OFF time of the input signal are required to be 0.5 ms or more.)

4.3 Crimp-style terminal

For I/O wiring, use crimp-style terminals of the following dimensions.

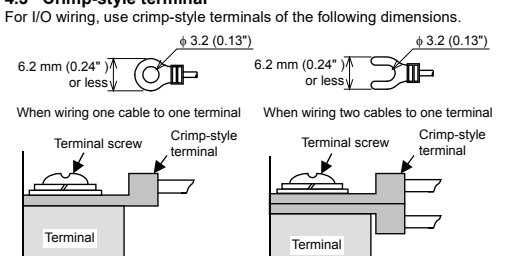

Applicable crimp-style terminal	• RAV1.25-3 • V1.25-3 (manufactured by JST Mfg. Co., Ltd.) • 1.25-3 and TG1.25-3 (manufactured by NICHIFU Co., Ltd.)
Applicable wire size	0.3 to 1.25 mm ²

Use a crimp-style terminal in a status in which no force is applied on the cable.

CAUTION

- Terminal screws which are not to be used must be tightened always. Otherwise there will be a danger of short circuit against the bare solderless terminals.
- Perform correct wiring for the module according to the product's rated voltage and terminal arrangement. Connecting to a power supply different from rating or miss-wiring may cause fire, product failure or malfunction.
- Fix terminal screws securely within the regulated torque. Loose terminal screws may cause fire and/or malfunction. If the terminal screws are too tight, it may cause short circuit, equipment failures, or erroneous operation due to damage of the screws.
- Make sure foreign objects do not get inside the module, such as dirt and wire chips. It may cause fire, product failure or malfunction.
- Attach a warning label (hazard symbol 417-IEC-5036) concerning the electric shock to the location.

(STARTING AND MAINTENANCE PRECAUTIONS)

WARNING

- Do not touch the terminals when the power is ON. It may cause an electric shock or malfunction.
- Perform cleaning the module or retightening of terminal screws after turning OFF the all external power supply for sure. Failure to do so may cause failure or malfunction of the modules.

CAUTION

- Do not disassemble or modify the module. Doing so may cause failure, malfunction, injury, or fire.
- The module case is made of resin; do not drop it or subject it to strong shock. A module damage may result all phases of the external power supply OFF before installing or removing the module to/from the panel. Failure to do so may cause failure or malfunction of the modules.

(DISPOSAL PRECAUTIONS)

CAUTION

- When disposing of this product, treat it as industrial waste.

(TRANSPORTATION AND MAINTENANCE PRECAUTIONS)

CAUTION

- During transportation avoid any impact as the module is a precision instrument. Doing so could cause trouble in the module.
- If necessary to check the operation of module after transportation, in case of any impact damage.

Compliance with EC directive (CE marking)

This notification does not guarantee that an entire mechanical module produced in accordance with the contents of the notification comply with the following standards. Compliance to EMC directive of the entire mechanical module should be checked by the user / manufacturer.

Attention

This product is designed for use in industrial applications.

Standards with which this product complies
 Type : Programmable Controller (Open Type Equipment) Remote I/O module
 Models : Products manufactured from November 1st, 2002 to April 30th, 2006 are compliant with EN61000-6-4 and EN61131-2:1994+A11:1996+A12:2000 after May 1st, 2006 are compliant with EN61131-2:2007

Electromagnetic Compatibility Directive (EMC)	Remark
EN61000-6-4:2007 Electromagnetic compatibility -Generic standards - Emission standard for Industrial environment	Compliance with all relevant aspects of the standard. Radiated Emissions and Mains Terminal Voltage Emissions)
EN61131-2:1994/A11:1996/A12:2000 Programmable controllers -Equipment requirements and tests	Compliance with all relevant aspects of the standard. • Radiated electromagnetic field • Fast transient burst • Electrostatic discharge • Damped oscillatory wave
EN61131-2:2007 Programmable controllers -Equipment requirements and tests	Compliance with all relevant aspects of the standard. EMC • Radiated Emission • Conducted Emission EMS • Radiated electromagnetic field • Fast transient burst • Electrostatic discharge • High-voltage surge • Voltage drops and interruptions • Conducted RF • Power frequency magnetic field

Notes for compliance to EMC directive
 • It is necessary to install the CL1 series module in a shielded metal control panel. For more details, please contact the local Mitsubishi Electric sales site.

4.4 Module terminal screw

Tighten the terminal screws (M3 screws) on the terminal block with a tightening torque of 0.42 to 0.58 N·m. Do not tighten terminal screws with a torque outside the above-mentioned range. Failure to do so may cause short circuit, equipment failures, or malfunctions.

5. Specifications

5.1 General specifications

Item	Specification			
Ambient working temperature	0 to 55°C (32 to 131°F)			
Ambient storage temperature	-25 to 75°C (-13 to 167°F)			
Ambient operating humidity	5 to 95%RH; Dew condensation shall not be considered.			
Ambient storage humidity	5 to 95%RH; Dew condensation shall not be considered.			
Vibration resistance (*1)	When intermittent vibration is present			
	Frequency	Acceleration	Half amplitude	10 times in each of X, Y and Z directions (for 80 min)
	10 to 57Hz	—	0.075mm	
57 to 150Hz	9.8m/s ²	—		
Impact resistance (*1)	When continuous vibration is present	Number of times of sweep		
	Frequency		Acceleration	Half amplitude
	10 to 57Hz		—	0.035mm
57 to 150Hz	4.9m/s ²	—		
Operating atmosphere	Corrosive gas shall not be present.			
Operating altitude	2,000m(6561'8") or less (*2)			
Installation place	Inside control panel (*3)			
Over-voltage category	II or less (*4)			
Degree of contamination	2 or less (*5)			

Notes:
 *1 The criterion is shown in IEC61131-2.
 *2 The module cannot be used in an environment pressurized above the atmospheric pressure which can be generated around the altitude of 0 m. If the module is used in such an environment, it may fail.
 *3 The module can be used in any environment even outside the control panel as far as the requirements of the ambient operating temperature, the ambient operating humidity, etc. are satisfied.
 *4 This indicates the section of the power supply to which the equipment is assumed to be connected between the public electrical power distribution network and the machinery within premises. Category II applies to equipment for which electrical power is supplied from fixed facilities. The surge voltage withstand level for up to the rated voltage of 300V is 2500V.
 *5 This index indicates the degree of conductive generating substances in the environment in which the module is used. The degree of contamination 2 indicates that contamination is caused by generation of only non-conductive substances.
 In this degree, however, temporary conduction may be caused by accidental condensation.

5.2 Input specifications

Item	Specification	
Input method	DC input (External power supply of the input part)	
Number of inputs	4 points	
Isolation method	Isolation with photocoupler	
Rated input voltage	24V DC	
Rated input current	Approx. 4 mA	
Operating voltage range	20.4 to 28.8V DC (-15% to +20%) Ripple ratio: Within 5%	
Max. simultaneous ON input points	100% (at 24V DC)	
ON voltage/ON current	19 V or more/3 mA or more	
OFF voltage/OFF current	11 V or less/1.7 mA or less	
Input resistance	5.6 kΩ	
Response time	OFF→ON	0.5ms/1.5 ms or less (at 24V DC) Selected by DIP switch (default value = OFF/1.5ms).
	ON→OFF	0.5ms/1.5 ms or less (at 24V DC) Selected by DIP switch (default value = OFF/1.5ms).
Common wiring method	4 points/1 common (2 points) (terminal block two-wire type)	

• Use this product in Zone A*1 as defined in EN61131-2.

*1 Zone defined in EN61131-2
 Separation defined in EN61131-2 for EMC LVD regulation decided depending on condition in industrial setting.
 Zone C = Factory mains which is isolated from public mains by dedicated transformers.
 Zone B = Dedicated power distribution which is protected by secondary surge protection. (300V or less in the rated voltage is assumed.)
 Zone A = Local power distribution which is isolated from dedicated power distribution by AC/DC converters, isolation transformers, etc. (120V or less in the rated voltage is assumed.)

Compliance with UKCA marking

The requirements for compliance with UKCA marking are the same as that with EC directive (CE marking).

1. Outline of Product

This product is a terminal block type input module connected to CC-Link/LT. This product has four input points (24V DC).

2. Name and Setting of Each Part and Terminal Arrangement

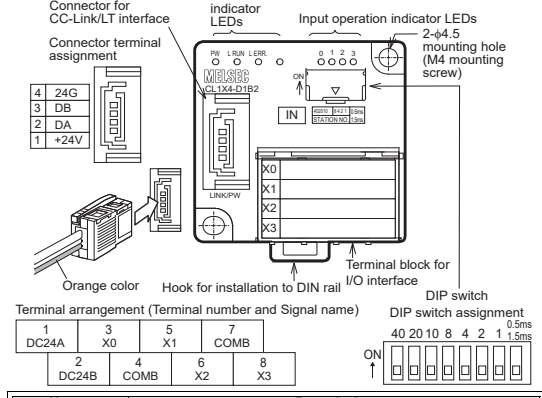

Name	Description
Status indicator LED	PW ON while the power is supplied.
	L RUN ON while normal operation is executed. ON: When a communication error or DIP switch setting error occurred. Fllickering at a constant interval: When the setting of the DIP switch was changed while the power was supplied (even while the LED is flickering, the operation continues. The new setting becomes valid when the power is turned OFF once, then ON again.) Fllickering at an intermittent interval: When a terminal resistor is not attached or when the module or a connection cable is affected by noise
Input operation indicator LED	ON while the input is ON. Extinguished while the input is OFF.
Interface	Connector for CC-Link/LT communication line/module power supply (24G/DB/DA+24V)
Terminal block for I/O interface	Terminal block for connecting input signals and I/O power supply
DIP switch	Set the 10's digit of the station No. using "STATION NO. 10", "STATION NO. 20" and "STATION NO. 40". Set the 1's digit of the station No. using "STATION NO. 1", "STATION NO. 2", "STATION NO. 4" and "STATION NO. 8". Factory default = All bits are OFF. Make sure to set the station No. in the range from 1 to 64. If any station No. outside the range from 1 to 64 is set, it is regarded as an error and the L.ERR. LED lights. Example: When setting the station No. to "32", set the DIP switch as follows.
	Station No. 32: OFF ON ON OFF OFF ON OFF
DIP switch	0.5ms 1.5ms Sets the response speed. ON: 0.5 ms (fast response type) OFF: 1.5 ms (standard type)

5.3 Performance specifications

Item	Specification	
Module power supply	Voltage	20.4 to 28.8V DC (24V DC -15% to +20%) Ripple ratio: Within 5%
	Current consumption	40mA (when all points are ON)
	Initial current	70mA
	Max. allowable momentary power failure period	PS1:1ms
Number of stations occupied	4-, 8- or 16-point mode: 1 station	
Noise durability	500Vp-p Noise width: 1μs Cycle: 25 to 60 Hz (by noise simulator)	
Withstand voltage	500V AC for 1 min	
Isolation resistance	10 MΩ or higher between primary area (external DC terminal) and secondary area (internal circuit) by 500V DC insulation resistance tester	
Protection class	IP2X	
I/O part connection method	Connection with terminal block	
Module installation method	DIN rail installation, mounted by screws of type M4 × 0.7mm(0.03") × 16mm(0.63") or larger Can be installed in six directions	
Mass (weight)	0.06 kg (0.13 lbs)	

6. Outside Dimensions

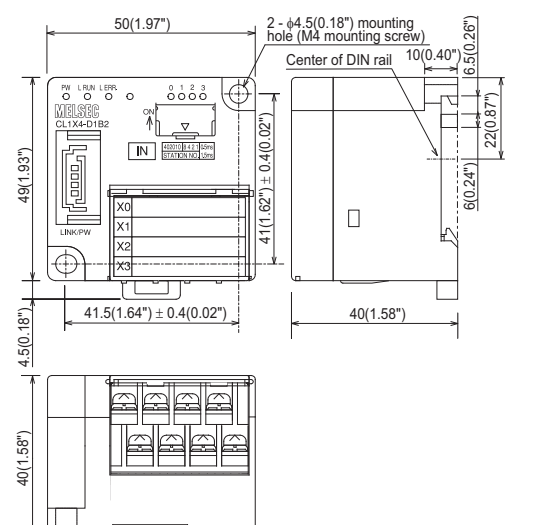

Unit: mm(inches)

3. Installation

The CL1X4-D1B2 can be installed to DIN rail or directly installed using mounting screws.

Each installation procedure is described below.

3.1 Installation to DIN rail

Align the upper DIN rail installation groove in the module with the DIN rail 1, and press the module in that status 2). When removing the module, pull the hook downward for installation to DIN rail 3), then remove the module 4).

DIN rail mounting screw pitch

When installing the module to the DIN rail, tighten the mounting screws at the pitch of 200mm(7.87") or less.

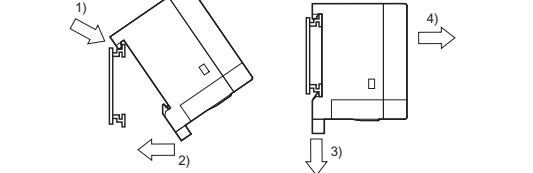

[Applicable DIN rail TH35-7.5Fe and TH35-7.5Al]

3.2 Direct installation

Screw-tighten the module by attaching M4 screws to the upper and lower mounting holes (two holes in all) provided in the module. Install the module so that the clearance of 1 to 2mm (0.04" to 0.08") is assured for each module.

Applicable screw	M4 × 0.7mm(0.03") × 16mm(0.63") or more (Tightening torque range: 0.78 to 1.08 N·m)
------------------	--

4. Wiring

4.1 External wiring

The input terminals of the CL1X4-D1B2 can be wired as positive common or negative common depending on the used sensor.

Positive common

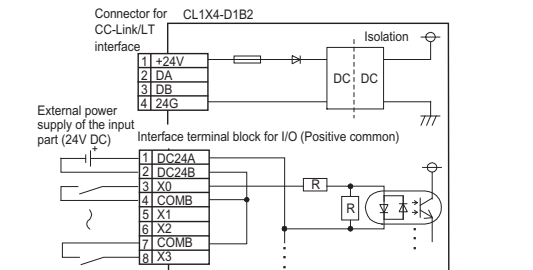

Negative common

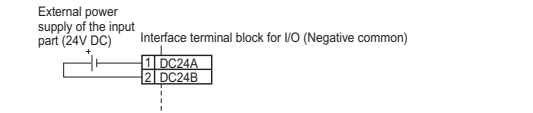

4.2 Connection to sensor

Positive common (NPN)

When using a two-wire type sensor • When using a three-wire type sensor

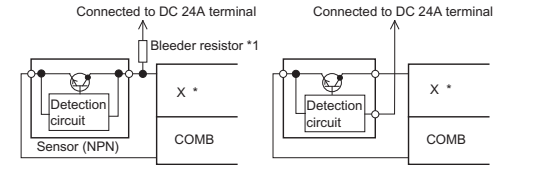

「电器电子产品有害物质限制使用标识要求」的表示方式

Note: This symbol mark is for China only.

含有有害6物质的名称, 含有量, 含有部品
 本产品中所含有的有害6物质的名称, 含有量, 含有部品如下表所示。

部件名称	有害物质					
	铅 (Pb)	汞 (Hg)	镉 (Cd)	六价铬 (Cr (VI))	多溴联苯 (PBB)	多溴二苯醚 (PBDE)
可编程序控制器	○	○	○	○	○	○
印刷基板	×	○	○	○	○	○

本表格依据SJ/T 11364的规定编制。

○: 表示该有害物质在该部件所有均质材料中的含量均在GB/T 26572规定的限量要求以下。
 ×: 表示该有害物质至少在该部件的某一均质材料中的含量超出GB/T 26572规定的限量要求。

基于中国标准法的参考规格: GB/T15969.2

Warranty

Exclusion of loss in opportunity and secondary loss from warranty liability

Regardless of the gratis warranty term, Mitsubishi shall not be liable for compensation to:
 (1) Damages caused by any cause found not to be the responsibility of Mitsubishi.
 (2) Loss in opportunity, lost profits incurred to the user by Failures of Mitsubishi products.
 (3) Special damages and secondary damages whether foreseeable or not, compensation for accidents, and compensation for damages to products other than Mitsubishi products.
 (4) Replacement by the user, maintenance of on-site equipment, start-up test run and other tasks.

For safe use

This product has been manufactured as a general-purpose part for general industries, and has not been designed or manufactured to be incorporated in a device or system used in purposes related to human life.
 • Before using the product for special purposes such as nuclear power, electric power, aerospace, medicine or passenger movement vehicles, consult with Mitsubishi Electric.
 • This product has been manufactured under strict quality control. However when installing the product where major accidents or losses could occur if the product fails, install appropriate backup or failsafe functions in the system.

Country/Region Sales office/Tel	USA	MITSUBISHI ELECTRIC AUTOMATION, INC. 500 Corporate Woods Parkway, Vernon Hills, IL 60061, U.S.A. Tel: +1-847-478-2100/+1-847-478-2500 (NC) Brazil	China	MITSUBISHI ELECTRIC AUTOMATION (CHINA) LTD. No. 1386 Hongqiao Road, Mitsubishi Electric Automation Center, Changning District, Shanghai, China. Tel: +86-21-2322-3030 Germany	Taiwan	MITSUBISHI ELECTRIC EUROPE B.V. German Branch Mitsubishi-Electro-Platz 1, 40882 Ratingen, Germany Tel: +49-2102-486-0 UK	Korea	MITSUBISHI ELECTRIC EUROPE B.V. UK Branch Travelers Lane, Hatfield, Hertfordshire, AL10 8XB, UK Tel: +44-1707-28-8780 Italy	Singapore	MITSUBISHI ELECTRIC EUROPE B.V. Italian Branch Centro Direzionale Colonna - Palazzo Siro, Viale Colonna 7, 20094 Agrate Branza (MB), Italy Tel: +39-039-62511/+39-039-6251-3421 (NC) Spain	Thailand	MITSUBISHI ELECTRIC EUROPE B.V. Spanish Branch Cametres de Rubí, 75-80-AC, 420, E-08190 Sant Cugat del Valles (Barcelona), Spain Tel: +34-93-956-3151/+34-93-956-2260 (NC) France	Indonesia	MITSUBISHI ELECTRIC EUROPE B.V. French Branch 25, Boulevard des Bouteviers, F-92741 Nanterre Cedex, France Tel: +33-1-55-69-55-68 Czech Republic	India	MITSUBISHI ELECTRIC EUROPE B.V. Czech Branch, Prague Office Pekarska 62/17, 115 00 Praha 5, Czech Republic Tel: +420-255-719-200 Poland	Polish Branch	Mitsubishi Electric Europe B.V. Polish Branch ul. Krakowska 48, 32-063 Balice, Poland Tel: +48-12-347-65-00	Australia	MITSUBISHI ELECTRIC AUSTRALIA PTY. LTD. 348 Victoria Road PO BOX111, Rydalmere, N.S.W 2116, Australia Tel: +61-2-9684-7777
---------------------------------	-----	--	-------	---	--------	--	-------	--	-----------	--	----------	---	-----------	--	-------	---	---------------	---	-----------	--

MITSUBISHI ELECTRIC CORPORATION

HEAD OFFICE: TOKYO BUILDING, 2-3 MARUNOUCHI, CHYUO-KU, TOKYO 100-8310, JAPAN

When exported from Japan, this manual does not require application to the Ministry of Economy, Trade and Industry for service transaction permission.

Specifications subject to change without notice.