

MELSOFT

Engineering Software

CPU Module Logging Configuration Tool Version 1 Operating Manual

-SW1DNN-LLUTL-M

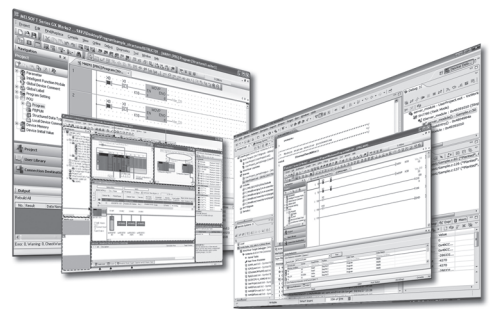



SAFETY PRECAUTIONS

(Read these precautions before using this product.)

Before using this product, please read this manual carefully and pay full attention to safety to handle the product correctly. If the equipment is used in a manner not specified by the manufacturer, the protection provided by the equipment may be impaired.

The precautions given in this manual are concerned with this product only. For the safety precautions of the programmable controller system, refer to the user's manual for the module used and the MELSEC iQ-R Module Configuration Manual. In this manual, the safety precautions are classified into two levels: "⚠ WARNING" and "⚠ CAUTION".

 WARNING	Indicates that incorrect handling may cause hazardous conditions, resulting in death or severe injury.
 CAUTION	Indicates that incorrect handling may cause hazardous conditions, resulting in minor or moderate injury or property damage.

Under some circumstances, failure to observe the precautions given under "⚠ CAUTION" may lead to serious consequences.

Observe the precautions of both levels because they are important for personal and system safety.

Make sure that the end users read this manual and then keep the manual in a safe place for future reference.

[Security Precautions]

WARNING

- To maintain the security (confidentiality, integrity, and availability) of the programmable controller and the system against unauthorized access, denial-of-service (DoS) attacks, computer viruses, and other cyberattacks from external devices via the network, take appropriate measures such as firewalls, virtual private networks (VPNs), and antivirus solutions.
-

[Startup and Maintenance Precautions]

CAUTION

- For online operations performed from a personal computer to a running CPU module, read the relevant manuals carefully and ensure that the operation is safe before proceeding.
-

CONDITIONS OF USE FOR THE PRODUCT

- (1) MELSEC programmable controller ("the PRODUCT") shall be used in conditions;
- i) where any problem, fault or failure occurring in the PRODUCT, if any, shall not lead to any major or serious accident; and
 - ii) where the backup and fail-safe function are systematically or automatically provided outside of the PRODUCT for the case of any problem, fault or failure occurring in the PRODUCT.
- (2) The PRODUCT has been designed and manufactured for the purpose of being used in general industries. MITSUBISHI ELECTRIC SHALL HAVE NO RESPONSIBILITY OR LIABILITY (INCLUDING, BUT NOT LIMITED TO ANY AND ALL RESPONSIBILITY OR LIABILITY BASED ON CONTRACT, WARRANTY, TORT, PRODUCT LIABILITY) FOR ANY INJURY OR DEATH TO PERSONS OR LOSS OR DAMAGE TO PROPERTY CAUSED BY the PRODUCT THAT ARE OPERATED OR USED IN APPLICATION NOT INTENDED OR EXCLUDED BY INSTRUCTIONS, PRECAUTIONS, OR WARNING CONTAINED IN MITSUBISHI ELECTRIC USER'S, INSTRUCTION AND/OR SAFETY MANUALS, TECHNICAL BULLETINS AND GUIDELINES FOR the PRODUCT.
- ("Prohibited Application")
- Prohibited Applications include, but not limited to, the use of the PRODUCT in;
- Nuclear Power Plants and any other power plants operated by Power companies, and/or any other cases in which the public could be affected if any problem or fault occurs in the PRODUCT.
 - Railway companies or Public service purposes, and/or any other cases in which establishment of a special quality assurance system is required by the Purchaser or End User.
 - Aircraft or Aerospace, Medical applications, Train equipment, transport equipment such as Elevator and Escalator, Incineration and Fuel devices, Vehicles, Manned transportation, Equipment for Recreation and Amusement, and Safety devices, handling of Nuclear or Hazardous Materials or Chemicals, Mining and Drilling, and/or other applications where there is a significant risk of injury to the public or property.
- Notwithstanding the above restrictions, Mitsubishi Electric may in its sole discretion, authorize use of the PRODUCT in one or more of the Prohibited Applications, provided that the usage of the PRODUCT is limited only for the specific applications agreed to by Mitsubishi Electric and provided further that no special quality assurance or fail-safe, redundant or other safety features which exceed the general specifications of the PRODUCTS are required. For details, please contact the Mitsubishi Electric representative in your region.
- (3) Mitsubishi Electric shall have no responsibility or liability for any problems involving programmable controller trouble and system trouble caused by DoS attacks, unauthorized access, computer viruses, and other cyberattacks.

INTRODUCTION

Thank you for your patronage. We appreciate your purchase of the engineering software, MELSOFT series.

This manual describes the operations of CPU Module Logging Configuration Tool.

Before using this product, please read this manual carefully, and develop familiarity with the functions and performance of CPU Module Logging Configuration Tool to handle the product correctly.

Note that the menu names and operating procedures may differ depending on an operating system in use and its version.

When reading this manual, replace the names and procedures with the applicable ones as necessary.

CONTENTS

SAFETY PRECAUTIONS	1
CONDITIONS OF USE FOR THE PRODUCT	2
INTRODUCTION	3
RELEVANT MANUALS	6
TERMS	7
GENERIC TERMS AND ABBREVIATIONS	7
CHAPTER 1 OVERVIEW	8
CHAPTER 2 SYSTEM CONFIGURATION	10
2.1 Operating Environment	10
2.2 Communication Routes	10
Connection to a CPU module from a personal computer	11
Connection to a CPU module via a GOT	15
CHAPTER 3 OBTAINING AND START of CPU Module Logging Configuration Tool	16
3.1 How to Obtain	16
3.2 Installation and Uninstallation	16
3.3 Start and End	17
3.4 Display Language Switching	18
CHAPTER 4 SCREEN CONFIGURATION	19
4.1 Main Window	19
4.2 Menu Configuration	20
CHAPTER 5 PROJECT MANAGEMENT	21
5.1 Creating a New Project	21
5.2 Opening a Project	21
5.3 Saving a Project	21
5.4 Reading Logging Settings from an SD Memory Card	22
5.5 Writing Logging Settings into an SD Memory Card	23
5.6 Reading a GX Works3 Project	24
CHAPTER 6 DATA LOGGING SETTING	25
6.1 Data Logging Setting for MX Controllers	25
Logging setting list screen	25
Logging type setting	26
Sampling	27
Data	29
Trigger	33
Number of records	36
Output	37
Save	39
Movement	40
Finish	41
6.2 Data Logging Setting for RCPUs	42
Logging setting list screen	42
Logging type setting	43

Sampling	44
Data	46
Trigger	50
Number of Records	51
Output	52
Save	54
File Transfer	55
Movement	56
Finish	57
CHAPTER 7 COMMON SETTING	58
7.1 Auto Logging Common Setting	58
CHAPTER 8 READING/WRITING/DELETING LOGGING SETTINGS	60
8.1 Reading Logging Settings	62
8.2 Writing Logging Settings	63
8.3 Deleting Logging Settings	64
CHAPTER 9 CHECKING STATUS AND EXECUTING/STOPPING LOGGING	65
CHAPTER 10 SAVING/DELETING DATA LOGGING FILES	67
CHAPTER 11 CHECKING FILE TRANSFER STATUS OF DATA LOGGING FILES	69
CHAPTER 12 HELP OPERATIONS	71
12.1 Opening Manual	71
12.2 Connection to MITSUBISHI ELECTRIC FA Global Website	71
12.3 Version Information	71
APPENDIX	73
Appendix 1 Additions and Changes from Previous Version	73
Appendix 2 Version Compatibility	75
Appendix 3 Supported Characters	76
Supported characters for CPU Module Logging Configuration Tool	76
Supported characters for the file name and the folder (directory) name	76
Appendix 4 USB Driver Installation Procedure	77
REVISIONS	78
INFORMATION AND SERVICES	79
TRADEMARKS	79

RELEVANT MANUALS

The following manuals are relevant to this product.

Manual name [manual number]	Description
CPU Module Logging Configuration Tool Version 1 Operating Manual [SH-082478ENG] (this manual)	System configurations, operations, and setting methods when using CPU Module Logging Configuration Tool
MELSEC iQ-R Programmable Controller CPU Module User's Manual [SH-082488ENG]	Procedures before operation, specifications, devices, memory, functions, parameters, and troubleshooting of the programmable controller CPU module
MELSEC iQ-R Process CPU Module User's Manual [SH-082493ENG]	Procedures before operation, specifications, devices, memory, functions, parameters, and troubleshooting of the process CPU module
MELSEC iQ-R CPU Module User's Manual (Application) [SH-081264ENG]	Memory, functions, devices, and parameters of the CPU module
MELSEC MX Controller (MX-R Model) User's Manual [SH-082641ENG]	Procedures before operation, specifications, devices, memory, functions, parameters, and troubleshooting of the MX Controller
MELSEC MX Controller (MX-F Model) User's Manual [SH-082634ENG]	Procedures before operation, specifications, devices, memory, functions, parameters, and troubleshooting of the MX Controller
MELSEC MX Controller (MX-R Model) Programming Manual [SH-082644ENG]	Program language specifications, MX Controller instructions, standard functions/function blocks, and specifications of motion control function blocks
MELSEC MX Controller (MX-F Model) Programming Manual [SH-082691ENG]	Program language specifications, MX Controller instructions, standard functions/function blocks, and specifications of motion control function blocks

When using a safety CPU module, refer to the following:

 MELSEC iQ-R CPU Module User's Manual (Application)



TERMS

Unless otherwise specified, this manual uses the following terms.

Term	Description
Backup mode	A mode to continue operation in a redundant system. This mode can continue the operation by switching the systems from the control system to the standby system when an error occurs in the control system.
Process CPU (redundant mode)	A Process CPU operating in redundant mode. A redundant system is configured with this CPU module. Process control function blocks and the online module change function can be used even in this mode.

GENERIC TERMS AND ABBREVIATIONS



Unless otherwise specified, this manual uses the following generic terms and abbreviations.

Generic term/abbreviation	Description
CPU module* ¹	MXR300-16, MXR300-32, MXR300-64, MXR500-128, MXR500-256, MXF100-8-N32, MXF100-8-P32, MXF100-16-N32, MXF100-16-P32, R01CPU, R02CPU, R04CPU, R04ENCPU, R08CPU, R08ENCPU, R08PCPU, R08SFPCPU, R16CPU, R16ENCPU, R16PCPU, R16SFPCPU, R32CPU, R32ENCPU, R32PCPU, R32SFPCPU, R120CPU, R120ENCPU, R120PCPU, R120SFPCPU
MX Controller	A MELSEC MX Controller (MX-R model, MX-F model)
MX-R model	MXR300-16, MXR300-32, MXR300-64, MXR500-128, MXR500-256
MX-F model	MXF100-8-N32, MXF100-8-P32, MXF100-16-N32, MXF100-16-P32
RCPU	RnCPU, RnENCPU, process CPU, safety CPU
RnCPU	R01CPU, R02CPU, R04CPU, R08CPU, R16CPU, R32CPU, R120CPU
RnENCPU	R04ENCPU, R08ENCPU, R16ENCPU, R32ENCPU, R120ENCPU
RnENCPU (CPU part)	A module on the left-hand side of the RnENCPU ( MELSEC iQ-R Ethernet/CC-Link IE User's Manual (Startup))
RnENCPU (network part)	A module on the right-hand side of the RnENCPU ( MELSEC iQ-R Ethernet/CC-Link IE User's Manual (Startup))
Process CPU	R08PCPU, R16PCPU, R32PCPU, R120PCPU
Safety CPU	R08SFPCPU, R16SFPCPU, R32SFPCPU, R120SFPCPU. A module that performs both standard control and safety control and is used with a safety function module.

*1 In this manual, 'MX Controller' is also described as 'CPU module.'

1 OVERVIEW

CPU Module Logging Configuration Tool is a tool to use the data logging function of a CPU module.

- Configure the data logging settings such as the logging type, sampling interval, sampling condition, and target data by following the wizard screen.
When transferring data logging files to the FTP server, configure the data logging setting. ( Page 25 DATA LOGGING SETTING)
- To start the data logging automatically, configure the auto logging common setting. ( Page 58 Auto Logging Common Setting)
- The data logging can be started or stopped, and a sampled data logging file can be obtained or deleted.

This manual explains the operation methods for the MELSEC MX Controllers/MELSEC iQ-R series.

For the operation methods for the MELSEC iQ-F/MELSEC-Q/MELSEC-L series, refer to the following:

 MELSEC iQ-F FX5 User's Manual (Application)

 QnUDVCPU/LCPU User's Manual (Data Logging Function)

For the menu configuration of CPU Module Logging Configuration Tool, refer to the following:

 Page 20 Menu Configuration

2 SYSTEM CONFIGURATION

This chapter explains the operating environment and the communication route of CPU Module Logging Configuration Tool.

2.1 Operating Environment

For details on the operating environment for CPU Module Logging Configuration Tool, refer to following manual which is stored in the installer.

 CPU Module Logging Configuration Tool/GX LogViewer Installation Instructions (BCN-P5999-0506)

The above manual is stored in the "Manual" folder which is stored in the same folder as the installer.

2.2 Communication Routes

The communication routes between a personal computer and a CPU module are as follows:

CPU module	Communication route	Reference	
MX Controller	Connection to a CPU module from a personal computer	USB connection	Page 11 USB connection
		Ethernet connection	Page 12 Ethernet connection
RCPU	Connection to a CPU module from a personal computer	USB connection	Page 11 USB connection
		Ethernet connection	Page 12 Ethernet connection
	Connection to a CPU module via a GOT		Page 15 Connection to a CPU module via a GOT

Connection to a CPU module from a personal computer

USB connection

Connect a personal computer and a CPU module through USB ports with a USB cable.

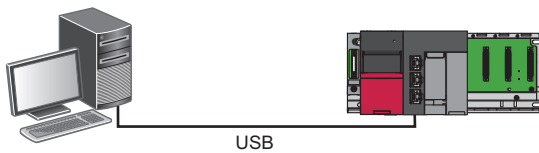

Use a USB cable. The following types of USB cables can be used:

■MX Controller

- USB cable (USB A type — USB C type)
- USB cable (USB C type — USB C type)

■RCPU

- USB cable (USB A type — USB miniB type)
- USB cable (USB B type — USB miniB type)

Restriction

Only one CPU module can be connected to a personal computer at the same time. The following connection configurations are prohibited.

- Connection to multiple CPU modules from a personal computer with multiple USB ports

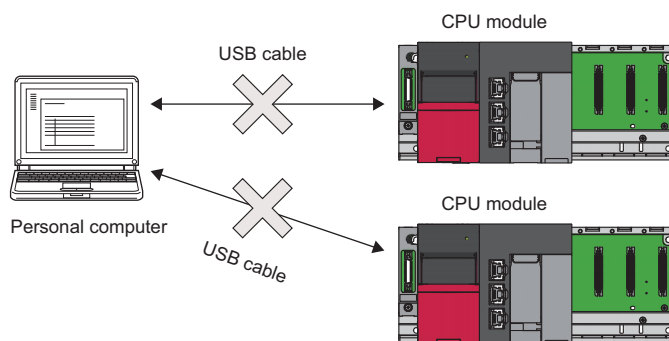

- Connection to multiple CPU modules via a USB hub

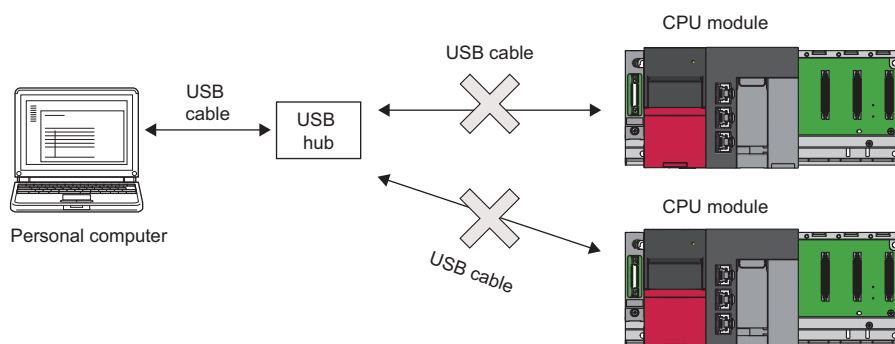

■Consideration for connection to a process CPU (redundant mode)

To connect to a process CPU (redundant mode), select the checkbox of "Connect to RnPCPU (Redundant Mode)" and select a target connection system for "Transfer Setup System" in the "Transfer Setup" screen. (Page 61 Transfer setup (RCPU))

Ethernet connection

■ Direct connection

A CPU module can be directly connected to a personal computer on a 1:1 basis with an Ethernet cable (crossover cable) without a hub.

Note that specifying the IP address of the CPU module is not required. (Broadcast is used.)

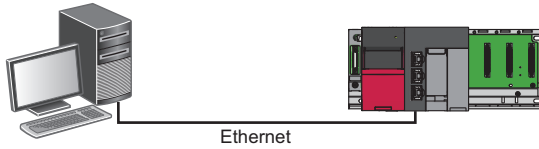

■ Connection via a hub

Connect a CPU module via a hub to a personal computer on the same local network.

Note that the IP address or host name of the CPU module needs to be specified. In addition, set the same network address as the CPU module in the network settings of the personal computer.

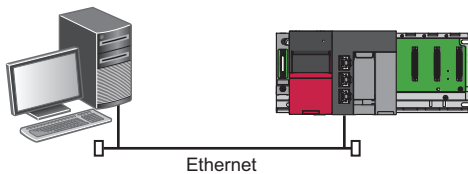

Connection can be established with a LAN cable only. Connection via the Internet is not available.

■ Considerations for Ethernet connection

- Do not directly connect to a personal computer via LAN line. Load imposed on the LAN line adversely affects communications by other devices.
- Do not configure the direct connection settings when connecting a CPU module to a personal computer via a hub on a 1:1 basis.
- If the following conditions are satisfied, communication by direct connection may not be available. In that case, review the settings of the module and the personal computer.

Ex.

When all the bits of the CPU module-side IP address corresponding to the '0' parts of the personal computer-side subnet mask are ON or OFF

CPU module-side IP address: 64.64.255.255

Personal computer-side IP address: 64.64.1.1

Personal computer-side subnet mask: 255.255.0.0

Ex.

When all the bits of the CPU module-side IP address corresponding to the host address of each class of the personal computer-side IP address are ON or OFF^{*1*2}

CPU module-side IP address: 64.64.255.255

Personal computer-side IP address: 192.168.0.1

Personal computer-side subnet mask: 255.255.0.0

*1 The IP address for each class is as follows:

- Class A: 0.x.x.x to 127.x.x.x
- Class B: 128.x.x.x to 191.x.x.x
- Class C: 192.x.x.x to 223.x.x.x

*2 The host address for each class is 0 part in the following addresses:







- Class A: 255.0.0.0
- Class B: 255.255.0.0
- Class C: 255.255.255.0

Ex.

When the CPU module-side IP address is automatically obtained through DHCP

- Disable Windows[®] firewall setting, if enabled.
- Do not configure the direct connection settings in a configuration in which multiple IP addresses are enabled at the same time as shown below.
 - An IP address is assigned to each Ethernet port (network device) of a personal computer with multiple Ethernet ports.
 - A wireless LAN setting is enabled in addition to an Ethernet port of a personal computer.
 - Multiple IP addresses are assigned to a single Ethernet port of a personal computer.

■ Consideration for Ethernet connection of an MX Controller

- For details on the connectable ports of an MX Controller, refer to the following:
 - ( MELSEC MX Controller (MX-R Model) User's Manual)
 - ( MELSEC MX Controller (MX-F Model) User's Manual)
- If connecting a personal computer and an MX Controller across the trust border, encrypted communication is recommended.
- To perform encrypted communication, select a protocol of encrypted communication ("TLS" or "DTLS") in the "Transfer Setup" screen.
 - ( Page 60 Transfer setup (MX Controller))
- To perform encrypted communication, it is recommended to enable user authentication of an MX Controller in advance. User authentication can be enabled in GX Works3.
 - For details, refer to the following:
 - ( GX Works3 Operating Manual)
 - In addition, an electronic certificate is required for encrypted communication.
 - For details, refer to the following:
 - ( MELSEC MX Controller (MX-R Model) User's Manual)
 - ( MELSEC MX Controller (MX-F Model) User's Manual)

■ Consideration for Ethernet connection of an RCPU

- For RnENCPU, use the Ethernet port of the RnENCPU (CPU part) to connect to the personal computer. An Ethernet port of an RnENCPU (network part) cannot be used for this connection.
- To connect to a process CPU (redundant mode), select the checkbox of "Connect to RnPCPU (Redundant Mode)" and select a target connection system for "Transfer Setup System" in the "Transfer Setup" screen. ( Page 61 Transfer setup (RCPU))

Connection to a CPU module via a GOT

The following shows the connection to a CPU module from a personal computer via a GOT by using the GOT transparent function.

MX Controllers do not support this connection.

- Supported GOTs: GOT2000 series (except for models without Ethernet ports)
- Supported connection methods: USB, Ethernet



The connection availability and the specification method of connection destination differ depending on the connection condition between a personal computer and a GOT.

For details, refer to the following:

📖 GOT2000 Series Connection Manual (Mitsubishi Products) For GT Works3 Version1

Precautions

■When performing online operations from a personal computer

During the online operation from a personal computer to a CPU module using the GOT transparent function, do not perform online operations (such as downloading project data) on a GOT from GT Designer3.

■When GOT does not monitor normally

The GOT transparent function cannot be used in the following cases.

- When a GOT does not perform normal monitoring due to CPU module errors or communication errors between the CPU module and the GOT
- During the period of time between turning ON or resetting the CPU module or GOT and the start of GOT monitoring

Check the following items if monitoring on GOT is not normal.

Item	Reference
Does the CPU module operates normally?	📖 GX Works3 Operating Manual
Is the CPU module connected to GOT normally?	📖 Manual of GOT used

■Connection to a process CPU (redundant mode)

To connect to a process CPU (redundant mode), select the checkbox of "Connect to RnPCPU (Redundant Mode)" and select a target connection system for "Transfer Setup System" in the "Transfer Setup" screen. (📖 Page 61 Transfer setup (RCPU))

3 OBTAINING AND START of CPU Module Logging Configuration Tool

3.1 How to Obtain

In Japan

CPU Module Logging Configuration Tool can be downloaded from the Mitsubishi Electric FA website.

www.MitsubishiElectric.co.jp/fa

For downloading CPU Module Logging Configuration Tool, please register for a free membership on the Mitsubishi Electric FA website in advance.

In other countries

For the information on how to obtain CPU Module Logging Configuration Tool, please contact your local Mitsubishi Electric sales office or representative.

3.2 Installation and Uninstallation

For the installation/uninstallation procedure of CPU Module Logging Configuration Tool, refer to the following:

 CPU Module Logging Configuration Tool/GX LogViewer Installation Instructions (BCN-P5999-0506)

The above manual is stored in the "Manual" folder which is stored in the same folder as the installer.

3.3 Start and End

This section explains the operation methods for starting and ending CPU Module Logging Configuration Tool.

Start

The following shows the methods to start CPU Module Logging Configuration Tool.

If an error message appears when starting CPU Module Logging Configuration Tool due to an insufficient access authority, start this tool with the administrator authority.

■ Starting from the Windows Start menu

Start CPU Module Logging Configuration Tool from "MELSOFT" in Windows Start.

■ Starting from GX Works3

Start CPU Module Logging Configuration Tool from GX Works3.

When registering devices/labels in the "Data" setting screen of CPU Module Logging Configuration Tool automatically, start the operation from step 1. When not registering them automatically, start from step 2.

1. Select a device/label in a program editor^{*1} or in a watch window in GX Works3.

At this time, select a device/label to be registered in CPU Module Logging Configuration Tool.

2. Perform either of the following operations in GX Works3:

- Select [Tool] ⇒ [Logging Configuration Tool].
- Right-click it and select [Set to Logging Target (Logging Configuration Tool)] from the shortcut menu.

*1 CPU Module Logging Configuration Tool cannot be started from an SFC diagram editor.

Point

When starting CPU Module Logging Configuration Tool from GX Works3, the following information is applied from GX Works3:

- Module type information of a project
- Current connection destination of a project
- Display language

When starting the operation from step 1, the following information is also applied:

- Devices/labels (Registered in the "Data" setting screen automatically.)
- GX Works3 project (It is read automatically.)

Precautions

• To register devices/labels automatically, check the supported version of GX Works3 and CPU Module Logging Configuration Tool.

☞ Page 75 Version Compatibility

- Devices/labels used in a project for a process CPU are not registered automatically.
- Devices/labels whose data type is "--" in a watch window in GX Works3 and devices/labels that cannot be registered in a watch window are not registered automatically.

■ Starting from GX LogViewer

Refer to the following:

📖 GX LogViewer Version 1 Operating Manual

End

Operating procedure

Select [Project] ⇒ [Exit].

3.4 Display Language Switching

CPU Module Logging Configuration Tool supports multiple languages, and therefore the display language such as one on the menu can be switched on a personal computer.*1

*1 For CPU Module Logging Configuration Tool with the version "1.46Y" or later

Operating procedure

Select [View] ⇒ [Switch Display Language].

Precautions

If the display language differs from the one for the operating system, displayed texts may get cut.

4 SCREEN CONFIGURATION

4.1 Main Window

This section explains the screen configuration when starting CPU Module Logging Configuration Tool.

Ex.

MX-R model

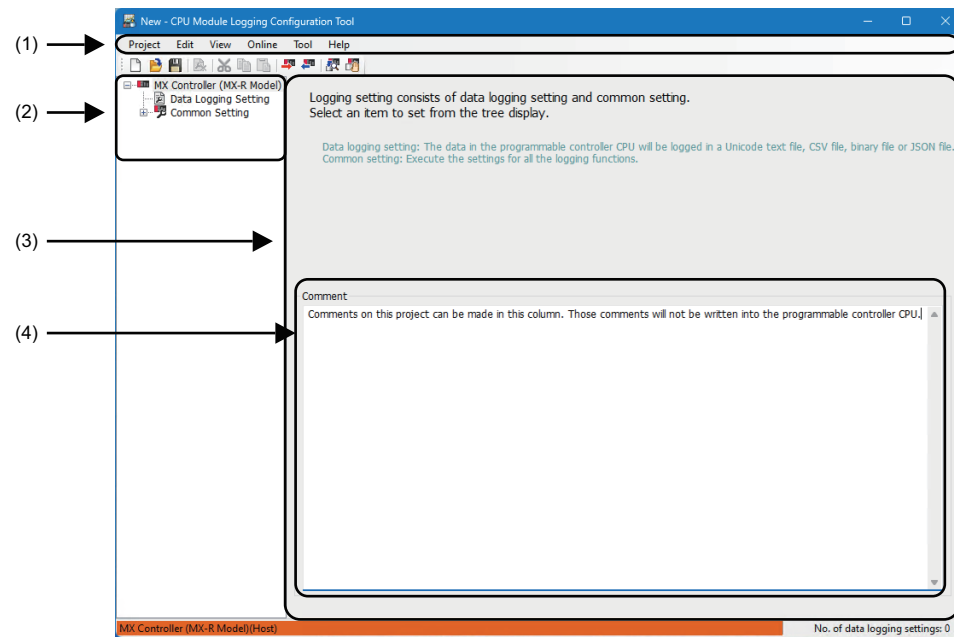

Displayed items

Item	Description	Reference
(1) Menu bar	Menu items for performing each function are displayed.	Page 20 Menu Configuration
(2) Edit item tree	The overall project settings are displayed in a tree. The setting screen is displayed in (3) by selecting a tree item.	Page 25 DATA LOGGING SETTING Page 58 COMMON SETTING
(3) Setting screen	The setting screen for each item is displayed by selecting a tree item in the edit item tree.	—
(4) Comment	When "MX Controller (MX-F Model)," "MX Controller (MX-R model)," or "RCPU" is selected in the edit item tree, the setting screen for a comment is displayed. A comment for a project can be set. This is not written to a CPU module.	—

4.2 Menu Configuration

The following table shows the menu configuration of CPU Module Logging Configuration Tool.

Menu item		Description
Project	New	To create a new project
	Open	To open a saved project file
	Save	To save an edited project to a file
	Save As	To save an edited project under a new file name
	Read Logging Setting from Memory Card(SD)	To read a data logging setting written in an SD memory card inserted in a personal computer
	Write Logging Setting into Memory Card(SD)	To write a setting being edited in a format with which a CPU module can operate. Once the setting is directly written into an SD memory card inserted in a personal computer and then the SD memory card is mounted onto the CPU module, the data logging starts.
	Recent Files	To open a file used recently
	Read GX Works3 Project	To read a GX Works3 project which is the read source for the label
	Exit	To end CPU Module Logging Configuration Tool
Edit	Delete Data Logging Setting	To delete a data logging setting selected in the edit item tree
	Copy and Add Data Logging Setting	To copy and add a data logging setting selected in the edit item tree
	Batch Data Insertion	To configure multiple setting items in a batch
	Cut Setting Item	To delete data in a selected row and copy the setting item to the clipboard ^{*1}
	Copy Setting Item	To copy the setting item in a selected row to the clipboard ^{*1}
	Paste Setting Item	To paste a copied setting item into a selected row ^{*2}
	Paste device/label copied in other application software	To overwrite a device or label which is copied in another application in a selected row. (Existing data in the selected row is deleted.)
	Insert and Paste Setting Item	To insert a setting item in the clipboard above the selected row by executing "Insert and Paste Setting Item" while the setting item is copied or cut. ^{*2}
	Insert device/label copied in other application software	To paste a device or label which is copied in another application into a selected row, and shift down existing data in the selected row and below
	Delete Setting Item	To delete a setting item in a selected row
	Move Setting Item Upward	To move up a setting item in a selected row
	Move Setting Item Downward	To move down a setting item in a selected row
	Device Batch Replacement	To replace devices for all settings
View	Switch Display Language	To switch the display language for menus, etc
Online	Transfer Setup	To configure the communication setting used when connecting to a CPU module
	Read Logging Setting	To read a setting from a CPU module
	Write Logging Setting	To write a setting to a CPU module
	Delete Logging Setting	To delete setting data from a CPU module
	Logging Status and Operation	To check the data logging status
	Logging File Operation	To connect to a CPU module and read or delete files in an SD memory card inserted or data memory
	Data Logging File Transfer Status ^{*3}	To display the transfer status of a data logging file
Tool	Start GX LogViewer	To start GX LogViewer
Help	Open Manual	To start e-Manual Viewer and display the manual
	Connection to MITSUBISHI ELECTRIC FA Global Website	To display the Mitsubishi Electric FA website
	About Configuration tool	To display the product information

*1 Once the setting item is copied or cut, the copied state will not be canceled even when the setting item is edited or the screen is transitioned. Pasting is available as long as the copied data exists in the clipboard.

*2 A setting item which is copied in another application (such as a watch window of GX Works3 or GX Works2, a spreadsheet, and a text editor) can also be pasted.

*3 MX Controllers do not support it.

5 PROJECT MANAGEMENT

This chapter shows the operations to create and save a project, and read from or write to an SD memory card.

5.1 Creating a New Project

Create a new project.

Window

Select [Project] ⇒ [New].

Ex.

MX-R model

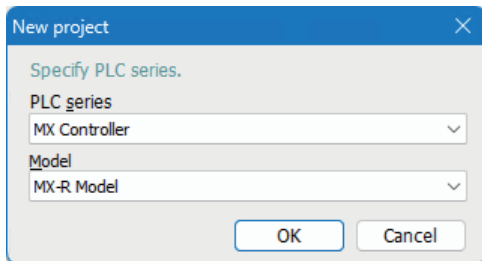

Operating procedure

Select a target model for "PLC series" and "Model"*1, and click the [OK] button.

*1 For RCPUs, "Model" is not displayed.

5.2 Opening a Project

Open a stored project file.

Operating procedure

Select [Project] ⇒ [Open].

5.3 Saving a Project

Overwriting

Save an edited project to a file.

Operating procedure

Select [Project] ⇒ [Save].

Saving under a new file name

Save an edited project under a new file name.

Operating procedure

Select [Project] ⇒ [Save As].

5.4 Reading Logging Settings from an SD Memory Card

The following screen is used to read the data logging setting written in an SD memory card inserted in a personal computer. Insert the SD memory card in the personal computer in advance.

Window

Select [Project] ⇒ [Read Logging Setting from Memory Card(SD)].

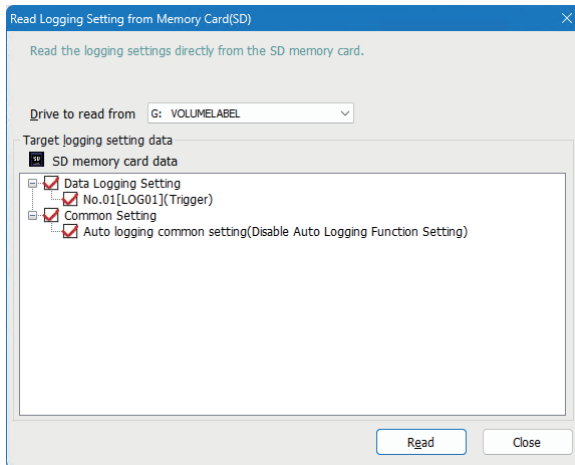

Operating procedure

1. Select the drive in which the data to be read is stored for "Drive to read from."
2. Select the checkbox of the data to be read.
3. Click the [Read] button.

Point

- Any existing data (data logging setting with the same setting number or common setting) on the target is overwritten.
- The PLC series of a project opened in CPU Module Logging Configuration Tool need to match with the one of the setting data in an SD memory card.

5.5 Writing Logging Settings into an SD Memory Card

The following screen is used to write the settings being edited in a format with which the CPU module can operate. Once the settings are directly written to an SD memory card inserted in a personal computer and then the SD memory card is inserted in the CPU module, the data logging starts. (Auto logging)

For details on the auto logging function of a CPU module, refer to "Auto Logging" in the manual for the CPU module used.

RELEVANT MANUALS

Insert the SD memory card in the personal computer in advance.

Window

Select [Project] ⇒ [Write Logging Setting into Memory Card(SD)].

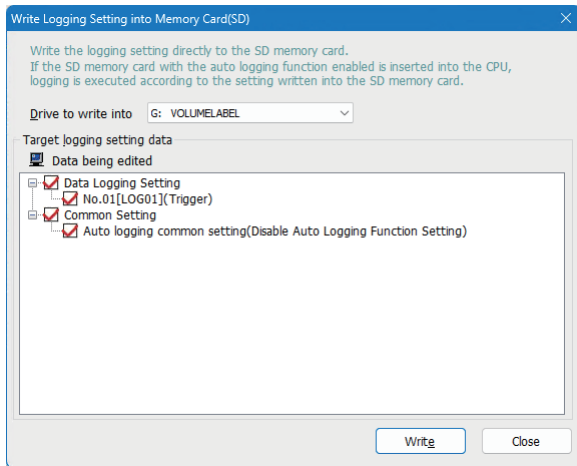

Operating procedure

1. Select the drive in which the data to be written is stored for "Drive to write into."
2. Select the checkbox of the data to be written.
3. Click the [Write] button.

Point

Any existing data (data logging setting with the same setting number or common setting) on the target is overwritten.

5.6 Reading a GX Works3 Project

The following screen is used to read a GX Works3 project which is the read source for the label.

Window

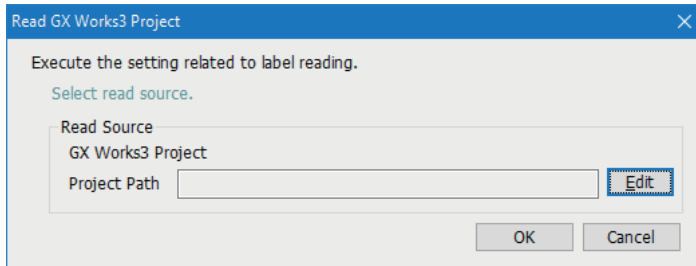

Select [Project] ⇨ [Read GX Works3 Project].



Operating procedure

1. Click the [Edit] button, and select a project which is the read source.
The full path of the read source project is displayed in "Project Path." When no project is read, this field is blank.
2. Click the [OK] button.

Precautions

- When reading a GX Works3 project whose security version is '2,' the "Project Authentication" screen appears.
The password registered to the project needs to be entered to log on.
For details on the security version, refer to the following:
 GX Works3 Operating Manual
- When reading a GX Works3 project with enabled user authentication, the "User Authentication (Project)" screen appears.
The user name and password registered to the project need to be entered to log on.
Note that for a project for an RnSFCPU, when a guest user is enabled, the screen does not appear and the project is logged on as the guest user.
User authentication can be enabled in GX Works3.
For details, refer to the following:
 GX Works3 Operating Manual

6 DATA LOGGING SETTING

This chapter shows the operations to configure the required settings in the wizard format for using the data logging function of a CPU module.

For details on the data logging function of a CPU module, refer to "DATA LOGGING FUNCTION" in the manual for the CPU module used.

📖 RELEVANT MANUALS

6.1 Data Logging Setting for MX Controllers

This section shows the setting method of data logging of MX Controllers.

Logging setting list screen

In the logging setting list screen, data logging settings are displayed in a list.

Window

Select "MX Controller (MX-R Model)" or "MX Controller (MX-F Model)" ⇒ "Data Logging Setting" in the edit item tree.

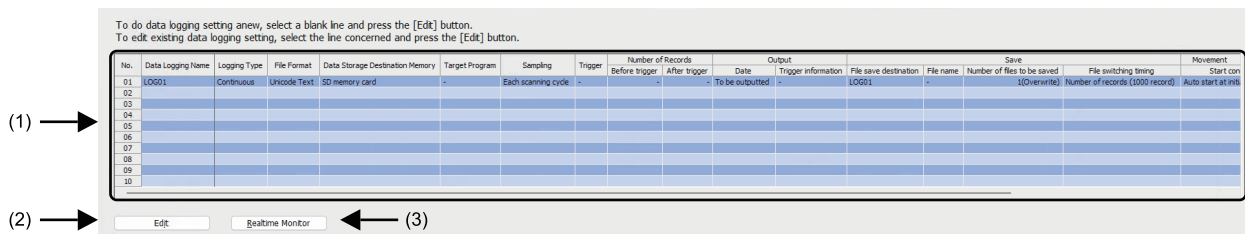

Displayed items

Item	Description
(1) Logging setting list	— The data logging settings are displayed in a list. (Up to 10 settings)
	No. The data logging setting number is displayed. (No. 01 to 10)
	Data Logging Name The name of a set data logging is displayed.
	Setting contents The setting contents of a data logging setting are displayed.
(2) [Edit] button	Click this to display the wizard screen to configure the data logging settings. When a blank row is selected, a new data logging setting can be created. When a data logging setting is selected, the setting can be edited.
(3) [Realtime Monitor] button	Click this to display the "Realtime Monitor Setting" screen of GX LogViewer. The data logging settings of the selected row are automatically applied to the "Realtime Monitor Setting" screen. For details on the "Realtime Monitor Setting" screen, refer to the following: GX LogViewer Version 1 Operating Manual

Logging type setting

The following screen is used to set the following items of the data logging: type, target data, file format, and storage destination of a data logging file.

For details on the data logging types and data logging files, refer to the manual for the MX Controller used.

☞ RELEVANT MANUALS

Window

Click the [Edit] button in the logging setting list screen.

First off, select a logging type.

Logging type Select a logging type. <input checked="" type="radio"/> Continuous logging Logging is carried out continuously at the specified time interval. Interval at which or conditions under which to carry out logging can also be specified. <input type="radio"/> Trigger logging By monitoring data, data before and after a condition held true is logged.	Logging target Target program name <input type="text"/> Specify the program name that includes a label when the local label is used. Specify the program name included in read project by [Project] menu -> [Read GX Works3 Project].
Data storage destination memory Select logging file storage destination memory. <input checked="" type="radio"/> SD memory card Save sampled data to SD memory card that is portable storage media. <input type="radio"/> Function memory Save sampled data to function memory of CPU built-in memory. The file in the function memory is deleted when the CPU is reset. <input type="radio"/> Data memory After saving sampled data to function memory of CPU built-in memory, it will be transferred to data memory after completing or stopping logging.	File format Select the file format which outputs the logging. <input checked="" type="radio"/> Unicode text file The data can be checked not only by GX LogViewer but also by text editor or table calculation soft. <input type="radio"/> CSV file (Shift-JIS) The data can be checked not only by GX LogViewer but also by text editor or table calculation soft. <input type="radio"/> CSV file (UNICODE) The data can be checked not only by GX LogViewer but also by text editor or table calculation soft. <input type="radio"/> Binary file The data in the file can be checked by GX LogViewer. Compare with CSV file, the file volume can be decreased. <input type="radio"/> JSON file The data can be checked not only by GX LogViewer but also by text editor.

Displayed items

Item	Description
Logging type	Select a logging type.
Logging target	Target program name Enter the target program name to specify a local label in a program block.
Data storage destination memory	Select the storage destination of a data logging file.
File format	Select an output file format.

Sampling

The following screen is used to configure the sampling interval and sampling start conditions. For details on the conditions to sample data, refer to the manual for the MX Controller used.

📖 RELEVANT MANUALS

Window

Specify the sampling interval and start conditions.

Sampling interval

- Each scanning cycle
Samples data at each sequence scanning cycle.
- Time specification
Samples data at the specified time interval.
 Sample data at the next END processing after the specified time has elapsed(W)
- Condition specification
Specifies data sampling timing by data conditions.

<input type="text"/>	<input type="text"/>	<input type="text"/>	<input type="text"/>
Device/Label	Conditional formula	Data/Constant	Data name/Constant
<input type="text"/>	<input type="text"/>	<input type="text"/>	<input type="text"/>
Data type(K)			
<input type="text"/>			
- Network communication period synchronization
Samples data at the specified cycle interval.
- After executing specified program
Samples data after executing the specified program.
Program name

Displayed items

Item		Description
Each scanning cycle		Select this to sample data at the END processing on every scan.
Time specification	—	Select this to sample data at the specified time interval.
	Sampling time value	Specify a sampling interval value.
	Sample data at the next END processing after the specified time has elapsed	Select the checkbox to sample data at the timing of the next END processing after the specified time has elapsed. The selection status cannot be changed.
Condition specification	—	Select this to sample data when the target data meets the specified condition.
	Device/label specification	Select the data to set a condition.
	Device/Label ^{*1*2*3*4}	For "Device specification," enter the device name. For "Label specification," enter the label name.
	Data type ^{*5}	Select a data type when a device is specified as the target data. When a label is specified as the target data, a data type is displayed according to the data type of the label.
	Conditional formula	Select a condition formula.
	Data/Constant	Select the data to be set as a comparison target.
	Data name/Constant ^{*1*2}	Enter a data name or constant to be set as a comparison target.
Network communication period synchronization ^{*6}	—	Select this to sample data at the interval which is synchronized with the specified network communication cycle.
	Synchronization interval	Select a sampling interval.
After executing specified program	—	Select this to sample data after executing the specified program.
	Program name	Set a name of a program to be specified.

- *1 If a GX Works3 project has been read, up to 100 options are displayed when entering a label name. (📖 Page 24 Reading a GX Works3 Project)
- *2 Labels which include a special character (such as an umlaut character) may not be specified.
- *3 When the target data is a label, only labels whose name is less than 256 characters can be specified.
- *4 When the target data is a local label of a function block, a sampled data is an indefinite value. Therefore, do not specify a local label of a function block.
- *5 When the target data is a timer type device and counter type device, its data type is set as follows. These data types cannot be changed.
 - T, ST, C: Word [unsigned]
 - LT, LST, LC: Double word [unsigned]
- *6 For details on "Network Communication Period Synchronization", refer to the following:
 - 📖 MELSEC MX Controller (MX-R Model) User's Manual
 - 📖 MELSEC MX Controller (MX-F Model) User's Manual

Data

The following screen is used to set the target data to be sampled.

For details on the target data and output formats, refer to the manual for the MX Controller used.

☞ RELEVANT MANUALS

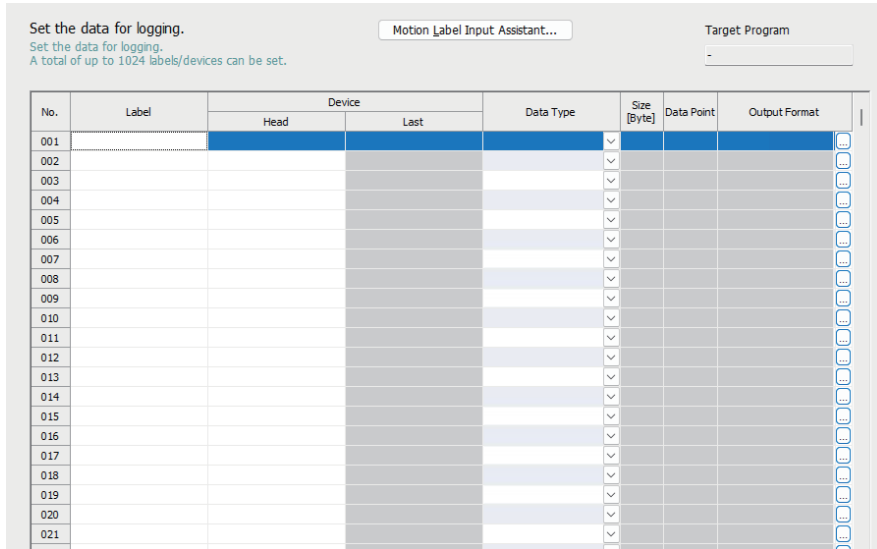

Window





Displayed items

Item	Description	
[Motion Label Input Assistant] button ¹	Click this to display the "Motion Label Input Assistant" screen. (☞ Page 31 Motion label input assistant) A variable (label) which is to be used for the motion control can be registered in a selected row.	
No.	The data setting numbers from 001 to 1024 are displayed.	
Label	Set a target label. *2*3*4*5*6*7*8*9 <ul style="list-style-type: none"> ■When setting a global label Enter "Label name." Example: "label_w1" For the label of timer type/retentive timer type/counter type, specify the element name. (S: contact, C: coil, N: current value) Example: "label_w1.S" ■When setting a local label Enter "Program block name/Label name." Example: "ProgPou/label_w1" For the label of timer type/retentive timer type/counter type, specify the element name. (S: contact, C: coil, N: current value) Example: "ProgPou/label_w1.S" ■When setting a structure element Enter "Label.Element name." For the label of timer type/retentive timer type/counter type, specify the element name. (S: contact, C: coil, N: current value) Example: "tmLabel.S" ■When setting an array element Enter "Label name[Element number of third dimension][Element number of second dimension][Element number of first dimension]."*10*11 ■When setting a structure array member Enter "Label name[Element number of third dimension][Element number of second dimension][Element number of first dimension].Member name."*10*11 	
Device	Head	Set the start device number. *9 To specify a local device, use "Program name/#Device name." (Example: "MAIN/#M1")
	Last	The end device number calculated based on the data type and size is displayed.
Data Type	When the target data is a label, a data type is displayed according to the data type of the label. When the target data is a device, select a data type.	
Size [Byte]	When the target data is a label, a size is displayed for "String" data type. When the target data is a device, specify a data size for "String" or "Raw" data type.	
Data Point	The number of data points of the data type is displayed.	

Item	Description
Output Format ^{*12*13}	Click the [...] button at the rightmost part to display the "Output Format (integer/float)" screen for each row. Select the format to be used when data is output to the file.
Target Program	This is displayed when "Target program name" is set in the "Logging type" setting screen.

- *1 Enabled only when a GX Works3 project has been read. ( Page 24 Reading a GX Works3 Project)
- *2 When the entered label name is valid, it is used as it is. Therefore, the case may differ between the label name defined in GX Works3 and the label name displayed in the screen.
- *3 The labels that cannot be watched in GX Works3 are not available.
- *4 If a GX Works3 project has been read, up to 100 options are displayed when entering a label name. ( Page 24 Reading a GX Works3 Project)
- *5 Labels which include a special character (such as an umlaut character) may not be specified.
- *6 Only labels whose name is less than 256 characters can be specified.
- *7 When the target data is a string [Unicode] type label, only labels whose data length is less than 128 characters can be specified.
- *8 When the target data is a local label of a function block, a sampled data is an indefinite value. Therefore, do not specify a local label of a function block.
- *9 To sample target data of the data flow analysis function (AI analysis) of GX Works3 by using the data logging function, specify the analysis target devices/labels.
- *10 If an array element is not specified, it is handled as the start of the array ([0]). (Example: When "bLabel1[0..9]" exists and "bLabel1" is entered, it is handled as "bLabel1[0].")
- *11 If the entered array is out of the range, an undefined value is specified.
- *12 When the data type of the target data is "Bit," "String," "Row," or "Time," the output format cannot be changed.
- *13 When "JSON file" is selected for "File format" in the "Logging type" setting screen, the output format cannot be set.

Point

- To register a variable (label) which is to be used for the motion control, use "Motion Label Input Assistant." ( Page 31 Motion label input assistant)
- To paste a device/label which is copied in another application (such as a watch window of GX Works3 or GX Works2, a spreadsheet, or a text editor), use "Paste device/label copied in other application software" or "Insert device/label copied in other application software." ( Page 48 Pasting/inserting a device or label copied in another application).
- To insert data into the data list in a batch, use "Batch Data Insertion." ( Page 49 Inserting data in a batch)

Motion label input assistant

The following screen is used to register a variable (label), which is to be used for the motion control, in the row selected in the "Data" setting screen.

For details on the variables (labels) which are used for the motion control, refer to the following:

MELSEC MX Controller (MX-R Model) Programming Manual

MELSEC MX Controller (MX-F Model) Programming Manual

Window

Click the [Motion Label Input Assistant] button in the "Data" setting screen.

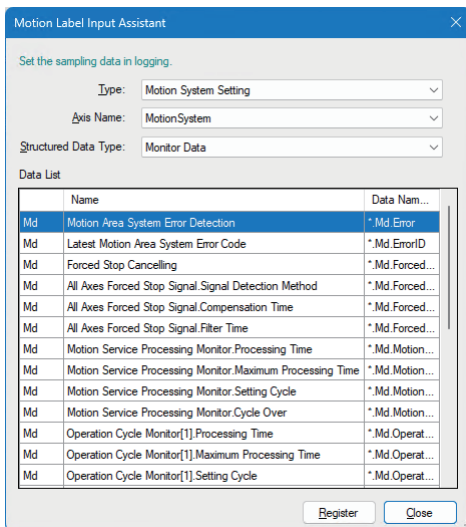

Operating procedure

1. Set each item.

Item	Description
Type	Select a type of a variable (label) which is to be used for the motion control.
Axis Name	Select any of the following items according to the item selected for "Type." <ul style="list-style-type: none"> When "Motion System Setting" is selected: MotionSystem When an axis is selected: Axis name When "Axes Group" is selected: Axes group name
Structured Data Type	Select a type of a member of the structure. The contents in "Data List" is filtered by the character strings in the first column according to the selected item. <ul style="list-style-type: none"> When "Monitor Data" is selected: Md When "Command Data" is selected: Cd

2. Select a variable (label) to be used for the motion control, which is displayed in "Data List," and click the [Register] button.

Point

By registering a variable (label) to be used for the motion control from the "Motion Label Input Assistant" screen, 'unit information' is added to the data name in a data logging file.

Note that 'unit information' is added only when the registered variable (label) has a unit.

For details on the motion units, refer to the following:

MELSEC MX Controller (MX-R Model) User's Manual

MELSEC MX Controller (MX-F Model) User's Manual

Pasting/inserting a device or label copied in another application

A device or label which is copied in another application (such as a watch window of GX Works3 or GX Works2, a spreadsheet, or a text editor) can be pasted into a selected row in the "Data" setting screen.

The method is the same as that of RCPUs.

For details, refer to the following:

 Page 48 Pasting/inserting a device or label copied in another application

Inserting data in a batch

Data can be inserted into the data list in a batch.

The method is the same as that of RCPUs.

For details, refer to the following:

 Page 49 Inserting data in a batch

Trigger

The following screen is used to specify the trigger condition when the trigger logging is selected. For details on the trigger logging, refer to the manual for the MX Controller used.

 RELEVANT MANUALS

Window

Make trigger setting.

Trigger Condition

Joint Condition(M) OR Joint Trigger occurs by meeting any of conditions which was set.

Condition List

Monitoring Data Points: 5 /32 Points Edt... Delete Delete All

No.	Type	Content
001	Condition Specification (Comparison)	D0 = D1
002	Event Occurrence	H09090
003	Condition Specification (Difference)	R00
004	Condition Specification (Rising)	M0
005	Fixed Scan	100
006		
007		
008		

Trigger Count

Count Specification (1 - 32767)
Repeat the specified count, trigger logging.
The operation will be "Overwrite" when it exceeds the upper bound of saved file count.

Saved File Count Specification
Repeat trigger logging according to the upper bound setting of saved file count.

Displayed items

Item	Description		
Trigger Condition	Joint Condition	Select either of the following joint conditions: <ul style="list-style-type: none"> • OR Joint: A trigger occurs when any of the set conditions is satisfied. • AND Joint: A trigger occurs when all the set conditions are satisfied. 	
	Condition List	Monitoring Data Points	The number of points of the data to be monitored is displayed.
		[Edit] button	Click this to display the editing screen for a trigger condition. ( Page 34 Editing a trigger condition)
		[Delete] button	Click this to delete a trigger condition of the selected row.
		[Delete All] button	Click this to delete all trigger conditions.
	No.	Trigger conditions set in the editing screen for a trigger condition are displayed. (Up to 32 conditions)	
Type	The type of a trigger condition set in the editing screen for a trigger condition is displayed. <ul style="list-style-type: none"> ■When condition specification (data type is bit) is specified <ul style="list-style-type: none"> • Condition Specification (Rising) • Condition Specification (Falling) ■When condition specification (data type is other than bit) is specified <ul style="list-style-type: none"> • Condition Specification (Comparison) • Condition Specification (Difference) ■When fixed scan is specified <ul style="list-style-type: none"> • Fixed Scan ■When event occurrence is specified <ul style="list-style-type: none"> • Event Occurrence 		
Content	The content set in the editing screen for a trigger condition is displayed. <ul style="list-style-type: none"> ■When condition specification is specified <ul style="list-style-type: none"> • Target data name • Conditional formula ■When fixed scan is specified <ul style="list-style-type: none"> • Specified cycle (ms) ■When event occurrence is specified <ul style="list-style-type: none"> • Event code • Error code 		

Item		Description
Trigger Count	Count Specification	Select this to restrict the number of executions of trigger logging. Enter the number of trigger loggings to be repeated in the text box. When the number of logging files exceeds the setting value in "Number of files to be saved" in the "Save" setting screen, a logging file is overwritten. (Page 39 Save)
	Saved File Count Specification	Select this to execute a trigger logging repeatedly without restricting the number of execution of trigger logging. When the number of logging files exceeds the setting value in "Number of files to be saved" in the "Save" setting screen, a logging file is overwritten. (Page 39 Save)

Editing a trigger condition

The following screen is used to set a trigger occurrence condition.

Window

Select "Joint Condition" in the "Trigger" setting screen, and click the [Edit] button.

The screenshot shows a dialog box titled "OR Joint(No.1)". It contains three radio button options:

- (1) **Condition specification**: Trigger occurs when the condition has been met after comparing the data and constant or the data and data. It includes fields for "Device name", "Condition type", and "Data type".
- (2) **Fixed scan**: Trigger occurs in each specified cycle. It includes a text box for a cycle value in milliseconds [ms] with a range of (1 - 86400000).
- (3) **Event occurrence**: Trigger occurs when the event or error of the corresponding event history occurs. It includes instructions on specifying event codes or error codes using hyphens and commas.

At the bottom of the dialog are "OK" and "Cancel" buttons.

Displayed items

Item		Description
(1) Condition specification	—	Select this to make a trigger occur when the target data meets the specified condition.
	Device name/Label name ^{*1}	Select the target data to which a condition is to be set.
	Target data name ^{*2*3*4*5}	Enter the name of the target data.
	Condition type	Select a comparison condition of the target data. When condition specification is selected, items to set a condition formula and comparison target data name are displayed. (Page 35 When "Condition specification" is selected for "Condition type")
	Data type ^{*6}	Specify a type of the target data. When a label name is specified for a device name/label name and target data name, a data type according to the label is displayed.
(2) Fixed scan	—	Select this to make a trigger occur at the specified cycle.
	Fixed scan specification	Enter a cycle to be specified as a numerical value.
(3) Event occurrence	—	Select this to make a trigger occur when a specified event or error occurs.
	Event code/error code specification	Specify an event code or error code. Multiple event codes/error codes can be specified by using a hyphen (-) or comma (.). When delimiting the event codes/error codes by using comma (,), up to 36 codes can be specified.

- *1 "Label name" can be selected when a GX Works3 project has been read.
- *2 If a GX Works3 project has been read, up to 100 options are displayed when entering a label name. (Page 24 Reading a GX Works3 Project)
- *3 Labels which include a special character (such as an umlaut character) may not be specified.
- *4 When the target data is a label, only labels whose name is less than 256 characters can be specified.
- *5 When the target data is a local label of a function block, a sampled data is an indefinite value. Therefore, do not specify a local label of a function block.
- *6 When the target data is a timer type device and counter type device, its data type is set as follows. These data types cannot be changed.
 - T, ST, C: Word [unsigned]
 - LT, LST, LC: Double word [unsigned]

■When "Condition specification" is selected for "Condition type"

When "Condition specification" is selected for "Condition type," setting items of a condition formula and data name of the comparison target are displayed.

Window

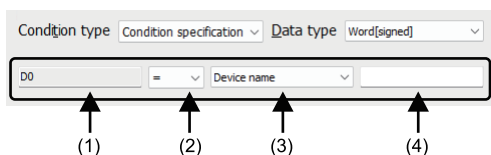

Displayed items

The following table shows the setting items to be displayed.

Item	Description
(1) Target data name display	A device name or label name entered as a target data name is displayed.
(2) Condition formula	Select a condition formula to compare the data.
(3) Comparison device name/label name/constant	Select the data to be set as a comparison target.
(4) Comparison data name *1*2*3*4	Enter the name or constant of the comparison target data selected in (3).

- *1 If a GX Works3 project has been read, up to 100 options are displayed when entering a label name. (Page 24 Reading a GX Works3 Project)
- *2 Labels which include a special character (such as an umlaut character) may not be specified.
- *3 When the target data is a label, only labels whose name is less than 256 characters can be specified.
- *4 When the target data is a local label of a function block, a sampled data is an indefinite value. Therefore, do not specify a local label of a function block.

Number of records

The following screen is used to specify the number of records to be output before and after trigger occurrences when the trigger logging is selected.

The setting method is the same as that of RCPUs.

For details, refer to the following:

 Page 51 Number of Records

Output

The following screen is used to specify the items to be output into a data logging file.

For the data logging file format specifications and output contents of each data, refer to the manual for the MX Controller used.

☞ RELEVANT MANUALS

Window

Displayed items

Item		Description
Date	Output date ^{*1}	Select the checkbox to add a time stamp to data for the data logging. The date/time format to be output can be set by clicking the [Set Date Line Format] button. ^{*2*3}
Trigger information	Output trigger information	Select the checkbox to add a mark to data that is associated with a trigger occurrence for the data logging. A character string to be added to the data where a trigger has occurred can be specified by clicking the [Set String for Trigger] button.
Index	Output index	Select the checkbox to output the index number used for checking the logging continuity.
Data sampling interval	Output data sampling interval	Select the checkbox to output the data sampling interval.
Execution program name or execution program No.	Output execution program name or program No.	Select the checkbox to output the execution program name and execution program number used for the data sampling.
Device comment output	Output device comment	When the target data is a device, select the checkbox to output a specified comment in addition to the device.
	Target memory	Select the storage memory for the comment file used for displaying a comment.
	Target comment file name	Set a comment file name used for displaying a comment.
	Target comment number ^{*4}	Specify a comment number to be displayed.
	Output each program device comment ^{*5}	—
	Target memory	Specify the memory in which device comment files for each program are stored.
Comment	Output comments	Select the checkbox to output a comment at the top of the file.
	Comment ^{*6}	Enter a comment.

*1 Select this checkbox to sample target data of the data flow analysis function (AI analysis) of GX Works3 by using the data logging function.

*2 Data output format can be created by combining the following formats:

- Year: YYYY for four-digit expression; YY for two-digit expression
- Month: MM
- Day: DD
- Hour: hh
- Minute: mm
- Second: ss

· Millisecond: ms (three-digit expression), or s, ss, sss, ssss, sssss, ssssss, or sssssss (second unit after the decimal point, maximum of seven digits)

(Example) YY/MM/DD hh:mm:ss.sss → 10/10/13 09:44:35.241

- *3 If either of "Year," "Month," "Day," "Hour," "Minute," or "Second" is omitted, when opening the data logging file by GX LogViewer, the index expression is used rather than the time expression.
 GX LogViewer Version 1 Operating Manual
- *4 The target comment number refers to the numbers, which correspond to the comment numbers in the [View] ⇒ [Multiple Comments] ⇒ [Display Setting] of GX Works3.
- *5 "Target comment number" of a device comment for each program is the same as that of a device comment. The device comment for each program is output only when a local device is specified. When a global device is specified, the comments in the device comment file specified for "Target comment file name" are output.
- *6 In the following cases, characters cannot be entered:
 - A character which cannot be handled with the OS language character code is entered.
 - A character is entered with a different character code from the one which has been already entered in the same data logging setting.

Save

The following screen is used to configure the storage destination of data logging files and the switching timing of storage files. For details on the storage files, refer to the manual for the MX Controller used.

☞ RELEVANT MANUALS

Window

Specify the save destination and switching timing of data logging files.

Logging file save setting

File save destination
Specify the logging file save directory (folder name). Data will be stored in the following folder:
/LOGGING/ LOG01

Folder to store file to be saved
Select the additional information to the folder name stored the file to be saved.
 Date(J) Time(K) Example 0000001

File name

Simple setting(Δ) Simply set additional information...
The information which is added from folder name, date, time to file name can be set.

Optional setting Optionally set additional information...
The additional information to the file name can be set freely.
Example 0000001.TXT

File switching setting

Number of files to be saved
Specify the maximum number of files to be saved.
 Do not specify maximum value
Create the file until the capacity of save destination is full.

Number of files to be saved 1 (1-65535)
Operation when exceeds the number of files:
 Overwrite
Files with lower numbers are deleted and logging continues.
 Stop
Logging stops.

File switching timing
Specify the file switching timing.

Number of records 1000 [Record] (1-100000)
A logging file is switched to the new one when the number of records exceeds the specified value.

File size [KB] (10-16384)
A logging file is switched to the new one when the file size exceeds the specified value.

Condition specification Condition setting...
A logging file is switched to the new one when the device value satisfies the condition.

Displayed items

Item		Description			
Logging file save setting	File save destination	Specify a storage folder for a data logging file.			
	Folder to store file to be saved	Select information to be added to the name of the folder which stores the storage file.			
	File name	<table border="0"> <tr> <td>Simple setting</td> <td>Click the [Simply set additional information] button, and set the information to be added to the storage file name from a storage folder name, date, and time.</td> </tr> <tr> <td>Optional setting^{*1}</td> <td>Click the [Optionally set additional information] button, and set any information to be added to the storage file name.</td> </tr> </table>	Simple setting	Click the [Simply set additional information] button, and set the information to be added to the storage file name from a storage folder name, date, and time.	Optional setting ^{*1}
Simple setting	Click the [Simply set additional information] button, and set the information to be added to the storage file name from a storage folder name, date, and time.				
Optional setting ^{*1}	Click the [Optionally set additional information] button, and set any information to be added to the storage file name.				
File switching setting	Number of files to be saved	Do not specify maximum value	Select the checkbox to continue to save files until free space on the storage destination runs out without setting the maximum number of storage files.		
		Number of files to be saved	Specify the maximum number of storage files.		
		Operation when exceeds the number of files	Select the operation when the maximum number of storage files is exceeded.		
	File switching timing ^{*2}	Number of records	Select the timing at which the file is replaced with new one. For "Number of records," the file is replaced when the specified number of records is exceeded.		
	File size	For "File size," the file is replaced when the specified file size is exceeded.			
	Condition specification	For "Condition specification," the file is replaced when the device value meets the condition.			

*1 Maximum of 64 single-byte characters (including an underscore (_), a serial number (eight digits), a period, and an extension) can be used.
However, when a character string that contains double quotation marks (" ") is specified, the maximum number reduces by the number of the double quotation marks.

In a process CPU (redundant mode), since three characters of an identifier are added to a file name at system switching, the save file name should be within 61 single-byte characters (including underscores (_), a serial number (eight digits), a period, and an extension).

*2 Reducing the setting value results in frequent file switching; therefore, the scan time and/or the device/label access service processing time may be extended.

Movement

The following screen is used to set the data logging operation.

Window

Specify logging operation.

Logging start condition
Specify logging operation at data logging settings registered status when the CPU module power is ON
->RUN, reset->RUN, or the CPU module operation status is STOP->RUN.

- Auto start at initial completion
- Auto start at transition to RUN
- Start by user operation

Logging stop condition
Set the conditions for stopping data logging settings.

- Stop when transitioning to a state other than RUN
- Stop by user operation

Displayed items

Item	Description
Logging start condition	Set a condition to start data logging.
Logging stop condition	Set a condition to stop data logging.

Finish

The following screen is used to set a data logging setting name.

In addition, the total size of a logging file to be output and required internal buffer capacity for logging are displayed.

The setting method is the same as that of RCPUs.

For details, refer to the following:

 Page 57 Finish

6.2 Data Logging Setting for RCPUs

This section shows the setting method of data logging of RCPUs.

Logging setting list screen

In the logging setting list screen, data logging settings are displayed in a list.

Window

Select "RCPU" ⇒ "Data Logging Setting" in the edit item tree.

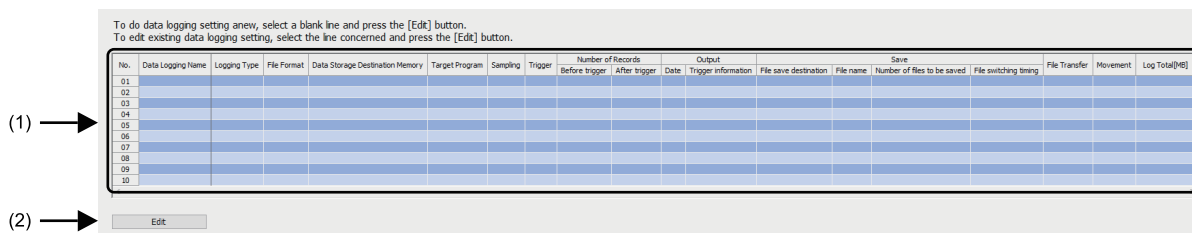

Displayed items

Item		Description
(1) Logging setting list	—	The data logging settings are displayed in a list. (Up to 10 settings)
	No.	The data logging setting number is displayed. (No. 01 to 10)
	Data Logging Name	The name of a set data logging is displayed.
	Setting contents	The setting contents of a data logging setting are displayed.
(2) [Edit] button		Click this to display the wizard screen to configure the data logging settings. When a blank row is selected, a new data logging setting can be created. When a data logging setting is selected, the setting can be edited.

Logging type setting

The following screen is used to set the following items of the data logging: type, target data, file format, and storage destination of a data logging file.

For details on the data logging types and data logging files, refer to the manual for the CPU module used.

RELEVANT MANUALS

Window

Click the [Edit] button in the logging setting list screen.

First off, select a logging type.

Logging type
Select a logging type.

Continuous logging
Logging is carried out continuously at the specified data sampling intervals. Interval at which or conditions under which to carry out logging can also be specified.

Trigger logging
By monitoring data, data before and after a condition held true is logged.

Logging target
Select the type of condition specification and logging target. Read the project when the label is specified. Also, select "Label can also be specified in logging target", when the device and label are specified in logging target.

Device
 Label can also be specified in logging target

Label(L)

Target program name

Specify the program name that includes a label when the local label is used. Specify the program name included in read project by [Project] menu -> [Read GX Works3 Project].

File format
Select the file format which outputs the logging.

Unicode text file
The data can be checked not only by GX LogViewer but also by text editor or table calculation soft. Unicode string will be output.

CSV file
The data can be checked not only by GX LogViewer but also by text editor or table calculation soft. ASCII string will be output.

Binary file
The data in the file can be checked by GX LogViewer. Compare with Unicode text file, the file volume can be decreased. Select the binary file when GX Works3 offline monitor (logging) function is used.

Data storage destination memory
Select logging file storage destination memory.

SD memory card
Save sampled data to SD memory card that is portable storage media. It can be transferred to FTP server after saving.

CPU built-in memory (function memory)
It can be transferred to FTP server after saving sampled data to function memory that is CPU built-in memory. It will be transferred to data memory after completing or stopping logging when it is not transferred to FTP server.

Displayed items

Item			Description
Logging type			Select a logging type.
Logging target	Device	—	Select this to specify a device as the target data in the "Sampling" setting screen, "Data" setting screen, and "Trigger" setting screen.
		Label can also be specified in logging target* ¹	Select the checkbox to specify both devices and labels as the target data in the "Data" setting screen.
	Label* ¹		Select this to specify a label as the target data in the "Sampling" setting screen, "Data" setting screen, and "Trigger" setting screen.
	Target program name		When either of the following items is selected in "Logging target," enter the target program name to specify a local label in a program block: <ul style="list-style-type: none"> Label can also be specified in logging target Label
File format* ¹			Select an output file format.
Data storage destination memory* ¹			Select the storage destination of a data logging file.

*¹ To specify this item, check the CPU module types and firmware versions supporting this.

For details on the firmware version, refer to "Added and Enhanced Functions" in the manual for the CPU module used.

RELEVANT MANUALS

Sampling

The following screen is used to configure the sampling interval and sampling start conditions. For details on the conditions to sample data, refer to the manual for the CPU module used.

☞ RELEVANT MANUALS

Window

Specify the sampling interval and start conditions.

Sampling interval

Each scanning cycle
 Samples data at each sequence scanning cycle.

Time specification
 Samples data at the specified time interval.
 Sample data at the next END processing after the specified time has elapsed(W)

Interrupt occurrence(M)
 Sample data by multiple interval of the interrupt cycle [ms] of the specified interrupt pointer.
 The interrupt pointer will be operated by setting cycle in GX Works3 parameter.
 Consider the added process time for the data logging function and then set the fixed cycle interval of the interrupt program.
 An error may occur when the fixed cycle interval of the interrupt program is short.
 Interrupt pointer(Q) [] (1-50) x Interrupt cycle [ms]

Condition specification
 Specifies data sampling timing by device data conditions or step No.
 If both "device specification" and "step No. specification" are selected, data will be sampled when both conditions are met.

Device specification(J)
 Device [] Conditional formula [] Radix [] Value []
 Data type(K) []

Step No. specification
 Samples data when the status immediately before execution of the specified step satisfies the specified execution conditions.
 Program name [] Step No. [] Execution condition []

Displayed items

Item	Description		
Each scanning cycle	Select this to sample data on every scan.		
Time specification	—	Select this to sample data at the specified time interval.	
	Sampling time value	Specify a sampling interval value.	
	Sample data at the next END processing after the specified time has elapsed	Select the checkbox to sample data at the timing of the next END processing after the specified time has elapsed.	
Interrupt occurrence	—	Select this to sample data at the specified interval after executing an interrupt program.	
	Interrupt pointer	Select an interrupt cycle.	
	Multiple	Specify a multiple applied to the interval value.	
Condition specification	—	Select this to sample data when a set condition is satisfied.	
	Device specification ¹ / Label specification ²	—	Specify each item for sampling data at the END processing where the specified device condition/label condition has been satisfied. If both the step number condition and device condition/label condition are specified, the data is sampled when the both conditions are satisfied.
		Device/Label ^{3,4}	For "Device specification," enter the device name. For "Label specification," enter the label name.
		Data type	Select a data type when a device is specified as the target data. When a label is specified as the target data, a data type is displayed according to the data type of the label.
		Conditional formula	Select a condition formula.
		Radix	Set a radix of a condition value.
		Value	Enter a value to be compared with a device value or label value.
	Step No. specification	—	Select this to sample data when the condition is satisfied immediately before execution of the specified step number.
		Program name	Enter the target program name.
		Step No.	Specify a step number.
Execution condition		Select an execution condition to sample data.	

- *1 Displayed when "Device" is specified as "Logging target" in the "Logging type" setting screen.
- *2 Displayed when "Label" is specified as "Logging target" in the "Logging type" setting screen.
- *3 Labels which include a special character (such as an umlaut character) may not be specified.
- *4 When the target data is a label, only labels whose name is less than 256 characters can be specified.

Data

The following screen is used to set the target data to be sampled.

For details on the target data and output formats, refer to the manual for the CPU module used.

☞ RELEVANT MANUALS

Window

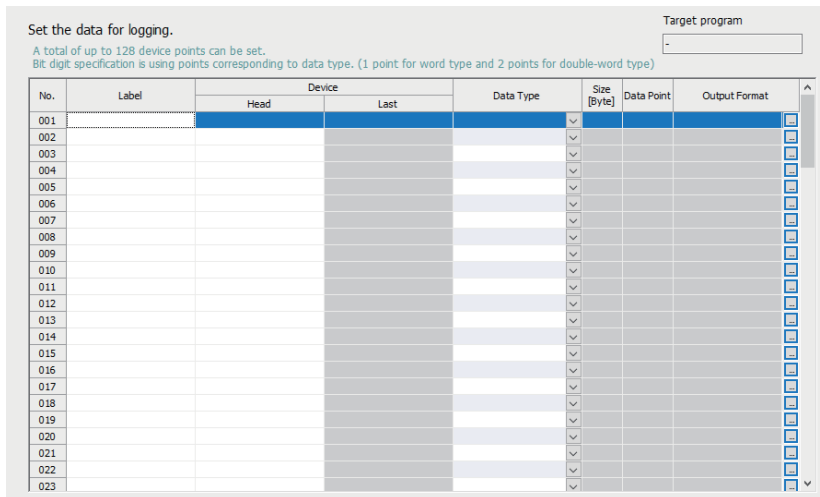



Displayed items

Item	Description	
No.	The data setting numbers from 001 to 128 are displayed.	
Label ^{*1}	<p>Set a target label.^{*2}3*4*5*6*7*8</p> <p>Set this when "Label" or the checkbox of "Label can also be specified in logging target" is selected in the "Logging type" setting screen.</p> <p>■When setting a global label Enter "Label name." Example: "label_w1" For the label of timer type/retentive timer type/counter type, specify the element name. (S: contact, C: coil, N: current value) Example: "label_w1.S"</p> <p>■When setting a local label Enter "Program block name/Label name." Example: "ProgPou/label_w1" For the label of timer type/retentive timer type/counter type, specify the element name. (S: contact, C: coil, N: current value) Example: "ProgPou/label_w1.S"</p> <p>■When setting a structure element Enter "Label.Element name." For the label of timer type/retentive timer type/counter type, specify the element name. (S: contact, C: coil, N: current value) Example: "tmLabel.S"</p> <p>■When setting an array element Enter "Label name[Element number of third dimension][Element number of second dimension][Element number of first dimension]."^{*10}*11</p> <p>■When setting a structure array member Enter "Label name[Element number of third dimension][Element number of second dimension][Element number of first dimension].Member name."^{*10}*11</p>	
Device	Head	<p>Set the start device number.^{*7}*9</p> <p>Set this when "Device" is specified in the "Logging type" setting screen. To specify a local device^{*1}, use "Program name/#Device name." (Example: "MAIN/#M1")</p>
	Last	The end device number calculated based on the data type and size is displayed.
Data Type	<p>When the target data is a label, a data type is displayed according to the data type of the label.</p> <p>When the target data is a device, select a data type.</p>	
Size [Byte]	<p>When the target data is a label, a size is displayed for "String" data type.</p> <p>When the target data is a device, specify a data size for "String" or "Raw" data type.</p>	
Data Point	The number of data points of the data type is displayed.	
Output Format ^{*12}	Click the [...] button at the rightmost part to display the "Output Format (integer/float)" screen for each row. Select the format to be used when data is output to the file.	

Item	Description
Target program	This is displayed when "Target program name" is set in the "Logging type" setting screen.

- *1 To specify this item, check the CPU module types and firmware versions supporting this.
For details on the firmware version, refer to "Added and Enhanced Functions" in the manual for the CPU module used.
 RELEVANT MANUALS
- *2 When the entered label name is valid, it is used as it is. Therefore, the case may differ between the label name defined in GX Works3 and the label name displayed in the screen.
- *3 The labels that cannot be watched in GX Works3 are not available.
- *4 Labels which include a special character (such as an umlaut character) may not be specified.
- *5 Only labels whose name is less than 256 characters can be specified.
- *6 When the target data is a string [Unicode] type label, only labels whose data length is less than 128 characters can be specified.
- *7 To sample target data of the data flow analysis function (AI analysis) of GX Works3 by using the data logging function, specify the analysis target devices/labels.
- *8 For safety CPUs, only standard labels can be specified.
- *9 For safety CPUs, only standard devices can be specified.
- *10 If an array element is not specified, it is handled as the start of the array ([0]). (Example: When "bLabel1[0..9]" exists and "bLabel1" is entered, it is handled as "bLabel1[0].")
- *11 If the entered array is out of the range, an undefined value is specified.
- *12 When the data type of the target data is "Bit," "String," "Row," or "Time," the output format cannot be changed.

Point 

- To paste a device/label which is copied in another application (such as a watch window of GX Works3 or GX Works2, a spreadsheet, or a text editor), use "Paste device/label copied in other application software" or "Insert device/label copied in other application software." ( Page 48 Pasting/inserting a device or label copied in another application).
- To insert data into the data list in a batch, use "Batch Data Insertion." ( Page 49 Inserting data in a batch)

Pasting/inserting a device or label copied in another application

A device or label which is copied in another application (such as a watch window of GX Works3 or GX Works2, a spreadsheet, or a text editor) can be pasted into a selected row in the "Data" setting screen.

Operating procedure

In the "Data" setting screen, select a row where copied data is to be pasted, and select the item from the right-click menu.

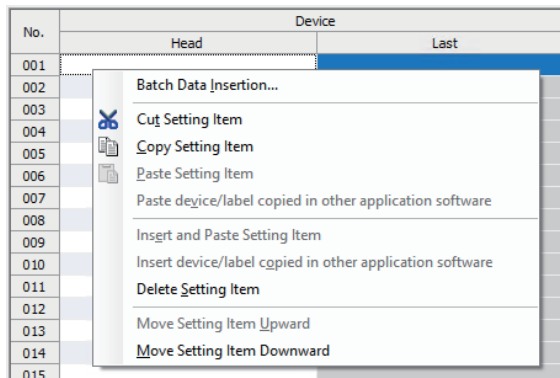

Point

The shortcut key for "Paste device/label copied in other application software" is "**Ctrl** + **Shift** + **V**." Note that this shortcut key is valid only when the "Head" column under "Device" or "Label" column is selected.

Operation details

The following table shows the operation details of pasting and inserting.

Item	Operation
Paste device/label copied in other application software	To overwrite a device or label which is copied in another application in a selected row. (Existing data in the selected row is deleted.)*1*2 For devices, settings other than start devices are entered as default settings corresponding to each device.
Insert device/label copied in other application software	To paste a device or label which is copied in another application into a selected row, and shift down existing data in the selected row and below.*1*2 For devices, settings other than start devices are entered as default settings corresponding to each device.

*1 Strings of each row in the clipboard which are from the start to the new line or the first tab delimited are pasted or inserted.

*2 If a copied string is invalid as a device/label, it cannot be pasted or inserted.

Inserting data in a batch

The following screen is used to insert data into the data list in a batch. Data is inserted into blank rows in the list of the "Data" setting screen in order from the top (when a setting already exists in the target insertion row, the row is skipped without overwriting it).

Window

Select [Edit] ⇒ [Batch Data Insertion].

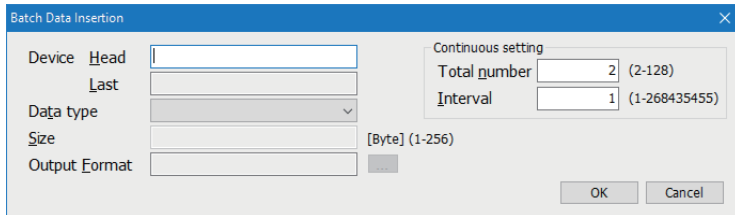

Operating procedure

Set each item and click the [OK] button.

Displayed items

Item		Description
Device	Head	Specify the start device number. Only global devices can be entered. (Local devices cannot be entered.)
	Last	The end device number calculated based on the data type and size is displayed.
Data type		Select a type of the data to be inserted in a batch.
Size		Specify the data size when the data type is set to "String" or "Raw."
Output Format		Click the [...] button at the rightmost part to display the "Output Format (integer/float)" screen for each row. Select the format to be used when data is output to the file.
Continuous setting	Total number	Specify the total number of data to be inserted in a batch.
	Interval	Specify the device interval of data to be inserted in a batch.

Trigger

The following screen is used to specify the trigger condition when the trigger logging is selected. For details on the trigger logging, refer to the manual for the CPU module used.

☞ RELEVANT MANUALS

Window

Make trigger setting.

Condition specification
Sets trigger condition with device data values and step No. If both "Device change specification" and "Step No. specification" are selected, an AND condition of each setting is required to be met.

<input checked="" type="checkbox"/> Device change specification ⁽¹⁾	Conditional formula	Radix	Value
Device			
Data type ^(k)			

Step No. specification
Conditions met when the status immediately before execution of the specified step satisfies the specified execution conditions.

Target program name	Step No.	Execution condition

When trigger instruction executed
Trigger conditions met when LOGTRG instruction is executed.

Displayed items

Item	Description	
Condition specification	—	Select this to make a trigger occur when a set condition is satisfied.
Device change specification ^{*1} /Label change specification ^{*2}	—	Select the checkbox to configure a trigger condition based on the device data condition or label data condition.
	Device/Label ^{*3*4}	For "Device change specification," enter the device name. ^{*5} For "Label change specification," enter the label name. ^{*6}
	Data type	Select a data type when a device is specified as the target data. When a label is specified as the target data, a data type is displayed according to the data type of the label.
	Conditional formula	Select a condition formula.
	Radix	Set a radix of a condition value.
	Value	Enter a value to be compared with a device value or label value.
	Step No. specification	—
Target program name		Enter the target program name.
Step No.		Specify a step number.
Execution condition		Select an execution condition to make a trigger occur.
When trigger instruction executed		Select this to make a trigger occur when the LOGTRG instruction is executed.

*1 Displayed when "Device" is specified as "Logging target" in the "Logging type" setting screen.

*2 Displayed when "Label" is specified as "Logging target" in the "Logging type" setting screen.

*3 Labels which include a special character (such as an umlaut character) may not be specified.

*4 When the target data is a label, only labels whose name is less than 256 characters can be specified.

*5 For safety CPUs, only standard devices can be specified.

*6 For safety CPUs, only standard labels can be specified.

Number of Records

The following screen is used to specify the number of records to be output before and after trigger occurrences when the trigger logging is selected.

Window

Data before and after trigger condition rises will be logged.
Specify the numbers of records before and after trigger.

No. of records (before trigger)	<input type="text" value="1"/>	[Record] (0~999999)
No. of records (after trigger)	<input type="text" value="1"/>	[Record] (1~1000000)
Total No. of records	<input type="text" value="2"/>	[Record] (1~1000000)

Displayed items

Item	Description
No. of records (before trigger)	Specify the number of records to be output as before-trigger record.
No. of records (after trigger)	Specify the number of records to be logged during and after a trigger occurrence.
Total No. of records	The total number of before-trigger and after-trigger records is displayed.

Output

The following screen is used to specify the items to be output into a data logging file.

For the data logging file format specifications and output contents of each data, refer to the manual for the CPU module used.

☞ RELEVANT MANUALS

Window

The screenshot shows a configuration window titled "Setting items to be output to a file." with the following sections:

- Date:** "Carry out the logging with a time stamp attached to data." Includes a checked "Output date" checkbox and a "Set Date Line Format..." button.
- Trigger information:** "Data on which a trigger occurred is logged after attached with a mark." Includes a checked "Output trigger information" checkbox and a "Set String for Trigger..." button.
- Index:** "Output index numbers for checking the continuity of logging." Includes a checked "Output index" checkbox.
- Data sampling interval:** "Output data sampling interval time." Includes a checked "Output data sampling interval(I)" checkbox.
- Execution program name or execution program No.:** "Output execution program name and execution program No. which the data has been sampled." Includes a checked "Output execution program name or program No." checkbox.
- Execution step No.:** "Output step No. which the data has been sampled." Includes a checked "Output execution step No." checkbox.
- Device comment output:** "In addition to device of data, output device comment." Includes:
 - Unchecked "Output device comment(R)" checkbox with "Target memory" dropdown.
 - Unchecked "Output each program device comment(Q)" checkbox with "Target memory(W)" dropdown.
 - Input fields for "Target comment file name" and "Target comment number (1-16)".
- Comment:** "Outputs comments on the settings. The specified comment will be output at the top of the logging file." Includes a checked "Output comments" checkbox and a "Comment(K)" text box containing "LOG01".

Displayed items

Item		Description
Date	Output date ^{*1}	Select the checkbox to add a time stamp to data for the data logging. The date/time format to be output can be set by clicking the [Set Date Line Format] button. ^{*2*3}
Trigger information	Output trigger information	Select the checkbox to add a mark to data that is associated with a trigger occurrence for the data logging. A character string to be added to the data where a trigger has occurred can be specified by clicking the [Set String for Trigger] button.
Index	Output index	Select the checkbox to output the index number used for checking the logging continuity.
Data sampling interval	Output data sampling interval	Select the checkbox to output the data sampling interval.
Execution program name or execution program No.	Output execution program name or program No.	Select the checkbox to output the execution program name and execution program number used for the data sampling.
Execution step No.	Output execution step No.	Select the checkbox to output the step number used for the data sampling.
Device comment output	Output device comment	When the target data is a device, select the checkbox to output a specified comment in addition to the device.
	Target memory	Select the storage memory for the comment file used for displaying a comment.
	Target comment file name	Set a comment file name used for displaying a comment.
	Target comment number ^{*4}	Specify a comment number to be displayed.
	Output each program device comment ^{*5}	—
	Target memory	Specify the memory in which device comment files for each program are stored.
Comment	Output comments	Select the checkbox to output a comment at the top of the file.
	Comment ^{*6}	Enter a comment.

- *1 Select this checkbox to sample target data of the data flow analysis function (AI analysis) of GX Works3 by using the data logging function.
- *2 Data output format can be created by combining the following formats:
 - Year: YYYY for four-digit expression; YY for two-digit expression
 - Month: MM
 - Day: DD
 - Hour: hh
 - Minute: mm
 - Second: ss
 - Millisecond: ms (three-digit expression), or s, ss, sss, ssss, sssss, ssssss, or sssssss (second unit after the decimal point, maximum of seven digits)(Example) YY/MM/DD hh:mm:ss.sss → 10/10/13 09:44:35.241
- *3 If either of "Year," "Month," "Day," "Hour," "Minute," or "Second" is omitted, when opening the data logging file by GX LogViewer, the index expression is used rather than the time expression.
 GX LogViewer Version 1 Operating Manual
- *4 The target comment number refers to the numbers, which correspond to the comment numbers in the [View] ⇒ [Multiple Comments] ⇒ [Display Setting] of GX Works3.
- *5 "Target comment number" of a device comment for each program is the same as that of a device comment. The device comment for each program is output only when a local device is specified. When a global device is specified, the comments in the device comment file specified for "Target comment file name" are output.
- *6 In the following cases, characters cannot be entered:
 - A character which cannot be handled with the OS language character code is entered.
 - A character is entered with a different character code from the one which has been already entered in the same data logging setting.

Save

The following screen is used to configure the storage destination of data logging files and the switching timing of storage files. For details on the storage files, refer to the manual for the CPU module used.

☞ RELEVANT MANUALS

Window

Specify the save destination and switching timing of data logging files.

Logging file save setting

File save destination
Specify the logging file save directory (folder name). Data will be stored in the following folder:
/LOGGING/ LOG01

Folder to store file to be saved
Select the additional information to the folder name stored the file to be saved.
 Date(D) Time(K) Example 00000001

File name
 Simple setting
The information which is added from folder name, date, time to file name can be set.
 Optional setting
The additional information to the file name can be set freely.
Example 00000001.TXT

File switching setting

Number of files to be saved
Specify the maximum number of files to be saved.
Number of files to be saved (1-65535)
Operation when exceeds the number of files:
 Overwrite
Files with lower numbers are deleted and logging continues.
 Stop
Logging stops.

File switching timing
Specify the file switching timing.
 Number of records [Record] (1-65500)
A logging file is switched to the new one when the number of records exceeds the specified value.
 File size [KB] (10-16384)
A logging file is switched to the new one when the file size exceeds the specified value.
 Condition specification
A logging file is switched to the new one when the device value satisfies the condition.

Displayed items

Item	Description		
Logging file save setting	File save destination	Specify a storage folder for a data logging file.	
	Folder to store file to be saved	Select information to be added to the name of the folder which stores the storage file.	
	File name	<input checked="" type="radio"/> Simple setting Click the [Simply set additional information] button, and set the information to be added to the storage file name from a storage folder name, date, and time. <input type="radio"/> Optional setting*1 Click the [Optionally set additional information] button, and set any information to be added to the storage file name.	
File switching setting	Number of files to be saved	Number of files to be saved	Specify the maximum number of storage files.
		Operation when exceeds the number of files	Select the operation when the maximum number of storage files is exceeded.
	File switching timing*2	Number of records	Select the timing at which the file is replaced with new one.
		File size	For "Number of records," the file is replaced when the specified number of records is exceeded. For "File size," the file is replaced when the specified file size is exceeded.
Condition specification*3		For "Condition specification," the file is replaced when the device value meets the condition.	

*1 Maximum of 64 single-byte characters (including an underscore (_), a serial number (eight digits), a period, and an extension) can be used. However, when a character string that contains double quotation marks (" ") is specified, the maximum number reduces by the number of the double quotation marks.

In a process CPU (redundant mode), since three characters of an identifier are added to a file name at system switching, the save file name should be within 61 single-byte characters (including underscores (_), a serial number (eight digits), a period, and an extension).

*2 Reducing the setting value results in frequent file switching; therefore, the scan time and/or the device/label access service processing time may be extended.

*3 To specify this item, check the CPU module types and firmware versions supporting this.

For details on the firmware version, refer to "Added and Enhanced Functions" in the manual for the CPU module used.

☞ RELEVANT MANUALS

File Transfer

The following screen is used to specify the destination when data logging files are sent to the FTP server by using the data logging file transfer function of a CPU module.

For details on the data logging file transfer function, refer to the manual for the CPU module used.

☞ RELEVANT MANUALS

Window

Data logging files can be transferred to the specified FTP server at the file switching timing.

Transferring files to the FTP server
If the auto logging function is enabled, this function cannot be used.
 Auto transfer to data memory after logging is completed when users specify the function memory in data stored destination memory beforehand and do not use the function.

Server Setting...

No.	FTP Server	Login User Name	Password	Directory Path	Data Transfer Mode
01					
02					
03					
04					
05					
06					
07					
08					
09					
10					

*If the same directory path in the same transfer destination server is set to another CPU module, the transferred file may be overwritten.
 Set the FTP server and directory path correctly.

FTP server connection request timeout time [s] (1-30)

File transfer retry time [m] (1-1440)
Files are repeatedly resent during the file transfer retry time.

Adjust directory configuration of FTP server by CPU
Specify a configuration stored in the directory path of transfer destination FTP server.
 When users do not specify it, save logging files in the directory of transfer destination FTP server.

Delete files completed transfer
Delete transferred files in SD memory card or function memory.

Displayed items

Item	Description	
Transferring files to the FTP server*1	Select the checkbox to transfer files to the FTP server.	
[Server Setting] button	FTP Server Name	Specify the FTP server with an IP address or server name. To specify the FTP server with an IP address, enter a value in the decimal format. To specify the FTP server with a server name, select the server name. When specifying a server name, set DNS in GX Works3 from the following: • [Module Parameter] ⇄ [Application Settings] ⇄ [DNS Settings]
	Port No.	Set an FTP server control port number.
	Login User Name	Set an FTP server account (user name).
	Login Password	Set an FTP server login password.
	Confirm Login Password	
	Directory Path	Set the directory path of the file transfer destination. If the specified directory path does not exist, an error occurs at file transfer. When transferring data logging files to the same FTP server from multiple CPU modules, specify different directory paths for the file transfer destinations. If the same directory path is specified, files may be overwritten with each other.
	Data Transfer Mode	Specify the FTP data transfer mode. Generally, specify the PORT mode. If communications between the CPU module and the FTP server allow only the PASV mode due to Windows firewall, specify the PASV mode.
[File Transfer Test] button	Click this to execute the file transfer test.	
Transfer Destination Server Setting List	Settings for each setting number configured in the "FTP Setting" screen are displayed. The contents of the settings that should not be duplicated with other settings such as directory path can be checked.	
FTP server connection request timeout time	Set the waiting time from when the connection request from the CPU module to the FTP server is sent to when the response is received.	
File transfer retry time	Set the time to retry the file transfer when the file transfer fails due to an error caused by communication failure such as the network error between the CPU module and the FTP server.	
Adjust directory configuration of FTP server by CPU	Select the checkbox to automatically create a directory in the directory path specified by the FTP server so that the structure is the same as the storage destination when transferring a data logging file.	
Delete files completed transfer	Select the checkbox to automatically delete transferred files at the completion of data logging file transfer. When "CPU built-in memory (function memory)" is specified for the storage destination of the data logging files, the setting is always selected.	

*1 To specify this item, check the CPU module types and firmware versions supporting this.

For details on the firmware version, refer to "Added and Enhanced Functions" in the manual for the CPU module used.

☞ RELEVANT MANUALS

Movement

The following screen is used to set the data logging operation.

Window

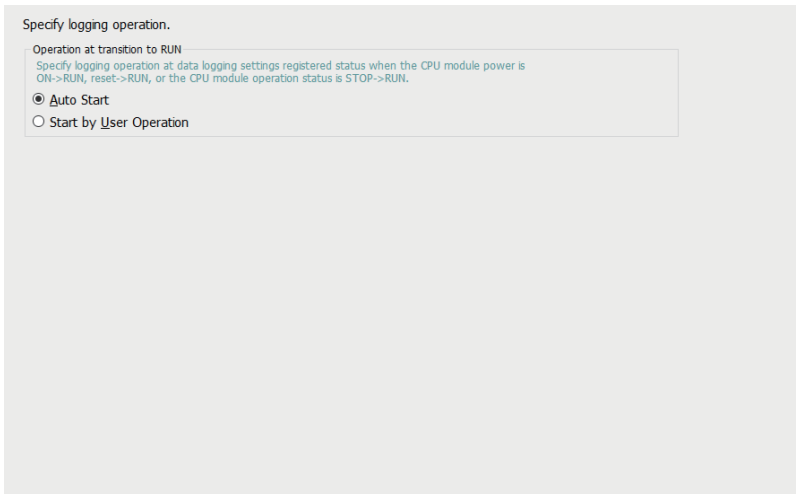

Displayed items

Item	Description
Operation at transition to RUN	Select the operation when the operating status of the CPU module is switched to RUN state.

Finish

The following screen is used to set a data logging setting name.

In addition, the total size of a logging file to be output and required internal buffer capacity for logging are displayed.

For details on the internal buffer capacity, refer to the manual for the CPU module used.

 RELEVANT MANUALS

Window

All data required for data logging have been collected.
Press the "Complete" button to complete setting.

To reflect the settings to the PLC, select [Online]->[Write Logging Setting].
Name the data logging.

Data logging name

Free space volume below will be necessary to execute logging of the set content.
Larger volume might be necessary depending on status of data storage destination memory.

Total Size of Output Logging Files [MB]

To execute logging of the settings, the following internal buffer capacity is required.
Please set internal buffer capacity as needed.

Required Internal Buffer Capacity in Logging [KB]

The internal buffer capacity can be set in
"Parameter->Control CPU->CPU Parameter->Memory/Device Setting->Internal Buffer Volume Setting" of GX Works3.
Default value: 128[KB]

Displayed items

Item	Description
Data logging name*1	Enter any name of the data logging setting being configured.
Total Size of Output Logging Files*2	The total capacity of data logging files which are output based on the specified settings is displayed. It can be adjusted by items to be output to the files.
Required Internal Buffer Capacity in Logging	The internal buffer capacity required to execute the data logging based on the specified settings is displayed. It can be specified in the internal buffer capacity setting of GX Works3.

*1 In the following cases, characters cannot be entered:

- A character which cannot be handled with the OS language character code is entered.
- A character is entered with a different character code from the one which has been already entered in the same data logging setting.

*2 For transferring a data logging file from the CPU built-in memory (function memory) to the data memory, the free space in the data memory can be checked in the "Online Data Operation" screen of GX Works3. ( GX Works3 Operating Manual)

7 COMMON SETTING

The common setting includes the auto logging common setting.

For details on the auto logging function of a CPU module, refer to "Auto Logging" in the manual for the CPU module used.

☞ RELEVANT MANUALS

Operating procedure

Select "MX Controller (MX-R Model)," "MX Controller (MX-F Model)," or "RCPU" ⇒ "Common Setting" ⇒ "Auto logging common setting" in the edit item tree.

7.1 Auto Logging Common Setting

The following screen is used to configure the required settings for using the auto logging function.

Window

Set for auto logging function.

Enable the auto logging function
Inserting an SD memory card into the CPU in RUN status starts operation.
Save the target data logging setting in the SD memory card before inserting the card.

The auto logging function does not operate according to the logging setting in the data memory.
Logging being operated when the SD memory card is inserted,
the auto logging function does not start operating.

Auto logging terminate condition
Specify conditions for terminating auto logging.
If two or more conditions are selected, logging will terminate when any of the conditions is met.

Data logging stop
Select when to terminate auto logging operation.

When all data loggings stop
 When any of the data loggings stops

Timer

Complete with timer
Terminates logging after a specified period of time has elapsed after logging starts.

Elapsed time [s] (1-86400)

Displayed items

Item	Description		
Enable the auto logging function	Select the checkbox to use auto logging.		
Auto logging terminate condition	Data logging stop	Select a condition to complete the auto logging operation.	
	Timer	Complete with timer	Select the checkbox to stop the auto logging operation by a timer.
		Elapsed time	Specify the time from the start of the data logging until stopping it.

8 READING/WRITING/DELETING LOGGING SETTINGS

This chapter shows the operations to read, write, and delete logging settings. To perform these operations, set a target CPU module to be connected in advance.

Transfer setup (MX Controller)

The following screen is used to specify the communication route between an MX Controller and a personal computer.

Window

Select [Online] ⇒ [Transfer Setup].

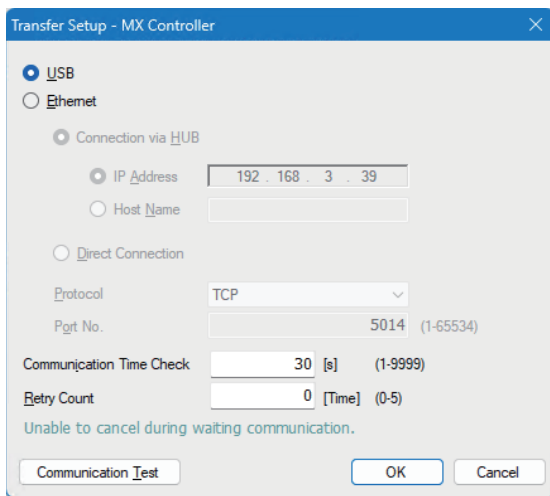

Operating procedure

Set each item and click the [OK] button.

Displayed items

Item	Description	
USB	Select this to connect a personal computer and an MX Controller with a USB cable.	
Ethernet	Connection via HUB	Select this to connect a personal computer and an MX Controller via a hub with an Ethernet cable. Enter the IP address or host name of an MX Controller.
	Direct Connection	Select this to connect a personal computer and an MX Controller directly with an Ethernet cable.
	Protocol	Select any of the following protocols when "Connection via HUB" is selected. <ul style="list-style-type: none"> • TCP • UDP • TLS • DTLS
	Port No.	Specify the port number of an MX Controller when "TLS" or "DTLS" is selected for "Protocol."
	Communication Time Check	Specify the communication time.
	Retry Count	Specify the number of retries.
[Communication Test] button	Click this to check the communication status. For an MX Controller with enabled user authentication, the communication status can be checked without logging on to the MX Controller.	

Transfer setup (RCPU)

The following screen is used to specify the communication route between an RCPUs and a personal computer.

Window

Select [Online] ⇒ [Transfer Setup].

8

Operating procedure

Set each item and click the [OK] button.

Displayed items

Item		Description	
PC Side I/F	Connection Method	Select the connection interface of a personal computer on which CPU Module Logging Configuration Tool is installed.	
PLC Side I/F	Connection Method	Select a target device to be connected to a personal computer.	
	CPU Module	Direct Connection	Select this to connect a personal computer and a CPU module directly with an Ethernet cable.
		Connection via hub	Select this to connect a personal computer and a CPU module via a hub with an Ethernet cable. Enter the IP address or host name of a CPU module, and select a protocol.
	GOT Transparent	Module Side	Specify the IP address of a CPU module to be connected to a GOT.
GOT Side		Specify the IP address, host name, or port number of a GOT to be connected to a personal computer.	
Communication Time Check		Specify the communication time.	
Retry Count		Specify the number of retries.	
Connect to RnPCPU (Redundant Mode)		Select the checkbox to connect to a process CPU (redundant mode), and select a connection target system. ^{*1} Note that the connection target system will not change even though a system switching is performed. To change the connection target system, perform the following operations. <ul style="list-style-type: none"> Opening the "Read Logging Setting" screen, "Delete Logging Setting" screen, "Logging Status and Operation" screen, and "Logging File Operation" screen again Changing the selection of "Online operation" in the "Read Logging Setting" screen and the "Delete Logging Setting" screen Writing logging settings again (when systems are switched after clicking the [Write] button) Restarting monitoring in the "Logging Status and Operation" screen (when monitoring has stopped due to system switching) 	
[Communication Test] button		Click this to check the communication status.	

*1 If "Not Specified System" is selected, the personal computer is connected with the host station.

8.1 Reading Logging Settings

The following screen is used to read the logging setting from the target memory in a CPU module.

Window

Select [Online] ⇒ [Read Logging Setting].

Ex.

MX-R model

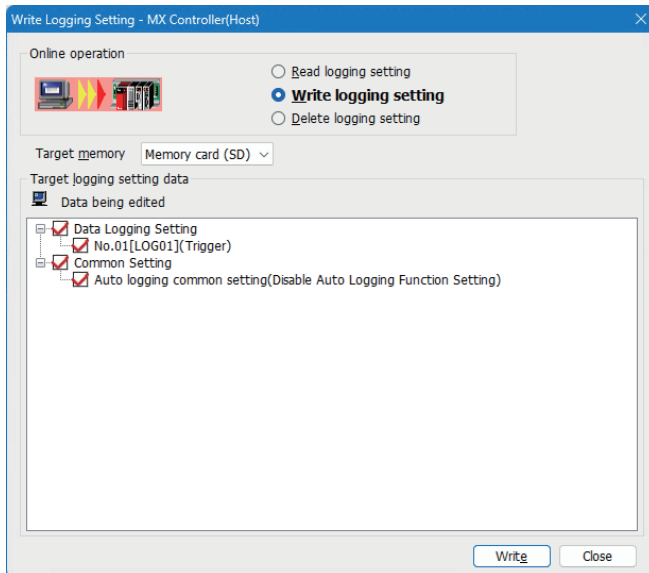

Operating procedure

1. Select the memory where the setting data to be read is stored from "Target memory."
2. Select the checkbox of the setting data to be read in "Target logging setting data," and click the [Read] button.

Point

Any existing data (data logging setting with the same setting number or common setting) on the target is overwritten.

Precautions

When connecting to an MX Controller with enabled user authentication, the "User Authentication (PLC)" screen appears. The user name and password registered to the MX Controller need to be entered to log on.

User authentication can be enabled in GX Works3.

For details, refer to the following:

 GX Works3 Operating Manual

8.2 Writing Logging Settings

The following screen is used to write the logging setting to the target memory in a CPU module.

Window

Select [Online] ⇒ [Write Logging Setting].

Ex.

MX-R model

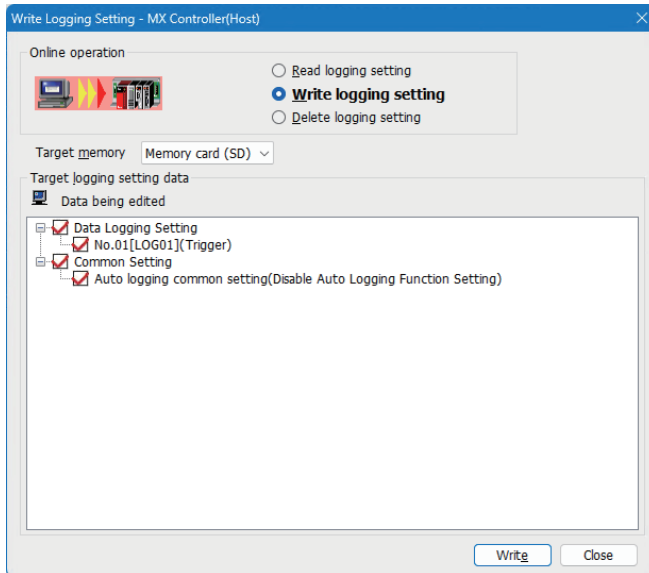

8

Operating procedure

1. Select the memory to which the setting data is written from "Target memory."
2. Select the checkbox of the setting data to be written in "Target logging setting data," and click the [Write] button.*1*2

*1 In the backup mode of a process CPU (redundant mode), data can be written to both systems or one of the systems. Click the [Write] button and a screen appears. Select whether or not to write data to both systems.

*2 The data logging setting using the function memory or data memory as the data storage destination memory cannot be written to an SD memory card. Therefore, the setting is not displayed when "Memory card (SD)" is selected for "Target memory."

Point

Any existing data (data logging setting with the same setting number or common setting) on the target is overwritten.

Precautions

When connecting to an MX Controller with enabled user authentication, the "User Authentication (PLC)" screen appears.

The user name and password registered to the MX Controller need to be entered to log on.

User authentication can be enabled in GX Works3.

For details, refer to the following:

 GX Works3 Operating Manual

8.3 Deleting Logging Settings

The following screen is used to delete the logging setting on the target memory in a CPU module.

Window

Select [Online] ⇒ [Delete Logging Setting].

Ex.

MX-R model

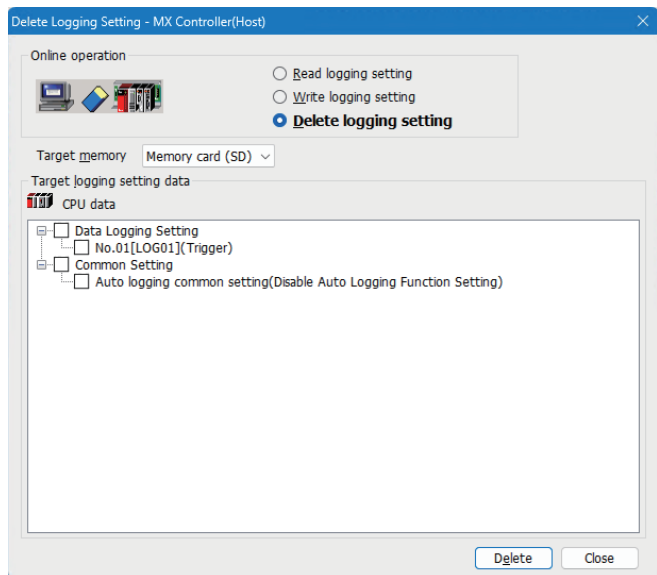

Operating procedure

1. Select the memory where the setting data to be deleted is stored from "Target memory."
2. Select the checkbox of the setting data to be deleted in "Target logging setting data," and click the [Delete] button.

Precautions



When connecting to an MX Controller with enabled user authentication, the "User Authentication (PLC)" screen appears. The user name and password registered to the MX Controller need to be entered to log on.

User authentication can be enabled in GX Works3.

For details, refer to the following:

 GX Works3 Operating Manual

This chapter shows the operation to execute or stop the logging. Also, the logging status can be checked.

To perform this operation, a target CPU module needs to be set in the transfer setup in advance. ( Page 60 Transfer setup (MX Controller),  Page 61 Transfer setup (RCPU))

Window

Select [Online] ⇒ [Logging Status and Operation].

Ex.

MX-R model

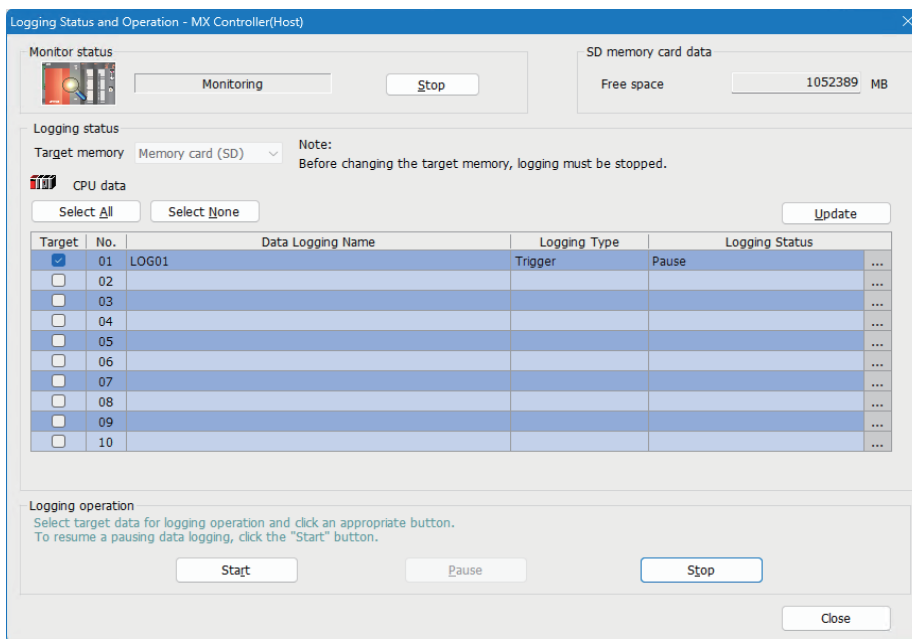

Operating procedure

■ Starting or stopping monitoring

1. Start monitoring by clicking the [Start] button.

The logging status of a monitoring target is displayed under "Logging status." When an error occurs, the error details screen appears by clicking the [...] button.

2. Click the [Stop] button to stop monitoring.

■ Starting or stopping the data logging

1. Specify the target memory (either data memory or SD memory card) where the effective setting data is stored. This can be selected only when all the logging statuses are "Stop."

2. Select the checkbox of the setting number to be executed. (Multiple selections allowed)

3. Start the data logging by clicking the [Start] button. (When multiple items are selected, they are executed simultaneously.)*¹

*1 The data logging can be registered with any of the following operations if "Operation at transition to RUN" is set to "Auto Start." (The data logging is registered again when any of the following operations is performed.)

- Powering OFF and ON
- Reset
- STOP→RUN

4. Click the [Pause] button to suspend the data logging, and the [Stop] button to stop the data logging. (When multiple items are selected, they are executed simultaneously.)

Point

- The data logging cannot be started even when writing the setting and powering OFF and ON or resetting the CPU module. Be sure to click the [Start] button to start the data logging (except for the auto logging).
- With regards to the trigger logging, the data logging setting registration attempt fails if the trigger condition is satisfied.
- It takes a certain time to stop or suspend the data logging after either of these commands is issued by CPU Module Logging Configuration Tool (because the data logging is not stopped or suspended unless the data stored in the internal buffer has been transferred into the SD memory card in response to these commands).
- There may be a case where a time-out error occurs and the logging is suspended after CPU Module Logging Configuration Tool starts the logging.

Precautions

When connecting to an MX Controller with enabled user authentication, the "User Authentication (PLC)" screen appears. A user name and password registered to the MX Controller need to be entered to log on.

User authentication can be enabled in GX Works3.

For details, refer to the following:

 GX Works3 Operating Manual

10 SAVING/DELETING DATA LOGGING FILES

This chapter shows the operation to save/delete data logging files in an SD memory card, the data memory, or function memory to/from a personal computer.

To perform this operation, a target CPU module needs to be set in the transfer setup in advance. (📖 Page 60 Transfer setup (MX Controller), 📖 Page 61 Transfer setup (RCPU))

Window

Select [Online] ⇒ [Logging File Operation].

Ex.

MX-R model

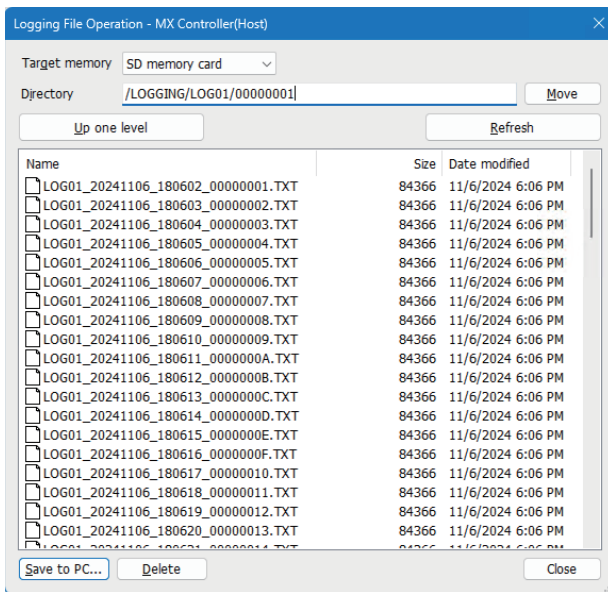

Operating procedure

1. Select the memory where the data to be operated is stored from "Target memory."
2. Specify the directory and select the target file.
3. To save the file, click the [Save to PC] button. To delete it, click the [Delete] button.

Point

- Only when the connection destination is set to an MX Controller, "Function memory" can be selected for "Target memory."
- Attempting the following operations may result in delay of other monitoring update because it takes time to save data logging files.
 - Saving a data logging file while the data logging function is being performed
 - Saving a large-volume Data logging file

Precautions

When connecting to an MX Controller with enabled user authentication, the "User Authentication (PLC)" screen appears.

A user name and password registered to the MX Controller need to be entered to log on.

User authentication can be enabled in GX Works3.

For details, refer to the following:

📖 GX Works3 Operating Manual

MEMO

11 CHECKING FILE TRANSFER STATUS OF DATA LOGGING FILES

This chapter shows the operations to check the file transfer status to the FTP server.

To perform this operation, a target CPU module needs to be set in the transfer setup in advance. (☞ Page 60 READING/ WRITING/DELETING LOGGING SETTINGS)

MX Controllers do not support this function.

Window

Select [Online] ⇒ [Data Logging File Transfer Status].

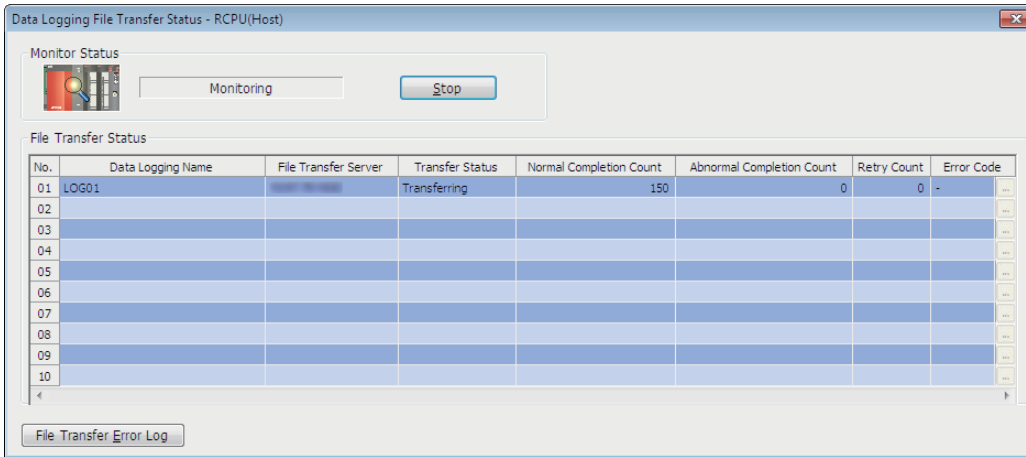

Displayed items

Item	Description	
[Start] (Stop) button	Click this to start monitoring while the monitoring stops and stop monitoring during the monitoring.	
File Transfer Status	No.	The data logging setting number is displayed.
	Data Logging Name	The data logging name is displayed.
	File Transfer Server	When the FTP server is specified with an IP address in the server setting, only the IP address is displayed. When the FTP server is specified with a server name, both of the IP address and server name are displayed.*1
	Transfer Status	The transfer status of the data logging file is displayed. <ul style="list-style-type: none"> —: The data logging file transfer setting is not set. Stopped: File transfer is stopped. Retrying: The file whose transfer failed is being transferred again. Transferring: Files are being transferred. Waiting for transfer: Files are waiting to be transferred, or there is no file to be transferred.
	Normal Completion Count	The number of data logging files that have been transferred to the FTP server is displayed.
	Abnormal Completion Count	The number of data logging files that have not been transferred to the FTP server is displayed.
	Retry Count	The number of retries is displayed.
	Error Code	The error code of the latest data logging file transfer function error is displayed. For details on error codes, refer to "List of Error Codes" in the manual for the CPU module used. (☞ RELEVANT MANUALS)
[...] button	This button is displayed when an error has occurred. Click this to display the error details screen.	
[File Transfer Error Log] button	Click this to display the error history screen. (☞ Page 70 File transfer error log)	

*1 When the FTP server is specified with the server name, the IP address is displayed in parentheses while the server is connected. Before the connection with the server is established, "—" is displayed in parentheses.

File transfer error log

The following screen is used to display the error history of the data logging file transfer function. Up to 20 errors are displayed. When the number of errors exceeds 20, logs are deleted in order from the oldest one. The error history is retained after the power is turned OFF and ON or the reset operation is performed.

Window

Click the [File Transfer Error Log] button in the "Data Logging File Transfer Status" screen.

Status	Date	Data Logging Setting No.	File Name	File Transfer Server	Error Code
Error	2017/11/08 16:24:52	01	LOG01_20171108_162451_00000014.TXT	192.168.1.100	4COBH
Error	2017/11/08 16:24:51	01	LOG01_20171108_162450_00000013.TXT	192.168.1.100	4COBH
Error	2017/11/08 16:24:51	01	LOG01_20171108_162450_00000012.TXT	192.168.1.100	4COBH
Error	2017/11/08 16:24:50	01	LOG01_20171108_162449_00000011.TXT	192.168.1.100	4COBH
Error	2017/11/08 16:24:50	01	LOG01_20171108_162449_00000010.TXT	192.168.1.100	4COBH
Error	2017/11/08 16:24:49	01	LOG01_20171108_162448_00000009.TXT	192.168.1.100	4COBH
Error	2017/11/08 16:24:48	01	LOG01_20171108_162448_00000008.TXT	192.168.1.100	4COBH
Error	2017/11/08 16:24:48	01	LOG01_20171108_162447_00000007.TXT	192.168.1.100	4COBH
Error	2017/11/08 16:24:47	01	LOG01_20171108_162446_00000006.TXT	192.168.1.100	4COBH
Error	2017/11/08 16:24:47	01	LOG01_20171108_162446_00000005.TXT	192.168.1.100	4COBH
Error	2017/11/08 16:24:46	01	LOG01_20171108_162445_00000004.TXT	192.168.1.100	4COBH
Error	2017/11/08 16:24:45	01	LOG01_20171108_162445_00000003.TXT	192.168.1.100	4COBH
Error	2017/11/08 16:24:45	01	LOG01_20171108_162444_00000002.TXT	192.168.1.100	4COBH
Error	2017/11/08 16:24:44	01	LOG01_20171108_162444_00000001.TXT	192.168.1.100	4COBH
Error	2017/11/08 16:24:44	01	LOG01_20171108_162443_00000000.TXT	192.168.1.100	4COBH
Error	2017/11/08 16:24:43	01	LOG01_20171108_162442_00000000.TXT	192.168.1.100	4COBH
Error	2017/11/08 16:24:43	01	LOG01_20171108_162442_00000000.TXT	192.168.1.100	4COBH
Error	2017/11/08 16:24:42	01	LOG01_20171108_162441_00000000.TXT	192.168.1.100	4COBH
Error	2017/11/08 16:24:41	01	LOG01_20171108_162441_00000000.TXT	192.168.1.100	4COBH
Error	2017/11/08 16:24:41	01	LOG01_20171108_162440_00000000.TXT	192.168.1.100	4COBH

Displayed items

Item	Description
Status	The file transfer status is displayed. • Error
Date	The date when the data logging file transfer function error occurred is displayed.
Data Logging Setting No.	The data logging setting number where the data logging file transfer function error has occurred is displayed.
File Name	The data logging file name where the data logging file transfer function error has occurred is displayed.*1
File Transfer Server	The IP address of the transfer destination server where the data logging file transfer function error has occurred is displayed.*2
Error Code	The data logging file transfer function error that has occurred is displayed. For details on error codes, refer to "List of Error Codes" in the manual for the CPU module used. (RELEVANT MANUALS)
[...] button	This button is displayed when an error has occurred. Click this to display the error details screen.
[Update] button	Click this to obtain the error history in a CPU module again and display it.
[Clear Log] button	Click this to clear the error history in a CPU module.

*1 When the data logging file transfer is stopped or there is no file to be transferred, "—" is displayed.

*2 Even when the FTP server is specified with the server name in the server setting, the IP address is displayed. However, when the server is not connected, "—" is displayed.

12 HELP OPERATIONS

This chapter shows the help function of CPU Module Logging Configuration Tool.

12.1 Opening Manual

e-Manual Viewer starts and the manual appears.

Operating procedure

Select [Help] ⇒ [Open Manual].

12.2 Connection to MITSUBISHI ELECTRIC FA Global Website

Access the Mitsubishi Electric FA website.

Operating procedure

Select [Help] ⇒ [Connection to MITSUBISHI ELECTRIC FA Global Website].

12.3 Version Information

Check the version of CPU Module Logging Configuration Tool.

Operating procedure

Select [Help] ⇒ [About Configuration tool].

MEMO

APPENDIX

Appendix 1 Additions and Changes from Previous Version

The following table shows the functions added and changed in CPU Module Logging Configuration Tool and the applicable software version.

Note that using the latest software version of CPU Module Logging Configuration Tool is recommended regardless of the added/changed.

SW1DNN-LLUTL-J (Japanese), SW1DNN-LLUTL-E (English), and SW1DNN-LLUTL-C (Chinese) are integrated into SW1DNN-LLUTL-M (Multiple languages) Version 1.46Y.

- SW1DNN-LLUTL-M (Multiple languages)

Item	Added/changed contents	Applicable software version
Display language switching	Display languages can be switched.	1.46Y or later
Supported CPU module	The following modules are supported in the data logging setting for an RCPU: <ul style="list-style-type: none"> • R08SFPCPU, R16SFPCPU, R32SFPCPU, R120SFPCPU • R04ENPCPU, R08ENPCPU, R16ENPCPU, R32ENPCPU, R120ENPCPU 	1.49B or later
Data logging setting (Sampling/data)	The following device can be specified in the data logging setting for an RCPU:*1 <ul style="list-style-type: none"> • BL□\S 	
Operating environment (operating system)	The following operating systems are supported. <ul style="list-style-type: none"> • German version • Italian version 	1.54G or later
Supported CPU module	The redundant mode of the following modules is supported in the data logging setting for an RCPU: <ul style="list-style-type: none"> • R08PCPU, R16PCPU, R32PCPU, R120PCPU 	1.58L or later
Operating environment (operating system)	Windows 10 (32-bit version and 64-bit version) is supported.	
Data logging setting (Data)	A device copied in another application can be pasted/inserted into the start device column in the "Data" setting screen.	1.70Y or later
Start from GX Works3	CPU Module Logging Configuration Tool can be started from GX Works3.	
Supported CPU module	The following modules are supported in the data logging setting for an RCPU: <ul style="list-style-type: none"> • R01CPU, R02CPU 	1.76E or later
Data logging setting (Logging type)	"CPU built-in memory (function memory)" can be selected in the "Logging type" setting screen in the data logging setting for an RCPU.*1	
Data logging setting (File transfer)	The setting to transfer a file to the FTP server is available in the data logging setting for an RCPU.*1	
Operating environment (operating system)	Windows 10 IoT Enterprise is supported.	1.82L or later
Data logging setting (Sampling/data)	Local devices can be specified in the data logging setting for an RCPU.*1	
Reading a GX Works3 project	A GX Works3 project whose module type is an RnCPU or RnENPCPU can be read, and labels can be specified.	
Data logging setting (Sampling/data/trigger)		
Data logging setting (Sampling/data)	Link direct devices whose points are greater than the following range can be specified in the data logging setting for an RCPU.*1 <ul style="list-style-type: none"> • J□\SB/J□\SW: 512 points, J□\X/J□\Y: 16K points, J□\B: 32K points, J□\W: 128K points 	1.100E or later
Data logging setting (Logging type)	"CSV file" can be selected in the "Logging type" setting screen in the data logging setting for an RCPU.*1	1.112R or later
Operating environment (operating system)	Windows XP® and Windows Vista® are no longer supported.	
Data logging setting (Data)	"Insert Copied Setting Item" and "Insert Cut Setting Item" are changed to "Insert and Paste Setting Item."	1.118X or later
	A data logging setting item can be pasted into another data logging setting.	
Operating environment (operating system)	Windows 11 is supported.	1.130L or later

Item	Added/changed contents	Applicable software version
Operating environment (operating system)	Windows 7, Windows 8, and Windows 8.1 are no longer supported.	1.142Y or later
Others	MELSOFT Update Manager is supported.	
Specifying a connection destination	A personal computer and an RCPUs can be connected via a GOT (GOT transparent function). (Only Ethernet or USB connection for the GOT2000 series is supported.)	
Reading a GX Works3 project	A GX Works3 project whose security version is '2' can be read.	1.154L or later
Data logging setting (Logging type/data)	Both devices and labels can be set as a logging target of one data logging setting by selecting the checkbox of "Label can also be specified in logging target" in the "Logging type" setting screen in the data logging setting for an RCPUs. ^{*1}	
Start from GX Works3	Information of a device/label selected in a GX Works3 project whose module type is an RnCPU or RnENCPU can be registered to the "Data" setting screen automatically when starting CPU Module Logging Configuration Tool from GX Works3.	
Opening this manual	This manual appears by selecting the following menu: • [Help] ⇒ [Open Manual]	
Reading a GX Works3 project	A GX Works3 project whose module type is a safety CPU can be read, and labels can be specified.	1.160S or later
Data logging setting (Sampling/data/trigger)		
Start from GX Works3	Information of a device/label selected in a GX Works3 project whose module type is a safety CPU can be registered to the "Data" setting screen automatically when starting CPU Module Logging Configuration Tool from GX Works3.	
Supported CPU module	The following modules are supported in the data logging setting for an MX Controller: • MXR300-16, MXR300-32, MXR300-64, MXR500-128, MXR500-256 • MXF100-8-N32, MXF100-8-P32, MXF100-16-N32, MXF100-16-P32	1.166Y or later
Data logging setting (Sampling/data/trigger)	Label name options are displayed in the data logging setting for an RCPUs.	

*1 To use this function, it is required that the firmware of a CPU module supports the function. For information on the firmware versions, refer to "Added and Enhanced Functions" in the manual for the CPU module used.

☞ RELEVANT MANUALS

- SW1DNN-LLUTL-J (Japanese)

Added/changed contents	Applicable software version
MELSEC iQ-R series CPU modules (R04CPU, R08CPU, R16CPU, R32CPU, and R120CPU) are supported.	1.35M
The realtime monitor function of RCPUs is supported.	1.40S
MELSEC iQ-R series process CPU modules (R08PCPU, R16PCPU, R32PCPU, and R120PCPU) are supported.	1.43V

- SW1DNN-LLUTL-E (English)

Added/changed contents	Applicable software version
MELSEC iQ-R series CPU modules (R04CPU, R08CPU, R16CPU, R32CPU, and R120CPU) are supported.	1.35M
The realtime monitor function of RCPUs is supported.	1.40S
MELSEC iQ-R series process CPU modules (R08PCPU, R16PCPU, R32PCPU, and R120PCPU) are supported.	1.43V

Appendix 2 Version Compatibility

This section shows the software versions of CPU Module Logging Configuration Tool and each MELSOFT product that must be installed to link between CPU Module Logging Configuration Tool and the MELSOFT product.

Starting CPU Module Logging Configuration Tool from GX Works3

The following table shows the software versions of CPU Module Logging Configuration Tool and GX Works3 that must be installed to start CPU Module Logging Configuration Tool from GX Works3.

Module type	CPU Module Logging Configuration Tool	GX Works3
MX Controller	1.166Y or later	1.115V or later
RnCPU	1.70Y or later	1.035M or later
RnENCPU		
Process CPU		
Safety CPU		

The following table shows the software versions of CPU Module Logging Configuration Tool and GX Works3 that must be installed to register devices/labels in the "Data" setting screen automatically.

Module type	CPU Module Logging Configuration Tool	GX Works3
MX Controller	1.166Y or later	1.115V or later
RnCPU	1.154L or later	1.105K or later
RnENCPU		
Safety CPU	1.160S or later	1.110Q or later

For the procedure to start CPU Module Logging Configuration Tool from GX Works3, refer to the following:

 Page 17 Start

Starting GX LogViewer from CPU Module Logging Configuration Tool

The following table shows the software versions of CPU Module Logging Configuration Tool and GX LogViewer that must be installed to start GX LogViewer from CPU Module Logging Configuration Tool and to start the realtime monitor function. This function is available only when connecting to an MX Controller.

Module type	CPU Module Logging Configuration Tool	GX LogViewer
MX Controller	1.166Y or later	1.115V or later

For the procedure to start the realtime monitor function of GX LogViewer from CPU Module Logging Configuration Tool, refer to the following:

 Page 25 Logging setting list screen

Appendix 3 Supported Characters

This section shows the supported characters.

Supported characters for CPU Module Logging Configuration Tool

Any characters that can be expressed by Unicode are supported. However, the supported characters vary for each position as shown in the following table. Note that if attempting to input an unsupported character, the entry is rejected or a message screen appears in response to the improper entry.

Place where character is used		Support status of the target character																		
		(SP) ^{*1}	"	'	*	+	,	/	:	;	<	>	?	[\]		.	Double-byte character	
Data Logging Setting	<ul style="list-style-type: none"> Data Logging Name String for Indicating Trigger Occurrence Comment 	○	×	○	○	○	×	○	○	×	○	○	○	○	○	○	○	○	○	○
	Date Line Output Format	○	×	○	○	○	×	○	○	×	○	○	○	○	○	○	○	○	○	×
"Logging File Operation" screen	Directory	×	×	○	×	○	×	○	×	×	×	×	○	×	○	×	×	×	×	×

*1 (SP) means a space.



Surrogate pair characters cannot be used.

Supported characters for the file name and the folder (directory) name

Characters in the shaded area can be used.

	0	1	2	3	4	5	6	7	8	9
0	NULL		(SP)	0	@	P	`	p		
1			!	1	A	Q	a	q		
2			"	2	B	R	b	r		
3			#	3	C	S	c	s		
4			\$	4	D	T	d	t		
5			%	5	E	U	e	u		
6			&	6	F	V	f	v		
7			'	7	G	W	g	w		
8			(8	H	X	h	x		
9)	9	I	Y	i	y		
A			*	:	J	Z	j	z		
B			+	;	K	[k	{		
C			,	<	L	\	l			
D			-	=	M]	m	}		
E			.	>	N	^	n	~		
F			/	?	O	_	o			

Appendix 4 USB Driver Installation Procedure

To communicate with a CPU module via USB, installing a USB driver is required.

Operating procedure

1. Connect a personal computer and a CPU module with a USB cable, and turn the power of the programmable controller ON.
2. Right-click "Unknown Device" and click "Update driver" in Windows Device Manager.
3. Select "Browse my computer for drivers" in the "Update Drivers" screen, and specify 'Easysocket\USBDrivers' in the folder where CPU Module Logging Configuration Tool is installed on the next screen.

When an installation folder is not changed at the installation, the installation folder is as follows:

- 64-bit version operating system: C:\Program Files (x86)\MELSOFT\Easysocket\USBDrivers
- 32-bit version operating system: C:\Program Files\MELSOFT\Easysocket\USBDrivers

If multiple MELSOFT products are already installed, specify 'Easysocket\USBDrivers' which is in the folder of the first product installed.

If 'Easysocket\USBDrivers' does not exist, search for 'USBDrivers' in the Windows explorer.

MEMO

REVISIONS

*The manual number is given on the bottom left of the back cover.

Revision date	*Manual number	Description
July 2022	SH(NA)-082478ENG-A	First edition (Due to the revision of 'MELSEC iQ-R CPU Module User's Manual (Application),' the descriptions for CPU Module Logging Configuration Tool have been separated.)
April 2023	SH(NA)-082478ENG-B	■Added or modified parts Section 2.2, Section 5.6, Chapter 8, Appendix 1
April 2024	SH(NA)-082478ENG-C	■Added or modified parts TERM, GENERIC TERMS AND ABBREVIATIONS, Section 3.3, Section 5.6, Section 6.1, Section 6.2, Section 6.3, Section 6.4, Section 6.5, Section 6.6, Section 6.7, Section 6.8, Section 6.9, Section 6.10, Section 7.1, Appendix 1, Appendix 2
October 2024	SH(NA)-082478ENG-D	■Added or modified parts Section 3.3, Section 5.6, Section 6.4, Section 6.5, Appendix 1, Appendix 2
April 2025	SH(NA)-082478ENG-E	■Added or modified parts RELEVANT MANUALS, GENERIC TERMS AND ABBREVIATIONS, Chapter 1, Section 2.2, Section 4.1, Section 4.2, Section 5.1, Section 6.1, Chapter 7, Chapter 8, Section 8.1, Section 8.2, Section 8.3, Chapter 9, Chapter 10, Chapter 11, Appendix 1, Appendix 2

Japanese manual number: SH-082477-E

This manual confers no industrial property rights or any rights of any other kind, nor does it confer any patent licenses. Mitsubishi Electric Corporation cannot be held responsible for any problems involving industrial property rights which may occur as a result of using the contents noted in this manual.

© 2022 MITSUBISHI ELECTRIC CORPORATION

INFORMATION AND SERVICES

For further information and services, please contact your local Mitsubishi Electric sales office or representative.
Visit our website to find our locations worldwide.

MITSUBISHI ELECTRIC Factory Automation Global Website
Locations Worldwide
www.MitsubishiElectric.com/fa/about-us/overseas/

TRADEMARKS

Unicode is either a registered trademark or a trademark of Unicode, Inc. in the United States and other countries.
Windows, Windows Vista, and Windows XP are trademarks of the Microsoft group of companies.
The company names, system names and product names mentioned in this manual are either registered trademarks or trademarks of their respective companies.
In some cases, trademark symbols such as [™] or [®] are not specified in this manual.

SH(NA)-082478ENG-E(2504)

MODEL: SW1DNN-LLUTL-O-E

mitsubishi electric corporation

HEAD OFFICE: TOKYO BLDG., 2-7-3, MARUNOUCHI, CHIYODA-KU, TOKYO 100-8310, JAPAN
NAGOYA WORKS: 1-14, YADA-MINAMI 5-CHOME, HIGASHI-KU, NAGOYA 461-8670, JAPAN

When exported from Japan, this manual does not require application to the
Ministry of Economy, Trade and Industry for service transaction permission.

Specifications subject to change without notice.