

MITSUBISHI ELECTRIC

GT25 Open Frame Model

General Description

GT2512F-STNA GT2512F-STND GT2510F-VTNA GT2510F-VTND
GT2508F-VTNA GT2508F-VTND

Thank you for choosing Mitsubishi Electric Graphic Operation Terminal (GOT).

Prior to use, please read both this manual and the detailed manual thoroughly to fully understand the product.

MODEL	GT25F-U-GD-E
Model code	1D7MQ5
IB(NA)-0800553ENG-E(2008)MEE	

© 2015 MITSUBISHI ELECTRIC CORPORATION

SAFETY PRECAUTIONS

(Always read these precautions before using this equipment.) Before using this product, please read this manual and the relevant manuals introduced in this manual carefully and pay full attention to safety to handle the product correctly.

The precautions given in this manual are concerned with this product. In this manual, the safety precautions are ranked as "WARNING" and "CAUTION".

WARNING Indicates that incorrect handling may cause hazardous conditions, resulting in death or severe injury.

CAUTION Indicates that incorrect handling may cause hazardous conditions, resulting in medium or slight personal injury or physical damage.

Note that the CAUTION level may lead to a serious accident according to the circumstances. Always follow the instructions of both levels because they are important to personal safety. Please save this manual to make it accessible when required and always forward it to the end user.

DESIGN PRECAUTIONS

WARNING

- Some failures of the GOT, communication unit or cable may keep the outputs on or off.
- Some failures of a touch panel may cause malfunction of the input objects such as a touch switch.
- An external monitoring circuit should be provided to check for output signals which may lead to a serious accident.
- Not doing so can cause an accident due to false output or malfunction.
- Do not use the GOT as the warning device that may cause a serious accident. An independent and redundant hardware or mechanical interlock is required to configure the device that displays and outputs serious warning.
- Failure to observe this instruction may result in an accident due to incorrect output or malfunction.
- The GOT backlight failure disables the operation on the touch switch(s).
- When the GOT backlight has a failure, the POWER LED blinks (orange/blue) and the display section dims.
- In such a case, the input by the touch switch(s) is disabled.
- The display section of the GOT is an analog-resistive type touch panel. Do not touch two points or more simultaneously on the display section. Doing so may cause a touch switch near the touched points to operate unexpectedly, or may cause an accident due to an incorrect output or malfunction.
- When programs or parameters of the controller (such as a PLC) that is monitored by the GOT are changed, be sure to reset the GOT, or turn on the unit again after shutting off the power as soon as possible.
- Not doing so can cause an accident due to false output or malfunction.
- If a communication fault (including cable disconnection) occurs during monitoring on the GOT, communication between the GOT and PLC CPU is suspended and the GOT becomes inoperative.
- For bus connection: The PLC CPU becomes faulty and the GOT becomes inoperative.
- For other than bus connection: The GOT becomes inoperative.
- A system where the GOT is used should be configured to perform any significant operation to the system by using the switches of a device other than the GOT on the assumption that a GOT communication fault will occur. Not doing so can cause an accident due to false output or malfunction.
- To maintain the security (confidentiality, integrity, and availability) of the GOT and the system against unauthorized access, DoS attacks, computer viruses, and other cyberattacks from unreliable networks and devices via network, take appropriate measures such as firewalls, virtual private networks (VPNs), and antivirus solutions.
- Mitsubishi Electric shall have no responsibility or liability for any problems involving GOT trouble and system trouble by DoS attacks, unauthorized access, computer viruses, and other cyberattacks.
- *1 DoS: A denial-of-service (DoS) attack disrupts services by overloading systems or exploiting vulnerabilities, resulting in a denial-of-service (DoS) state.

WARNING

- Products with the C.I. DIV2 mark on the rating plate are suitable for use in Class I, Division 2, Groups A, B, C and D hazardous locations, or nonhazardous locations only.
- This mark indicates that the product is certified for use in the Class I, Division 2 environment where flammable gases, vapors, or liquids are not likely to exist under normal conditions.
- When using the products in the Class I, Division 2 environment, observe the following to reduce the risk of explosion.
 - This device is open-type and is to be installed in an enclosure suitable for the environment and require a tool or key to open.
 - Warning - Explosion Hazard - Substitution of any component may impair suitability for Class I, Division 2.
 - Warning - Explosion Hazard - Do not connect or disconnect equipment or disconnect external connection terminals unless power has been removed or the area is known to be non-hazardous.
 - The side interface and extension interface of this equipment cannot be used in Class I, Division 2 environments.
 - Les produits marqués C.I. DIV2 sur la plaque signalétique peuvent être utilisés en Class I, Division 2, local dangereux de groupe A, B, C et D, ou uniquement en local non dangereux.
 - Ce logo indique que le produit est homologué pour utilisation en environnement de Class I, Division 2, dans des circonstances anormales, il peut y avoir présence de gaz, vapeurs ou liquides inflammables.
 - Si le produit est utilisé en environnement de Class I, Division 2, observer les précautions suivantes pour réduire le risque d'explosion.
 - Cet appareil est de type ouvert et il doit être installé dans une enceinte appropriée à l'environnement et ne pouvant être ouverte qu'au moyen d'un clé ou d'un outil.
 - Avertissement - Danger d'explosion - Toute substitution de composant peut compromettre l'aptitude à l'utilisation en Class I, Division 2.
 - Avertissement - Danger d'explosion - Ne pas connecter ou déconnecter l'équipement ni déconnecter les bornes de connexion externes quand le circuit est sous tension, ni avant de s'être assuré de l'absence d'atmosphère inflammable.
 - L'interface latérale et l'interface d'extension de cet équipement ne peuvent être utilisées dans les environnements de Classe I, Division 2.

CAUTION

- Do not bundle the control and communication cables with main-circuit, power or other wiring.
- Run the above cables separately from such wiring and keep them a minimum of 100mm apart.
- Do not do so can cause a malfunction.
- Do not press the GOT display section with a pointed material as a pen or driver.
- Doing so can result in a damage or failure of the display section.
- When the GOT connects to an Ethernet network, the IP address setting is restricted according to the system configuration.
- When a GOT2000 series model and a GOT1000 series model are on an Ethernet network, do not set the IP address 192.168.0.18 for the GOTs and the controllers on this network.
- Doing so can cause an IP address duplication at the GOT startup, adversely affecting the communication of the device with the IP address 192.168.0.18. The operation at the IP address duplication depends on the devices and the system.
- Turn on the controllers and the network devices to be ready for communication before they communicate with the GOT.
- Failure to do so can cause a communication error on the GOT.
- When the GOT is subjected to shock or vibration, or some colors appear on the screen of the GOT, the screen of the GOT might flicker.

MOUNTING PRECAUTIONS

WARNING

- Be sure to shut off all phases of the external power supply used by the system before mounting or removing the GOT main unit to/from the panel. Not doing so can cause the unit to fail or malfunction.
- Be sure to shut off all phases of the external power supply used by the system before mounting or removing the communication unit or the option unit on/from the GOT.

CAUTION

- Use the GOT in the environment that satisfies the general specifications described in this manual. Not doing so can cause an electric shock, fire, malfunction or product damage or deterioration.
- When mounting a unit on the GOT, tighten the mounting screws in the following specified torque range. When loading the communication unit or option unit other than wireless LAN unit to the GOT, fit it to the connection interface of the GOT and tighten the mounting screws in the specified torque range (0.36 N·m to 0.48 N·m) with a Phillips-head screwdriver No. 2.
- When loading the wireless LAN unit to the GOT, fit it to the side interface of GOT and tighten the mounting screws in the specified torque range (0.10 N·m to 0.14 N·m) with a Phillips-head screwdriver No. 1.
- When the GOT is installed vertically, its side interface is positioned on the bottom. To prevent the falling of the wireless LAN communication unit from the side interface, install or remove the unit while holding it with hands.
- Under tightening can cause the GOT to drop, failure or malfunction.
- Overtightening can cause a drop, failure or malfunction due to the damage of the screws or unit.
- Remove the protective film of the GOT.
- When the user continues using the GOT with the protective film, the film may not be removed.
- Attach an environmental protection sheet dedicated to the open frame model (sold separately) to the display section of GOT.
- Or, attach a user-prepared environmental protection sheet.
- Not doing so may damage or soil the GOT or cause foreign matter to enter the GOT, resulting in a failure or malfunction.
- When installing the supplied fittings, tighten screws in the specified torque range (0.8 N·m to 1.0 N·m).
- Melt studs on the control panel to fasten the fittings.
- The studs must have strength adequate to withstand a tightening torque of 0.9 N·m or more.
- Make sure that no foreign matter such as welding waste is at and around the bases of the studs.
- Tighten nuts on the studs in the specified torque range (0.8 N·m to 0.9 N·m) with a wrench for M4 nuts.
- Under tightening a screw or nut may cause the GOT to drop, short-circuit, or malfunction.
- Overtightening a screw or nut may damage it or the GOT, causing the GOT to drop, short-circuit, or malfunction.
- Do not operate or store the GOT in the environment exposed to direct sunlight, high temperature, dust, humidity, or vibrations.

WIRING PRECAUTIONS

WARNING

- Be sure to shut off all phases of the external power supply used by the system before wiring.
- Failure to do so may result in an electric shock, product damage or malfunctions.

CAUTION

- Make sure to ground the FG terminal and LG terminal of the GOT power supply section solely for the GOT (ground resistance: 100 Ω or less, ground cable diameter: 1.6 mm or more).
- Not doing so may cause an electric shock or malfunction.
- Do not touch the terminal screws, use a Phillips-head screwdriver No. 2.
- Terminal screws which are not to be used must be tightened always at torque 0.5 N·m to 0.8 N·m.
- Otherwise there will be a danger of short circuit against the solderless terminals.
- Use applicable solderless terminals and tighten them with the specified torque. If any solderless spade terminal is used, it may be disconnected when the terminal screw comes loose, resulting in failure.
- Correctly wire the GOT power supply section after confirming the rated voltage and terminal arrangement of the product.
- Not doing so can cause a fire or failure.
- Tighten the terminal screws of the GOT power supply section in the specified torque range (0.5 N·m to 0.8 N·m). Under tightening can cause a short circuit or malfunction. Overtightening can cause a short circuit or malfunction due to the damage of the screws or the unit.
- Exercise care to avoid foreign matter such as chips and wire offcuts entering the GOT.
- Not doing so can cause a fire, failure or malfunction.
- The module has an ingress prevention label on its top to prevent foreign matter, such as wire offcuts, from entering the module during wiring.
- Before starting system operation, be sure to peel this label because of heat dissipation.
- Plug the communication cable into the GOT interface or the connector of the connected unit solely for the GOT (ground resistance: 100 Ω or less, ground cable diameter: 1.6 mm or more).
- Under tightening can cause a short circuit or malfunction.
- Overtightening can cause a short circuit or malfunction due to the damage of the screws or unit.
- Plug the QnA/ACP/Motion controller (A series) bus connection cable by inserting it into the connector of the connected unit until it "clicks".
- After plugging, check that it has been inserted snugly.
- Not doing so can cause a malfunction due to a contact fault.

TEST OPERATION PRECAUTIONS

WARNING

- Before testing the operation of a user-created monitor screen (such as turning on or off a bit device, changing the current value of a word device, changing the set value or current value of a timer or counter, and changing the current value of a buffer memory), thoroughly read the manual to fully understand the operating procedure.
- During the test operation, never change the data of the devices which are used to perform significant operation for the system.
- Failure to do so may cause a malfunction or cause an accident.

STARTUP/MAINTENANCE PRECAUTIONS

WARNING

- When power is on, do not touch the terminals.
- Doing so can cause an electric shock, fire, or failure.
- Correctly connect the battery connector.
- Do not charge, disassemble, heat, short-circuit, solder, or throw the battery into the fire.
- Doing so will cause the battery to produce heat, explode, or ignite, resulting in injury and fire.
- Before starting cleaning or terminal screw retightening, always switch off the power externally in all phases. Not switching the power off in all phases can cause a unit failure or malfunction.
- Under tightening can cause a drop, short circuit or malfunction.
- Overtightening can cause a drop, short circuit or malfunction due to the damage of the screws or unit.

CAUTION

- Do not disassemble or modify the unit.
- Doing so can cause a failure, malfunction, injury or fire.
- Do not touch the conductive and electronic parts of the unit directly.
- Doing so can cause a failure or malfunction.
- The cables connected to the unit must be run in ducts or clamped.
- Not doing so can cause the unit or cable to be damaged due to the dangling, motion or accidental pulling of the cables or can cause a malfunction due to a cable connection fault.
- When unplugging the cable connected to the unit, do not hold and pull from the cable portion.
- Doing so can cause the unit or cable to be damaged or can cause a malfunction due to a cable connection fault.
- Do not drop the module or subject it to strong shock. A module damage may result.
- Do not drop or give an impact to the battery mounted to the unit.
- Doing so may damage the battery, causing the battery fluid to leak inside the battery.
- If the battery is dropped or given an impact, dispose of it without using.
- Before touching the unit, always touch grounded metals, etc. to discharge static electricity from human body, etc.
- Dispose of used battery promptly.
- Keep away from children. Do not disassemble and do not dispose of in fire.
- Be sure to shut off all phases of the external power supply before replacing the battery or using the dip switch of the terminating resistor.
- Not doing so can cause the unit to fail or malfunction by static electricity.

TOUCH PANEL PRECAUTIONS

CAUTION

- For the analog-resistive film type touch panels, normally the adjustment is not required.
- However, the difference between a touched position and the object position may occur as the period of use elapses.
- When any difference between a touched position and the object position occurs, execute the touch panel calibration.

CAUTION

- When any difference between a touched position and the object position occurs, other object may be activated.
- This may cause an unexpected operation due to incorrect output or malfunction.

PRECAUTIONS WHEN THE DATA STORAGE IS IN USE

WARNING

- If the SD card is removed from drive A of the GOT while being accessed by the GOT, the GOT may stop processing data for about 20 seconds.
- The GOT cannot be operated during this period.
- The functions that run in the background including a screen updating, alarm, logging, scripts, and others are also interrupted.
- Since this interruption makes an impact to the system operation, it might cause failure.
- Check that the SD card access LED is off before removing the SD card.

CAUTION

- If the data storage is removed from the GOT while being accessed by the GOT, the data storage and files may be damaged.
- Before removing the data storage from the GOT, check the SD card access LED, system signal, or others to make sure that the data storage is not accessed.
- Turning off the GOT while it accesses the SD card results in damage to the SD card and files.
- After inserting an SD card into the GOT, make sure to close the SD card cover. Not doing so causes the data not to be read or written.
- When removing the SD card from the GOT, make sure to support the SD card by hand as it may pop out.
- Not doing so may cause the SD card to drop from the GOT, resulting in a failure or break.
- When inserting a USB device into a USB interface of the GOT, make sure to insert the device into the interface firmly.
- Not doing so can cause a malfunction due to a contact failure.
- Before removing the data storage from the GOT, follow the procedure for removal on the utility screen of the GOT.
- After the successful completion dialog is displayed, remove the data storage by hand carefully.
- Not doing so may cause the data storage to drop from the GOT, resulting in a failure or break.

PRECAUTIONS FOR USE

CAUTION

- Do not touch the outer edge of the actual display area repeatedly.
- Doing so may result in a failure.
- Do not turn off the GOT while data is being written to the storage memory (ROM) or SD card.
- Doing so may corrupt the data, rendering the GOT inoperative.

PRECAUTIONS FOR REMOTE CONTROL

WARNING

- Remote control is available through a network by using GOT functions, including the SoftGOT-GOT link function, the remote personal computer operation function, the VNC server function, and the GOT Mobile function.
- If these functions are used to perform remote control of control equipment, the field operator may not notice the remote control, possibly leading to an accident.
- In addition, a communication delay or interruption may occur depending on the network environment, and remote control of control equipment cannot be performed normally in some cases.
- Before using the above functions to perform remote control, fully grasp the circumstances of the field site and ensure safety.

PRECAUTIONS FOR EXCLUSIVE AUTHORIZATION CONTROL

WARNING

- Make sure to fully understand the GOT network interaction function before using this function to control the authorization among pieces of equipment to prevent simultaneous operations.
- The exclusive authorization control of the GOT network interaction function can be enabled or disabled for each screen.
- (For all screens, the exclusive authorization control is disabled by default.)
- Properly determine the screens for which the exclusive authorization control is required, and set the control by screen.
- A screen for which the exclusive authorization control is disabled can be operated simultaneously from pieces of equipment.
- Make sure to determine the operation period for each operator, fully grasp the circumstances of the field site, and ensure safety to perform operations.

DISPOSAL PRECAUTIONS

CAUTION

- When disposing of this product, treat it as industrial waste.
- When disposing of batteries, separate them from other wastes according to the local regulations.
- (Refer to the GOT2000 Series User's Manual (Hardware) for details of the battery directive in the EU member states.)

TRANSPORTATION PRECAUTIONS

CAUTION

- When transporting lithium batteries, make sure to treat them based on the transport regulations.
- (Refer to the GOT2000 Series User's Manual (Hardware) for details of the regulated models.)
- Make sure to transport the GOT main unit and/or relevant unit(s) in the manner they will not be exposed to the impact exceeding the impact resistance described in the general specifications of this manual, as they are precision devices.
- Failure to do so may cause the unit to fail.
- Check if the unit operates correctly after transportation.
- When fumigants that contain halogen materials such as fluorine, chlorine, bromine, and iodine are used for disinfecting and protecting wooden packaging from insects, they cause malfunction when entering our products.
- Please take necessary precautions to ensure that remaining materials from fumigant do not enter our products, or treat packaging with methods other than fumigation (heat method).
- Additionally, disinfect and protect wood from insects before packing products.

Manuals

The following shows manuals relevant to this product.

Manual name	Manual number (Model code)
GOT2000 Series User's Manual (Hardware)	SH-081194ENG (1D7MJ5)
GOT2000 Series User's Manual (Utility)	SH-081195ENG (1D7MJ6)

For detailed manuals and relevant manuals, refer to the e-Manual or PDF manuals stored in the DVD-ROM for the screen design software or PDF.

The latest manuals are also available from MITSUBISHI ELECTRIC FA Global Website (www.MitsubishiElectric.com/ifa).

Compliance with the new China RoHS directive

GOT 相关的基于“电器电子产品有害物质限制使用管理办法”要求的表示方法

15 Note: This symbol mark is for China only.

含有害6物质的名称、含有量、含有部件
本产品中所含有的有害6物质的名称、含有量、含有部件如下表所示。
产品中有害物质的名称及含量

部件名称	有害物质					
	铅 (Pb)	汞 (Hg)	镉 (Cd)	六价铬 (Cr(VI))	多溴联苯 (PBB)	多溴二苯醚 (PBDE)
电路板组件	×	○	○	○	○	○
树脂壳体、电缆、膜材	○	○	○	○	○	○
钣金部件、螺丝等金属部件	×	○	○	○	○	○

本表格依据 SJ/T11364 的规定编制。
○：表示该有害物质在该部件所有均质材料中的含量均在 GB/T26572 规定的限量要求以下。
×：表示该有害物质至少在该部件的某一均质材料中的含量超出 GB/T26572 规定的限量要求。

Referenced Standard: GB/T15969.2 (Requirement of Chinese standardized law)

Before using the GOT

Connect the connector of the GOT to the connector of the battery. Refer to the GOT2000 Series User's Manual (Hardware) for the connection instructions.

For details on the GOT specifications, installing instructions, wiring, maintenance and inspection, or checking procedure for the version and the compatible standard, refer to the GOT2000 Series User's Manual (Hardware).

Packing List

The GOT product package includes the following:

Description	Quantity
GT25	1
Battery (GT11-50BAT) (Attached to the GOT)	1
Fitting (for fixing the GOT to the control panel)	2 (for fixing the top and bottom of the GOT) 2 (for fixing the right and left of the GOT)
Screw (for fixing the fitting to the GOT)	6
Nut (for fixing the fitting to the control panel)	6
GT25 Open Frame Model General Description (This manual)	1

To mount the GOT, studs are necessary on the control panel. You are required to prepare the studs.

Align the studs with the installation holes of the fittings, and install the studs. The control panel requires a thickness of 1.5 mm to 4 mm.

Attach the environmental protection sheet dedicated to the open frame model (sold separately) to the GOT display section. Or, attach a user-prepared environmental protection sheet. Not doing so may damage or soil the GOT or cause foreign matter to enter the GOT, resulting in a failure or malfunction.

- 1. FEATURES**
- Abundant standard equipment
 - Variety of connection with FA devices
 - SD card interface compatible with the SDHC card having a large capacity and allowing high-speed communication
 - Connection with various peripheral devices with the USB host
 - Improved usability
 - Abundant troubleshooting
 - Easy and clear screen creation
 - PC-like operation screen
 - Support for the vertical installation
 - Enhanced compatibility with Mitsubishi Electric FA devices
 - LED backlight
 - Various extended functions supported
 - Improved usability
 - The GOT front face and the control panel surface are in the same plane.

2. PARTS NAMES AND SETTINGS

The following shows the parts names for GT2512F-S, GT2510F-V and GT2508F-V.

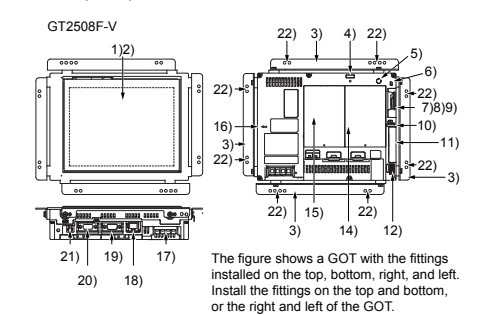
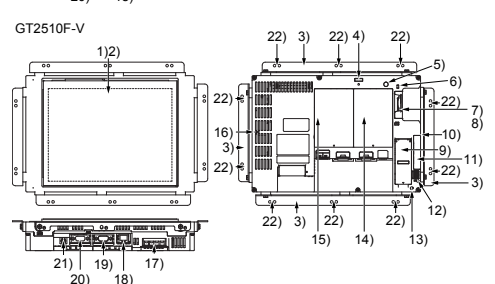
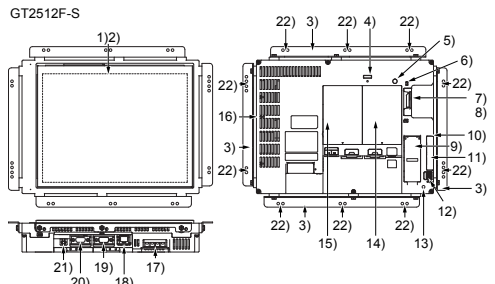

No.	Name	Description
1)	Display screen	Displays the utility and the user-created screen.
2)	Touch Pane	For operating the touch switches in the utility and the user-created screen
3)	Unit installation fitting	Mounting fixtures for fixing the GOT to the control panel
4)	Reset switch	Hardware reset switch
5)	Installation switch	Used for OS installations at the GOT startup
6)	SD card access LED	Lit: SD card mounted Blinking: SD card accessed No lit: SD card not mounted or SD card mounted (removable)
7)	SD card interface	For installing a SD card
8)	SD card cover	With a switching function for accepting and stopping the access to the SD card When the cover is opened: Access is prohibited When the cover is closed: Access is allowed
9)	Battery holder	Houses the battery Lit in blue: Power is properly supplied. Lit in orange: Screen saving Lit in orange/blue: Backlight failure No lit: Power is not supplied (You can check the LED status from the GOT rear face.)
11)	Side interface	For installing a communication unit
12)	USB interface (Host/Back face)	For connecting a USB mouse, a USB keyboard, or a USB barcode reader, and transferring or saving data (Connector shape: TYPE-A)
13)	Hole for attaching a cable clamp	Hole for attaching a cable clamp for preventing USB cable from being pulled out (Recommended product: SKB-132PWD of SK KOHKI CO., LTD. or corresponding product)

No.	Name	Description
14)	Terminating resistor setting switch (Inside cover)	For switching on and off of the terminating resistor for the RS-422/485 communication port (Default: OFF)
15)	Extension interface	For installing a communication unit or an option unit
16)	Vertical installation arrow mark	For the vertical installation, install the GOT so that the arrow points upward.
17)	Power terminal	Power input terminal, LG terminal, FG terminal
18)	Ethernet interface	For communicating with a controller or connecting a personal computer (Connector shape: RJ-45 (modular jack))
19)	RS-232 interface	For communicating with a controller (Connector shape: D sub 9-pin (male))
20)	RS-422/485 interface	For communicating with a controller (Connector shape: D sub 9-pin (female))
21)	USB interface (Device/Back face)	For connecting personal computers (Connector shape: Mini-B) (Only GT2510-VTWA/D, GT2508-VTWA/D)
22)	Fitting installation hole	For fixing the fitting to the control panel.

3. SPECIFICATIONS

3.1 General Specifications

Item	Specifications
Operating ambient temperature ¹⁾ Température ambiante de fonctionnement ¹⁾	0 to 55°C ²⁾ 0 à 55°C ²⁾
Storage ambient temperature	-20 to 60°C
Operating ambient humidity	10 to 90% RH, non-condensing
Storage ambient humidity	10 to 90% RH, non-condensing
Vibration resistance	Compliant with JIS B 3502 and 61131-2 Under intermittent vibration 5 to 8.4Hz 8.4 to 150Hz 9.8m/s ² - 3.5mm 10 times each in X, Y and Z directions
Shock resistance	Compliant with JIS B 3502 and IEC 61131-2 147 mis ² (15G), 3 times each in X, Y and Z directions
Operating atmosphere	No greasy fumes, corrosive gas, flammable gas, excessive conductive dust, and direct sunlight (Same as storage atmosphere)
Operating altitude ³⁾	2000 m (6562 ft) max.
Installation location	Inside control panel
Overvoltage category	II or less
Pollution degree ⁵⁾	2 or less
Cooling method	Self-cooling
Grounding	Grounding with a ground resistance of 100 Ω or less by using a ground cable that has a cross-sectional area of 2 mm ² or more. If possible, connect the ground cable to the control panel.

- The operating ambient temperature includes the temperature inside the enclosure of the control panel to which the GOT is installed. La température ambiante de fonctionnement inclut la température à l'intérieur du boîtier du tableau de commande sur lequel le GOT est installé.
- When mounting a MELSECNET/II communication unit (GT15-J71LP23-25, GT15-J71BR13), or CC-Link communication unit (GT15-J61BT13), the operating ambient temperature must be reduced 5°C, against the maximum values described in general specifications. Lors du montage d'un module communication MELSECNET/II (GT15-J71LP23-25, GT15-J71BR13) ou du module de communication CC-Link (GT15-J61BT13), la température ambiante de fonctionnement doit être réduite de 5°C, par rapport aux valeurs maximales décrites dans les spécifications générales.
- Do not use or store the GOT under pressure higher than the atmospheric pressure of altitude 0m (0ft.). Failure to observe this instruction may cause a malfunction. When an air purge is made inside the control panel by adding pressure, there may be a clearance between the surface sheet and the screen making it difficult to use the touch panel, or the sheet may come off.
- This indicates the section of the power supply to which the equipment is assumed to be connected between the public electrical power distribution network and the machinery within the premises. Category II applies to equipment for which electrical power is supplied from fixed facilities.
- The surge voltage withstand level for up to the rated voltage of 300 V is 2500 V. This index indicates the degree to which conductive material is generated in the environment where the equipment is used. In pollution degree 2, only non-conductive pollution occurs but temporary conductivity may be produced due to condensation.

3.2 Power Supply Specifications

The following indicates the power supply specifications for GT25.

Item	Specifications		
	GT2512F-STNA	GT2510F-VTNA	GT2508F-VTNA
Power supply voltage	Power supply voltage AC100 to 240VAC (+10%, -15%)		
Power frequency	50/60Hz ± 5%		
Max. apparent power	80VA	80VA	70VA
Power consumption	maximum load Stand alone	35W or less 14W	34W or less 12W
Stand alone with backlight off	7W	7W	7W
Inrush current	60A or less (2ms, operating ambient temperature 25, maximum load)		
Allowable momentary power failure time	20 ms or less (100VAC or more)		
Noise immunity	1,500Vp-p noise voltage, 1μs noise width (when measuring with a noise simulator under 25 to 60Hz noise frequency)		
Dielectric withstand voltage	1500VAC for 1 minute across power terminals and earth		
Insulation resistance	10M or more across power terminals and earth by a 500V DC insulation resistance tester		
Applicable wire size	0.75(mm ²) to 2(mm ²)		
Applicable solderless terminal	Solderless terminal for M3 screw RAV1.25-3, V2-S3.3, V2-N3A, FV2-N3A		
Applicable tightening torque (Terminal block terminal screw)	0.5(N·m) to 0.8(N·m)		

3.2.1 For GOTs powered from the 100 to 240VAC power supply

Note
Operation at momentary failure
If an instantaneous power failure occurs in the power supply and continues for more than the permissible period, the GOT will be reset.
Make sure to power on the unit more than 5 seconds after power-off.

3.2.2 For GOTs powered from the 24VDC power supply

Item	Specifications		
	GT2512F-STND	GT2510F-VTND	GT2508F-VTND
Power supply voltage	DC24V		

4. EMC AND LOW VOLTAGE DIRECTIVE

For the products sold in European countries, the conformance to the EMC Directive, which is one of the European Directives, has been a legal obligation since 1996. Also, conformance to the Low Voltage Directive, another European Directive, has been a legal obligation since 1997.

Manufacturers who recognize their products must conform to the EMC and Low Voltage Directive are required to declare that their products conform to these Directives and put a "CE mark" on their products.

- Authorized representative in Europe
- Authorized representative in Europe is shown below.
- Name : Mitsubishi Electric Europe BV
- Address : Mitsubishi-Electric-Platz 1, 40882 Ratingen, Germany

4.1 Requirements to Meet EMC Directive

EMC Directives are those which require "any strong electromagnetic force is not output to the external: Emission (electromagnetic interference)" and "It is not influenced by the electromagnetic wave from the external: Immunity (electromagnetic sensitivity)". Items 4.1.1 through 4.1.3 summarize the precautions to use GOT and configure the mechanical unit in order to match the EMC directives. Though the data described herein are produced with our best on the basis of the requirement items and standards of the restrictions gathered by Mitsubishi Electric, they do not completely guarantee that all mechanical unit manufactured according to the data do not always match the above.

4.1.1 EMC directive

The standards of the EMC Directive are shown below.

Applied standard	Test standard	Test details	Standard value
EN61131-2:2007	CISPR16-2-3 Radiated noise ¹	Electromagnetic emissions from the product are measured.	30M-230MHz QP: 30dB μ V/m (30m in measurement range) ^{2, 3} 230M-1000MHz QP: 37dB μ V/m(30m in measurement range) ^{2, 3}
	CISPR16-2-1 Conducted noise ¹	Electromagnetic emissions from the product to the power line is measured.	150K-500kHz QP: 79dB, Mean: 66dB ² 500K-30MHz QP: 73dB, Mean: 60dB ²
	IEC61000-4-2 Electrostatic immunity ¹	Immunity test in which static electricity is applied to the cabinet of the equipment.	\pm 4kV Contact discharge \pm 8kV Aerial discharge
	IEC61000-4-3 Radiated electromagnetic field AM modulation	Immunity test in which field is irradiated to the product.	80-1000MHz: 10V/m 1.4-2GHz: 3V/m 2.0-2.7GHz: 1V/m 80%AM modulation@1kHz
	IEC61000-4-4 Fast transient burst noise ¹	Immunity test in which burst noise is applied to the power line and signal lines.	Power line: 2kV Digital I/O: 1kV Analog I/O: 1kV Signal lines: 1kV
EN61131-2:2007	IEC61000-4-5 Surge immunity ¹	Immunity test in which lightning surge is applied to the product.	AC power type Power line (between line and ground): \pm 2kV Power line (between lines): \pm 1kV Data communication port: \pm 1kV DC power type Power line (between line and ground): \pm 0.5kV Power line (between lines): \pm 0.5kV Data communication port: \pm 1kV
	IEC61000-4-6 Conducted RF immunity ¹	Immunity test in which a noise induced on the power and signal lines is applied.	Power line: 10V Data communication port: 10V
EN61131-2:2007	IEC61000-4-8 Power supply frequency magnetic field immunity	Test for checking normal operations under the circumstance exposed to the ferromagnetic field noise of the power supply frequency (50/60Hz).	30 A/m
	IEC61000-4-11 Instantaneous power failure and voltage dips immunity	Test for checking normal operations at instantaneous power failure.	AC power type 0.5 cycle 0% (interval 1 to 10s) 250/300 cycle 0% 10/12 cycle 40% 25/30 cycle 70%

- ¹: The GOT is an open type device (device installed to another device) and must be installed in a conductive control panel.
The above test items are conducted in the condition where the GOT is installed on the conductive control panel and combined with the Mitsubishi Electric PLC.
²: QP (Quasi-Peak): Quasi-peak value, Mean: Average value
³: The above test items are conducted in the following conditions.
30M-230MHz QP: 40dB μ V/m (10m in measurement range)
230M-1000MHz QP: 47dB μ V/m (10m in measurement range)

4.1.2 Control panel

The GOT is an open type device (device installed to another device) and must be installed in a conductive control panel. It not only assure the safety but also has a large effect to shut down the noise generated from GOT, on the control panel.

(1) Control Panel

- The control panel must be conductive.
- When fixing a top or bottom plate of the control panel with bolts, do not coat the plate and bolt surfaces so that they will come into contact.
And connect the door and box using a thick grounding cable in order to ensure the low impedance under high frequency.
- When using an inner plate to ensure electric conductivity with the control panel, do not coat the fixing bolt area of the inner plate and control panel to ensure conductivity in the largest area as possible.
- Ground the control panel using a thick grounding cable in order to ensure the low impedance under high frequency.
- The diameter of cable holes in the control panel must be 10cm (3.94in.). In order to reduce the chance of radio waves leaking out, ensure that the space between the control panel and its door is small as possible.

Paste the EMI gasket directly on the painted surface to seal the space so that the leak of electric wave can be suppressed. Our test has been carried out on a panel having the damping characteristics of 37dB max. and 30dB mean (measured by 3m method with 30 to 300MHz).

(2) Connection of power and ground wires

- Ground and power supply wires for the GOT must be connected as described below.
- Provide a grounding point near the GOT. Short-circuit the LG and FG terminals of the GOT (LG: line ground, FG: frame ground) and ground them with the thickest and shortest wire possible (The wire length must be 30cm (11.81in.) or shorter.)
The LG and FG terminals function is to pass the noise generated in the PC system to the ground, so an impedance that is as low as possible must be ensured. As the wires are used to relieve the noise, the wire itself carries a large noise content and thus short wiring means that the wire is prevented from acting as an antenna.
Note) A long conductor will become a more efficient antenna at high frequency.
 - The earth wire led from the earthing point must be twisted with the power supply wires.
By twisting with the earthing wire, noise flowing from the power supply wires can be relieved to the earthing. However, if a filter is installed on the power supply wires, the wires and the earthing wire may not need to be twisted.

4.1.3 Noise filter (power supply line filter)

The noise filter (power supply line filter) is a device effective to reduce conducted noise. Except some models, installation of a noise filter onto the power supply lines is not necessary. However conducted noise can be reduced if it is installed. (The noise filter is generally effective for reducing conducted noise in the band of 10MHz or less.) Usage of the following filters is recommended.

Model name	FN343-3/05	FN660-6/06	RSHN-2003
Manufacturer	SCHAFFNER	SCHAFFNER	TDK
Rated current	3A	6A	3A
Rated voltage	250V		

The precautions required when installing a noise filter are described below.

- Do not install the input and output cables of the noise filter together to prevent the output side noise will be induced into the input side cable where noise has been eliminated by the noise filter.

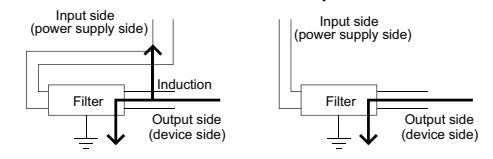

- Installing the input and output cables together will cause noise induction.
 - Separate the input cable from the output cable.
- Connect the noise filter's ground terminal to the control panel with the shortest cable as possible (approx. 10cm (3.94 in.) or less).

4.2 Requirements for Compliance with the Low Voltage Directive

The Low Voltage Directive requires each device which operates with power supply ranging from 50VAC to 1000V and 75VDC to 1500V to satisfy necessary safety items.

In the Sections from 4.2.1 to , cautions on installation and wiring of the GOT to conform to the Low Voltage Directive requires are described. We have put the maximum effort to develop this material based on the requirements and standards of the Directive that we have collected. However, compatibility of the devices which are fabricated according to the contents of this manual to the above Directive is not guaranteed. Each manufacturer who fabricates such device should make the final judgement about the application method of the Low Voltage Directive and the product compatibility.

4.2.1 Standard subject to GOT

Standard applied to GOT : EN61131-2 Programmable controllers - Equipment requirements and tests
EN60950-1 Safety of Information Technology Equipment

4.2.2 Power supply

The insulation specification of the GOT was designed assuming installation category II. Be sure to use the installation category II power supply to the GOT.
The installation category indicates the durability level against surge voltage generated by lightning strike.
Category I has the lowest durability; category IV has the highest durability.

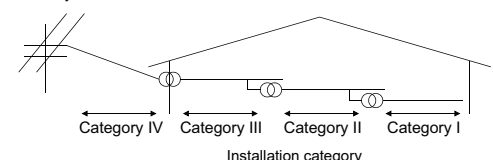

Installation category
Category II indicates a power supply whose voltage has been reduced by two or more levels of isolating transformers from the public power distribution.

4.2.3 Control panel

Because the GOT is open type equipment (device designed to be stored within another device), be sure to use it only when installed in a control panel.

- Shock Protection
In order to prevent those who are unfamiliar with power facility, e.g., an operator, from getting a shock, make sure to take the following measures on the control panel.
 - Store the GOT within the control panel locked, and allow only those who are familiar with power facility to unlock the panel.
 - Build the structure in order that the power supply will be shut off when the control panel is opened.
- Dustproof and waterproof features
The control panel also provides protection from dust, water and other substances. Insufficient ingress protection may lower the insulation withstand voltage, resulting in insulation destruction.
The insulation in the GOT is designed to cope with the pollution level 2, so use in an environment with pollution level 2 or better.

Pollution level 1: An environment where the air is dry and conductive dust does not exist.

Pollution level 2: An environment where conductive dust does not usually exist, but occasional temporary conductivity occurs due to the accumulated dust.
Generally, this is the level for inside the control panel equivalent a control room or on the floor of a typical factory.

Pollution level 3: An environment where conductive dust exists and conductivity may be generated due to the accumulated dust.
An environment for a typical factory floor.

Pollution level 4: Continuous conductivity may occur due to rain, snow, etc. An outdoor environment.

4.2.4 Grounding

The following are applicable ground terminals. Use them in the grounded state.
Be sure to ground the GOT for ensuring the safety and complying with the EMC Directive.
Functional grounding \downarrow : Improves the noise resistance.

5.3 Stud

5.3.1 Stud specifications

Use the studs that satisfy the following specifications

Diameter	Length
M4	10 mm (0.39 inch) or more

The studs on the control panel must have strength adequate to withstand a tightening torque of 0.9 N·m or more.
Make sure that no foreign matter such as welding waste is at and around the bases of the studs.
Tighten nuts on the studs in the specified torque range (0.8 N·m to 0.9 N·m) with a wrench for M4 nuts.

5.3.2 Distance between studs

To mount the GOT on the control panel, studs are necessary.
Align the studs with the installation holes of the fittings, and install the studs.
The fittings must be installed on the top and bottom, or the right and left of the GOT.
For GT2512F, you are recommended to install the fittings on the long sides of the GOT.

(1) Measurements based on the screen center

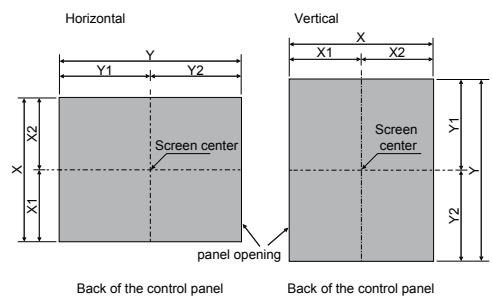

Model	X	X1	X2	Y	Y1	Y2
GT2512F-S	214(8.43) (+2.0,0.0)	103(4.06) (+2.0,0.0)	111(4.37)	289(10.99) (+2.0,0.0)	134(5.30) (+1.0,0.4)	134(5.30)
GT2510F-V	187(7.36) (+2.0,0.0)	86(3.35) (+1.0,0.4)	97(3.84)	234(9.21) (+2.0,0.0)	117(4.61) (+1.0,0.4)	117(4.61)
GT2508F-V	158(6.22) (+2.0,0.0)	75(2.96) (+1.0,0.4)	82(3.23)	194(7.64) (+2.0,0.0)	97(3.84) (+1.0,0.4)	96(3.80)

(2) Measurements for the horizontally-oriented GOT with fittings on its top and bottom

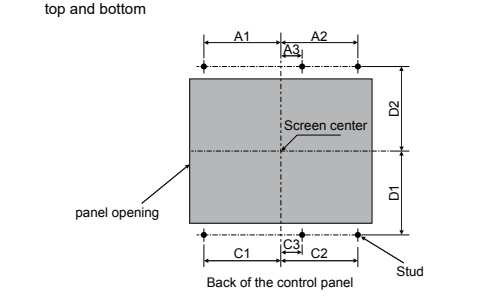

Model	A1	A2	A3	C1	C2	C3	D1	D2
GT2512F-S	98(3.86) (+1.5,0.0)	113(4.45) (+1.5,0.0)	7.5(0.30) (+1.5,0.0)	96(3.86) (+1.5,0.0)	113(4.45) (+1.5,0.0)	7.5(0.30) (+1.5,0.0)	128(5.06) (+1.5,0.0)	132(5.22) (+1.5,0.0)
GT2510F-V	105(4.15) (+1.5,0.0)	105(4.15) (+1.5,0.0)	0(0)	105(4.15) (+1.5,0.0)	105(4.15) (+1.5,0.0)	0(0)	114(4.51) (+1.5,0.0)	118(4.67) (+1.5,0.0)
GT2508F-V	64(2.54) (+1.5,0.0)	74(2.93) (+1.5,0.0)	-	64(2.54) (+1.5,0.0)	74(2.93) (+1.5,0.0)	-	104(4.11) (+1.5,0.0)	104(4.11) (+1.5,0.0)

(3) Measurements for the horizontally-oriented GOT with fittings on its right and left

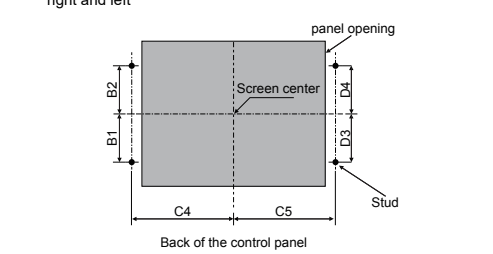

Model	B1	B2	C4	C5	D3	D4
GT2512F-S	75(2.97) (+1.5,0.0)	79(3.13) (+1.5,0.0)	160(6.30) (+1.5,0.0)	175(6.89) (+1.5,0.0)	75(2.97) (+1.5,0.0)	79(3.13) (+1.5,0.0)
GT2510F-V	58(2.28) (+1.5,0.0)	58(2.28) (+1.5,0.0)	161(6.34) (+1.5,0.0)	161(6.34) (+1.5,0.0)	58(2.28) (+1.5,0.0)	58(2.28) (+1.5,0.0)
GT2508F-V	58(2.28) (+1.5,0.0)	58(2.28) (+1.5,0.0)	126(4.96) (+1.5,0.0)	134(5.28) (+1.5,0.0)	58(2.28) (+1.5,0.0)	58(2.28) (+1.5,0.0)

(4) Measurements for the vertically-oriented GOT with fittings on its top and bottom

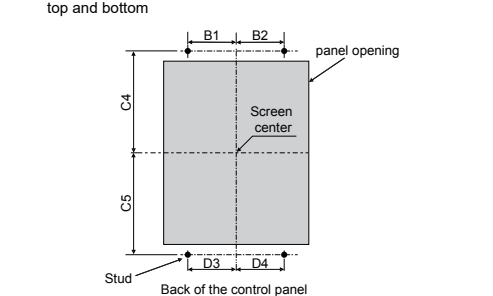

Model	B1	B2	C4	C5	D3	D4
GT2512F-S	75(2.97) (+1.5,0.0)	79(3.13) (+1.5,0.0)	160(6.30) (+1.5,0.0)	175(6.89) (+1.5,0.0)	75(2.97) (+1.5,0.0)	79(3.13) (+1.5,0.0)
GT2510F-V	58(2.28) (+1.5,0.0)	58(2.28) (+1.5,0.0)	161(6.34) (+1.5,0.0)	161(6.34) (+1.5,0.0)	58(2.28) (+1.5,0.0)	58(2.28) (+1.5,0.0)
GT2508F-V	58(2.28) (+1.5,0.0)	58(2.28) (+1.5,0.0)	126(4.96) (+1.5,0.0)	134(5.28) (+1.5,0.0)	58(2.28) (+1.5,0.0)	58(2.28) (+1.5,0.0)

(5) Measurements for the vertically-oriented GOT with fittings on its right and left

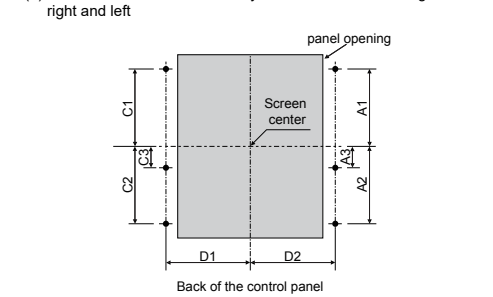

Model	A1	A2	A3	C1	C2	C3	D1	D2
GT2512F-S	98(3.86) (+1.5,0.0)	113(4.45) (+1.5,0.0)	7.5(0.30) (+1.5,0.0)	96(3.86) (+1.5,0.0)	113(4.45) (+1.5,0.0)	7.5(0.30) (+1.5,0.0)	128(5.06) (+1.5,0.0)	132(5.22) (+1.5,0.0)
GT2510F-V	105(4.15) (+1.5,0.0)	105(4.15) (+1.5,0.0)	0(0)	105(4.15) (+1.5,0.0)	105(4.15) (+1.5,0.0)	0(0)	114(4.51) (+1.5,0.0)	118(4.67) (+1.5,0.0)
GT2508F-V	64(2.54) (+1.5,0.0)	74(2.93) (+1.5,0.0)	-	64(2.54) (+1.5,0.0)	74(2.93) (+1.5,0.0)	-	104(4.11) (+1.5,0.0)	104(4.11) (+1.5,0.0)

5.4 Mounting Position

When mounting the GOT, the following clearances must be maintained from other structures and devices.
Some cables may need to be longer than the specified dimensions when connecting to the GOT.
Therefore, consider the connector dimensions and bending radius of the cable as well for installation.

For the lead-in allowance for cables at the bottom of the GOT, refer to the GOT2000 Series User's Manual (Hardware).
For the vertical installation, install the GOT so that the vertical installation arrow printed on the GOT rear face points upward.

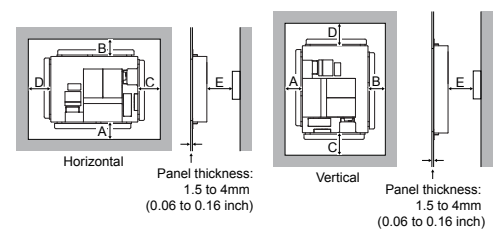

According to the dimensions in the following table, leave clearances between the GOT and the other devices. The values enclosed in square brackets apply to the case where no other equipment generating radiated noise (such as a contactor) or heat is installed near the GOT. However, keep the ambient temperature of the GOT to 55°C or lower.

Item	GT2512F-S	GT2510F-V	GT2508F-V
GOT only	58(2.28) or more [28(1.10) or more]	58(2.28) or more [28(1.10) or more]	58(2.28) or more [39(1.54) or more]
Ethernet communication unit is fitted	58(2.28) or more [28(1.10) or more]	58(2.28) or more [28(1.10) or more]	58(2.28) or more [39(1.54) or more]
Bus connection unit is fitted	58(2.28) or more [28(1.10) or more]	58(2.28) or more [28(1.10) or more]	58(2.28) or more [39(1.54) or more]
Serial communication unit is fitted	58(2.28) or more [28(1.10) or more]	58(2.28) or more [28(1.10) or more]	58(2.28) or more [39(1.54) or more]
CC-Link communication unit (GT15-J61BT13) fitted	58(2.28) or more [28(1.10) or more]	58(2.28) or more [28(1.10) or more]	58(2.28) or more [39(1.54) or more]
MELSECNET/H communication unit (coaxial) fitted ¹	58(2.28) or more [48(1.89) or more]	58(2.28) or more [55(2.17) or more]	77(3.03) or more
MELSECNET/H communication unit (optical) fitted ²	58(2.28) or more [28(1.10) or more]	58(2.28) or more [28(1.10) or more]	58(2.28) or more [28(1.10) or more]
CC-Link IE Controller Network communication unit fitted	58(2.28) or more [28(1.10) or more]	58(2.28) or more [28(1.10) or more]	58(2.28) or more [28(1.10) or more]
CC-Link IE Field Network communication unit fitted	58(2.28) or more [28(1.10) or more]	58(2.28) or more [28(1.10) or more]	58(2.28) or more [28(1.10) or more]
Printer unit fitted	58(2.28) or more [28(1.10) or more]	58(2.28) or more [28(1.10) or more]	58(2.28) or more [28(1.10) or more]
External I/O unit fitted	58(2.28) or more [28(1.10) or more]	58(2.28) or more [28(1.10) or more]	58(2.28) or more [28(1.10) or more]
Sound output unit fitted	58(2.28) or more [28(1.10) or more]	58(2.28) or more [28(1.10) or more]	58(2.28) or more [28(1.10) or more]
B	Horizontal: 88(3.46) or more [28(1.10) or more]	Vertical: 58(2.28) or more [28(1.10) or more]	Vertical: 58(2.28) or more [28(1.10) or more]
C	When the SD card is used	58(2.28) or more [28(1.10) or more]	58(2.28) or more [28(1.10) or more]
D	When the SD card is not used	58(2.28) or more [28(1.10) or more]	58(2.28) or more [28(1.10) or more]
E ³	100(3.94) or more[20(0.79) or more]		

- ¹: This value is for use of the coaxial cable 3C-2V (JIS C 3501).
For specifications of the cable, refer to the GOT2000 Series Connection Manual for a controller used.
²: This value differs depending on the cable used.
³: When opening or closing the battery cover: 72(2.83) or more

4.2.5 External wiring

- External devices
When a device with a hazardous voltage circuit is externally connected to the GOT, select a model which complies with the Low Voltage Directive's requirements for isolation between the primary and secondary circuits.
- Insulation requirements
Dielectric withstand voltages are shown in the following table.
Reinforced Insulation Withstand Voltage
(Installation Category II, source : IEC664)

Rated voltage of hazardous voltage area	Surge withstand voltage (1.2/50 μ s)
150 VAC or below	2500V
300 VAC or below	4000V

5. INSTALLATION

5.1 Control Panel Inside Dimensions for Mounting GOT

Install the GOT on the control panel out of the way for the equipment inside the control panel. Do not install the GOT and the unit in prohibited areas for the installation.

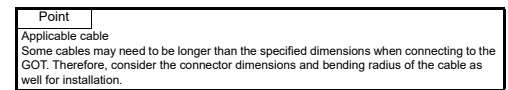

5.2 Panel Cutting Dimensions

Open an installation hole on the control panel with the dimensions as shown below.

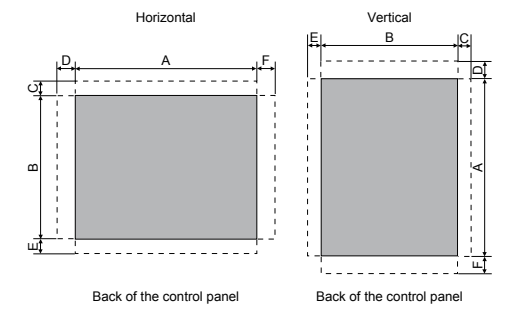

Model	Fitting installation position (on the GOT)	A	B	C	D	E
-------	--	---	---	---	---	---

5. INSTALLATION

5.1 Dimensions intérieures du tableau de commande pour le montage du GOT

Installez le GOT sur le tableau de commande en laissant de l'espace pour le dispositif à l'intérieur du tableau de commande. N'installez pas le GOT et le module dans des zones où l'installation est interdite.

Point
Câble applicable
Certains câbles peuvent être plus longs que les dimensions spécifiées lors de la connexion au GOT. Par conséquent, prenez également en compte les dimensions du connecteur et le rayon de courbure du câble pour l'installation.

5.2 Cotes de découpe du panneau

Ouvrez un orifice d'installation sur le tableau de commande avec les cotes indiquées ci-dessous.

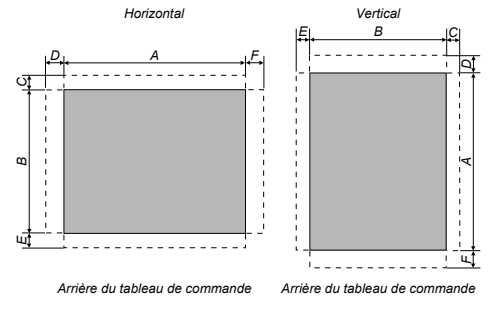

Modèle	Position d'installation du raccord (sur le GOT)	A	B	C	D	E	F	Épaisseur du panneau
GT2512F-S	Côté long du GOT	269(10.59)	214(8.43)	28(1.10)	17(0.67)	36(1.42)	26(1.02)	1,5(0,06) à 4(0,16)
	Côté court du GOT	10(0.39)	10(0.39)	35(1.38)	18(0.71)	44(1.73)		
GT2510F-V	Côté long du GOT	234(9.21)	187(7.36)	28(1.10)	33(1.30)	32(1.26)	33(1.30)	1,5(0,06) à 4(0,16)
	Côté court du GOT	10(0.39)	10(0.39)	51(2.01)	14(0.55)	51(2.01)		
GT2508F-V	Côté long du GOT	194(7.64)	138(5.22)	28(1.10)	14(0.55)	32(1.26)	29(1.14)	1,5(0,06) à 4(0,16)
	Côté court du GOT	10(0.39)	10(0.39)	32(1.26)	14(0.55)	47(1.85)		

Les cotes C à F indiquent les mesures d'installation des raccords sur le tableau de commande. De plus, installez les goujons sur le tableau de commande. Pour plus d'informations sur l'installation des goujons, voir ce qui suit.

5.3 Goujon

5.3.1 Spécifications des goujons

Utilisez les goujons qui répondent aux spécifications suivantes.

Diamètre	Longueur
M4	10 mm (0,39 pouce) ou plus

Les goujons sur le tableau de commande doivent avoir une résistance suffisante pour supporter un couple de serrage de 0,9 N·m ou plus. Assurez-vous qu'aucune matière étrangère, comme des déchets de soudure, ne se colle sur la base des goujons. Serrez les écrous sur les goujons dans la plage de couple de serrage spécifiée (entre 0,8 et 0,9 N·m) avec une clé pour écrous M4.

5.3.2 Distance entre les goujons

Pour monter le GOT sur le tableau de commande, des goujons sont nécessaires. Alignez les goujons avec les orifices d'installation des raccords, et installez les goujons.

Les raccords doivent être installés au-dessus et en dessous, ou à droite et à gauche du GOT. Pour GT2512F, il vous est conseillé d'installer les raccords sur les côtés longs du GOT.

(1) Mesures basées sur le centre de l'écran

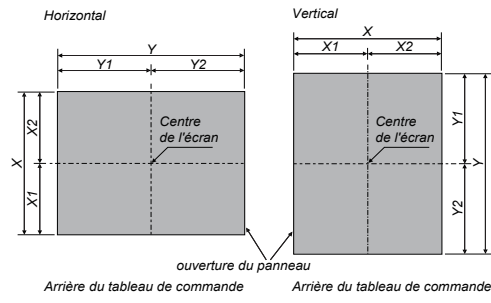

Modèle	X	X1	X2	Y	Y1	Y2
GT2512F-S	214(8.43)	187(7.36)	111(4.37)	269(10.59)	134(5.30)	134(5.30)
	10(0.39)	10(0.39)	10(0.39)	10(0.39)	10(0.39)	10(0.39)
GT2510F-V	187(7.36)	138(5.22)	97(3.84)	234(9.21)	117(4.61)	117(4.61)
	10(0.39)	10(0.39)	10(0.39)	10(0.39)	10(0.39)	10(0.39)
GT2508F-V	138(5.22)	97(3.84)	64(2.54)	194(7.64)	97(3.84)	96(3.80)
	10(0.39)	10(0.39)	10(0.39)	10(0.39)	10(0.39)	10(0.39)

(2) Mesures pour le GOT à l'horizontale avec les raccords au-dessus et en dessous

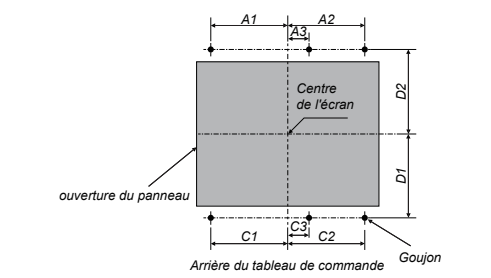

Modèle	A1	A2	A3	C1	C2	C3	D1	D2
GT2512F-S	98(3.86)	113(4.45)	7(0.30)	98(3.86)	113(4.45)	7(0.30)	128(5.06)	132(5.22)
	0.15(0.006)	0.15(0.006)	0.15(0.006)	0.15(0.006)	0.15(0.006)	0.15(0.006)	0.15(0.006)	0.15(0.006)
GT2510F-V	105(4.15)	105(4.15)	0(0)	105(4.15)	105(4.15)	0(0)	114(4.51)	118(4.67)
	0.15(0.006)	0.15(0.006)	0.15(0.006)	0.15(0.006)	0.15(0.006)	0.15(0.006)	0.15(0.006)	0.15(0.006)
GT2508F-V	64(2.54)	74(2.93)	-	64(2.54)	74(2.93)	-	104(4.11)	104(4.11)
	0.15(0.006)	0.15(0.006)	-	0.15(0.006)	0.15(0.006)	-	0.15(0.006)	0.15(0.006)

5.5 Température intérieure et angle d'installation du tableau de commande

Lors de l'installation du GOT sur un panneau, réglez la zone d'affichage comme indiqué ci-dessous. Si l'angle d'installation est différent de celui indiqué, le GOT se détériore plus tôt.

Installation du GOT à l'horizontale

Lors de l'installation du GOT avec un angle d'installation compris entre 60° et 105°, la température à l'intérieur du tableau de commande doit être d'environ 55°C. Lors de l'installation du GOT avec un angle d'installation non compris entre 60° et 105°, la température à l'intérieur du tableau de commande doit être d'environ 40°C.

Installation du GOT à la verticale

Lors de l'installation du GOT avec un angle de 90°, la température à l'intérieur du panneau de commande ne doit pas dépasser 55°C. Lors de l'installation du GOT avec tout autre angle que 90°, la température à l'intérieur du panneau de commande ne doit pas dépasser 40°C.

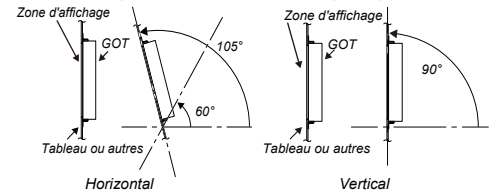

5.6 Installation du GOT

Pour serrer les raccords sur le tableau de commande, des goujons sont nécessaires.

- 1) Installez les raccords fournis sur le GOT avec des vis.
- 2) Alignez les orifices d'installation des raccords avec les goujons, et insérez les goujons dans les orifices.

Pour des détails sur les instructions d'installation du GOT, référez-vous au manuel GOT2000 Series User's Manual (Hardware).

6. MAINTENANCE AND INSPECTION

Refer to the GOT2000 Series User's Manual (Hardware) for maintenance and inspection for the GOT.

(3) Mesures pour le GOT à l'horizontale avec les raccords à droite et à gauche

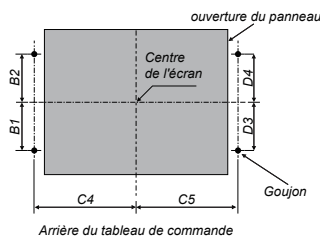

Modèle	B1	B2	C4	C5	D3	D4
GT2512F-S	75(2.97)	79(3.13)	160(6.30)	175(6.89)	75(2.97)	79(3.13)
	0.15(0.006)	0.15(0.006)	0.15(0.006)	0.15(0.006)	0.15(0.006)	0.15(0.006)
GT2510F-V	58(2.28)	58(2.28)	161(6.34)	161(6.34)	58(2.28)	58(2.28)
	0.15(0.006)	0.15(0.006)	0.15(0.006)	0.15(0.006)	0.15(0.006)	0.15(0.006)
GT2508F-V	58(2.28)	58(2.28)	126(4.96)	134(5.28)	58(2.28)	58(2.28)
	0.15(0.006)	0.15(0.006)	0.15(0.006)	0.15(0.006)	0.15(0.006)	0.15(0.006)

(4) Mesures pour le GOT à la verticale avec les raccords au-dessus et en dessous

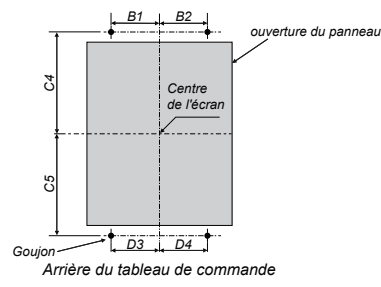

Modèle	B1	B2	C4	C5	D3	D4
GT2512F-S	75(2.97)	79(3.13)	160(6.30)	175(6.89)	75(2.97)	79(3.13)
	0.15(0.006)	0.15(0.006)	0.15(0.006)	0.15(0.006)	0.15(0.006)	0.15(0.006)
GT2510F-V	58(2.28)	58(2.28)	161(6.34)	161(6.34)	58(2.28)	58(2.28)
	0.15(0.006)	0.15(0.006)	0.15(0.006)	0.15(0.006)	0.15(0.006)	0.15(0.006)
GT2508F-V	58(2.28)	58(2.28)	126(4.96)	134(5.28)	58(2.28)	58(2.28)
	0.15(0.006)	0.15(0.006)	0.15(0.006)	0.15(0.006)	0.15(0.006)	0.15(0.006)

(5) Mesures pour le GOT à la verticale avec les raccords à droite et à gauche

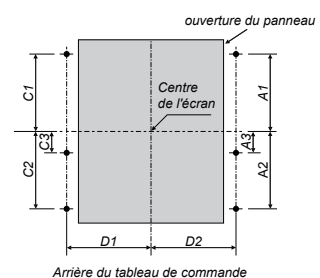

Modèle	A1	A2	A3	C1	C2	C3	D1	D2
GT2512F-S	98(3.86)	113(4.45)	7(0.30)	98(3.86)	113(4.45)	7(0.30)	128(5.06)	132(5.22)
	0.15(0.006)	0.15(0.006)	0.15(0.006)	0.15(0.006)	0.15(0.006)	0.15(0.006)	0.15(0.006)	0.15(0.006)
GT2510F-V	105(4.15)	105(4.15)	0(0)	105(4.15)	105(4.15)	0(0)	114(4.51)	118(4.67)
	0.15(0.006)	0.15(0.006)	0.15(0.006)	0.15(0.006)	0.15(0.006)	0.15(0.006)	0.15(0.006)	0.15(0.006)
GT2508F-V	64(2.54)	74(2.93)	-	64(2.54)	74(2.93)	-	104(4.11)	104(4.11)
	0.15(0.006)	0.15(0.006)	-	0.15(0.006)	0.15(0.006)	-	0.15(0.006)	0.15(0.006)

5.4 Position de montage

Lors du montage du GOT, laissez les espaces suivants pour les autres structures et dispositifs. Certains câbles peuvent être plus longs que les dimensions spécifiées lors de la connexion au GOT. Par conséquent, prenez également en compte les dimensions du connecteur et le rayon de courbure du câble pour l'installation. Pour connaître l'espace à laisser pour les câbles sous le GOT, référez-vous au manuel GOT2000 Series User's Manual (Hardware). Pour l'installation à la verticale, installez le GOT de sorte que la flèche d'installation à la verticale imprimée sur la face arrière du GOT pointe vers le haut.

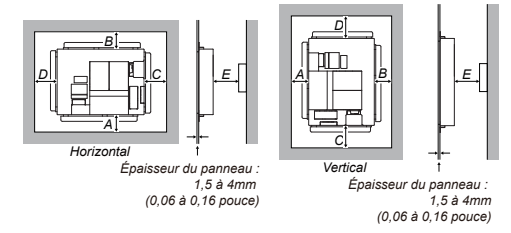

Laissez les espaces entre le GOT et les autres dispositifs en fonction des dimensions contenues dans le tableau suivant. Les valeurs entre parenthèses s'appliquent au cas où aucun dispositif générant des émissions sonores (comme un contacteur) ou de la chaleur n'est installé près du GOT. Toutefois, maintenez la température ambiante du GOT à 55°C ou moins.

Article	GT2512F-S	GT2510F-V	GT2508F-V
GOT uniquement	58(2,28) ou plus (28(1,10) ou plus)	58(2,28) ou plus (39(1,54) ou plus)	58(2,28) ou plus (39(1,54) ou plus)
Unité de communication Ethernet encastree	58(2,28) ou plus(28(1,10) ou plus)		
Unité de connexion de bus encastree	58(2,28) ou plus (28(1,10) ou plus)	33(1,30) ou plus (39(1,54) ou plus)	
Unité de connexion série encastree	58(2,28) ou plus(28(1,10) ou plus)		
Module de communication CC-Link (GT15-J61BT13) encastree	58(2,28) ou plus(28(1,10) ou plus)		
A Module de communication MELSECNET/H (coaxial) encastree*1	58(2,28) ou plus (48(1,89) ou plus)	58(2,28) ou plus (55(2,17) ou plus)	77(3,03) ou plus
	Module de communication MELSECNET/H (optique) encastree*2		
Module de communication réseau de contrôleur CC-Link IE encastree	58(2,28) ou plus(28(1,10) ou plus)		
Module de communication réseau de champ CC-Link IE encastree	58(2,28) ou plus(28(1,10) ou plus)		
Imprimante encastree	58(2,28) ou plus(28(1,10) ou plus)		
Module d'E/S externe encastree	58(2,28) ou plus(28(1,10) ou plus)		
Module de sortie acoustique encastree	58(2,28) ou plus(28(1,10) ou plus)		
B	Horizontal: 88(3,46) ou plus (28(1,10) ou plus) Vertical: 58(2,28) ou plus (28(1,10) ou plus)		
	C	Quand la carte SD est utilisée	58(2,28) ou plus (28(1,10) ou plus)
Quand la carte SD n'est pas utilisée		58(2,28) ou plus(28(1,10) ou plus)	
D	Horizontal: 58(2,28) ou plus (28(1,10) ou plus) Vertical: 88(3,46) ou plus (28(1,10) ou plus)		
	E ³	100(3,94) ou plus(20(0,79) ou plus)	

*1: Cette valeur est utilisée pour le câble coaxial 3C-2V (JIS C 3501). Pour connaître les spécifications du câble, référez-vous au manuel GOT2000 Series Connection Manual pour un contrôleur utilisé.
*2: Cette valeur diffère selon le câble utilisé.
*3: Pour ouvrir ou fermer le couvercle de la batterie : 72(2,83) ou plus

Warranty

Mitsubishi Electric will not be held liable for damage caused by factors found not to be the cause of Mitsubishi Electric; machine damage or lost profits caused by faults in the Mitsubishi Electric products; damage, secondary damage, accident compensation caused by special factors unpredictable by Mitsubishi Electric; damages to products other than Mitsubishi Electric products; and to other duties.

For safe use

- This product has been manufactured as a general-purpose part for general industries, and has not been designed or manufactured to be incorporated in a device or system used in purposes related to human life.
- Before using the product for special purposes such as nuclear power, electric power, aerospace, medicine or passenger movement vehicles, consult with Mitsubishi Electric.
- This product has been manufactured under strict quality control. However, when installing the product where major accidents or losses could occur if the product fails, install appropriate backup or failsafe functions in the system.

Country/Region	Sales office/Tel
USA	Mitsubishi Electric Automation, Inc. 500 Corporate Woods Parkway, Vernon Hills, IL 60061, U.S.A. Tel: +1-847-478-2100
Brazil	Mitsubishi Electric do Brasil Comercio e Servicos Ltda. Avenida Adesino Cardana, 293, 21 andar, Bethaville, Barueri SP, Brazil Tel: +55-11-4689-3000
Mexico	Mitsubishi Electric Automation, Inc. Mexico Branch Boulevard Miguel de Cervantes Saavedra 301, Torre Norte Piso 5, Ampliacion Granada, Miguel Hidalgo, Ciudad de Mexico, Mexico, C.P. 11520 Tel: +52-55-3067-7512
Germany	Mitsubishi Electric Europe B.V. German Branch Mitsubishi-Electric-Platz 1, 40882 Ratingen, Germany Tel: +49-2102-480-0
UK	Mitsubishi Electric Europe B.V. UK Branch Travelers Lane, UK-Halford, Hertfordshire, AL10 8XB, U.K. Tel: +44-1707-28-8780
Italy	Mitsubishi Electric Europe B.V. Italian Branch Centro Direzionale Colleoni - Palazzo Sirio, Viale Colleoni 7, 20064 Agrate Brianza (MB), Italy Tel: +39-039-60531
Spain	Mitsubishi Electric Europe B.V. Spanish Branch Carretera de Rubi, 75-80-Adpo. 420, E-08190 Sant Cugat del Valles (Barcelona), Spain Tel: +34-935-65-3131
France	Mitsubishi Electric Europe B.V. French Branch 25, Boulevard des Bouvels, 92741 Nanterre Cedex, France Tel: +33-1-55-68-55-88
Czech	Mitsubishi Electric Europe B.V. Czech Branch Pekarský pr. 2, bld 2, "Sch", BC "Benua", office 720, 195027 St. Petersburg, Russia Tel: +420-255 719 200
Turkey	Mitsubishi Electric Turkey A.S. Umraniye Branch Serifali Mahallesi Nispetiye Sokak No.5, TR-34775 Umraniye / Istanbul, Turkey Tel: +90-216-526-3990
Poland	Mitsubishi Electric Europe B.V. Polish Branch ul. Krakowska 48, 32-083 Balice, Poland Tel: +48-12-347-65-00
Russia	Mitsubishi Electric (Russia) LLC St. Petersburg Branch Pekarsky pr. 2, bld 2, "Sch", BC "Benua", office 720, 195027 St. Petersburg, Russia Tel: +7-812-633-3497
South Africa	Adroit Technologies 20 Waterford Office Park, 189 Witkoppen Road, Fourways, South Africa Tel: +27-11-658-8100
China	Mitsubishi Electric Automation (China) Ltd. Mitsubishi Electric Automation Center, No.1386 Honggao Road, Shanghai, China Tel: +86-21-2322-3030
Taiwan	SETSUYO ENTERPRISE CO., LTD. 6F, No. 105, Wugong 3rd Road, Wugu District, New Taipei City 24889, Taiwan Tel: +886-2-2299-2499
Korea	Mitsubishi Electric Automation Korea Co., Ltd. 7F to 9F, Gangseo Hangang Xi-tower A, 401, Yangcheon-ro, Gangseo-Gu, Seoul 07528, Korea Tel: +82-2-3660-9569
Singapore	Mitsubishi Electric Asia Pte. Ltd. 307 Alexandra Road, Mitsubishi Electric Building, Singapore 159943 Tel: +65-6473-2308
Thailand	Mitsubishi Electric Factory Automation (Thailand) Co., Ltd. 12th Floor, SV City Building, Office Tower 1, No. 898/19 and 20 Rama 3 Road, Kwaeng Bangpongngang, Khet Yama, Bangkok 10120, Thailand Tel: +66-2682-6522 to 31
Indonesia	PT. Mitsubishi Electric Indonesia Gedung Jaya 8th Floor, JL. MH. Thamrin No.12, Jakarta Pusat 10340, Indonesia Tel: +62-21-3192-6461
Vietnam	Mitsubishi Electric Vietnam Company Limited 11th & 12th Floor, Viettel Tower B, 285 Cach Mang Thang 8 Street, Ward 12, District 10, Ho Chi Minh City, Vietnam. Tel: +84-28-3910-5945
India	Mitsubishi Electric India Pvt. Ltd. Pune Branch Emerald House, EL-3, J Block, M.I.D.C., Bhosari, Pune - 411026, Maharashtra, India Tel: +91-20-2710-2000
Australia	MITSUBISHI ELECTRIC AUSTRALIA PTY. LTD. 348 Victoria Road, P.O. Box 11, Rydalmere, N.S.W. 2116, Australia Tel: +61-2-9684-7777

MITSUBISHI ELECTRIC CORPORATION

HEAD OFFICE: TOKYO BUILDING, 2-7-3 MARUNOUCHI, CHYODA-KU, TOKYO 100-8310, JAPAN
NAGOYA WORKS: 1-14, YADA-MINAMI 5-CHOME, HIGASHI-KU, NAGOYA, JAPAN

When exported from Japan, this manual does not require application to the Ministry of Economy, Trade and Industry for service transaction permission.
Specifications subject to change without notice.
Printed in Japan, August 2020.