



GOT2000/GOT1000 Series CC-Link Communication Unit

User's Manual GT15-J61BT13

Thank you for choosing Mitsubishi Electric Graphic Operation Terminal (GOT).

Prior to use, please read both this manual and detailed manual thoroughly to fully understand the product.

MODEL	GT15-J61BT13-U
MODEL CODE	1D7M57
IB(NA)-0800351-L(2011)MEE	

●SAFETY PRECAUTIONS●

(Always read these instructions before using this equipment.)

Before using this product, please read this manual and the relevant manuals introduced in this manual carefully and pay full attention to safety to handle the product correctly.

The instructions given in this manual are concerned with this product. In this manual, the safety instructions are ranked as "WARNING" and "CAUTION".



Indicates that incorrect handling may cause hazardous conditions, resulting in death or severe injury.



Indicates that incorrect handling may cause hazardous conditions, resulting in medium or slight personal injury or physical damage.

Note that the  CAUTION level may lead to a serious accident according to the circumstances.

Always follow the precautions of both levels because they are important to personal safety.

Please save this manual to make it accessible when required and always forward it to the end user.

[DESIGN PRECAUTIONS]

WARNING

- Some faults of this unit may keep the outputs on or off. An external monitoring circuit should therefore be provided to check for output signals which may lead to a serious accident.
Not doing so can cause an accident due to mis-output or misoperation.
- If a communication error (including cable disconnection) occurs during monitoring with the GOT, communication between the GOT and master station is interrupted, disabling operation.
When using the GOT to configure a system, assume that a GOT communication error will occur and configure a system in which switches used to perform significant operation for the system are provided on any device other than the GOT.
Not doing so can cause an accident due to mis-output or misoperation.

[DESIGN PRECAUTIONS]

WARNING

- To maintain the security (confidentiality, integrity, and availability) of the GOT and the system against unauthorized access, DoS*¹ attacks, computer viruses, and other cyberattacks from unreliable networks and devices via network, take appropriate measures such as firewalls, virtual private networks (VPNs), and antivirus solutions.

Mitsubishi Electric shall have no responsibility or liability for any problems involving GOT trouble and system trouble by unauthorized access, DoS attacks, computer viruses, and other cyberattacks.

*1 DoS: A denial-of-service (DoS) attack disrupts services by overloading systems or exploiting vulnerabilities, resulting in a denial-of-service (DoS) state.

CAUTION

- Do not bunch the control wires or communication cables with the main circuit or power wires, or lay them close to each other.
As a guide, separate the lines by a distance of at least 100mm (3.94 inches) otherwise malfunctions may occur due to noise.

[INSTALLATION PRECAUTIONS]

WARNING

- Be sure to shut off all phases of the external power supply used by the system before mounting or removing this unit to/from the GOT.
Not doing so can cause a unit failure or misoperation.

CAUTION

- Use this unit in the environment that satisfies the general specifications described in the User's Manual for the GOT used.
Not doing so can cause an electric shock, fire, malfunction or product damage or deterioration.

[INSTALLATION PRECAUTIONS]

CAUTION

- When installing this unit to the GOT, fit it to the connection interface of the GOT and tighten the mounting screws in the specified torque range (0.36 N•m to 0.48 N•m) with a Phillips-head screwdriver No.2.
Undertightening can cause a drop, failure or malfunction.
Overtightening can cause a drop, failure or malfunction due to screw or unit damage.

[WIRING PRECAUTIONS]

WARNING

- Be sure to shut off all phases of the external power supply used by the system before wiring.
Not doing so can cause an electric shock, product damage or misoperation.

CAUTION

- Connect the connectors to the unit securely.
- Always ground the FG terminal of the GOT power supply and the FG terminal of this unit to the protective ground conductor.
Be sure to ground the GOT and this unit separately.
Not doing so may cause an electric shock or misoperation.
- Before wiring the unit, confirm the rated voltage and terminal arrangement of the product.
A fire or failure can occur if the power supply connected is different from the rating or wiring is incorrect.
- Use applicable solderless terminals and tighten them with the specified torque. If any solderless spade terminal is used, it may be disconnected when the terminal screw comes loose, resulting in failure.
- Tighten the terminal screws within the specified torque range.
Undertightening can cause a short circuit or misoperation.
Overtightening can cause a short circuit or misoperation due to damaged screws or unit.
- Ensure that foreign matters such as chips and wire off-cuts do not enter the unit.
They can cause a fire, failure or misoperation.

[WIRING PRECAUTIONS]

CAUTION

- Be sure to fix the wires or cables by ducts or clamps when connecting them to the unit.
Not doing so can damage the unit or cables due to dangling, moved or accidentally pulled cables or can cause misoperation due to cable contact fault.
- Do not install the control lines together with the communication cables, or bring them close to each other.
Failure to do so may cause malfunctions due to noise.
- When disconnecting a communication or power supply cable from the unit, do not pull on the cable itself.
Disconnect cables fitted with connectors by holding and pulling the cable connector. Disconnect cables not fitted with a connector by removing the screws from the part connected to the unit.
Pulling on a cable that is connected to the unit can cause damage to the unit or cable, or malfunction due to cable connection faults.

[TEST OPERATION PRECAUTIONS]

WARNING

- Do not output (switch on) any reserved signal among the output signals provided from the master unit to the GOT.
Doing so can cause the PLC system to misoperate.

[STARTUP AND MAINTENANCE PRECAUTIONS]

WARNING

- Do not touch the terminals while power is on.
Doing so can cause an electric shock or misoperation.
- Before starting cleaning or terminal screw retightening, always switch power off externally in all phases.
Not doing so can cause a unit failure or misoperation.
Undertightening can cause a drop, short circuit or misoperation.
Overtightening can cause a drop, short circuit or misoperation due to damaged screws or unit.

[STARTUP AND MAINTENANCE PRECAUTIONS]

CAUTION

- Do not disassemble or modify the unit.
Doing so can cause a failure, misoperation, injury or fire.
- Do not touch the conductive areas and electronic parts of the unit.
Doing so can cause the unit to misoperate or fail.
- Do not drop the unit or subject it to strong impact.
Doing so can damage the unit.
- Always make sure to touch the grounded metal to discharge the electricity charged in the body, etc., before touching the unit.
Failure to do so may cause a failure or malfunctions of the unit.

[DISPOSAL PRECAUTIONS]

CAUTION

- Dispose of this product as industrial waste.

[TRANSPORTATION PRECAUTIONS]

CAUTION

- Make sure to transport the GOT main unit and/or relevant unit(s) in the manner they will not be exposed to the impact exceeding the impact resistance described in the general specifications of Use this unit in the environment that satisfies the general specifications described in the User's Manual for the GOT used., as they are precision devices.
Failure to do so may cause the unit to fail.
Check if the unit operates correctly after transportation.
- When fumigants that contain halogen materials such as fluorine, chlorine, bromine, and iodine are used for disinfecting and protecting wooden packaging from insects, they cause malfunction when entering our products. Please take necessary precautions to ensure that remaining materials from fumigant do not enter our products, or treat packaging with methods other than fumigation (heat method). Additionally, disinfect and protect wood from insects before packing products.

REVISIONS

* The manual number is noted at the lower right of the top cover.

Print Date	*Manual Number	Revision
Mar., 2006	IB(NA)-0800351-A	First edition
Sep., 2006	IB(NA)-0800351-B	Partial addition Chapter 1 Addition Compliance with the EMC and Low Voltage Directives
Jul., 2007	IB(NA)-0800351-C	Partial corrections Compliance with the EMC and Low Voltage Directive, Chapter 2, 4, 5
Jan., 2009	IB(NA)-0800351-D	Partial addition Chapter 1, 2, 4, 5
Jun., 2009	IB(NA)-0800351-E	Partial corrections Compliance with the EMC and Low Voltage Directives
Jun., 2011	IB(NA)-0800351-F	Partial corrections Chapter 4 Partial addition Compliance with the Radio Waves Act (South Korea)
Oct., 2014	IB(NA)-0800351-G	Partial corrections SAFETY PRECAUTIONS Chapter 4, 5
May, 2015	IB(NA)-0800351-H	Partial corrections Cover
Oct., 2016	IB(NA)-0800351-I	Partial corrections Compliance with the RoHS
Apr., 2017	IB(NA)-0800351-J	Partial corrections Cover

Print Date	*Manual Number	Revision
Jun., 2018	IB(NA)-0800351-K	Partial addition Compliance with Chinese standardized law
Nov., 2020	IB(NA)-0800351-L	Partial corrections SAFETY PRECAUTIONS

This manual confers no industrial property rights or any rights of any other kind, nor does it confer any patent licenses. Mitsubishi Electric Corporation cannot be held responsible for any problems involving industrial property rights which may occur as a result of using the contents noted in this manual.

CONTENTS

1. OVERVIEW	1
2. SPECIFICATIONS	2
2.1 Performance Specifications	2
2.2 Specifications of terminal block socket	4
3. I/O SIGNALS AND REMOTE REGISTER ASSIGNMENT	5
3.1 I/O Signals Transferred to/from the Master Module	5
3.2 Remote Register Assignment	7
4. PART NAMES AND EXTERNAL DIMENSIONS	8
5. INSTALLATION PROCEDURE	11
5.1 CC-Link communication unit installation	11
5.2 Terminal block socket installation	13
6. WIRING METHOD	14

Manual

The following shows manuals relevant to this product.

Detailed Manuals

Manual name	Manual number (Model code)
GOT2000 Series User's Manual (Hardware) (Sold separately)	SH-081194ENG (1D7MJ5)
GOT2000 Series Connection Manual (Mitsubishi Products) For GT Works3 Version1 (Sold separately)	SH-081197ENG (1D7MJ8)
GT16 User's Manual (Hardware) (Sold separately)	SH-080928ENG (1D7MD3)
GT15 User's Manual (Sold separately)	SH-080528ENG (1D7M23)
GOT1000 Series Connection Manual (Mitsubishi Products) for GT Works3 (Sold separately)	SH-080868ENG (1D7MC2)

Relevant Manuals

For relevant manuals, refer to the PDF manuals stored in the DVD-ROM for the drawing software used.

Compliance with the EMC and Low Voltage Directives

To configure a system meeting the requirements of the EMC and Low Voltage Directives when incorporating the Mitsubishi GOT (EMC and Low Voltage Directives compliant) into other machinery or equipment, refer to "EMC AND LOW VOLTAGE DIRECTIVES" of the General Description included with the GOT used.

The CE mark, indicating compliance with the EMC and Low Voltage Directives, is printed on the rating plate of the GOT.

Compliance with the new China RoHS directive

GOT 相关的基于 “ 电器电子产品有害物质限制使用管理办法 ” 要求的表示方法



Note: This symbol mark is for China only.

含有有害 6 物质的名称、含有量、含有部件

本产品中所含有的有害 6 物质的名称、含有量、含有部件如下表所示。

产品中有害物质的名称及含量

部件名称	有害物质					
	铅 (Pb)	汞 (Hg)	镉 (Cd)	六价铬 (Cr(VI))	多溴联苯 (PBB)	多溴二苯醚 (PBDE)
电路板组件	×	○	○	○	○	○
树脂壳体、电缆、膜材	○	○	○	○	○	○
钣金部件、螺丝等金属部件	○	○	○	○	○	○

本表格依据 SJ/T11364 的规定编制。

○：表示该有害物质在该部件所有均质材料中的含量均在 GB/T26572 规定的限量要求以下。

×：表示该有害物质至少在该部件的某一均质材料中的含量超出 GB/T26572 规定的限量要求。

Referenced Standard: GB/T15969.2 (Requirement of Chinese standardized law)

Packing List

The following items are included.

Model	Product	Quantity
GT15-J61BT13	CC-Link communication unit	1
	Mounting screw set (2 screws, 2 stickers)	2
	Extension interface relay board	1
	Terminating resistor 110Ω 1/2W (brown, brown, brown)* ¹	1
	Plate type solderless terminal set	
	Terminating resistor 130Ω 1/2W (brown, orange, brown)* ²	1
	Plate type solderless terminal set	
	Solderless terminal (For connecting the braid shield wire, Plate type)	2
	Terminal block socket	1
	GOT2000/GOT1000 Series CC-Link Communication Unit User's Manual (This manual)	1

*1 Use it when using the Ver.1.10 compatible CC-Link dedicated cable/ Ver.1.00 compatible CC-Link dedicated cable.

*2 Use it when using the Ver.1.00 compatible CC-Link dedicated high-performance cable.

1. OVERVIEW

This user's manual describes the GOT2000/GOT1000 series CC-Link communication unit (hereinafter referred to as the CC-Link communication unit) to be used in the Control & Communication Link (CC-Link) system. For attachable GOTs, refer to the User's Manual for the GOT used.

The CC-Link communication unit can be connected to the GOT, which can perform monitoring as an intelligent device station (number of occupied stations selectable from 1 station / 4 stations) in the CC-Link system.

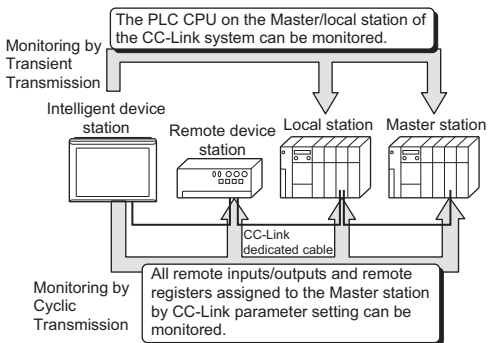

When using the CC-Link connection, make the communication setting to perform communication with PLCs.

For the details of the CC-Link connection, refer to the GOT2000 or GOT1000 Series Connection Manual (Mitsubishi Products).

2. SPECIFICATIONS

2.1 Performance Specifications

The following is the performance specification of CC-Link communication unit. The general specification of the CC-Link communication unit are the same as those of the GOT.

For the general specifications of the GOT refer to the User's Manual for the GOT used. *1

Item		Specifications	
CC-Link station type		Intelligent device station	
Number of occupied stations		May be selected between 1 and 4.	
Maximum number of link points per system	Ver.2 mode	Remote I/O(RX, RY)*2	8192 points
		Remote register(RWw)	2048 points
		Remote register(RWr)	2048 points
	Ver.1 mode	Remote I/O(RX, RY)*2	2048 points
		Remote register(RWw)	256 points
		Remote register(RWr)	256 points
Number of link points per station		Refer to *3	
Number of link points per number of occupied stations		Refer to *4	
Transmission speed		156kbps/625kbps/2.5Mbps/5Mbps/10Mbps	
Max. transmission distance		Depends on the transmission speed.	
Max. number of modules connected		26 The max. number of modules connected depends on the configuration of the CC-Link system to be used. For more details on the max. number of modules connected, refer to the CC-Link System Master-Local Module User's Manual.	
Connection cable		CC-Link dedicated cable	
Internal current consumption (5VDC)		0.56A	
Weight		0.18kg (0.40lb)	

- *1 When installing an extension unit on the CC-Link communication unit, limit the maximum operating ambient temperature by subtracting 5 degrees from operating ambient temperature of the general specifications.
- *2 Each of the I/O signals (RX, RY) occupies 16 points of a system area within device points.
For more details on the I/O signals, refer to Section 3.1.

*3 The number of link points per station depends on the mode setting of CC-Link as shown below.

For CC-Link Ver.2

Link device	Number of link points per station			
	Extension cyclic setting			
	Single	Double	Quadruple	Octuple
Remote I/O(RX, RY)	32 points	32 points	64 points	128 points
Remote register(RWw)	4 points	8 points	16 points	32 points
Remote register(RWr)	4 points	8 points	16 points	32 points

For CC-Link Ver.1

Link device	Number of link points per station
Remote I/O(RX, RY)	32 points
Remote register(RWw)	4 points
Remote register(RWr)	4 points

*4 The number of link points per number of occupied stations depends on the mode setting of CC-Link as shown below.

For CC-Link Ver.2

Link device	Number of link points per station							
	Extension cyclic setting							
	Single		Double		Quadruple		Octuple	
	1 station occupied	4 station occupied	1 station occupied	4 station occupied	1 station occupied	4 station occupied	1 station occupied	4 station occupied
Remote I/O(RX, RY)	32 points	128 points	32 points	224 points	64 points	448 points	128 points	896 points
Remote register(RWw)	4 points	16 points	8 points	32 points	16 points	64 points	32 points	128 points
Remote register(RWr)	4 points	16 points	8 points	32 points	16 points	64 points	32 points	128 points

For CC-Link Ver.1

Link device	Number of link points per station	
	1 station occupied	4 station occupied
Remote I/O(RX, RY)	32 points	128 points
Remote register(RWw)	4 points	16 points
Remote register(RWr)	4 points	16 points

2.2 Specifications of terminal block socket

Item	Specifications
Screw tightening torque	Wiring screw : 0.5 to 0.6 N•m Terminal block fixing screw : 0.7 to 0.8 N•m
Recommended driver	Flat-blade screwdriver (Blade thickness 0.6mm, Width 3.5mm)

3. I/O SIGNALS AND REMOTE REGISTER ASSIGNMENT

3.1 I/O Signals Transferred to/from the Master Module

The following table lists the I/O signals assigned to the GOT.

The I/O signals differ according to the set number of occupied stations (1 or 4 stations).

n in the table indicates the address assigned to the Master module by station number setting.

Signal Direction : GOT → Master module				
Device No.				Signal name
Extension cyclic setting* ¹				
Single		Double		
1 station occupied	4 station occupied	1 station occupied	4 station occupied	
RXn0 to RXnF	RXn0 to RX(n+6)F	RXn0 to RXnF	RXn0 to RX(n+C)F	User area
RX(n+1)0 to RX(n+1)A	RX(n+7)0 to RX(n+7)A	RX(n+1)0 to RX(n+1)A	RX(n+D)0 to RX(n+D)A	Reserved
RX(n+1)B	RX(n+7)B	RX(n+1)B	RX(n+D)B	Remote READY flag ²
RX(n+1)C to RX(n+1)F	RX(n+7)C to RX(n+7)F	RX(n+1)C to RX(n+1)F	RX(n+D)C to RX(n+D)F	Reserved

Signal Direction : GOT → Master module				
Device No.				Signal name
Extension cyclic setting* ¹				
Quadruple		Octuple		
1 station occupied	4 station occupied	1 station occupied	4 station occupied	
RXn0 to RX(n+2)F	RXn0 to RX(n+1A)F	RXn0 to RX(n+6)F	RXn0 to RX(n+36)F	User area
RX(n+3)0 to RX(n+3)A	RX(n+1B)0 to RX(n+1B)A	RX(n+7)0 to RX(n+7)A	RX(n+37)0 to RX(n+37)A	Reserved
RX(n+3)B	RX(n+1B)B	RX(n+7)B	RX(n+37)B	Remote READY flag ²
RX(n+3)C to RX(n+3)F	RX(n+1B)C to RX(n+1B)F	RX(n+7)C to RX(n+7)F	RX(n+37)C to RX(n+37)F	Reserved

Signal Direction : GOT→Master module				
Device No.				Signal name
Extension cyclic setting ^{*1}				
Single		Double		
1 station occupied	4 station occupied	1 station occupied	4 station occupied	
RYn0 to RYnF	RYn0 to RY(n+6)F	RYn0 to RYnF	RYn0 to RY(n+C)F	User area
RY(n+1)0 to RY(n+1)F	RY(n+7)0 to RY(n+7)F	RY(n+1)0 to RY(n+1)F	RY(n+D)0 to RY(n+D)F	Reserved

Signal Direction : GOT→Master module				
Device No.				Signal name
Extension cyclic setting ^{*1}				
Quadruple		Octuple		
1 station occupied	4 station occupied	1 station occupied	4 station occupied	
RYn0 to RY(n+2)F	RYn0 to RY(n+1A)F	RYn0 to RY(n+6)F	RYn0 to RY(n+36)F	User area
RY(n+3)0 to RY(n+3)F	RY(n+1B)0 to RY(n+1B)F	RY(n+7)0 to RY(n+7)F	RY(n+37)0 to RY(n+37)F	Reserved

- *1 When the mode setting of CC-Link is Ver.1, the extension cyclic setting is not available. (Fixed to Single)
- *2 The remote READY flag is on during startup of the GOT.
 It switches on when GOT power is switched on, hardware reset is made, or the GOT is ready to operate.
 If GOT power is on, the remote READY flag is off when offline operation is performed (during OS installation or screen data downloading) or while initial processing is executed.
 Use it for the interlock ladder when writing or reading data to or from the CC-Link Master station.

3.2 Remote Register Assignment

The following is the assignment of the remote registers of the GOT.
The remote registers differ according to the set number of occupied stations (1 or 4 stations).

All areas are use areas.

m and n in the table indicate the addresses assigned to the Master module by station number setting.

Transfer Direction	Address				Description	Default Value
	Extension cyclic setting* ³					
	Single		Double			
	1 station occupied	4 station occupied	1 station occupied	4 station occupied		
Master station ↓ GOT	RWwm to RWwm+3	RWwm to RWwm+F	RWwm to RWwm+7	RWwm to RWwm+1F	User write area	0
GOT ↓ Master station	RWrn to RWrn+3	RWrn to RWrn+F	RWrn to RWrn+7	RWrn to RWrn+1F	User read area	0

Transfer Direction	Address				Description	Default Value
	Extension cyclic setting* ³					
	Quadruple		Octuple			
	1 station occupied	4 station occupied	1 station occupied	4 station occupied		
Master station ↓ GOT	RWwm to RWwm+F	RWwm to RWwm+3F	RWwm to RWwm+1F	RWwm to RWwm+7F	User write area	0
GOT ↓ Master station	RWrn to RWrn+F	RWrn to RWrn+3F	RWrn to RWrn+1F	RWrn to RWrn+7F	User read area	0

*3 When the mode setting of CC-Link is Ver.1, the extension cyclic setting is not available. (Fixed to Single)

4. PART NAMES AND EXTERNAL DIMENSIONS

GT15-J61BT13

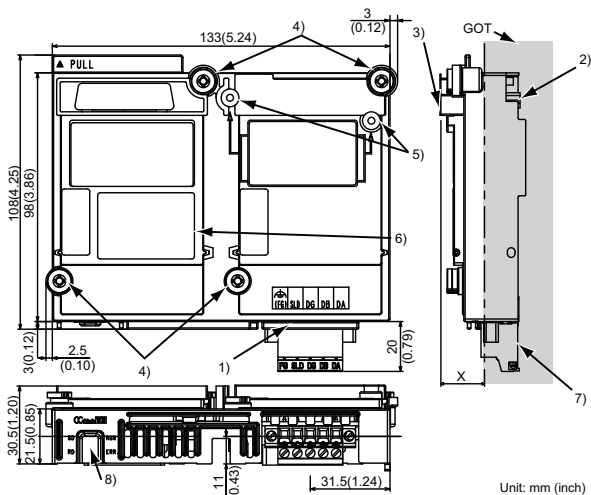

Unit: mm (inch)

Dimensions of X when the CC-Link communication unit is mounted to the GOT.

GOT	GT27	GT25	GT16	GT15
15"	23(0.91)	-	19.5(0.77)	21(0.83)
12.1"	23(0.91)	23(0.91)	18(0.71)	18(0.71)
10.4"	23(0.91)	23(0.91)	21(0.83)	21(0.83)
8.4"	23(0.91)	23(0.91)	23(0.91)	23(0.91)
5.7"	23(0.91)	-	23(0.91)	23(0.91)

Unit:mm(inch)

No.	Name	Description
1)	CC-Link communication connector	Connector for connecting the CC-Link dedicated cable
2)	Interface connector	Extension connector installed to a front extension unit or the GOT
3)	Extension connector	Extension connector to which a back extension unit is installed
4)	Mounting screw	Mounting screws fixed with a front extension unit or the GOT

No.	Name	Description																																											
5)	Board fixing screw	Screw for fixing the extension interface relay board																																											
6)	Rating plate	-																																											
7)	Terminal block socket	Socket for connecting the CC-Link dedicated cable to the CC-Link communication connector																																											
8)	<p>Operation indicator LED</p> <p>SD <input type="radio"/> <input type="radio"/> RUN</p> <p>RD <input type="radio"/> <input type="radio"/> ERR.</p>	<p>This indicates the status of the CC-Link communication unit and the communication status.</p> <p>The LED lighting status includes the normal mode and error mode.</p> <p>(1) Normal mode</p> <p>If any communication error occurs in the normal mode, specify the error cause by the [NETWK unit status display] screen. Refer to the User's Manual for the GOT used for details on the [NETWK unit status display] screen.</p> <p>(2) Error mode</p> <p>When the RUN LED is flickering, the LED indication will change to the error mode. If an error occurs in the error mode, restart the GOT.</p> <p>If the error mode is not released after restarting the GOT, the system alarm "460 Communication unit error" may have occurred. For system alarms, refer to the User's Manual for the GOT used.</p> <table border="1" data-bbox="547 331 923 958"> <thead> <tr> <th>LED name</th> <th>Status</th> <th>Details</th> </tr> </thead> <tbody> <tr> <td rowspan="2">RUN</td> <td>OFF</td> <td>The GOT is being reset.</td> </tr> <tr> <td>ON</td> <td>The unit is in a normal status.</td> </tr> <tr> <td rowspan="3">ERR.</td> <td>OFF</td> <td>The unit is in a normal status.</td> </tr> <tr> <td>ON</td> <td>The communication statuses of all stations are abnormal.</td> </tr> <tr> <td>Flicker</td> <td>A communication error has occurred at a station or a station number is duplicated.</td> </tr> <tr> <td rowspan="2">SD</td> <td>OFF</td> <td>Data have not been transmitted or the GOT is being reset.</td> </tr> <tr> <td>ON</td> <td>Data are being transmitted.</td> </tr> <tr> <td rowspan="2">RD</td> <td>OFF</td> <td>Data have not been received or the GOT is being reset.</td> </tr> <tr> <td>ON</td> <td>Data are being received.</td> </tr> </tbody> </table> <table border="1" data-bbox="547 1009 923 1351"> <thead> <tr> <th>LED name</th> <th>Status</th> <th>Details</th> </tr> </thead> <tbody> <tr> <td rowspan="2">RUN</td> <td>Flicker</td> <td>The error mode has been entered.</td> </tr> <tr> <td>ON OFF</td> <td>No errors</td> </tr> <tr> <td rowspan="2">ERR.</td> <td>OFF</td> <td>A starting error has not occurred.</td> </tr> <tr> <td>ON</td> <td>A starting error has occurred.</td> </tr> <tr> <td rowspan="2">RD</td> <td>OFF</td> <td>A hardware failure has not occurred.</td> </tr> <tr> <td>ON</td> <td>A hardware failure has occurred.</td> </tr> </tbody> </table>	LED name	Status	Details	RUN	OFF	The GOT is being reset.	ON	The unit is in a normal status.	ERR.	OFF	The unit is in a normal status.	ON	The communication statuses of all stations are abnormal.	Flicker	A communication error has occurred at a station or a station number is duplicated.	SD	OFF	Data have not been transmitted or the GOT is being reset.	ON	Data are being transmitted.	RD	OFF	Data have not been received or the GOT is being reset.	ON	Data are being received.	LED name	Status	Details	RUN	Flicker	The error mode has been entered.	ON OFF	No errors	ERR.	OFF	A starting error has not occurred.	ON	A starting error has occurred.	RD	OFF	A hardware failure has not occurred.	ON	A hardware failure has occurred.
LED name	Status	Details																																											
RUN	OFF	The GOT is being reset.																																											
	ON	The unit is in a normal status.																																											
ERR.	OFF	The unit is in a normal status.																																											
	ON	The communication statuses of all stations are abnormal.																																											
	Flicker	A communication error has occurred at a station or a station number is duplicated.																																											
SD	OFF	Data have not been transmitted or the GOT is being reset.																																											
	ON	Data are being transmitted.																																											
RD	OFF	Data have not been received or the GOT is being reset.																																											
	ON	Data are being received.																																											
LED name	Status	Details																																											
RUN	Flicker	The error mode has been entered.																																											
	ON OFF	No errors																																											
ERR.	OFF	A starting error has not occurred.																																											
	ON	A starting error has occurred.																																											
RD	OFF	A hardware failure has not occurred.																																											
	ON	A hardware failure has occurred.																																											

Extension interface relay board

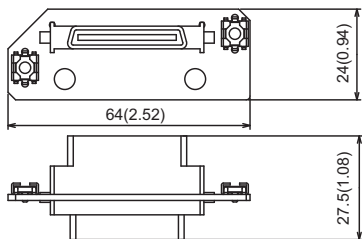

Unit:mm(inch)

5. INSTALLATION PROCEDURE

The installation procedure for the CC-Link communication unit is explained using the GT1575.

5.1 CC-Link communication unit installation

- (1) Power off the GOT.
- (2) Remove two extension unit covers of the GOT.

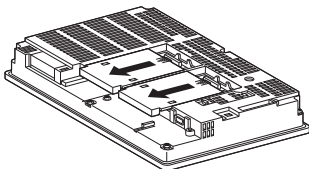

- (3) Attach the extend interface relay board to the extend I/F-2 side on the GOT.

After the installation, detach the connector cover from the extend interface relay board.

For the following GOT types, the extension interface relay board is not needed.

- GT1655,155□ of the GOT1000 series
- GT27,GT25 of the GOT2000 series

- (4) Fit the CC-Link communication unit in the GOT case.

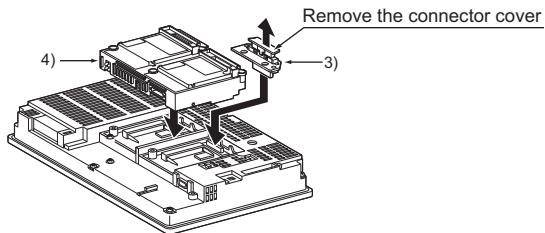

(5) Fasten the CC-Link communication unit by tightening its mounting screws (4 places) with tightening torque 0.36 to 0.48 N·m.

(6) Fasten the bus connection unit by tightening the board fixing screws (2 places) with the tightening torque of 0.36 to 0.48 N·m.

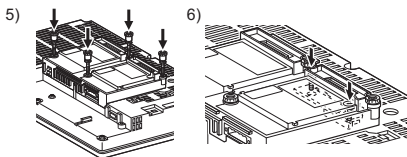

(7) When installing an extension unit on the unit that has been installed, remove the connector cover and the sticker.

When not installing an extension unit on the unit that has been installed, in order to avoid receiving electrostatic, stick accessory stickers to cover the top of mounting screws (4 places).

Keep the connector cover fixed.

Keep the sticker stuck as it is.

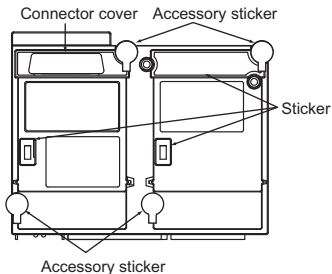

POINT

Remove the screws that fixes the extension interface relay board before removing the unit.(Above 6))

5.2 Terminal block socket installation

CAUTION

Be sure to fix the wires or cables by ducts or clamps when connecting them to the unit.

Not doing so can damage the unit or cables due to dangling, moved or accidentally pulled cables or can cause misoperation due to cable contact fault.

- (1) Insert the terminal block socket in the CC-Link communication unit.

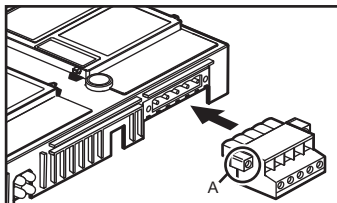

- (2) Fasten the terminal block by tightening the terminal block fixing screws (2 places) with the tightening torque of 0.7 to 0.8 N·m.
(Expanded figure of part A)

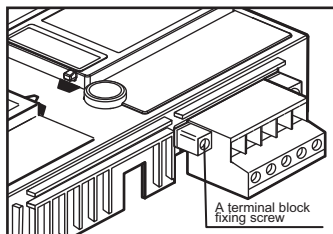

POINT

When attaching or removing a communication cable to/from the terminal block socket, detach the terminal block socket from the connector.

(When extension units are installed in multiple layers, the units do not have to be removed from the GOT main unit.)

6. WIRING METHOD

The following diagram shows how to wire the GOT and CC-Link system modules.

- (1) Wiring the GOT and CC-Link system modules by CC-Link dedicated cable

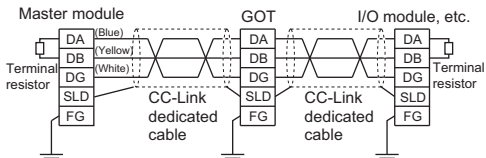

When connecting the CC-Link dedicated cables of the previous station and next station, strip the wire sheaths off for 10mm (0.39 inch) and insert the cables into the terminal block socket with every two wires in the same color together. When connecting the braid shields of the CC-Link dedicated cables of the previous station and the next station, caulk each braid shield to the supplied solderless terminal (Plate type), then insert the shields into the terminal block socket.

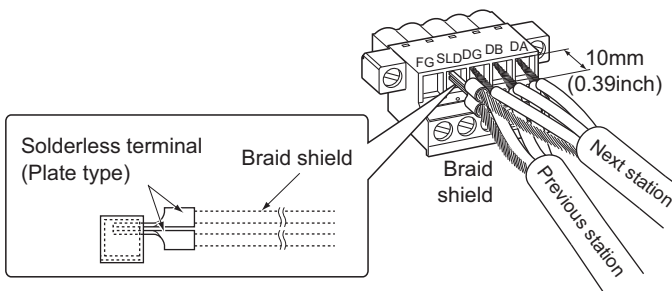

- (2) When connecting the terminating resistor and FG cable
 When connecting the terminating resistors to the GOT, be sure to connect the terminating resistors (with the supplied plate type solderless terminal) at the position as shown below.
 When connecting the FG cable, strip the wire sheath of the FG cable (2mm²) off for 10mm (0.39 inch) and insert it into the terminal block socket.

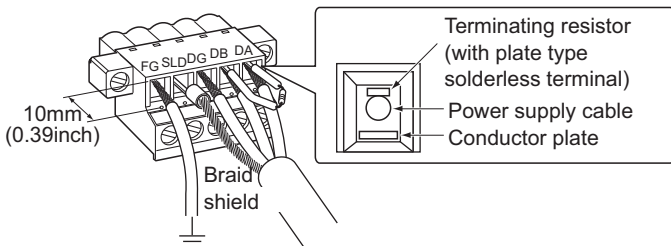

POINT

- Tighten the terminal block wiring screws with the tightening torque of 0.5 to 0.6 N·m.
- Tighten terminal block mounting screws with the tightening torque of 0.7 to 0.8 N·m.
- The terminating resistors supplied with the master module or the CC-Link communication unit must be connected to the PLC module or GOT at both ends of the data link. (Connect them across DA-DB.)
- Connect the shield wire of the CC-Link dedicated cable to SLD of each module. Since SLD is connected to FG internally, always ground the FG terminal and FG1 terminal to the protective ground conductor.
- The FG terminal of the GOT power supply and the FG terminal of the CC-Link Communication unit must be connected separately.
- When using the plate type solderless terminal, be sure to insert the terminal in the horizontal direction toward the terminal block. The solderless terminal may come off when it is inserted in the vertical direction.

Warranty

Mitsubishi Electric will not be held liable for damage caused by factors found not to be the cause of Mitsubishi Electric; machine damage or lost profits caused by faults in the Mitsubishi Electric products; damage, secondary damage, accident compensation caused by special factors unpredictable by Mitsubishi Electric; damages to products other than Mitsubishi Electric products; and to other duties.

For safe use

- This product has been manufactured as a general-purpose part for general industries, and has not been designed or manufactured to be incorporated in a device or system used in purposes related to human life.
- Before using the product for special purposes such as nuclear power, electric power, aerospace, medicine or passenger movement vehicles, consult with Mitsubishi Electric.
- This product has been manufactured under strict quality control. However, when installing the product where major accidents or losses could occur if the product fails, install appropriate backup or failsafe functions in the system.

Country/Region	Sales office/Tel	Country/Region	Sales office/Tel
USA	Mitsubishi Electric Automation, Inc. 500 Corporate Woods Parkway, Vernon Hills, IL 60061, U.S.A. Tel: +1-847-478-2100	South Africa	Adroit Technologies 20 Waterford Office Park, 189 Witkoppen Road, Fourways, South Africa Tel: +27-11-658-8100
Brazil	Mitsubishi Electric do Brasil Comercio e Servicos Ltda. Avenida Adelino Cardana, 293, 21 andar, Bethaville, Barueri SP, Brazil Tel: +55-11-4689-3000	China	Mitsubishi Electric Automation (China) Ltd. Mitsubishi Electric Automation Center, No.1386 Hongqiao Road, Shanghai, China Tel: +86-21-2322-3030
Mexico	Mitsubishi Electric Automation, Inc. Mexico Branch Boulevard Miguel de Cervantes Saavedra 301, Torre Norte Piso 5, Ampliacion Granada, Miguel Hidalgo, Ciudad de Mexico, Mexico, C.P. 11520 Tel: +52-55-3067-7512	Taiwan	SETSUYO ENTERPRISE CO., LTD. 6F, No.105, Wugong 3rd Road, Wugu District, New Taipei City 24889, Taiwan Tel: +886-2-2299-2499
Germany	Mitsubishi Electric Europe B.V. German Branch Mitsubishi-Electric-Platz 1, 40882 Ratingen, Germany Tel: +49-2102-486-0	Korea	Mitsubishi Electric Automation Korea Co., Ltd. 7F to 9F, Gangseo Hangang Xi-tower A, 401, Yangcheon-ro, Gangseo-Gu, Seoul 07528, Korea Tel: +82-2-3660-9569
UK	Mitsubishi Electric Europe B.V. UK Branch Travellers Lane, UK-Hatfield, Hertfordshire, AL10 8XB, U.K. Tel: +44-1707-28-8780	Singapore	Mitsubishi Electric Asia Pte. Ltd. 307 Alexandra Road, Mitsubishi Electric Building, Singapore 159943 Tel: +65-6473-2308
Italy	Mitsubishi Electric Europe B.V. Italian Branch Centro Direzionale Colleoni - Palazzo Sirio, Viale Colleoni 7, 20864 Agrate Brianza (MB), Italy Tel: +39-039-60531	Thailand	Mitsubishi Electric Factory Automation (Thailand) Co., Ltd. 12th Floor, SV City Building, Office Tower 1, No. 896/19 and 20 Rama 3 Road, Kwaeng Bangpongpan, Khet Yannawa, Bangkok 10120, Thailand Tel: +66-2682-6522 to 31
Spain	Mitsubishi Electric Europe B.V. Spanish Branch Carretera de Rubi, 76-80-Appdo. 420, E-08190 Sant Cugat del Valles (Barcelona), Spain Tel: +34-935-65-3131	Indonesia	PT. Mitsubishi Electric Indonesia Gedung Jaya 8th Floor, J.L. MH. Thamrin No.12, Jakarta Pusat 10340, Indonesia Tel: +62-21 3192-6461
France	Mitsubishi Electric Europe B.V. French Branch 25, Boulevard des Bouvets, 92741 Nanterre Cedex, France Tel: +33-1-55-68-55-68	Vietnam	Mitsubishi Electric Vietnam Company Limited 11th & 12th Floor, Viettel Tower B, 285 Cach Mang Thang 8 Street, Ward 12, District 10, Ho Chi Minh City, Vietnam. Tel: +84-28-3910-5945
Czech	Mitsubishi Electric Europe B.V. Czech Branch Pekarska 621/7, 155 00 Praha 5, Czech Republic Tel: +420-255 719 200	India	Mitsubishi Electric India Pvt. Ltd. Pune Branch Emerald House, EL-3, J Block, M.I.D.C., Bhosari, Pune - 411026, Maharashtra, India Tel: +91-20-2710-2000
Turkey	Mitsubishi Electric Turkey A.S. Umranije Branch Serifali Mahallesi Nutuk Sokak No:5, TR-34775 Umranije / Istanbul, Turkey Tel: +90-216-526-3990	Australia	MITSUBISHI ELECTRIC AUSTRALIA PTY. LTD. 348 Victoria Road, P.O. Box 11, Rydalmere, N.S.W 2116, Australia Tel: +61-2-9684-7777
Poland	Mitsubishi Electric Europe B.V. Polish Branch ul. Krakowska 48, 32-083 Balice, Poland Tel: +48-12-347-65-00		
Russia	Mitsubishi Electric (Russia) LLC St. Petersburg Branch Piskarevsky pr. 2, bld 2, lit "Sch", BC "Benua", office 720; 195027 St. Petersburg, Russia Tel: +7-812-633-3497		

MITSUBISHI ELECTRIC CORPORATION

HEAD OFFICE : TOKYO BUILDING, 2-7-3 MARUNOUCHI, CHYODA-KU, TOKYO 100-8310, JAPAN
NAGOYA WORKS : 1-14, YADA-MINAMI 5-CHOME, HIGASHI-KU, NAGOYA, JAPAN

When exported from Japan, this manual does not require application to the Ministry of Economy, Trade and Industry for service transaction permission.

Specifications subject to change without notice. Printed in Japan, November 2020.